

DO NOT SCALE FROM THIS PRINT

FSI-1XX-XX-XXX-D-X-XX-XX

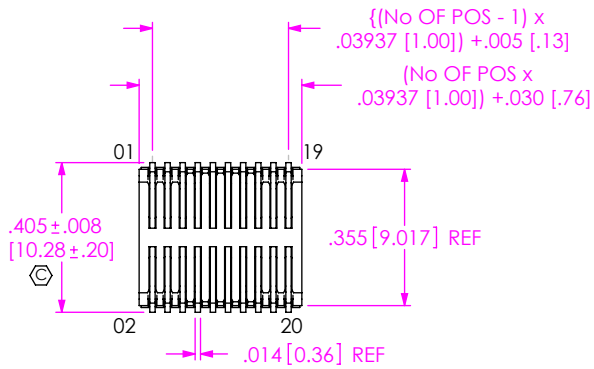

NO OF POSITIONS

THREADED: -10, -20, -25, -30, -40, -50
NON-THREADED: -05 THRU -50
[IN MULTIPLES OF 5]

BODY HEIGHT

-06: 6mm (USE C-133-02-XXX)
-10: 10mm (USE C-133-03-XXX)

PLATING

- L: .000010 GOLD ON CONTACT AREA, .000100-.000250 TIN ON TAIL (USE C-133-XX-L)
- S: .000030 GOLD ON CONTACT AREA, .000100-.000250 TIN ON TAIL (USE C-133-XX-S)
- STL: .000030 GOLD ON CONTACT AREA, .000200 TIN LEAD ON TAIL (USE C-133-XX-STL)
- LTL: .000010 GOLD ON CONTACT AREA, .000200 TIN LEAD ON TAIL (USE C-133-XX-LTL)
- LM: .000010 GOLD ON CONTACT AREA, .000100-.000250 MATTE TIN ON TAIL (USE C-133-XX-L)
- SM: .000030 GOLD ON CONTACT AREA, .000100-.000250 MATTE TIN ON TAIL (USE C-133-XX-S)

ROW SPECIFICATION

- D: DOUBLE ROW
(FOR -06 BODY: USE FSI-XX-06-D-XX-X)
(FOR -10 BODY: USE FSI-XX-10-D-XX-X)

OPTION

- TR: TAPE & REEL PACKAGING BLANK FOR TUBED PARTS.
- P: (FOR AVAILABILITY, SEE FIG 4, SHEET 3)
- K: POLYAMIDE FILM PAD (USE K-500-300) (SEE FIG 5, SHEET 3) [AVAILABLE ONLY ON POSITIONS 40 & 50 WITH ANY THREADED INSERT OPTIONS]

ALIGNMENT PIN LOCATION

- AT: TOP SIDE (USE FSI-XX-XX-D-AT-X)
- AB: BOTTOM SIDE (USE FSI-XX-XX-D-AB-X)
- AD: DUAL (TOP & BOTTOM) (USE FSI-XX-XX-D-AD-X, SEE FIG 2)
- *-LC: LOCKING CLIP BLANK FOR NO ALIGNMENT PIN.

THREADED INSERT OPTION

- E: THREADED INSERT (ENGLISH) (USE INS-19-2-56-157, SEE FIG 3, SHT 2)
- M: THREADED INSERT (METRIC) (USE INS-19-M2-157-N, SEE FIG 3, SHT 2)
- BLANK FOR NON-THREADED INSERT.

* = NOT TOOLED

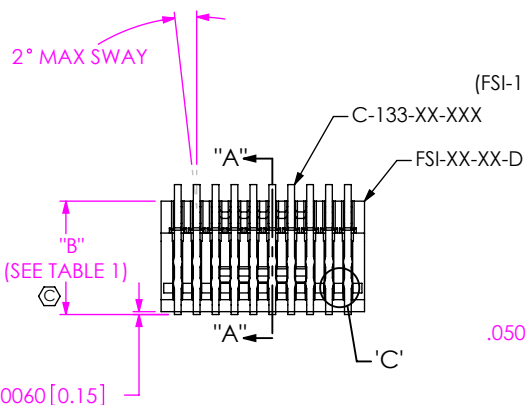

FIG 1
(FSI-110-06-XXX-D SHOWN)

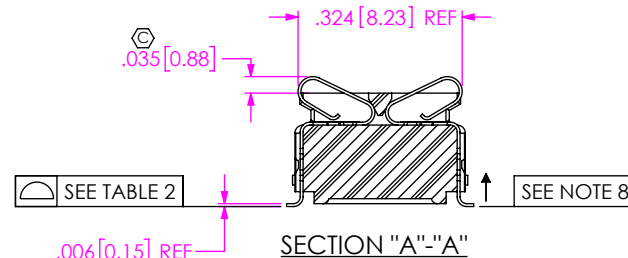
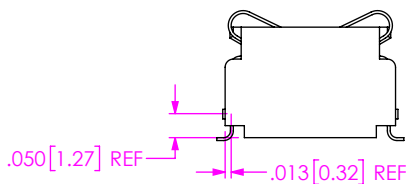
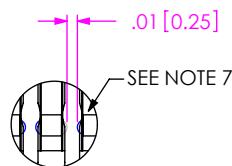

TABLE 1			
BODY HEIGHT	"B"	"C"	"D"
-06	.236 [6.00]	.450 [11.43]	.158 [4.01]
-10	.394 [10.00]	.450 [11.43]	.307 [7.80]

TABLE 2 Ⓢ	
No. OF POS.	COPLANARITY
0-35	.004 [.10]
40-50	.006 [.15]



DETAIL 'C'
SCALE 5.5 : 1

NOTES:

1. Ⓢ REPRESENTS A CRITICAL DIMENSION.
2. MINIMUM PUSHOUT FORCE: 12 oz.
3. LOAD INSERTS IN THE DIRECTION OF THE ARROW USING THERMAL INSERTION MACHINE.
4. THREADED INSERT MUST BE ABLE TO HANDLE 35 in.-oz's OF TORQUE MIN WITHOUT ROTATING OR "LOOSENING".
5. THREADED INSERT RETENTION TO BE 20 lb MIN.
6. FOR -05 POS WITH -PPP OPTION, LEADS MAY NOT BE VISIBLE BY SOME OPTICAL MACHINES.
7. HOT BAR FORM AFTER ASSEMBLY (WILL PRODUCE RETENTION FLANGE AS SHOWN).
8. MAXIMUM ALLOWABLE SHEAR BURR: .003[.08], IN DIRECTION SHOWN.

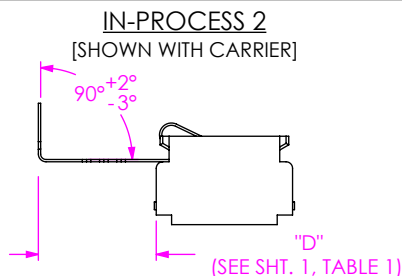
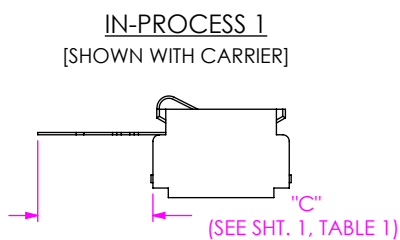
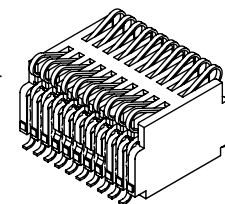

UNLESS OTHERWISE SPECIFIED, DIMENSIONS ARE IN INCHES.

TOLERANCES ARE:

DECIMALS ANGLES
.XX: ±.01 [.25] 2°
.XXX: ±.005 [.13]
.XXXX: ±.0020 [.05]

PROPRIETARY NOTE
THIS DOCUMENT CONTAINS CONFIDENTIAL AND PROPRIETARY INFORMATION AND ALL DESIGN, MANUFACTURING, REPRODUCTION, USE, PATENT RIGHTS AND SALES RIGHTS ARE EXPRESSLY RESERVED BY SAMTEC, INC. THIS DOCUMENT SHALL NOT BE DISCLOSED, IN WHOLE OR PART, TO ANY UNAUTHORIZED PERSON OR ENTITY NOR REPRODUCED, TRANSFERRED OR INCORPORATED IN ANY OTHER PROJECT IN ANY MANNER WITHOUT THE EXPRESS WRITTEN CONSENT OF SAMTEC, INC.

MATERIAL: DO NOT SCALE DRAWING SHEET SCALE: 2:1

INSULATOR: LCP, COLOR: BLACK
CONTACTS: C-133-02-X: BeCu
C-133-03-X: BeCu

INSERT: BRASS

F:\DWG\MISC\MKTG\FSI-1XX-XX-XXX-D-X-XX-XX-MKT.SLDDRW

DESCRIPTION:
1mm SINGLE ELEMENT INTERFACE

DWG. NO.
FSI-1XX-XX-XXX-D-X-XX-XX

BY: BRATCHER 1/29/99 SHEET 1 OF 3



520 PARK EAST BLVD, NEW ALBANY, IN 47150
PHONE: 812-944-6733 FAX: 812-948-5047
e-Mail: info@SAMTEC.com code: 55322

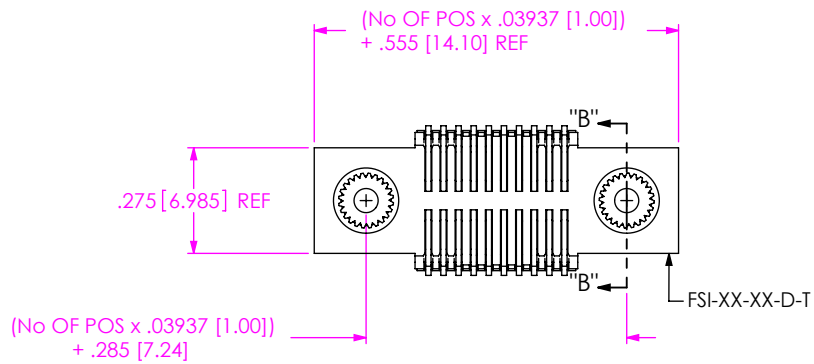

FIG 3
 -M & -E: THREADED OPTIONS
 (FSI-110-06-L-D-M SHOWN)
 (EQUATIONS APPLY TO -10, -20, -25 & -30 ONLY)

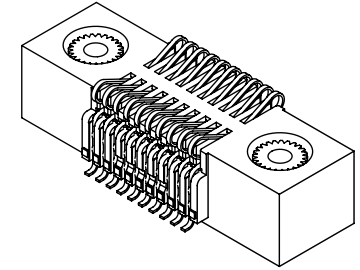
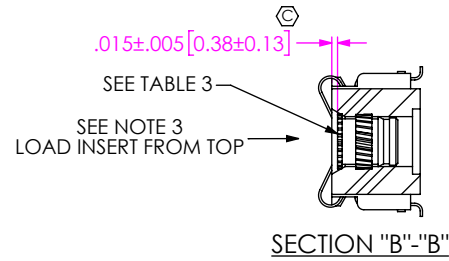

TABLE 3: THREADED INSERT

OPTION	INSERT	THREAD
-E	INS-19-2-56-157	2 X 56
-M	INS-19-M2-157-N	M2.0 x 4

**** METRIC THREADED INSERTS TO BE FLASH NICKEL PLATED**

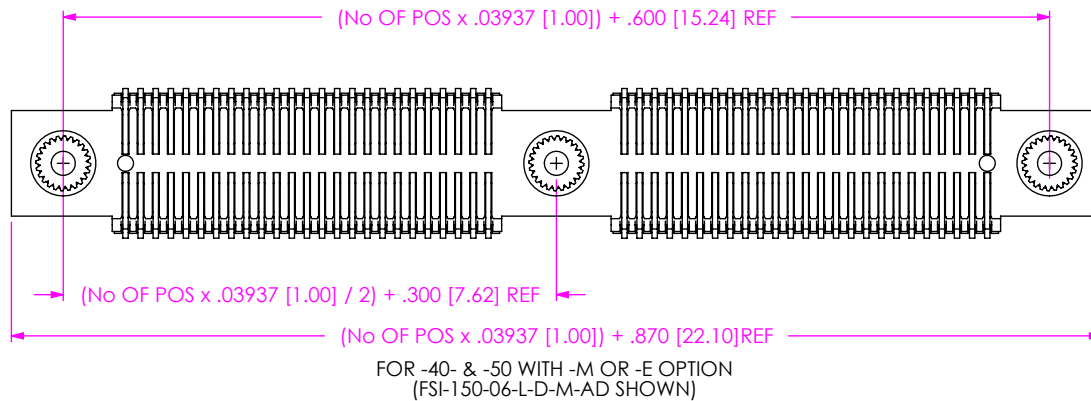
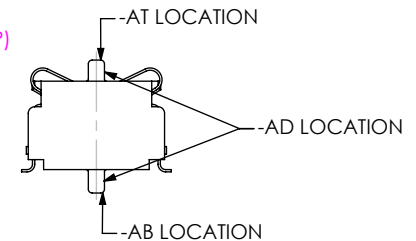
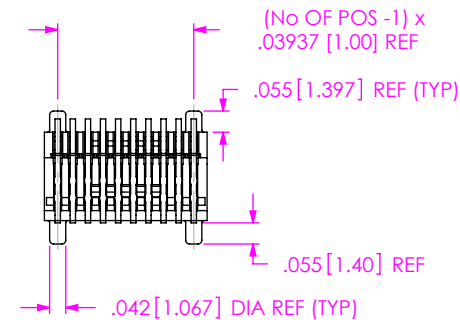
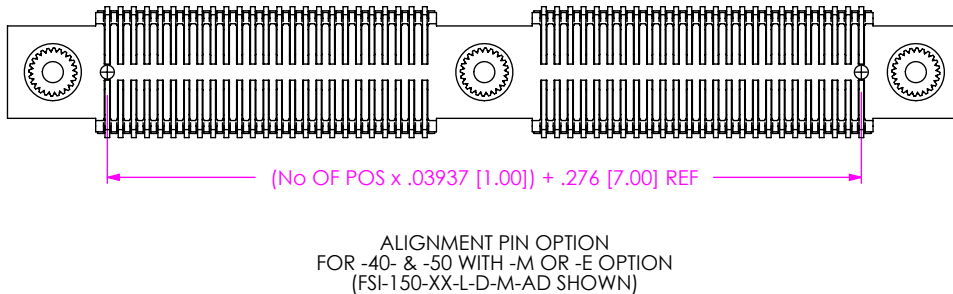

FIG 2
ALIGNMENT PIN OPTIONS
 (FSI-110-06-L-D-AD SHOWN)



PROPRIETARY NOTE
 THIS DOCUMENT CONTAINS CONFIDENTIAL AND PROPRIETARY INFORMATION AND ALL DESIGN, MANUFACTURING, REPRODUCTION, USE, PATENT RIGHTS AND SALES RIGHTS ARE EXPRESSLY RESERVED BY SAMTEC, INC. THIS DOCUMENT SHALL NOT BE DISCLOSED, IN WHOLE OR PART, TO ANY UNAUTHORIZED PERSON OR ENTITY NOR REPRODUCED, TRANSFERRED OR INCORPORATED IN ANY OTHER PROJECT IN ANY MANNER WITHOUT THE EXPRESS WRITTEN CONSENT OF SAMTEC, INC.

DO NOT SCALE DRAWING
 SHEET SCALE: 2:1



520 PARK EAST BLVD, NEW ALBANY, IN 47150
 PHONE: 812-944-6733 FAX: 812-948-5047
 e-Mail: info@SAMTEC.com code: 55322

DESCRIPTION:
 1mm SINGLE ELEMENT INTERFACE
 DWG. NO.
FSI-1XX-XX-XXX-D-X-XX-XX
 BY: BRATCHER 1/29/99 SHEET 2 OF 3

FIG 4

-P: PICK & PLACE PAD OPTION
(FSI-110-06-L-D-M SHOWN)
NOT AVAILABLE ON 5 POSITION

NOT AVAILABLE IF POSITION IS 05 AND LEAD STYLE IS 06

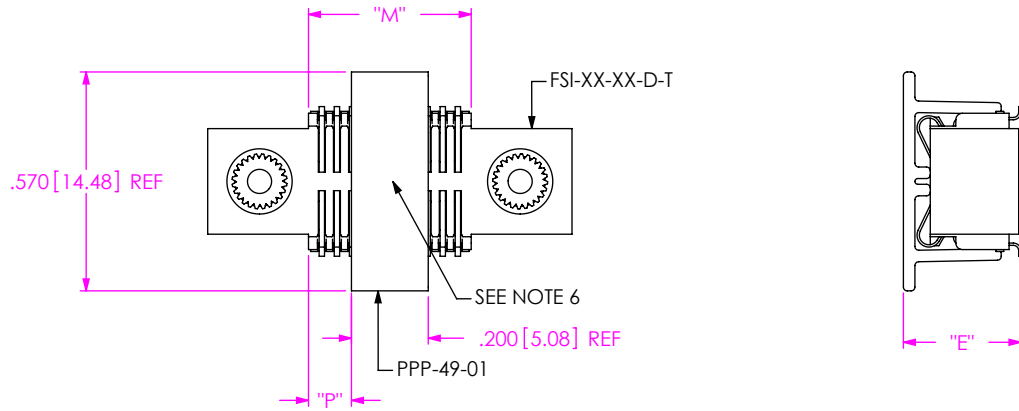

FOR 10 THRU 50 POSITIONS WITH -M OR -E OPTION,
-10 THRU -50 WITHOUT -M OR -E OPTION

"M" = (No OF POS x .03937[1.000]) + .030[.76] REF
"P" = {"M" - .200[5.08]} / 2 ± .020[.51]

TABLE 4

BODY HEIGHT	"E"	"F"
-06	.306 [7.77]	.241 [6.12]
-10	.464 [11.79]	.399 [10.13]

PT-1-24-02-70

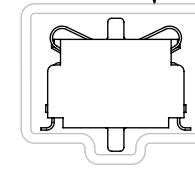

PT-1-24-02-106

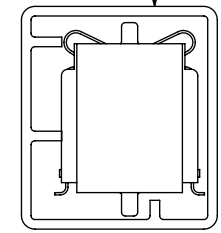

PT-1-24-03-101

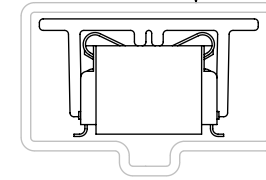

PT-1-24-04-101

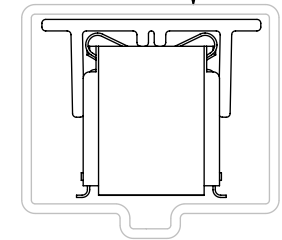

PACKAGING TABLE

BODY HEIGHT	TUBE	PLUG
-06	PT-1-24-02-70	TP-29
-10	PT-1-24-02-106	TP-13
-06-P	PT-1-24-03-101	TP-03
-10-P	PT-1-24-04-101	TP-13

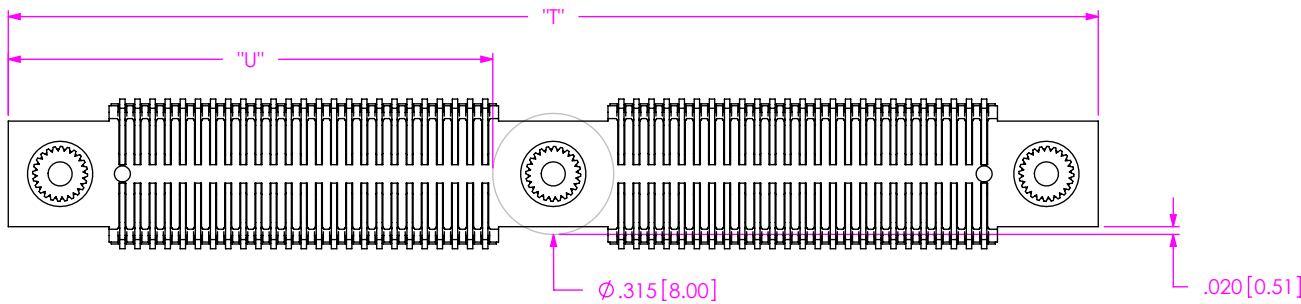

FIG 5

-K: POLYAMIDE FILM PAD
(USE K-500-300)
(AVAILABLE ONLY ON POSITIONS
40 & 50 WITH -M OR -E OPTION)

"T" = (No OF POS x .03937[1.000]) + .870[22.10] REF
"U" = {"T" - .315[8.00]} / 2 ± .020[.51]

PROPRIETARY NOTE

THIS DOCUMENT CONTAINS CONFIDENTIAL AND PROPRIETARY INFORMATION AND ALL DESIGN, MANUFACTURING, REPRODUCTION, USE, PATENT RIGHTS AND SALES RIGHTS ARE EXPRESSLY RESERVED BY SAMTEC, INC. THIS DOCUMENT SHALL NOT BE DISCLOSED, IN WHOLE OR PART, TO ANY UNAUTHORIZED PERSON OR ENTITY NOR REPRODUCED, TRANSFERRED OR INCORPORATED IN ANY OTHER PROJECT IN ANY MANNER WITHOUT THE EXPRESS WRITTEN CONSENT OF SAMTEC, INC.

DO NOT SCALE DRAWING

SHEET SCALE: 2:1

samtec

520 PARK EAST BLVD, NEW ALBANY, IN 47150
PHONE: 812-944-6733 FAX: 812-948-5047
e-Mail: info@SAMTEC.com code: 55322

DESCRIPTION: 1mm SINGLE ELEMENT INTERFACE

DWG. NO. FSI-1XX-XX-XXX-D-X-XX-XX

BY: BRATCHER 1/29/99 SHEET 3 OF 3