

REVISIONS				
P	LTR	DESCRIPTION	DATE	OWN / APVD
G		REVISED PER ECO-20-002047	20FEB2020	RK / MZ

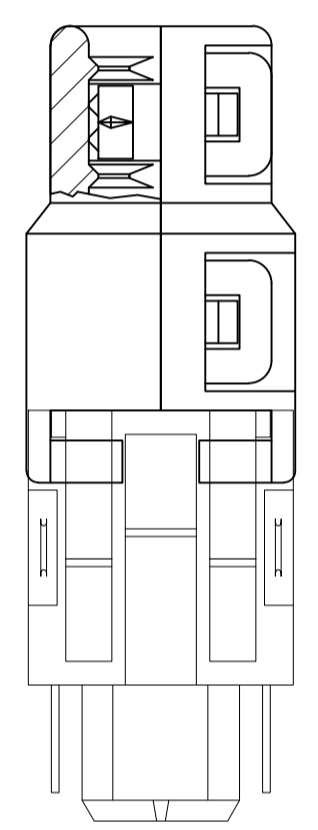

ASSEMBLED VIEW

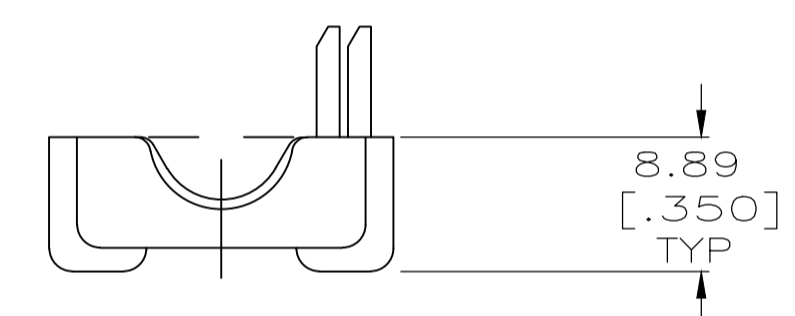
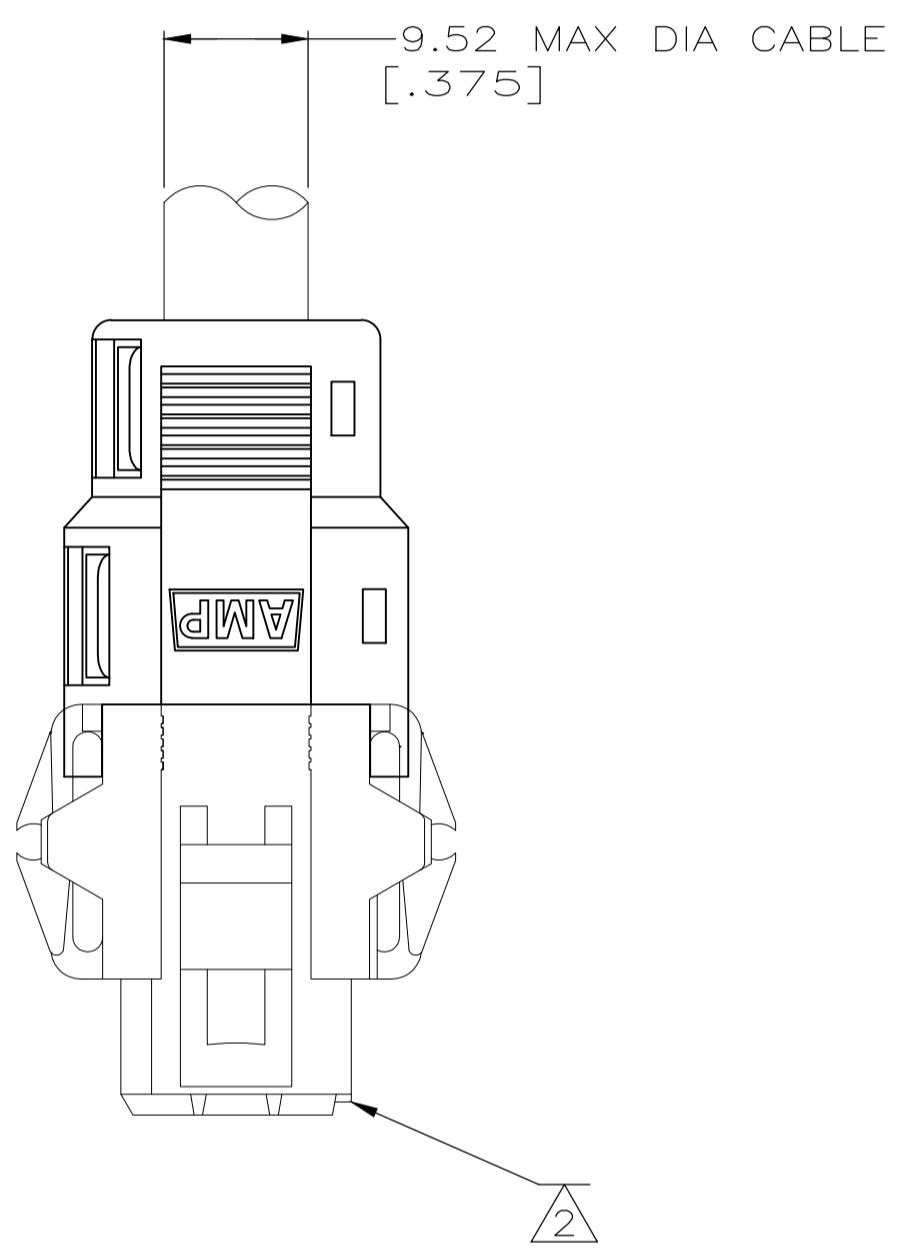
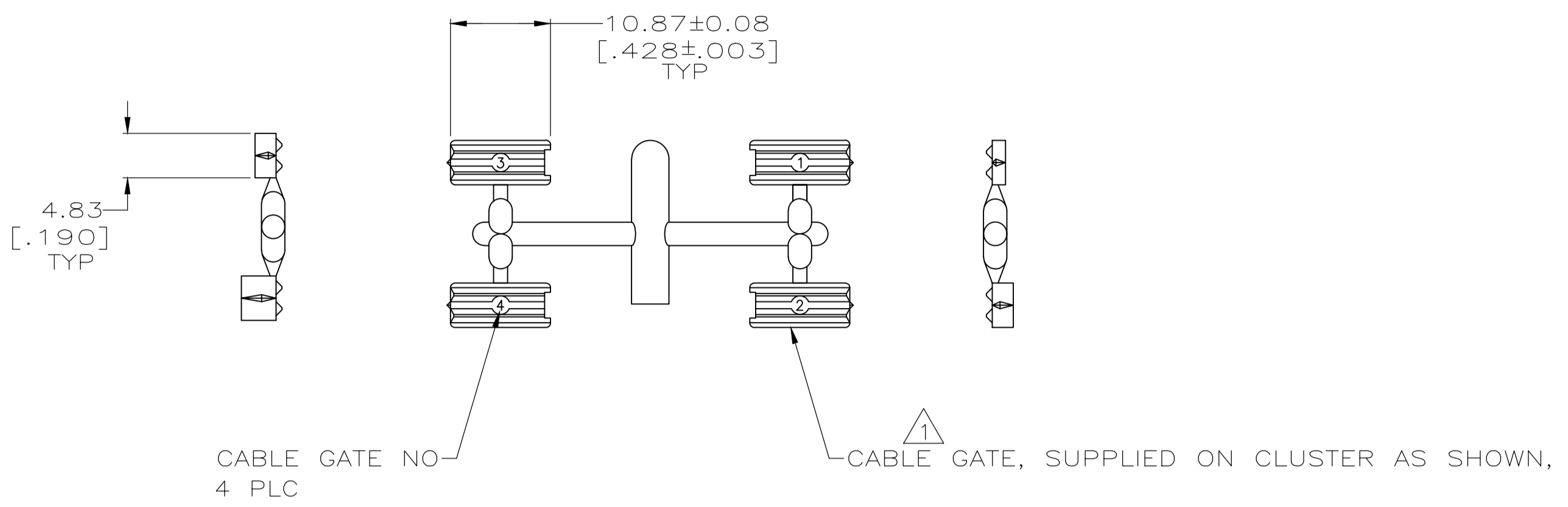
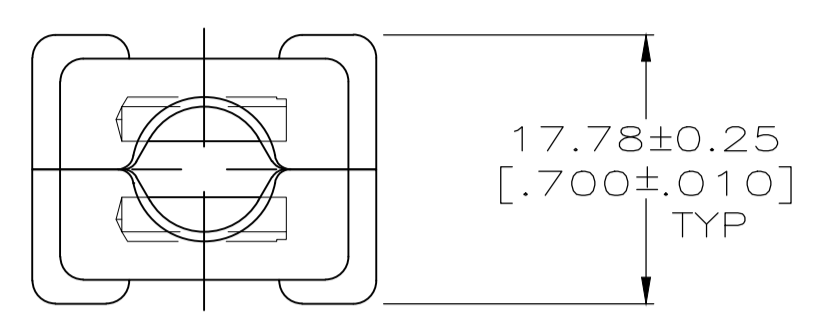
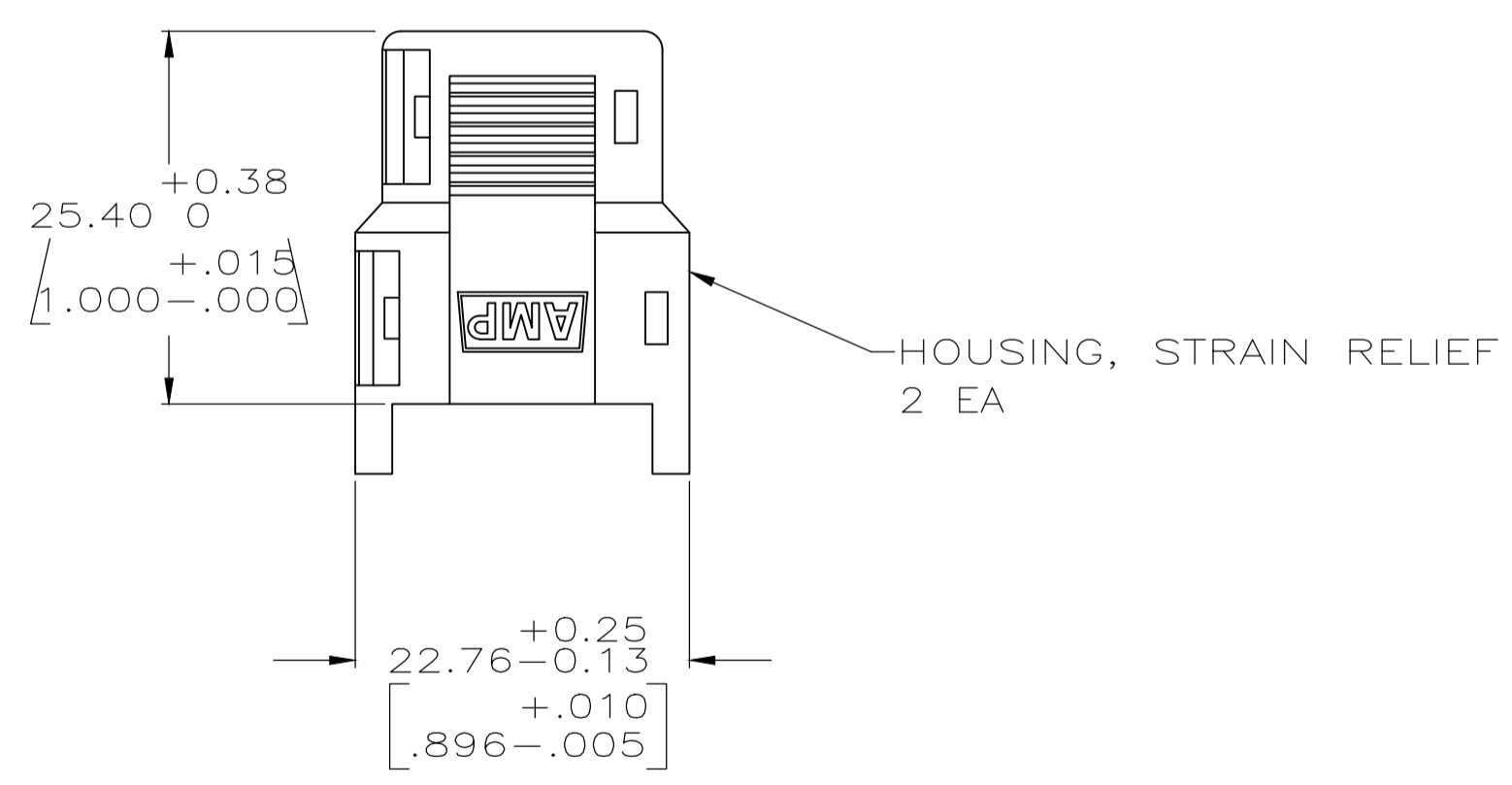
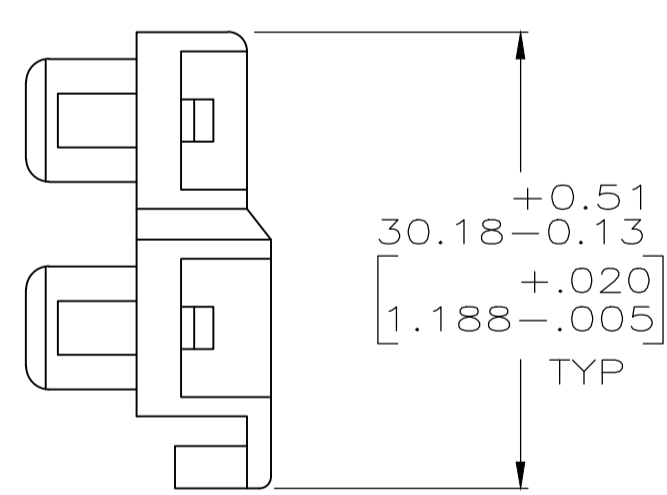

- ⚠ A VARIETY OF CABLE GATES ARE PROVIDED TO ACCOMMODATE A VARIETY OF CUSTOMER CABLE SIZES.
- ⚠ PLUG SHOWN FOR REFERENCE ONLY. STRAIN RELIEF CAN BE USED ON EITHER PLUG OR RECEPTACLE.
- ⚠ HOUSING MATERIAL: PA66, BLACK, UL 94 V-0 RATED.

207600-1  
PART NUMBER

THIS DRAWING IS A CONTROLLED DOCUMENT.		DIN J McCLINTON 1-26-92		TE Connectivity	
DIMENSIONS: INCHES		CIRK R STONE 1-29-92		NAME	
TOLERANCES UNLESS OTHERWISE SPECIFIED:		APVD		PRODUCT SPEC	
0 PLC ± -	1 PLC ± -	-		108-10033	
2 PLC ± 0.13[.005]	3 PLC ± -	APPLICATION SPEC		-	
4 PLC ± -	ANGLES ± -	SIZE		CAGE CODE DRAWING NO	
MATERIAL	FINISH	WEIGHT		RESTRICTED TO	
		A1 00779 C=207600		-	
CUSTOMER DRAWING				SCALE 2:1	SHEET 1 OF 1