

Specification

- Part No. : **TG.08.0723**
- Product Name : Cellular and GPS/GLONASS/GALILEO/BEIDOU
Hinged Fakra Connector Mount Antenna
- Features : Compact Passive Monopole Antenna
High Efficiencies at Cellular and GNSS frequencies
Fits in places other antennas just don't
360° rotatable with durable brass hinge
Compatible with:
 - 2G (GSM / DCS / PCS)
 - 3G (CDMA / WCDMA / UMTS / HSPA)
 - 4G (LTE)
 - GNSS (GPS / GLONASS / GALILEO/ BEIDOU)Fakra Code D Bordeaux Violet SMB(F) Connector
Length: 79.5mm
ROHS Compliant



1. Introduction

The compact TG.08 with hinged rotatable Fakra Code D connector is a monopole antenna for automotive telematics applications that provides wide coverage among cellular and GNSS frequencies and offers impressively high efficiencies. It fits in crowded device environments.

It's robust brass hinge enables TG.08 to be oriented in all directions, allowing users to maximize performance with minimum effort. The Fakra connector gives additional mechanical robustness over a traditional SMA connector since it locks securely with its mate and will not come loose due to vibrations or impacts.

This 72mm long monopole antenna has good efficiency in the 700MHz to 2700MHz range, covering the 2G/3G/4G bands, as well as GPS/GLONASS/BEIDOU. When connected to a ground plane, it can achieve up to 75% efficiency at GPS and LTE bands.

With its cellular and GNSS function, plus compact design, TG.08 is a great antenna for routers, vehicle tracking devices, telematic devices, and remote monitoring systems. It is also ideal for use in cellular modules with Assisted GPS functionality that can be implemented in various devices.

As with all monopole antennas, TG.08 works best when connecting directly to the ground-plane of the device main-board or to the device's metal enclosure. For optimum radiation efficiency care should be taken to keep the radiating element of the antenna as far away from metal as possible.



2. Specification

Parameter										
Straight Position										
Band		700LTE	GSM	BEIDOU	GPS	GLONASS	DCS	PCS	UMTS/ HSPA	2700LTE
Frequency (MHz)		703~ 803	824~ 960	1561	1575.42	1602	1710~ 1880	1850~ 1990	1920~ 2170	2490~ 2690
Average Gain (dBi)	In Free Space	-7.08	-3.34	-2.69	-2.64	-2.19	-2.27	-2.36	-2.47	-4.08
Efficiency (%)		19.93	46.55	53.87	54.45	60.38	59.31	58.12	56.62	39.81
Peak Gain (dBi)		-1.96	1.82	1.87	1.88	2.30	3.43	3.55	3.55	3.62
Return Loss (dB)		< -2	< -4	< -9	< -8	< -8	< -10	< -8	< -5	< -3
Average Gain (dBi)	With 15x9cm Ground	-2.16	-2.40	-2.01	-1.92	-1.67	-2.74	-2.42	-2.37	-6.30
Efficiency (%)		61.04	57.99	63.01	64.29	68.15	53.30	57.34	58.00	23.88
Peak Gain (dBi)		1.61	1.55	2.00	2.04	2.20	2.99	3.95	4.72	0.54
Return Loss (dB)		< -8	< -5	< -10	< -10	< -10	< -6	< -6	< -7	< -2
Average Gain (dBi)	On 30x30cm Ground Metal Edge	-1.76	-1.80	-1.06	-1.19	-1.15	-1.66	-1.22	-1.19	-4.03
Efficiency (%)		67.10	66.26	78.34	75.97	76.77	68.30	75.58	76.02	40.15
Peak Gain (dBi)		2.09	1.35	4.27	4.18	4.37	3.48	3.70	4.28	3.65
Return Loss (dB)		< -8	< -6	< -10	< -10	< -10	< -9	< -10	< -10	< -4
Average Gain (dBi)	On 30x30cm Ground Metal Center	-3.49	-1.98	-3.43	-3.37	-3.35	-3.34	-2.95	-2.66	-2.44
Efficiency (%)		46.33	63.95	45.36	46.07	46.20	46.41	50.82	54.33	57.42
Peak Gain (dBi)		1.37	2.52	1.47	1.50	1.43	1.17	1.76	2.68	3.40
Return Loss (dB)		< -3	< -4	< -6	< -5	< -5	< -3	< -3	< -4	< -6

Bent Position										
Average Gain (dBi)	In Free Space	-7.45	-3.54	-2.56	-2.54	-2.14	-2.30	-2.42	-2.57	-4.29
Efficiency (%)		18.25	44.69	55.42	55.66	61.13	58.87	57.24	55.32	37.76
Peak Gain (dBi)		-2.75	1.68	2.17	2.19	2.57	3.28	3.41	3.41	3.26
Return Loss (dB)		< -2	< -4	< -8	< -7	< -7	< -10	< -8	< -4	< -3
Average Gain (dBi)	With 15x9cm Ground	-2.52	-2.01	-2.10	-1.97	-1.68	-2.62	-2.34	-2.31	-6.36
Efficiency (%)		56.59	63.28	61.62	63.50	67.92	54.71	58.37	58.73	23.51
Peak Gain (dBi)		1.47	1.55	2.40	2.44	2.62	3.05	4.04	4.67	0.35
Return Loss (dB)		< -5	< -7	< -10	< -10	< -10	< -7	< -7	< -8	< -2
Average Gain (dBi)	On 30x30cm Ground Metal Edge	-2.22	-1.43	-1.06	-1.21	-1.14	-1.65	-1.24	-1.22	-3.29
Efficiency (%)		61.30	72.15	78.32	75.76	76.86	68.38	75.28	75.55	47.63
Peak Gain (dBi)		2.46	2.50	3.94	3.81	3.87	3.04	3.97	4.44	4.37
Return Loss (dB)		< -6	< -7	< -10	< -10	< -10	< -9	< -10	< -10	< -4
Average Gain (dBi)	On 30x30cm Ground Metal Center	-6.65	-3.06	-2.28	-2.34	-2.44	-3.00	-2.82	-2.61	-2.71
Efficiency (%)		23.10	49.79	59.19	58.34	56.99	50.15	52.34	54.95	54.27
Peak Gain (dBi)		-0.80	1.78	2.03	1.93	1.79	1.56	1.87	2.69	3.30
Return Loss (dB)		< -1	< -4	< -9	< -8	< -7	< -4	< -4	< -4	< -8
Radiation	Omni-directional									
Polarization	Linear									
Impedance	50 Ω									
Input Power	10W									
MECHANICAL										
Antenna length	79.5mm									
Antenna Diameter	5mm									
Casing	POM									
Connector	Fakra Code D									
Weight	8.5g									
ENVIRONMENTAL										
Operation Temperature	-40°C ~ + 85°C									
Storage Temperature	-40°C ~ + 85°C									
Humidity	Non-condensing 65°C 95% RH									

1. Antenna Characteristics

3.1 Testing setup

Straight Antenna Position

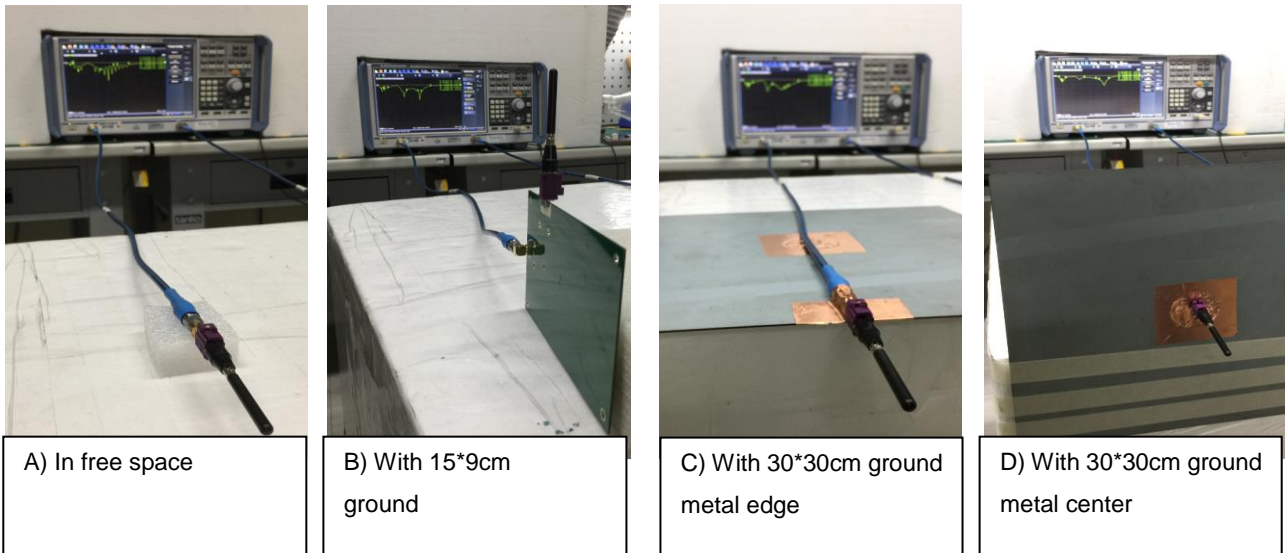

Bent Antenna Position

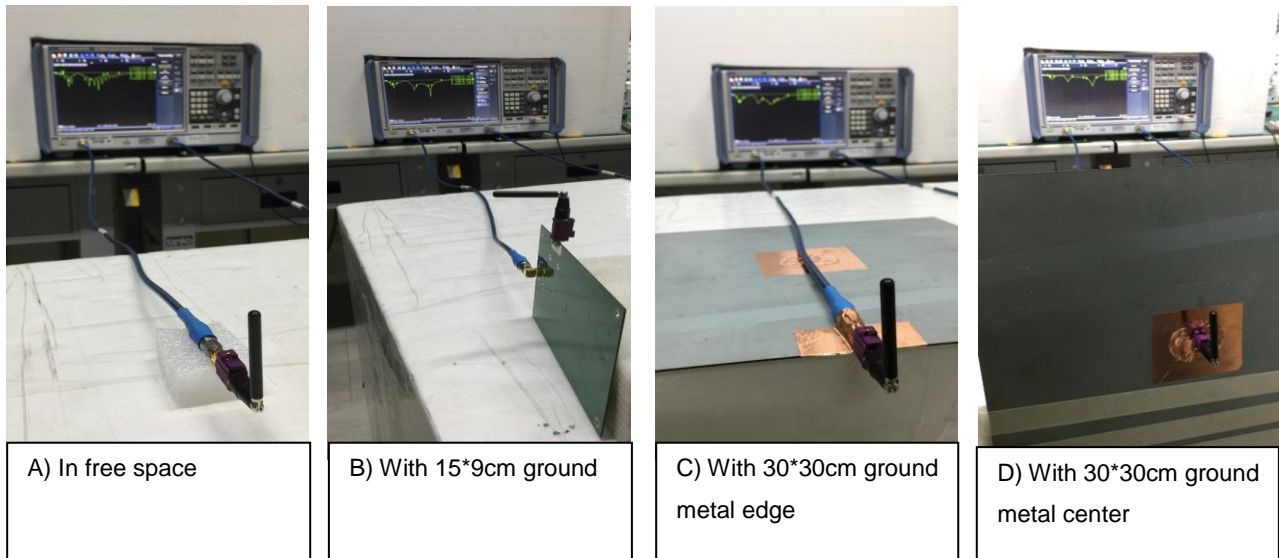

Figure 1. Measurement Environments

● **Return Loss**

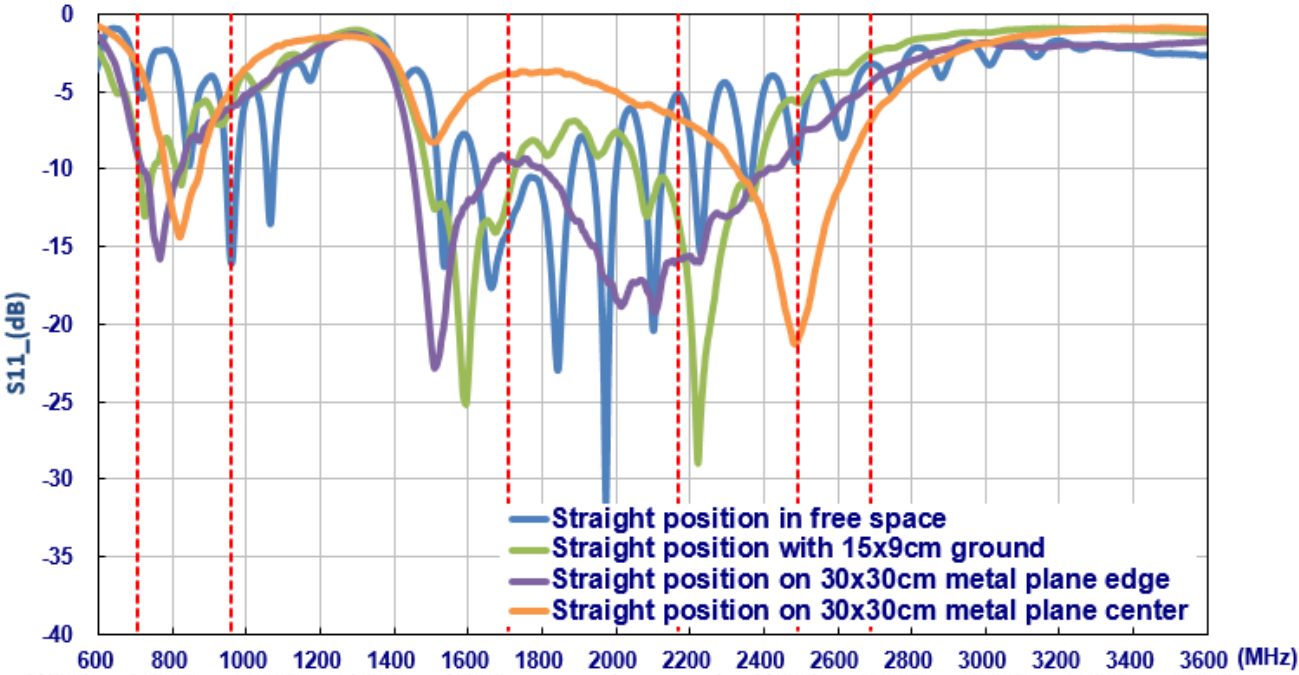

Figure 2. Return Loss of TG.08 antenna in straight position

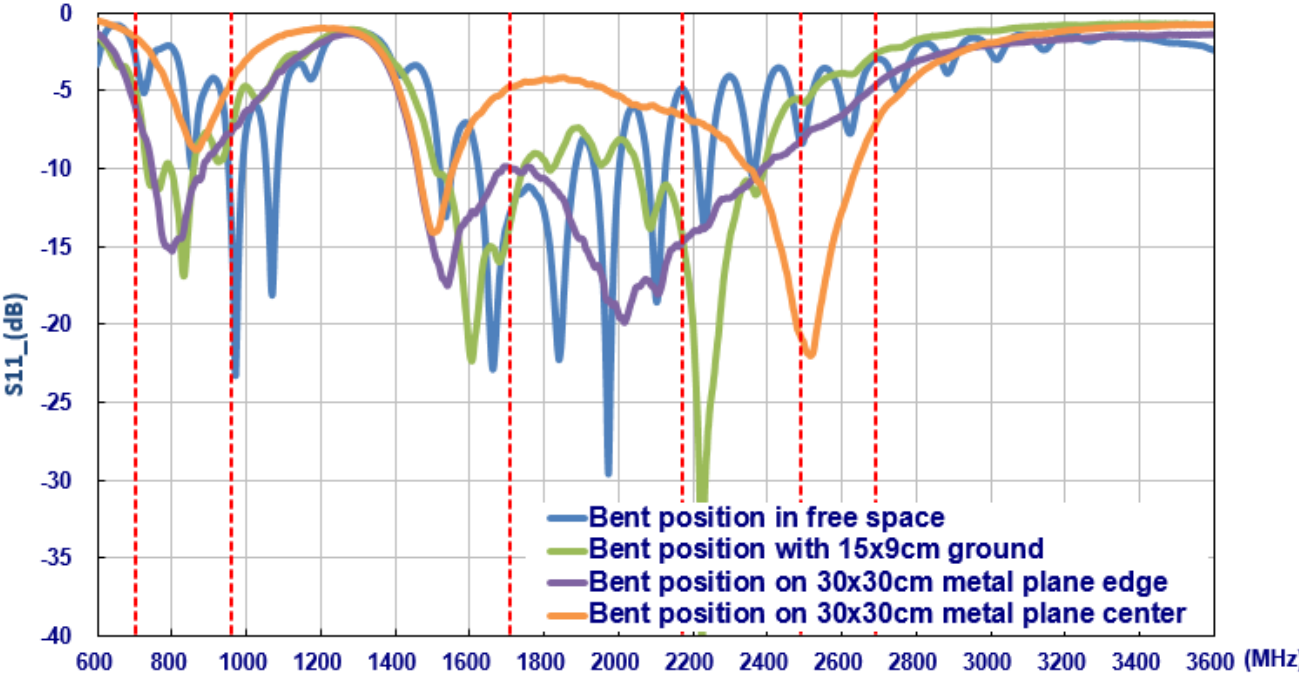

Figure 3. Return loss of TG.08 antenna in bent position

● **Efficiency**

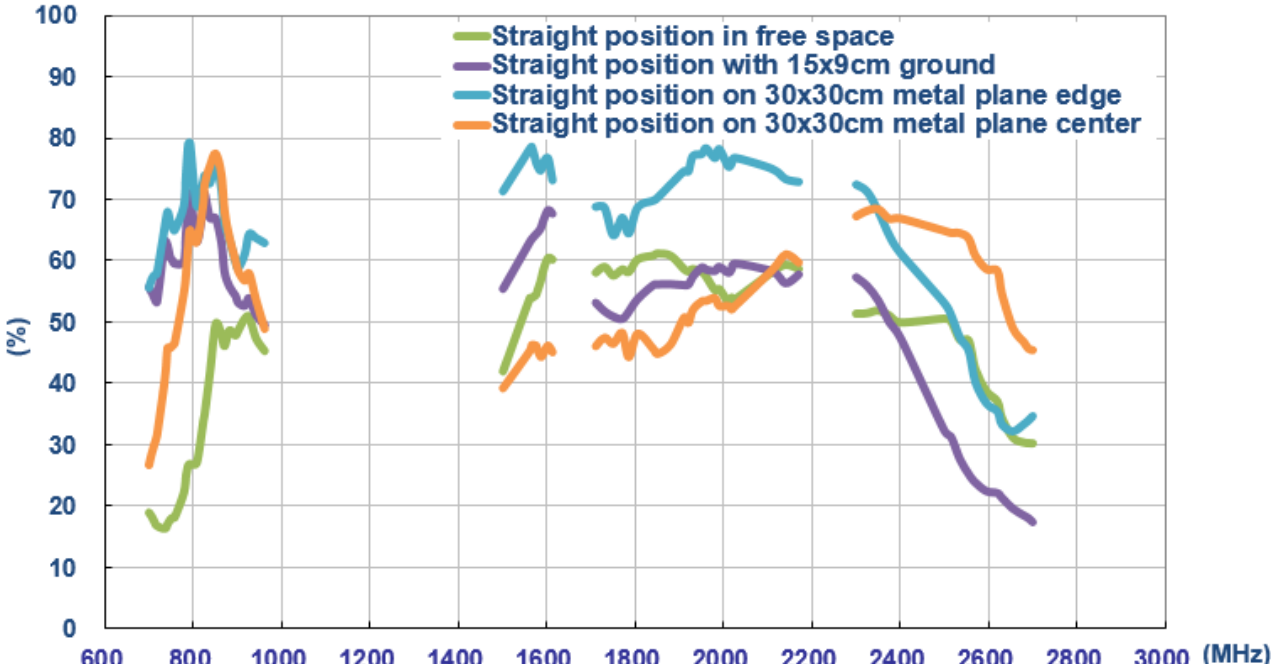

Figure 4. Efficiency of TG.08 antenna in straight position

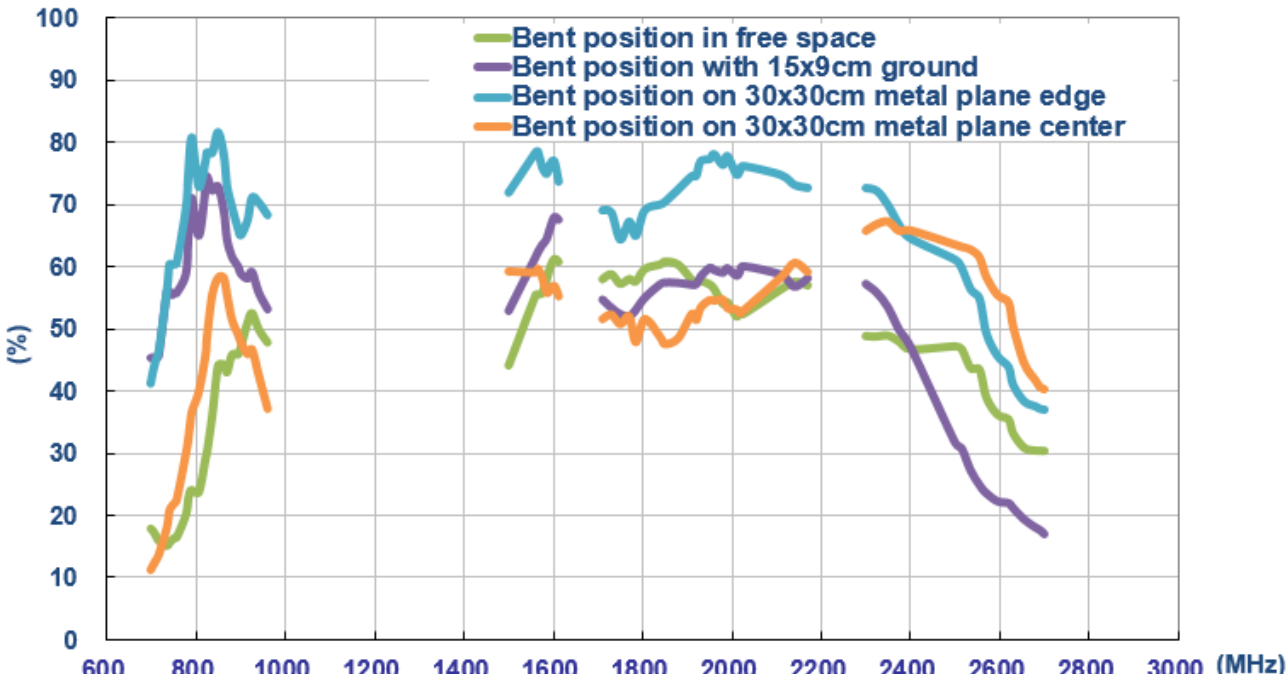

Figure 5. Efficiency of TG.08 antenna in bent position

● Peak Gain

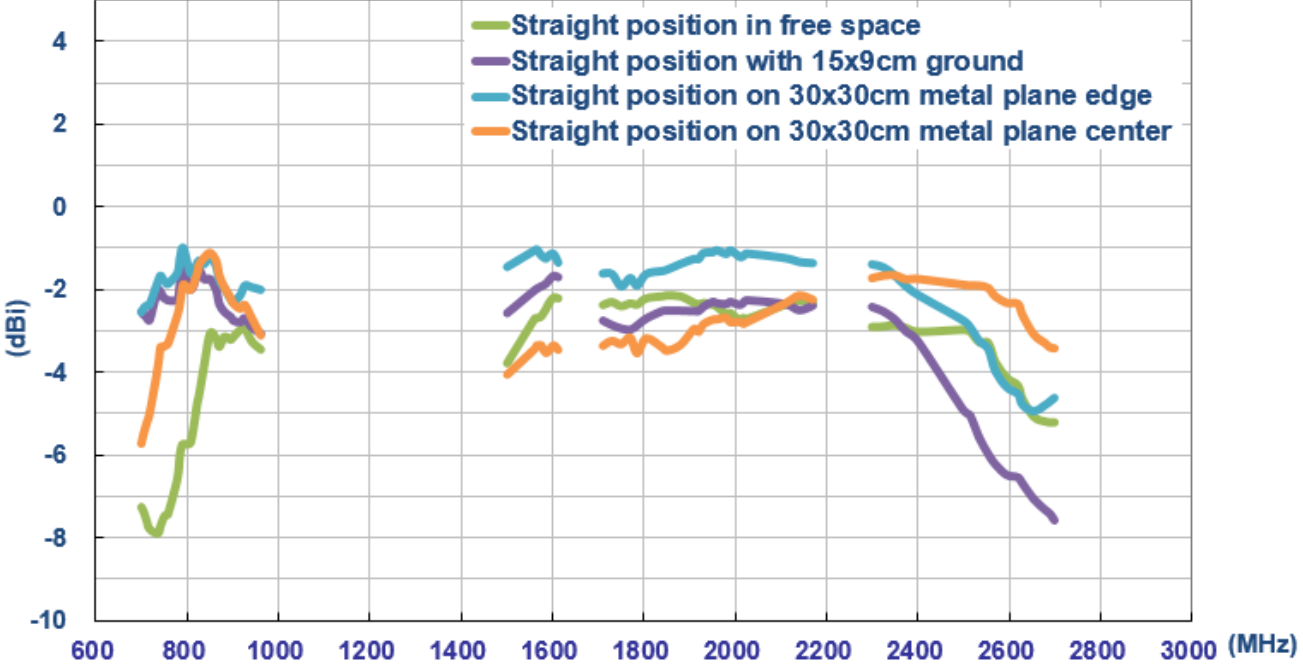

Figure 6. Peak gain of TG.08 antenna in straight position

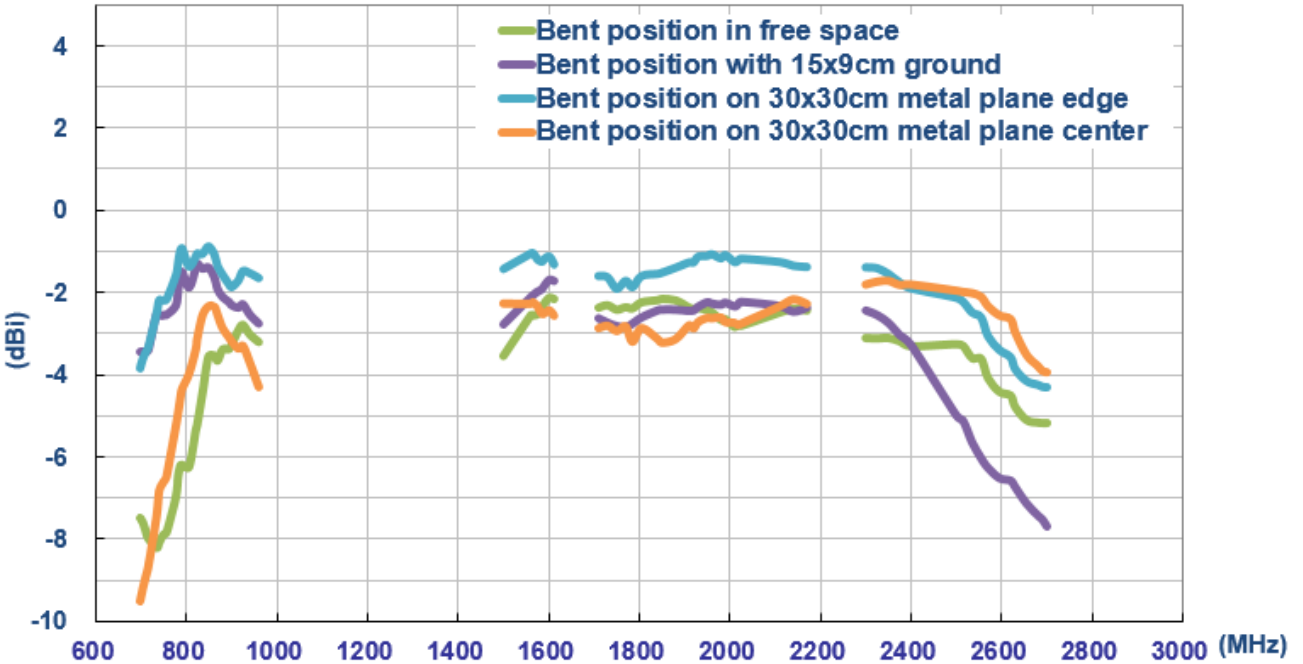

Figure 7. Peak gain of TG.08 antenna in bent position

● Average Gain

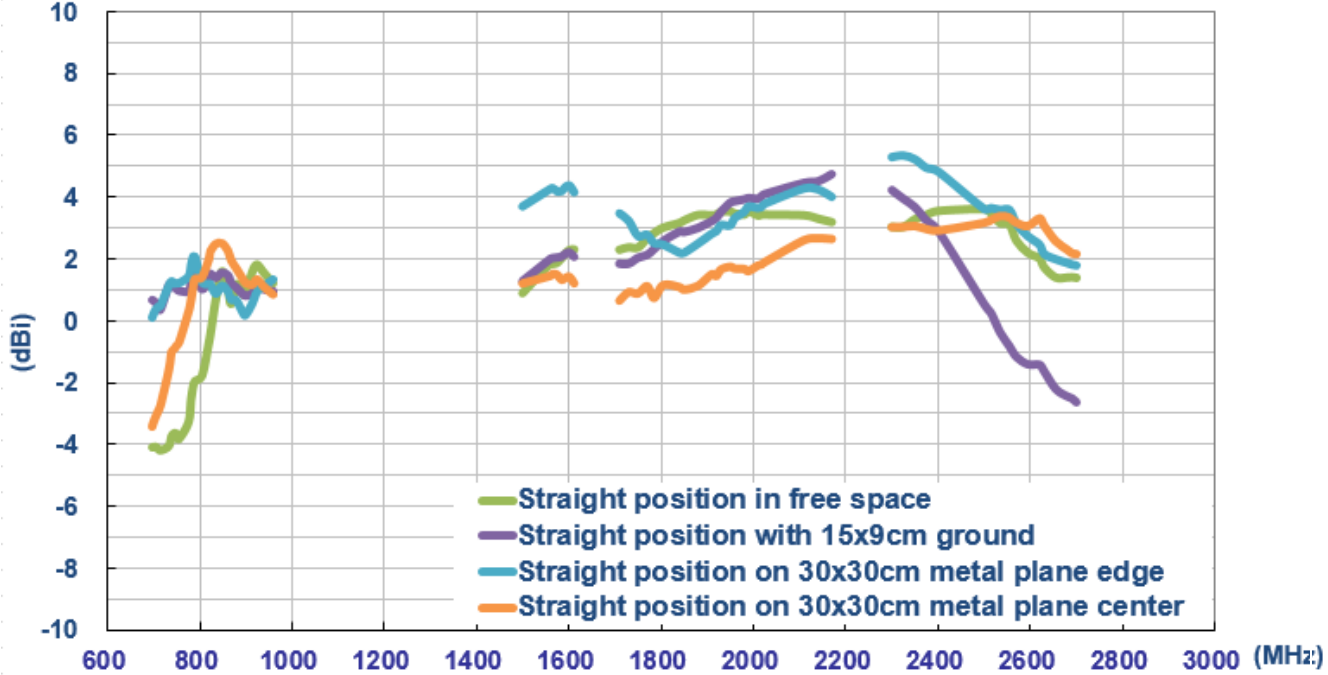

Figure 8. Average gain of TG.08 in straight position

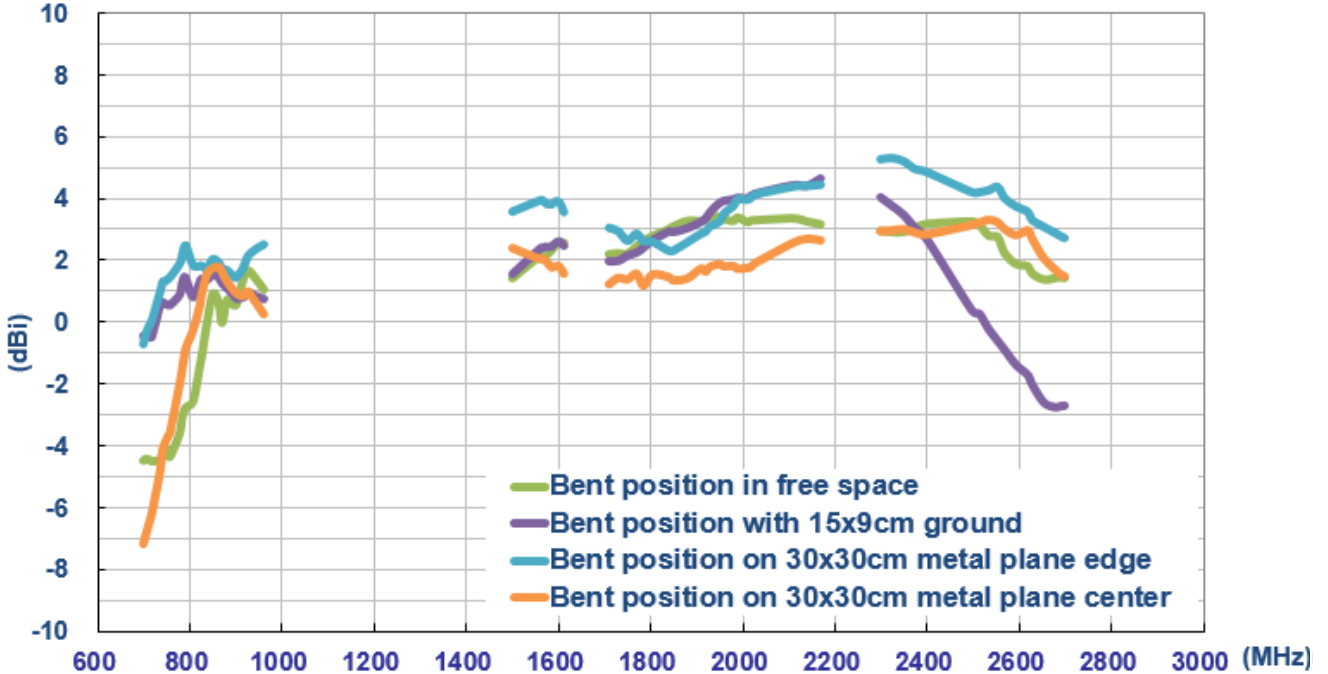
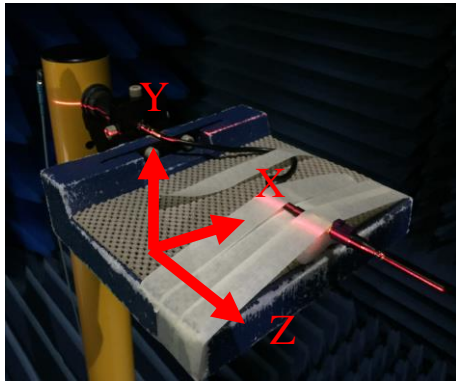

Figure 9. Average gain of TG.08 antenna in bent position

2. Antenna Radiation Patterns

The antenna radiation patterns were measured in a CTIA certified ETS Anechoic Chamber. The measurement setups are shown below.

Antenna with Straight Position



In free space

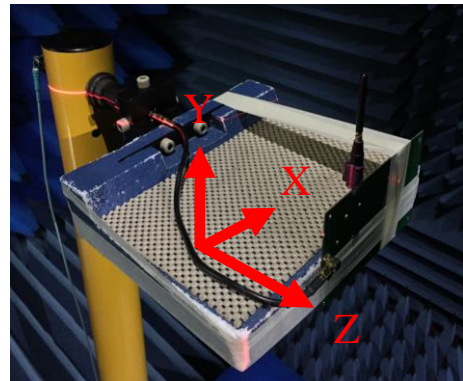

With 15x9cm ground plane

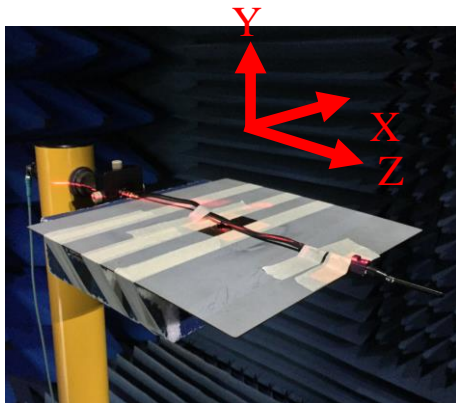

On 30x30cm metal ground edge

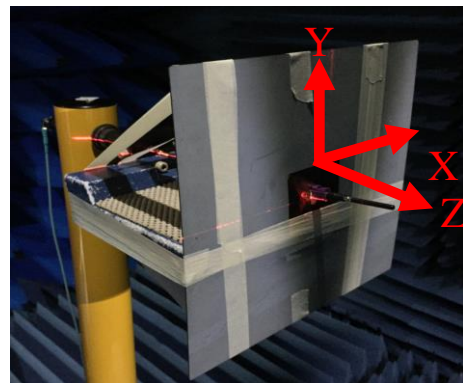

On 30x30cm metal ground center

Antenna Bent Position

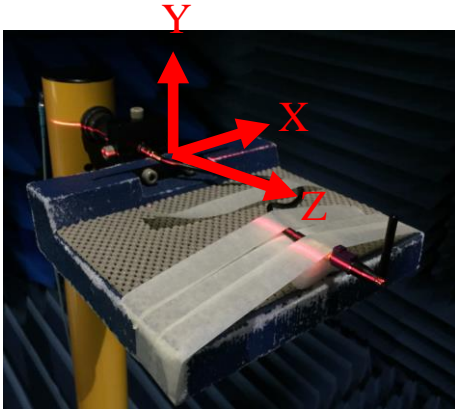

In free space

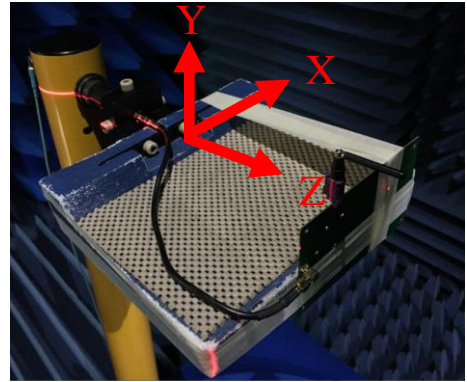

With 15x9cm ground plane

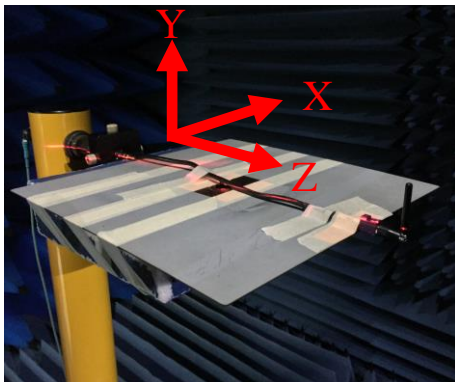

On 30x30cm metal ground edge

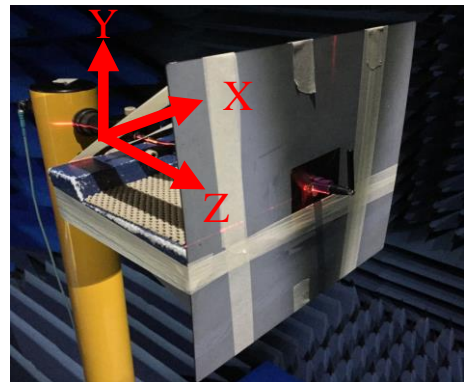

On 30x30cm metal ground center

Figure 10. Testing Setup in ETS Anechoic Chamber

**2D Radiation Pattern
(Straight Position in Free Space)**

XY Plane

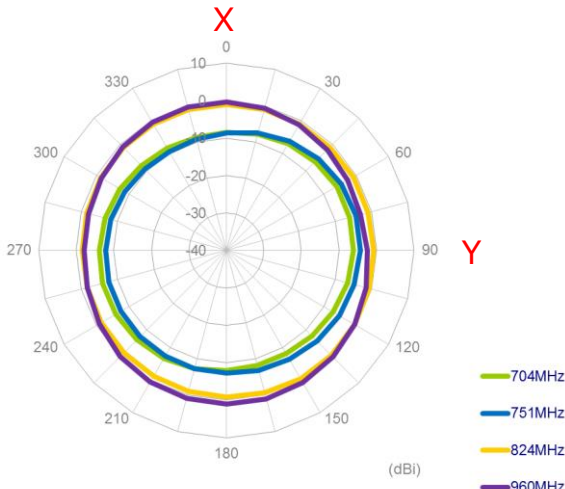

XY Plane

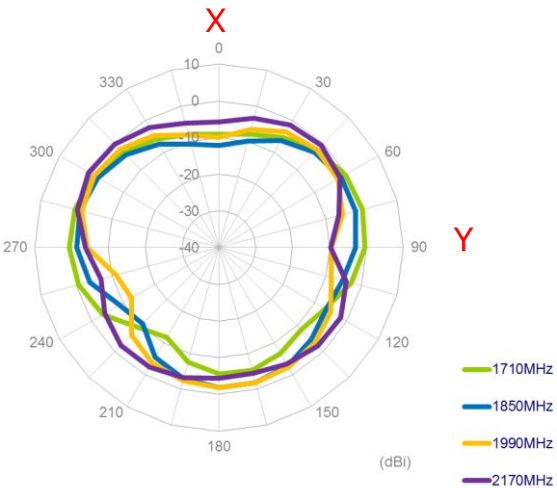

XY Plane

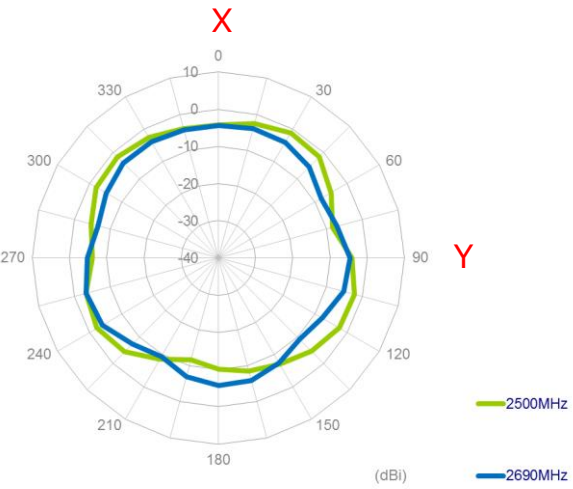

XY Plane

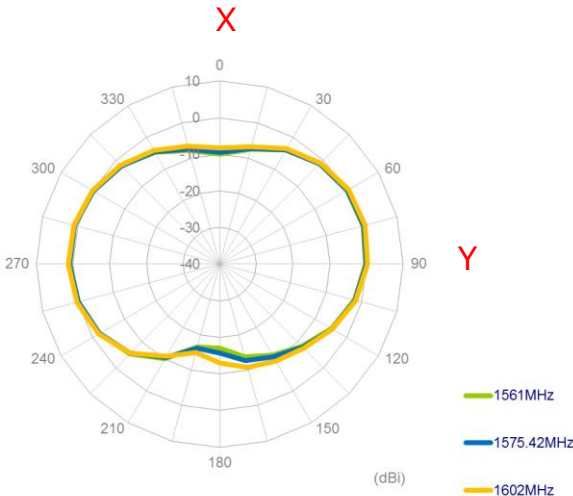

XZ Plane

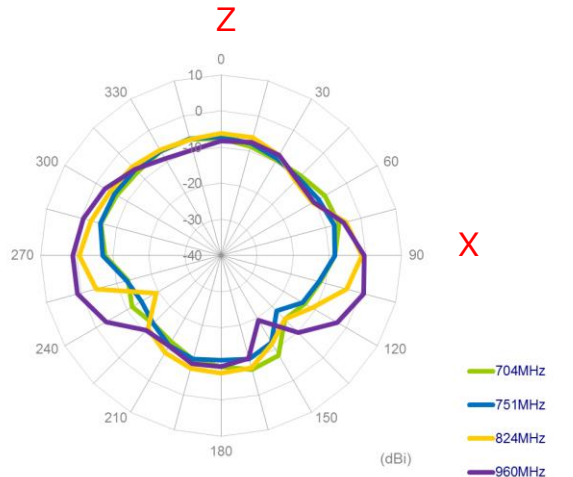

XZ Plane

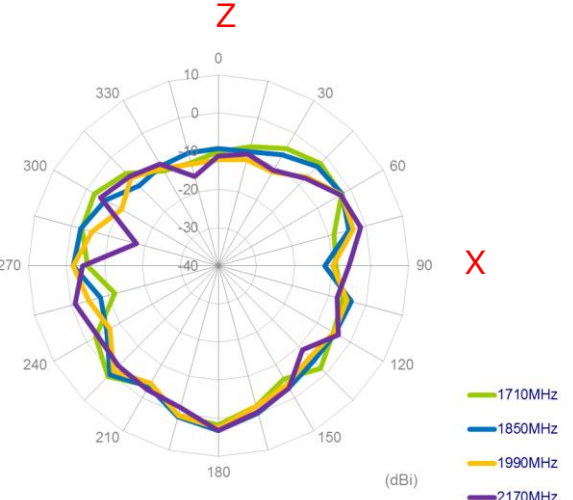

XZ Plane

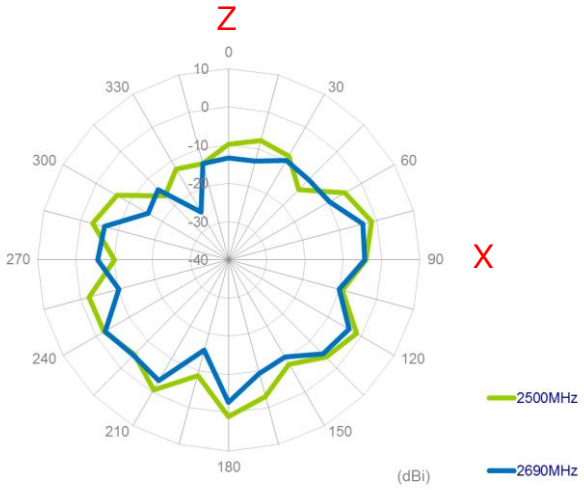

XZ Plane

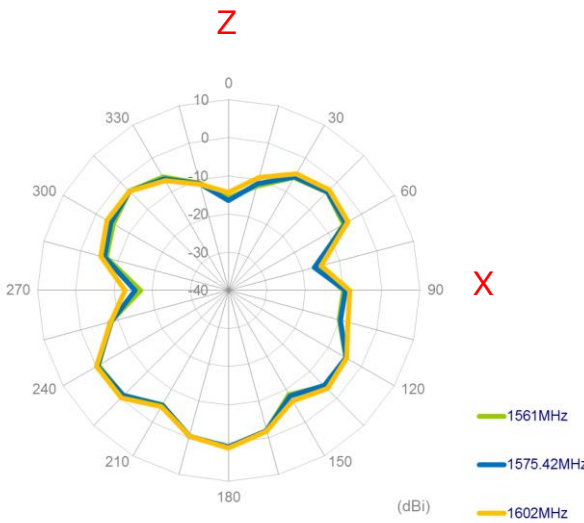

YZ Plane

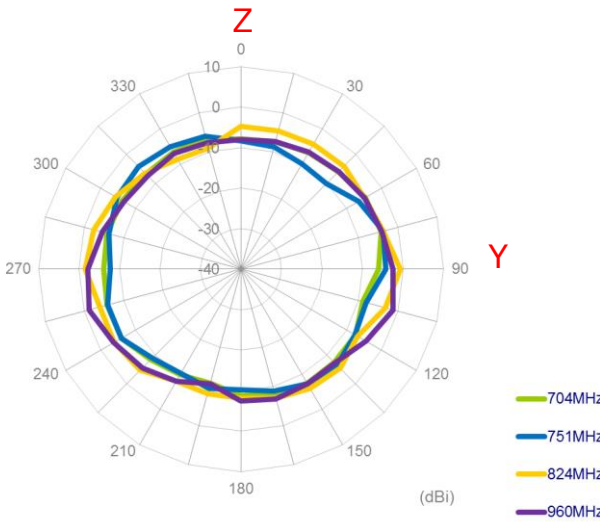

YZ Plane

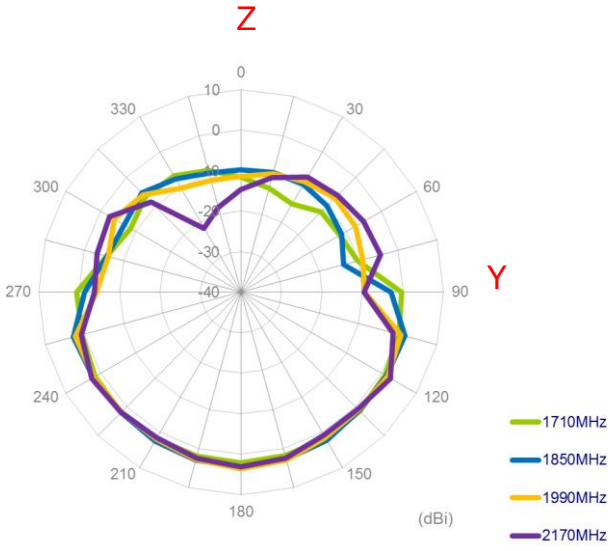

YZ Plane

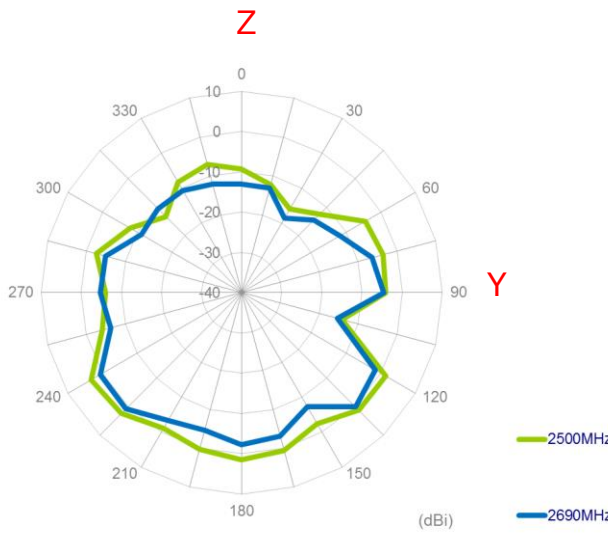

YZ Plane

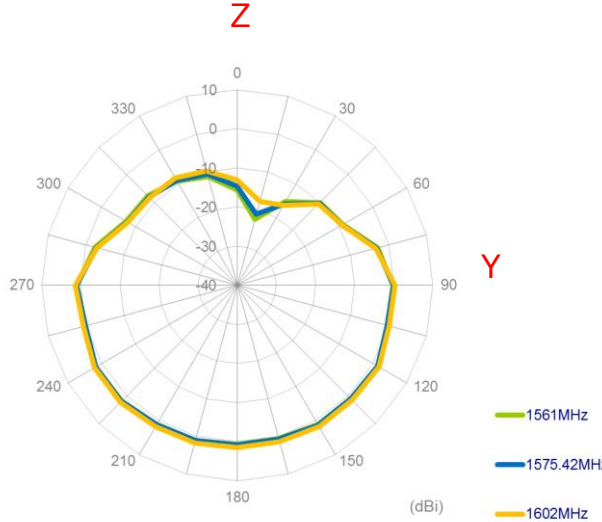

**2D Radiation Pattern
(Straight Position with 15x9cm Ground)**

XY Plane

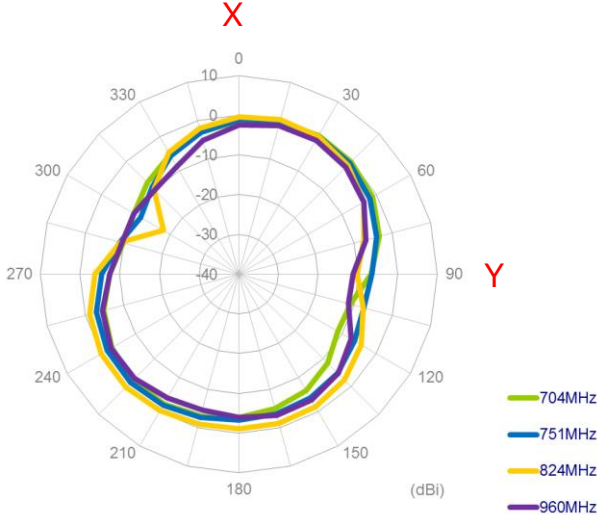

XY Plane

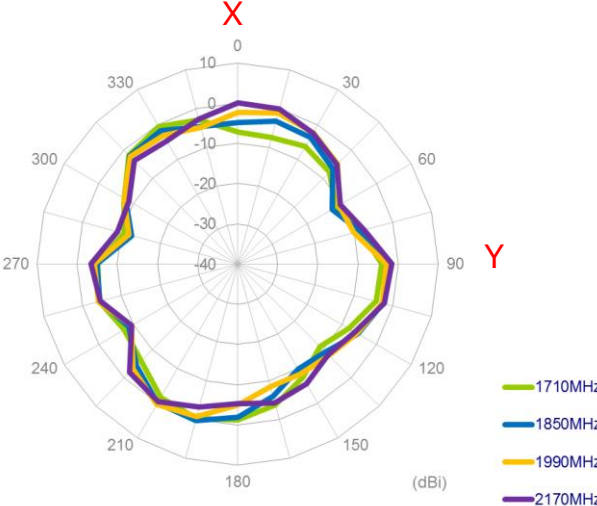

XY Plane

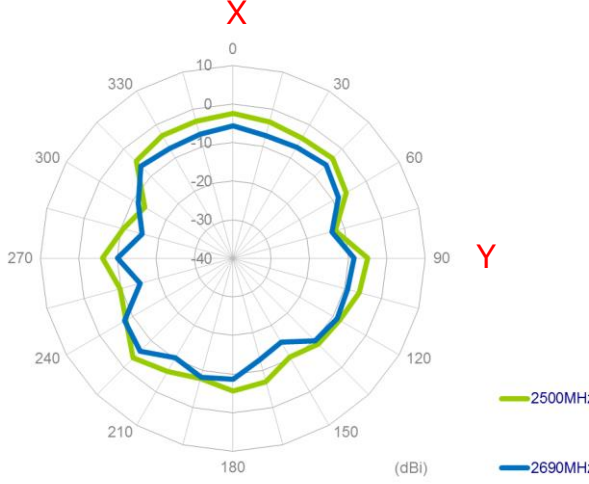

XY Plane

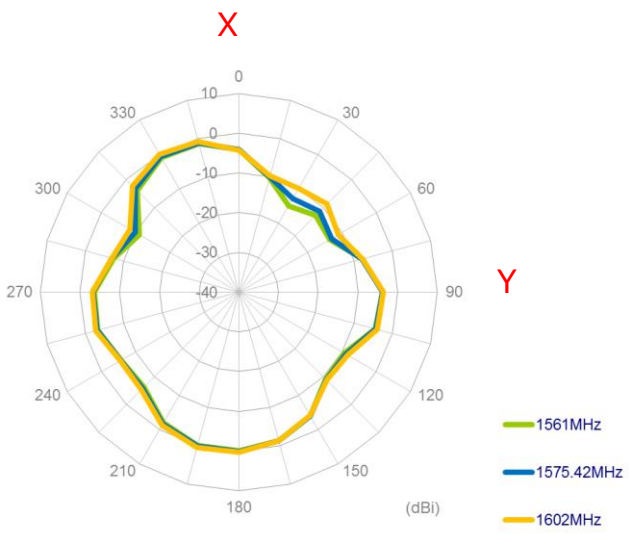

XZ Plane

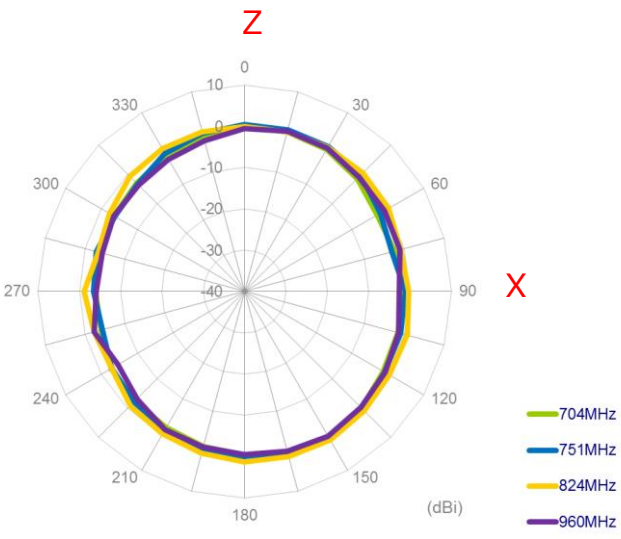

XZ Plane

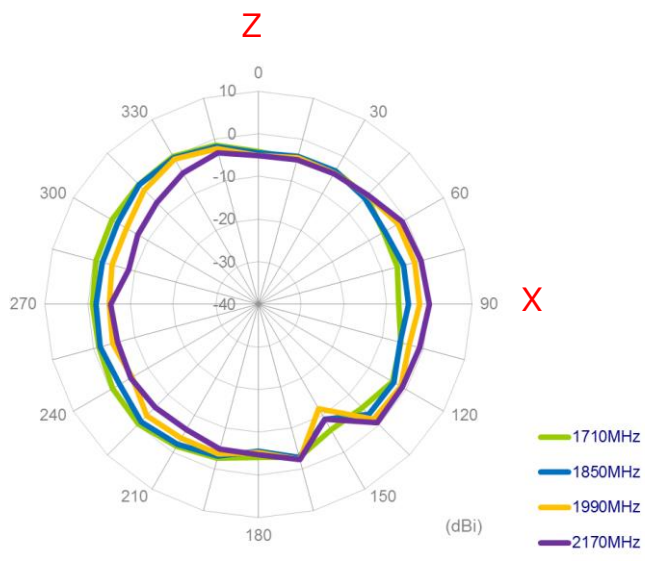

XZ Plane

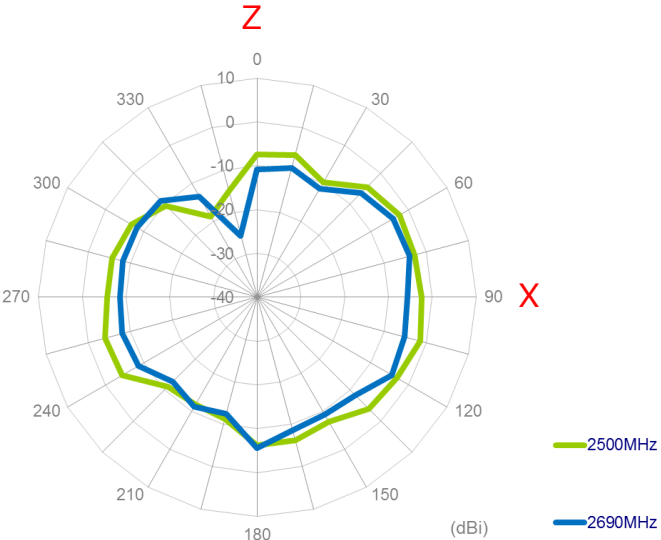

XZ Plane

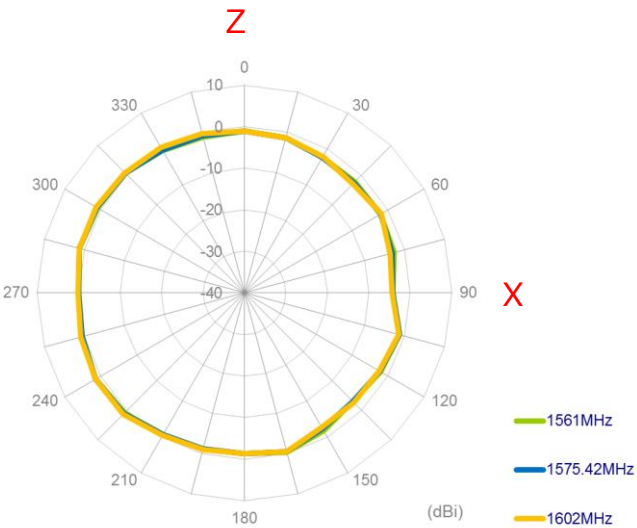

YZ Plane

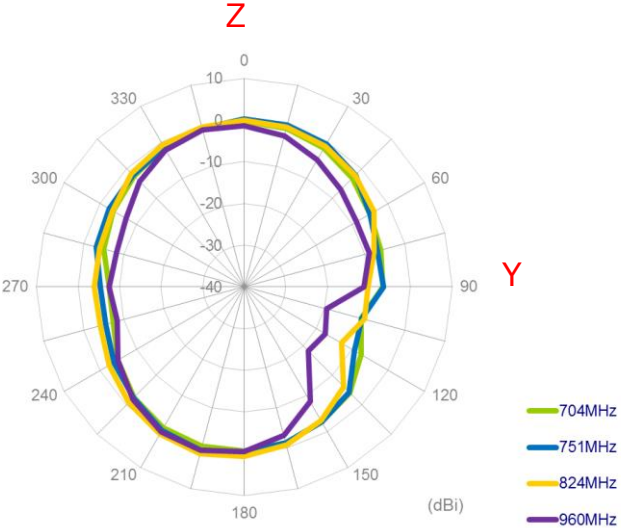

YZ Plane

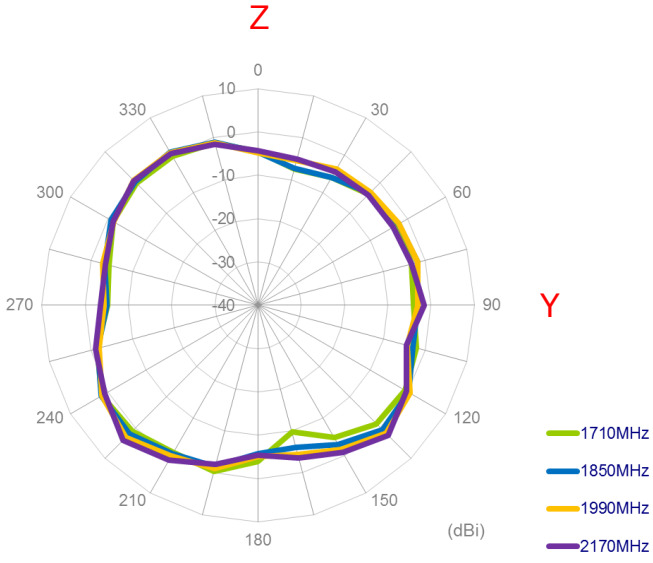

YZ Plane

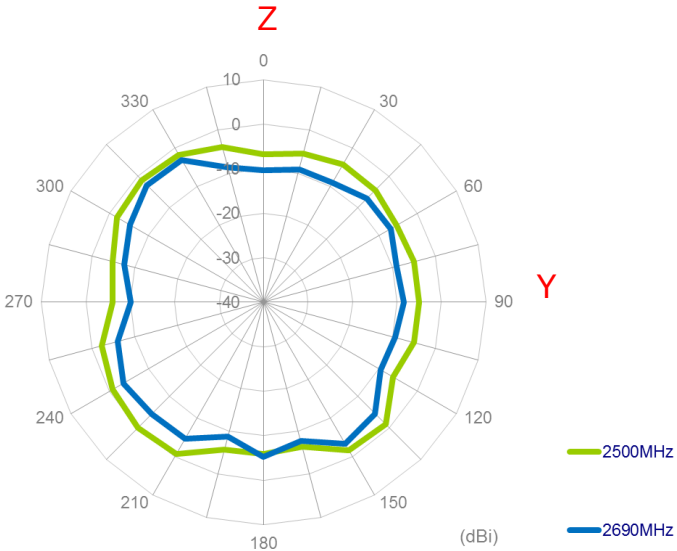

YZ Plane

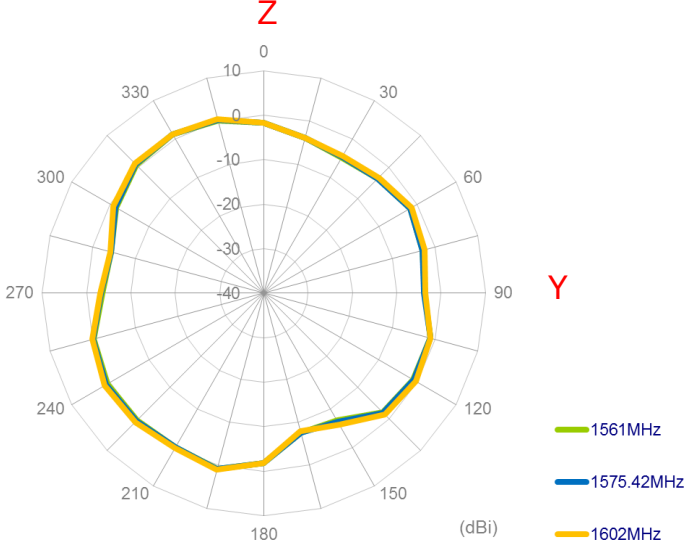

**2D Radiation Pattern
(Straight Position with 30x30cm Metal Ground Edge)**

XY Plane

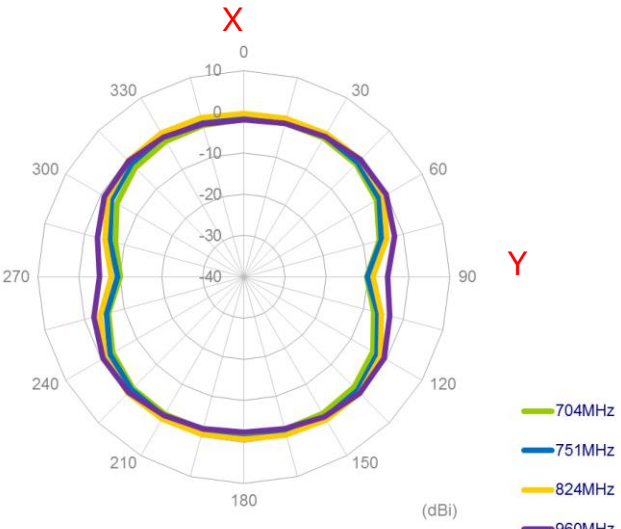

XY Plane

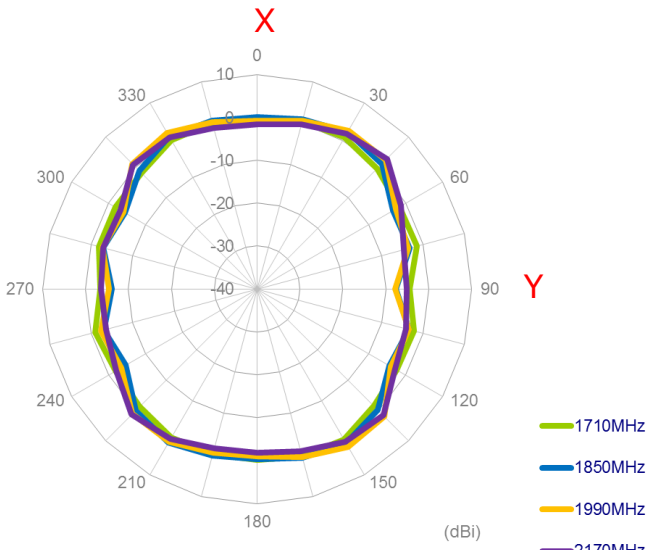

XY Plane

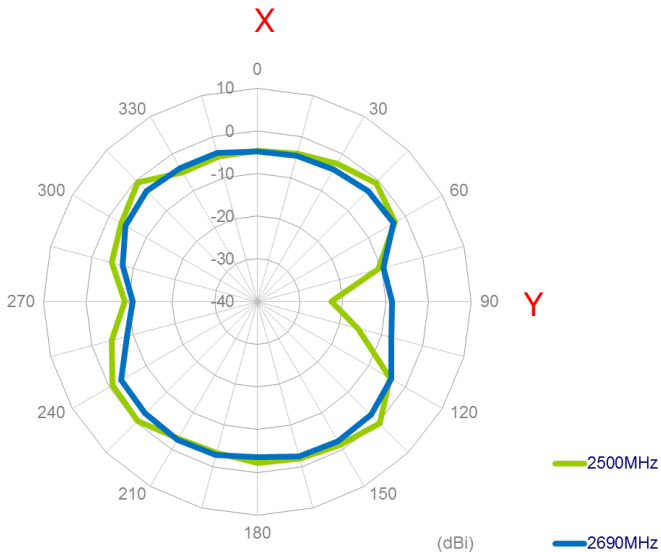

XY Plane

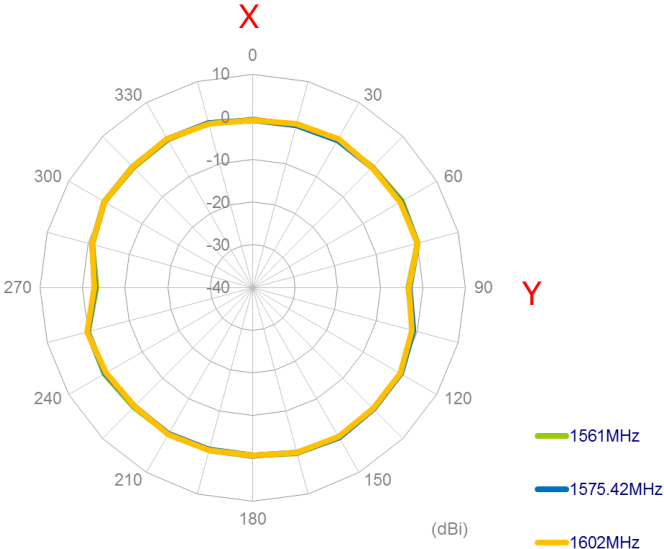

XZ Plane

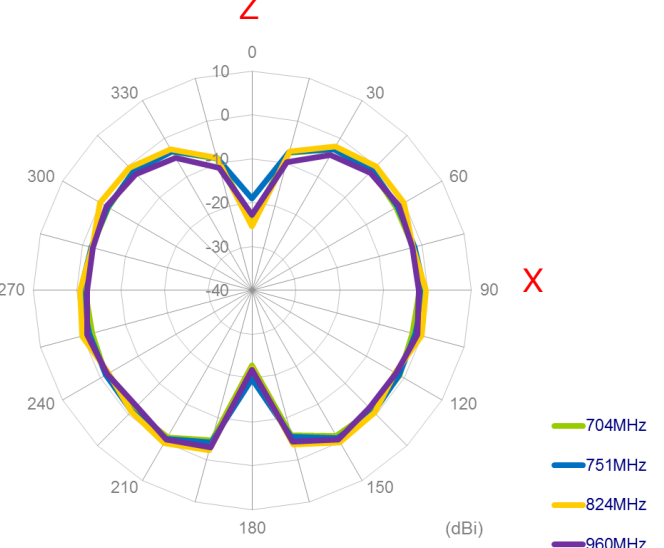

XZ Plane

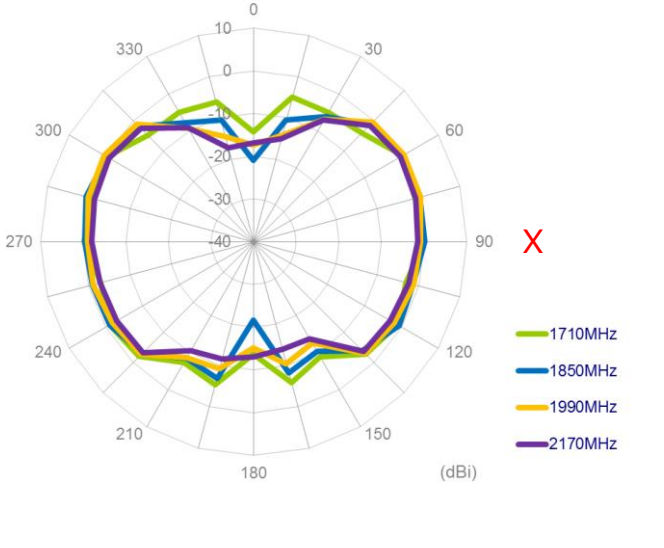

XZ Plane

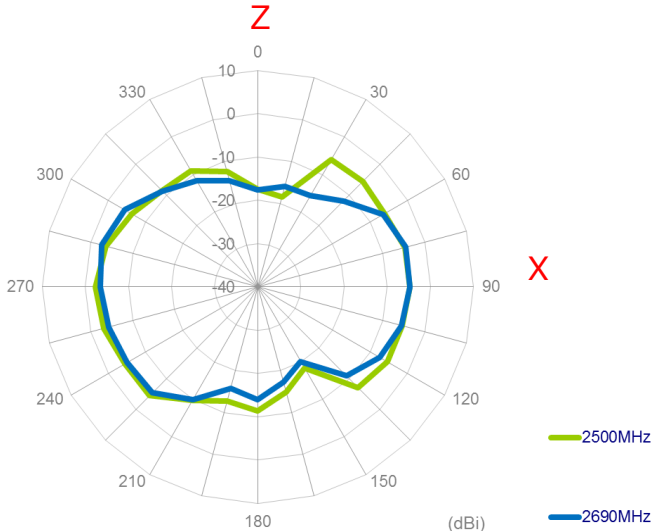

XZ Plane

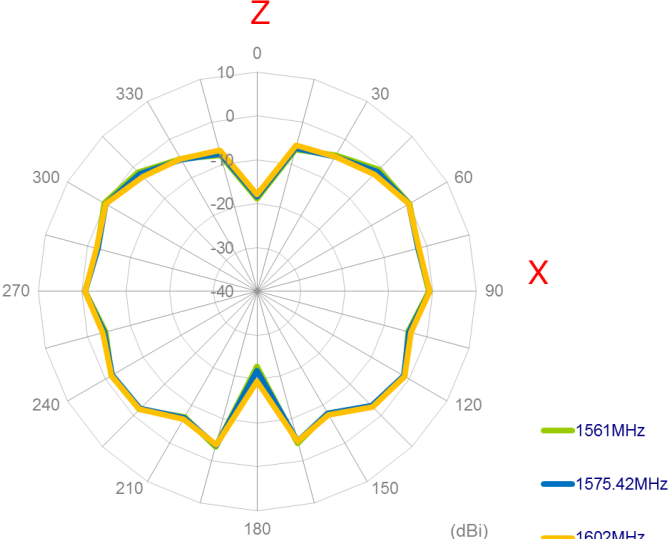

YZ Plane

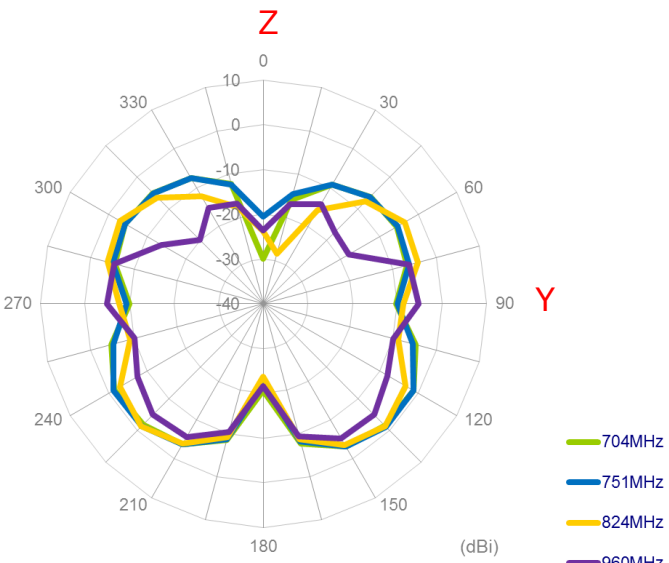

YZ Plane

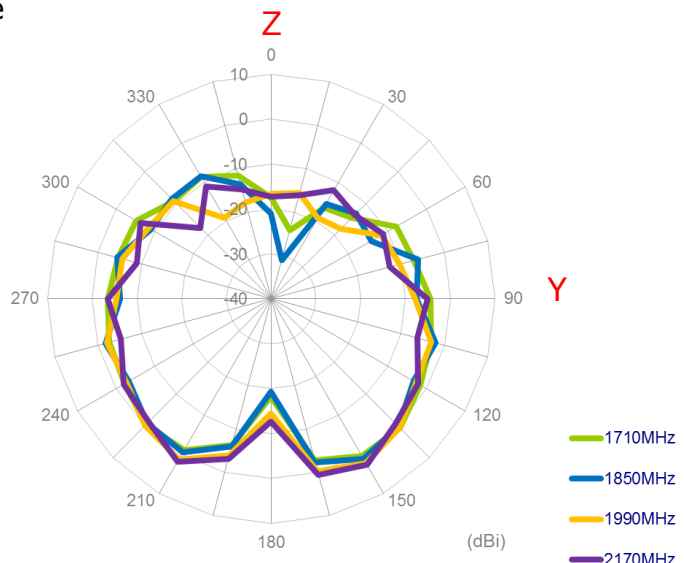

YZ Plane

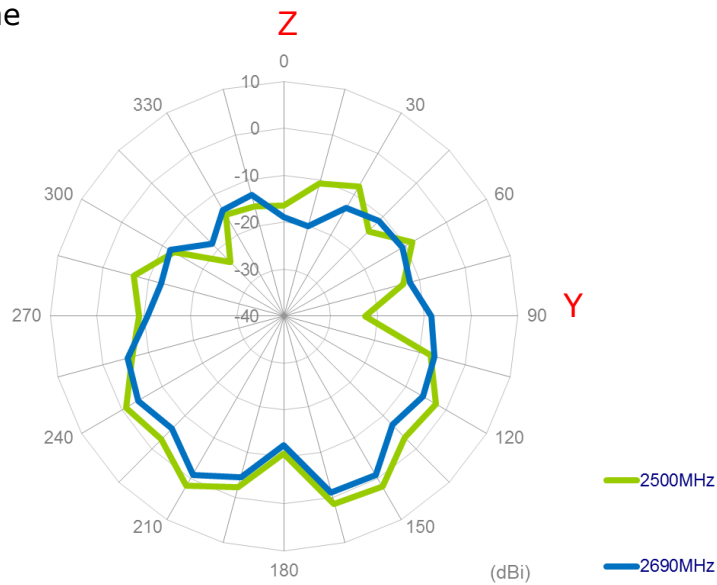

YZ Plane

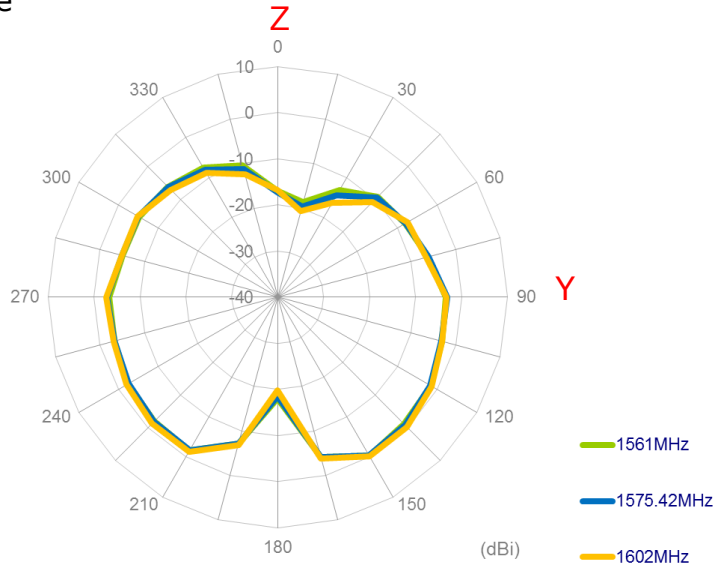

**2D Radiation Pattern
(Straight Position with 30x30cm Metal Ground Center)**

X

XY Plane

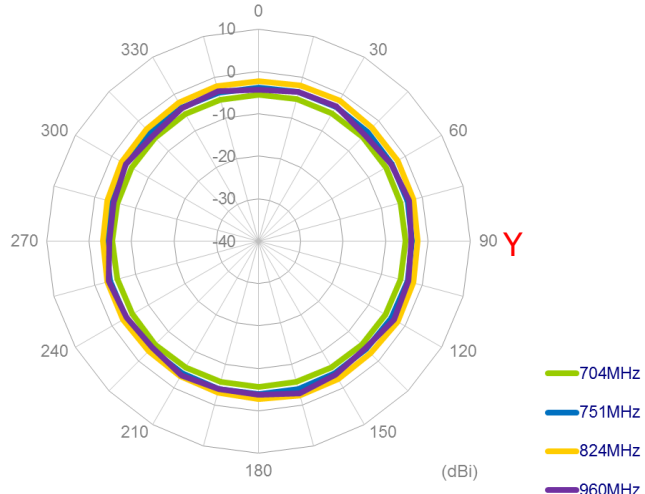

XY Plane

X

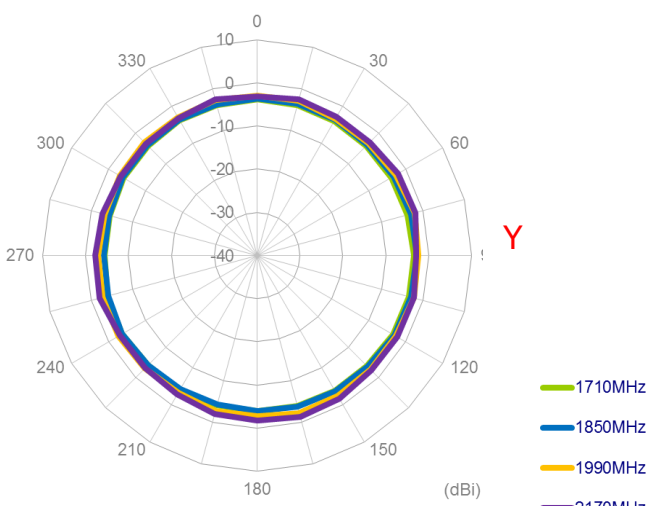

XY Plane

X

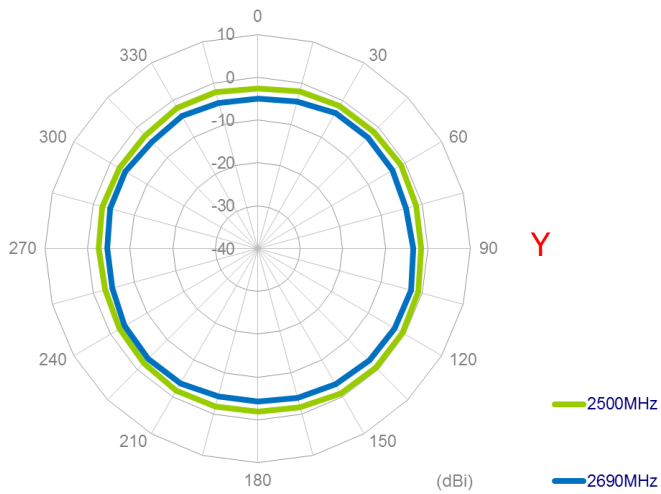

XY Plane

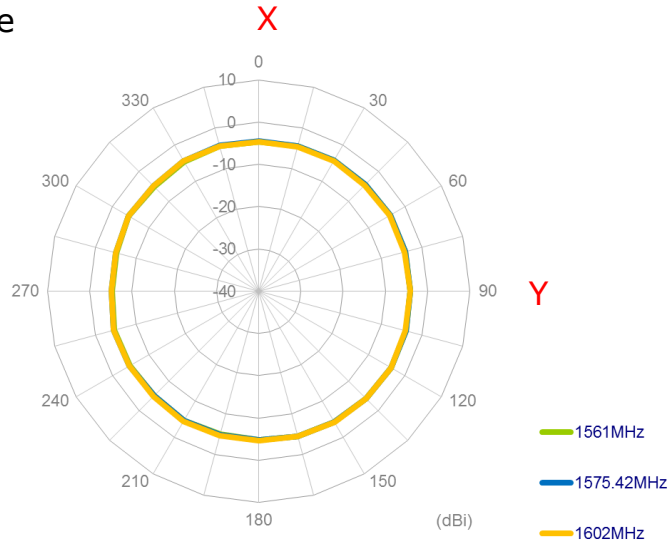

XZ Plane

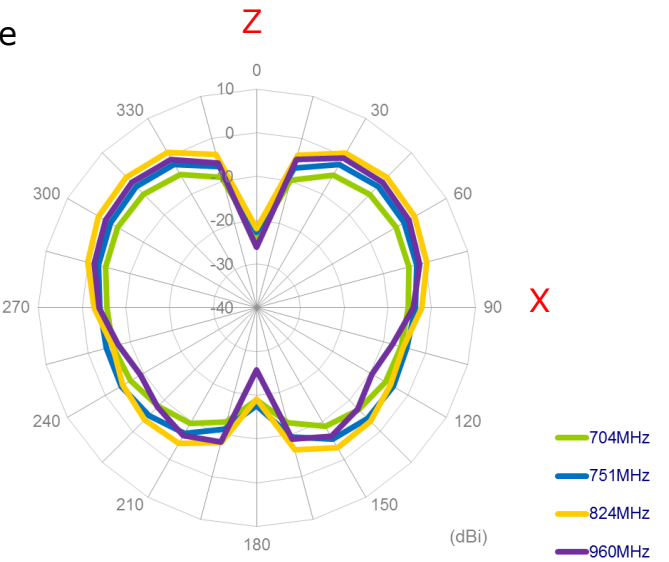

XZ Plane

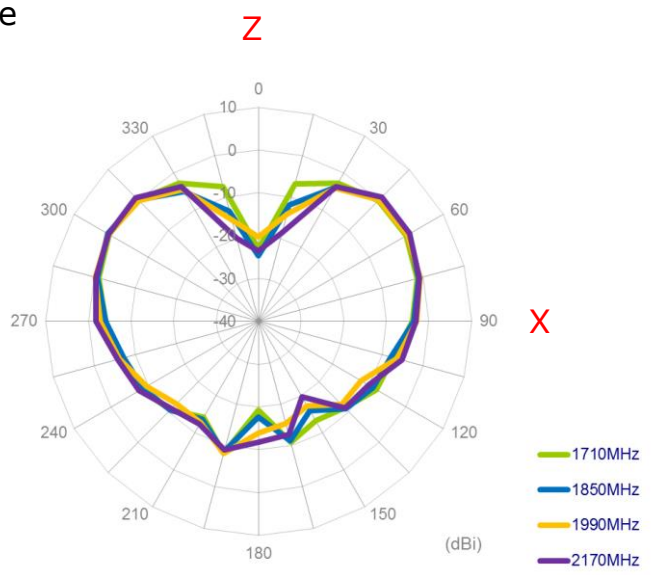

XZ Plane

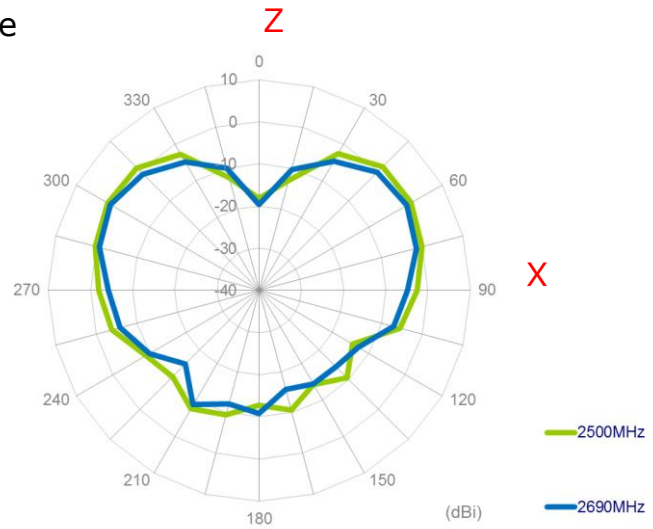

XZ Plane

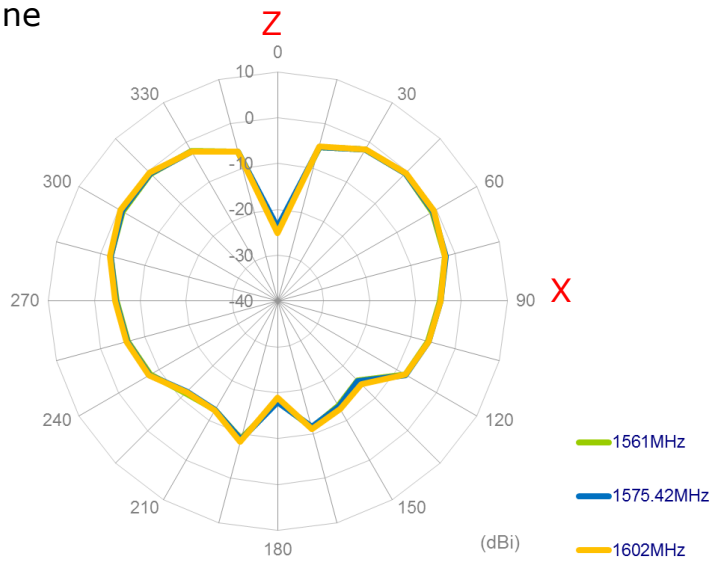

YZ Plane

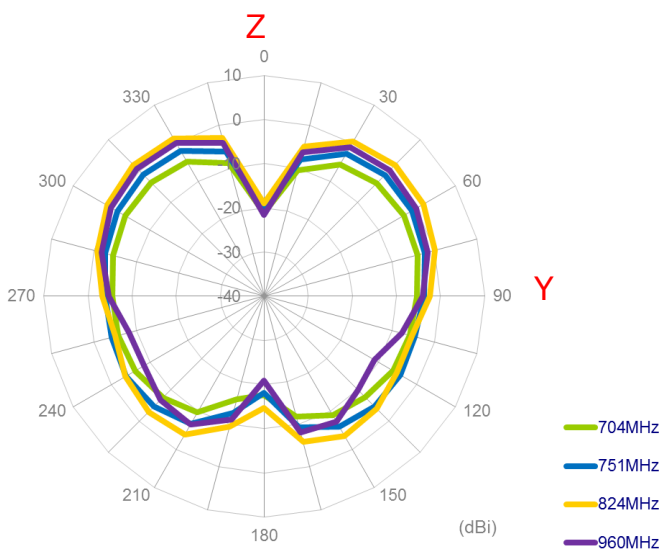

YZ Plane

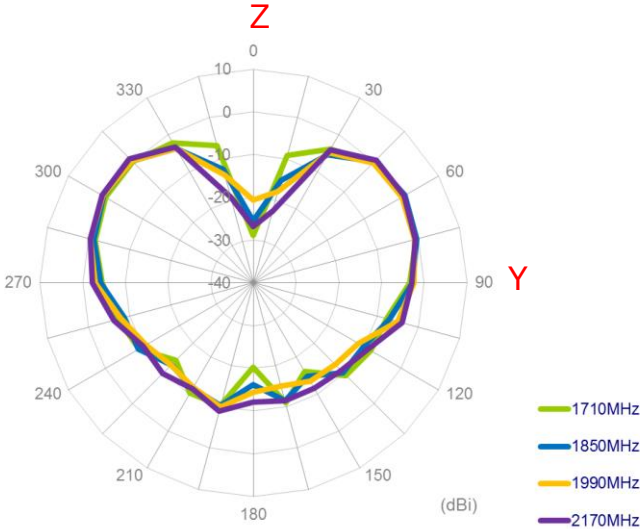

YZ Plane

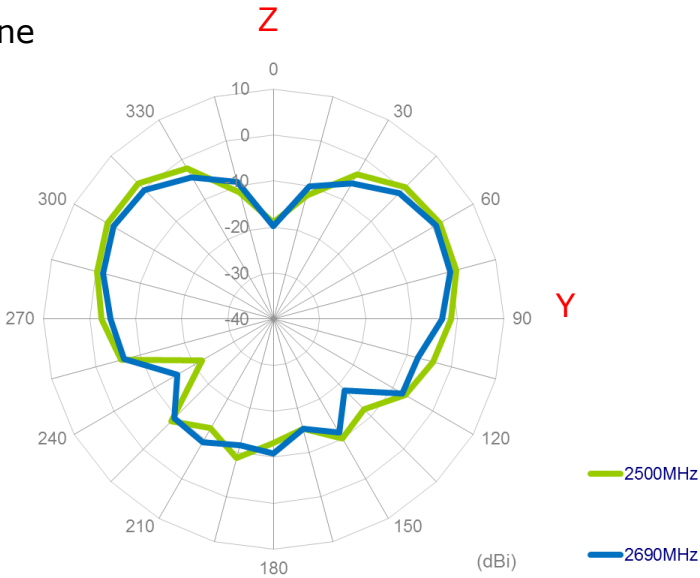

YZ Plane

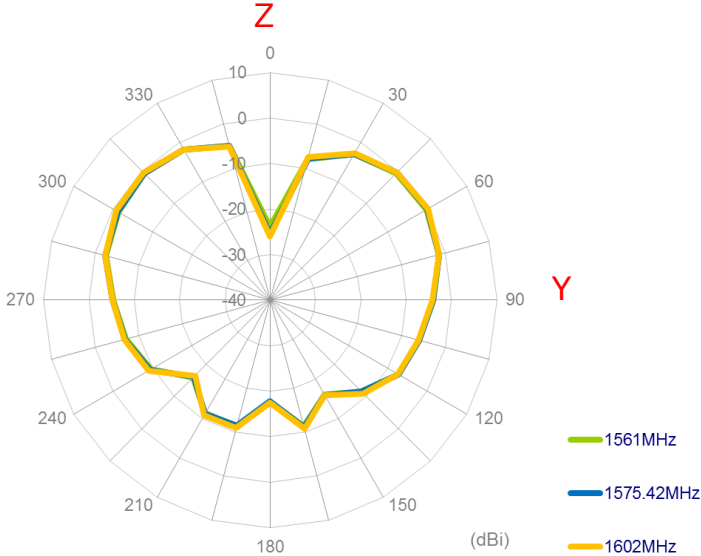

**2D Radiation Pattern
(Bent Position in Free Space)**

XY Plane

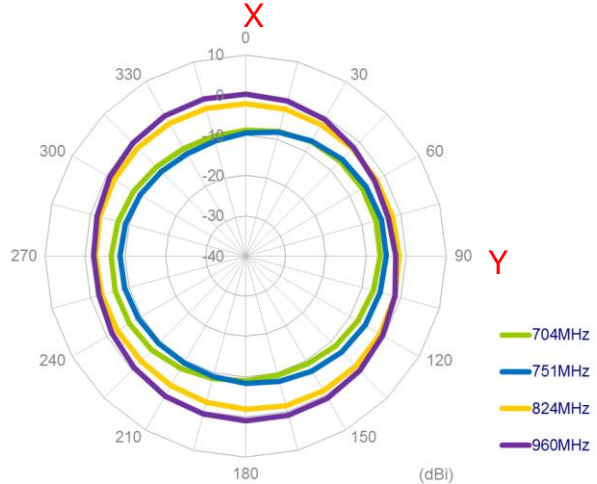

XY Plane

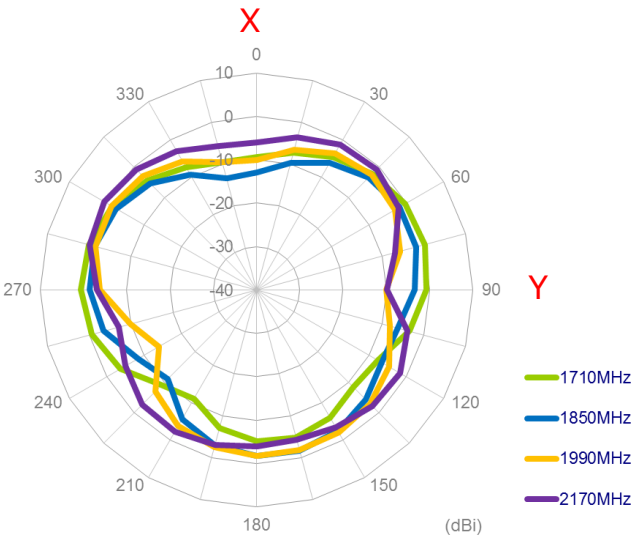

XY Plane

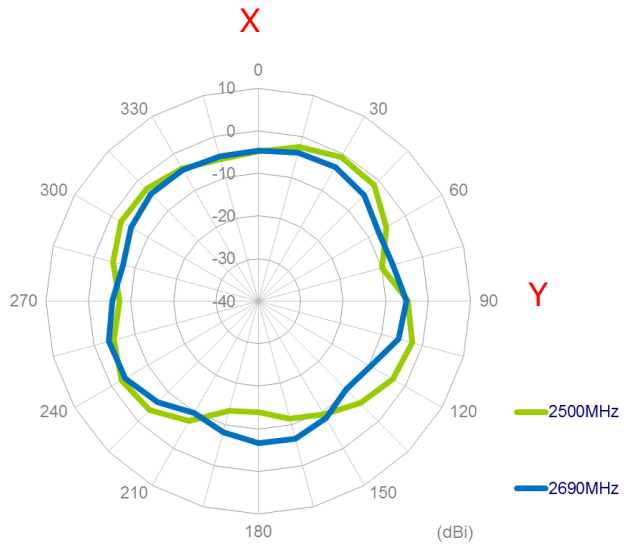

XY Plane

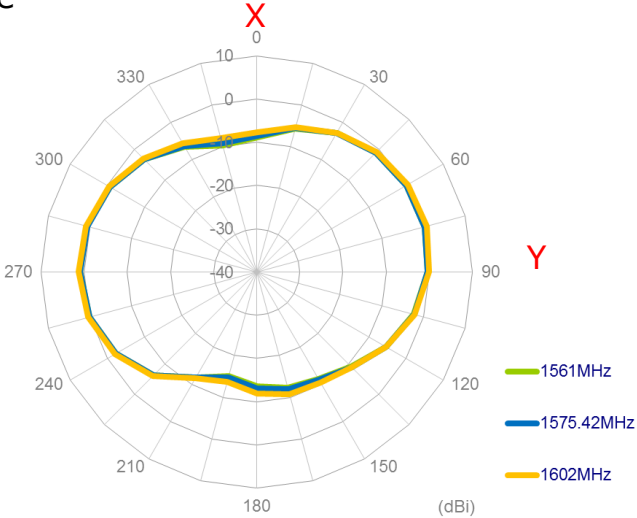

XZ Plane

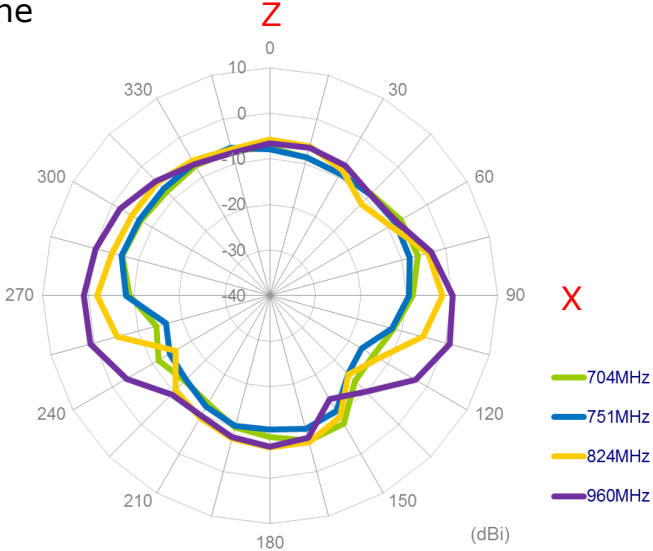

XZ Plane

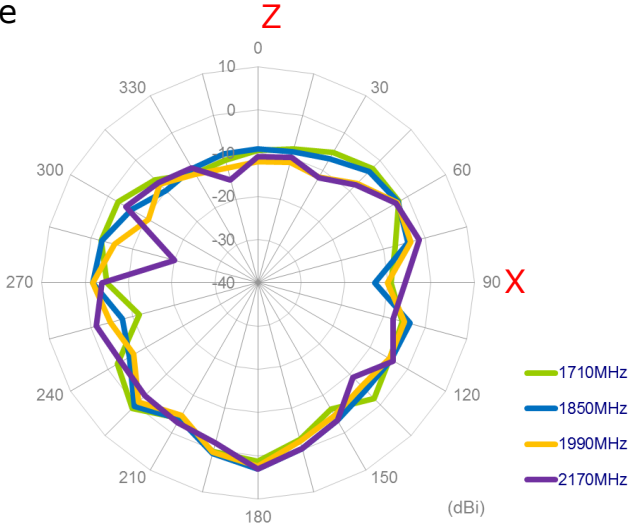

XZ Plane

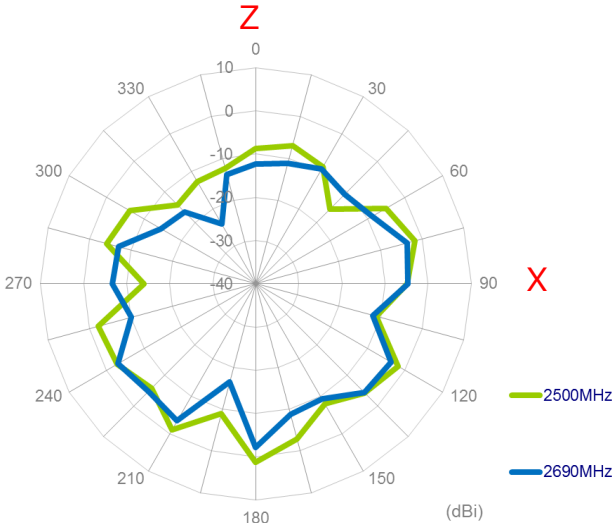

XZ Plane

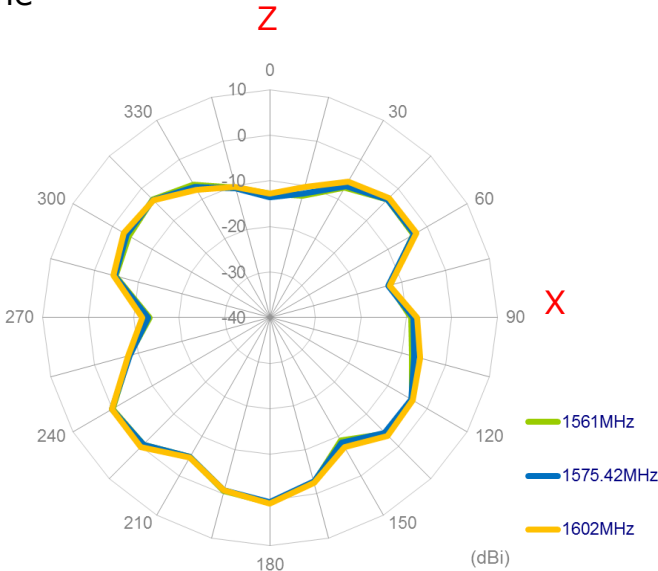

YZ Plane

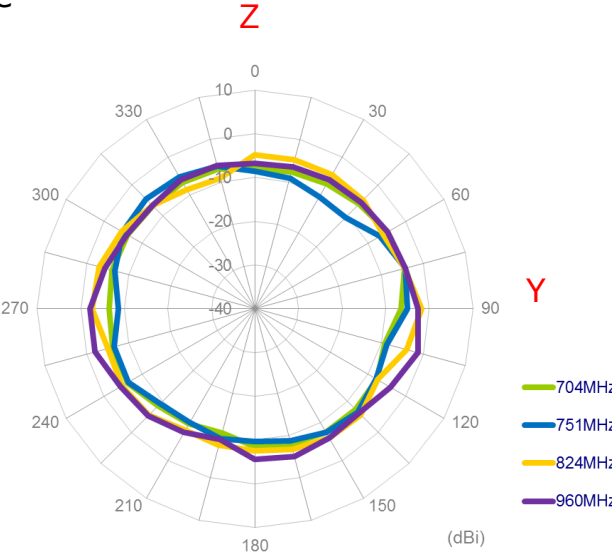

YZ Plane

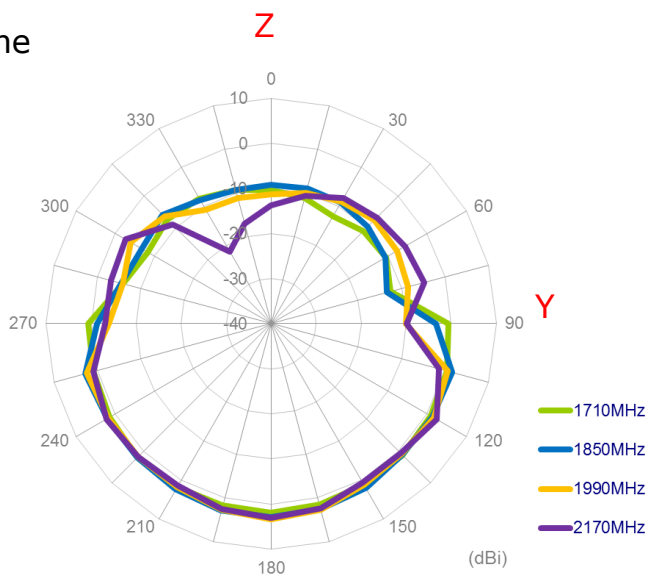

YZ Plane

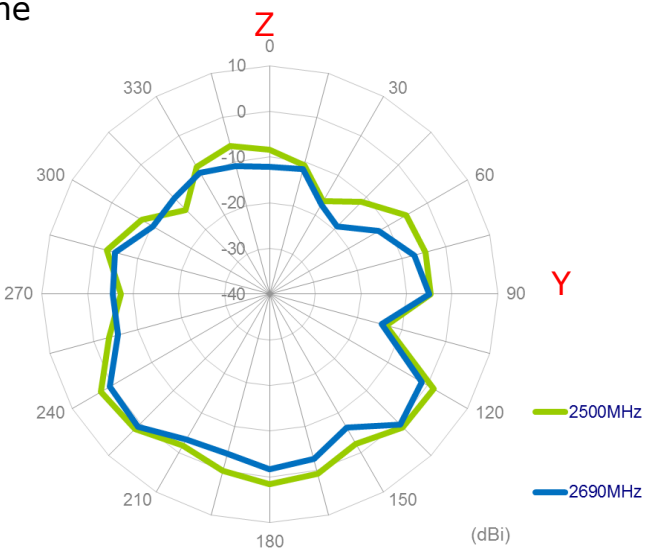

YZ Plane

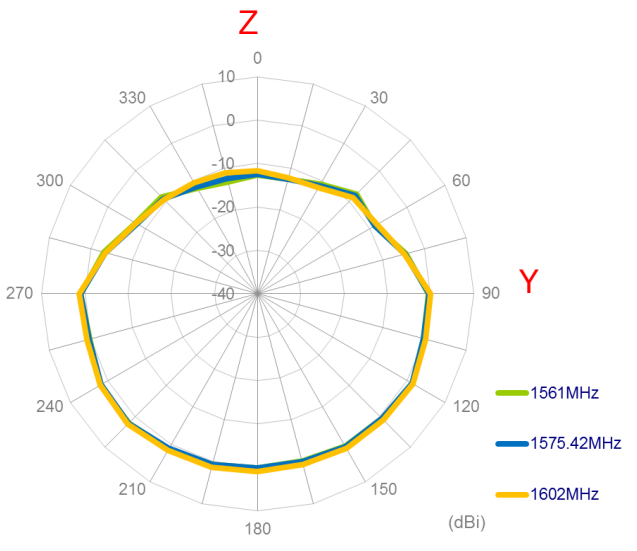

**2D Radiation Pattern
(Bent Position with 15x9cm Ground)**

XY Plane

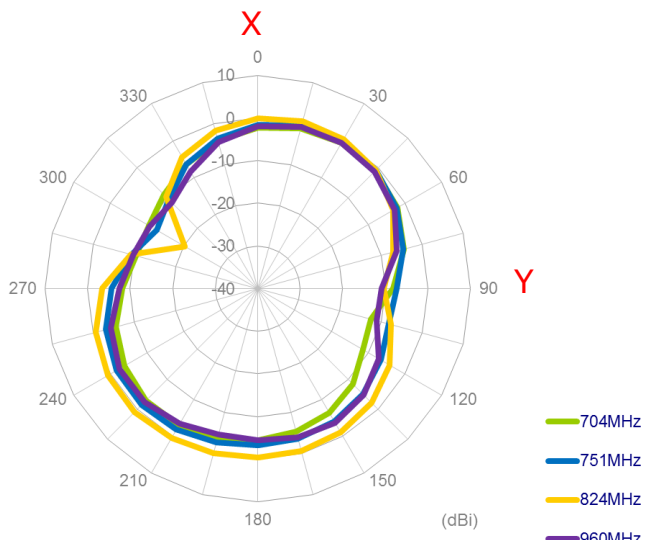

XY Plane

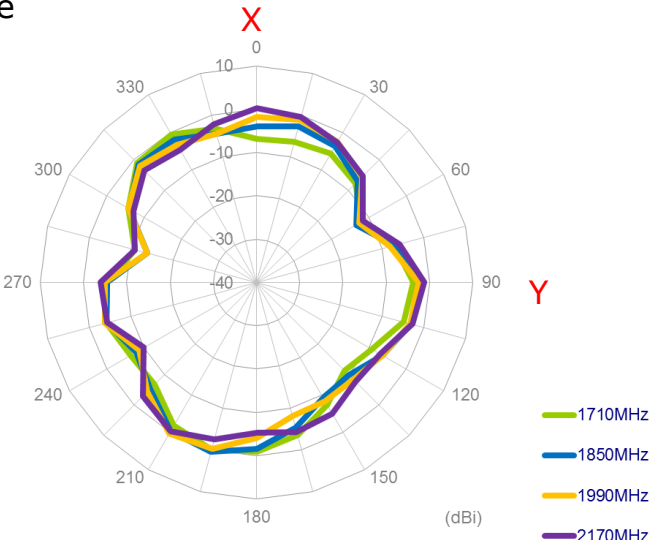

XY Plane

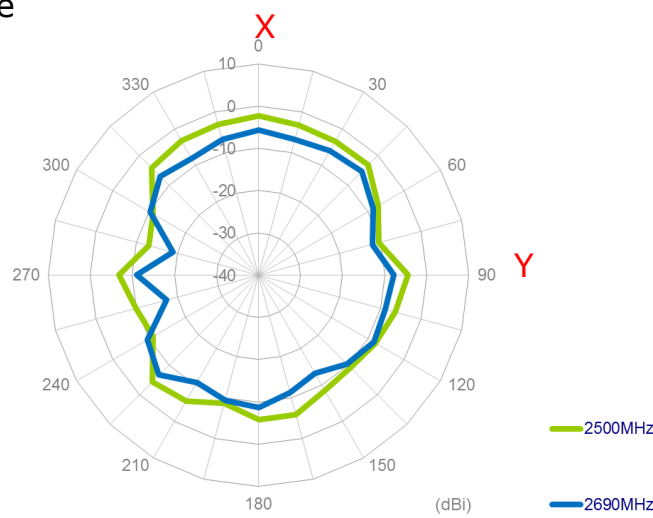

XY Plane

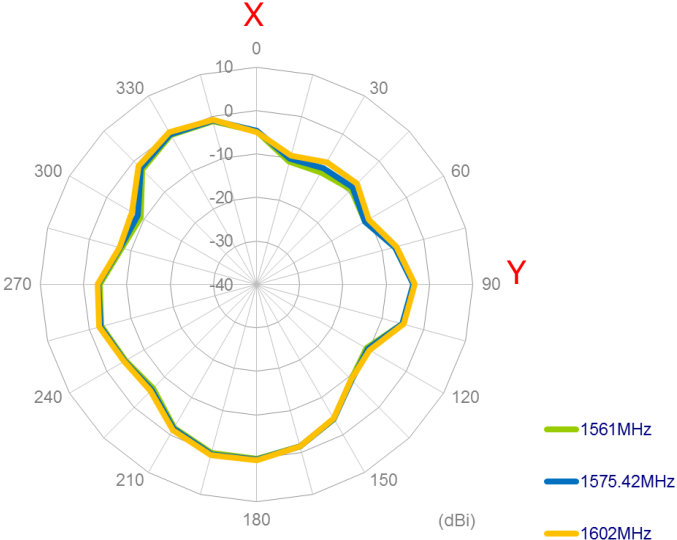

XZ Plane

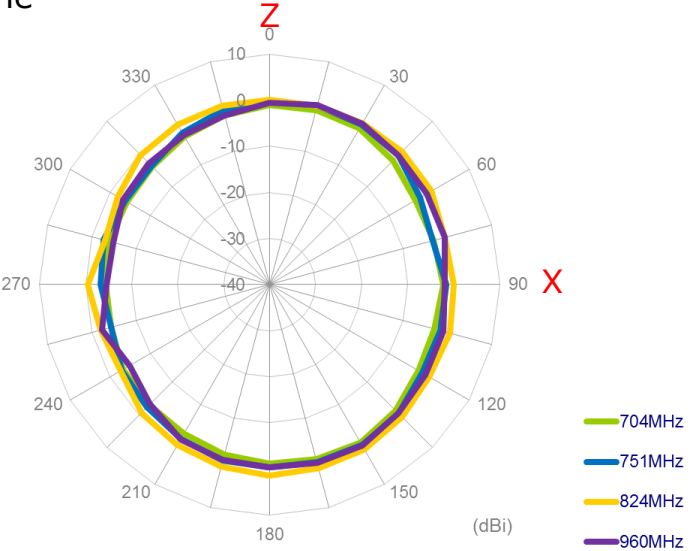

XZ Plane

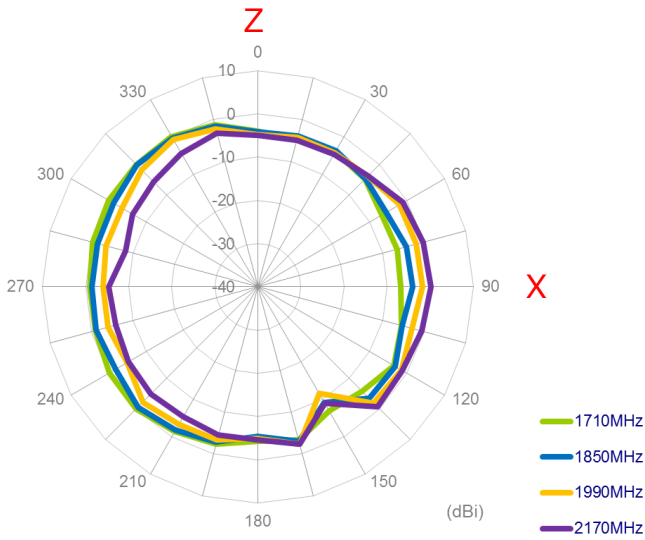

XZ Plane

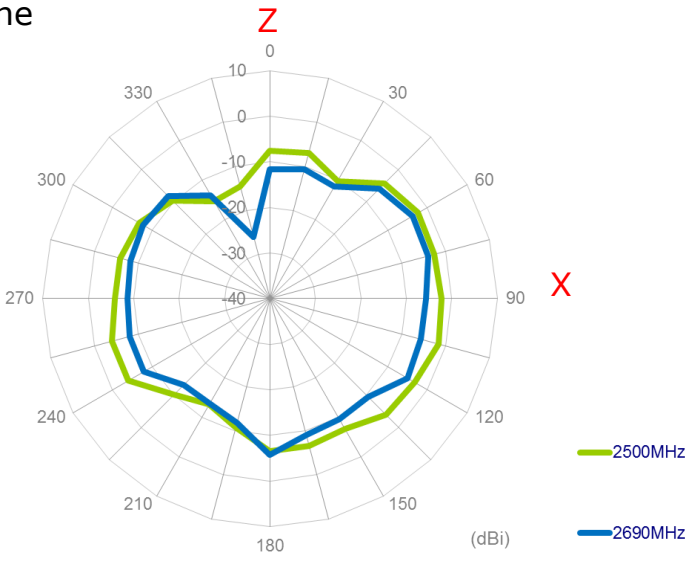

XZ Plane

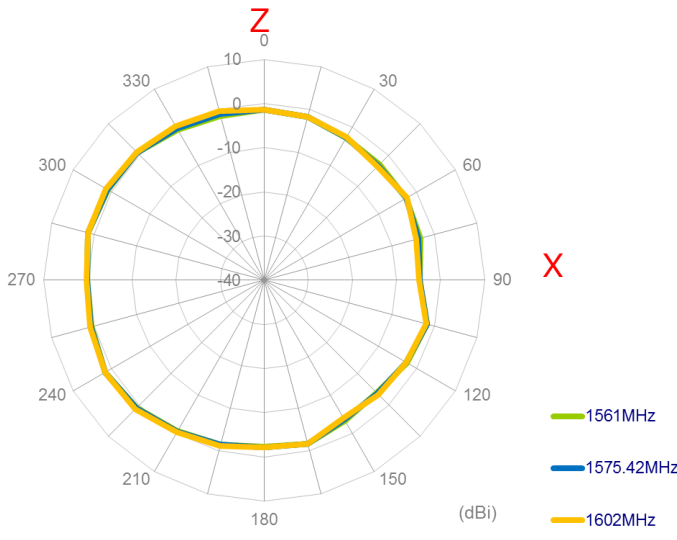

YZ Plane

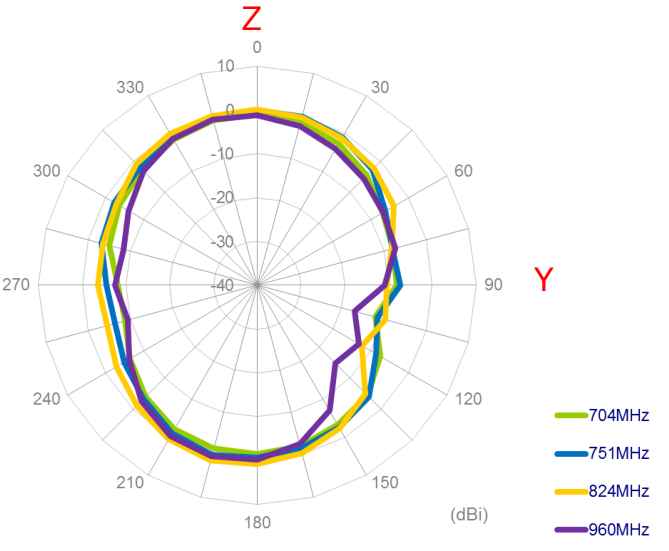

YZ Plane

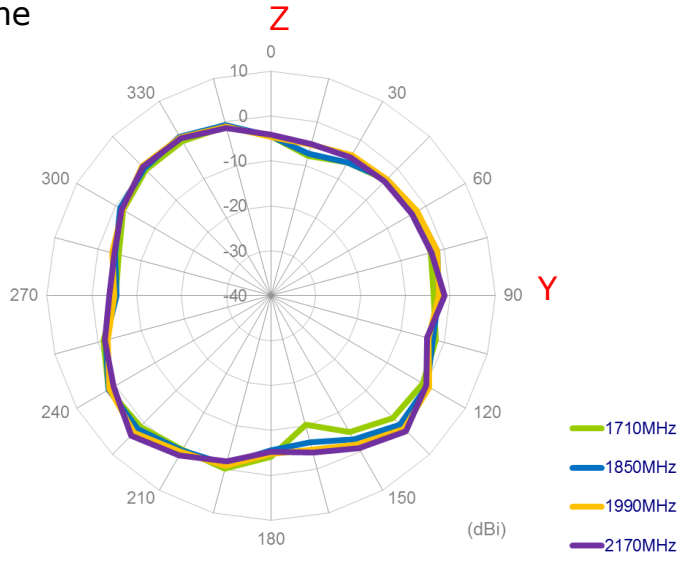

YZ Plane

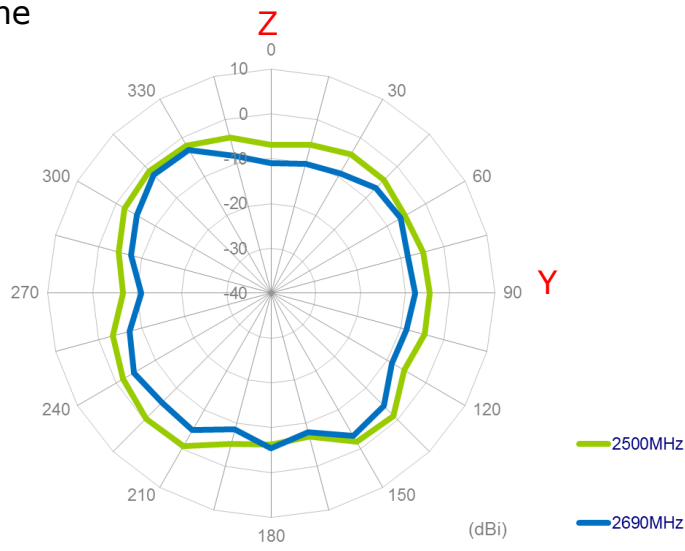

YZ Plane

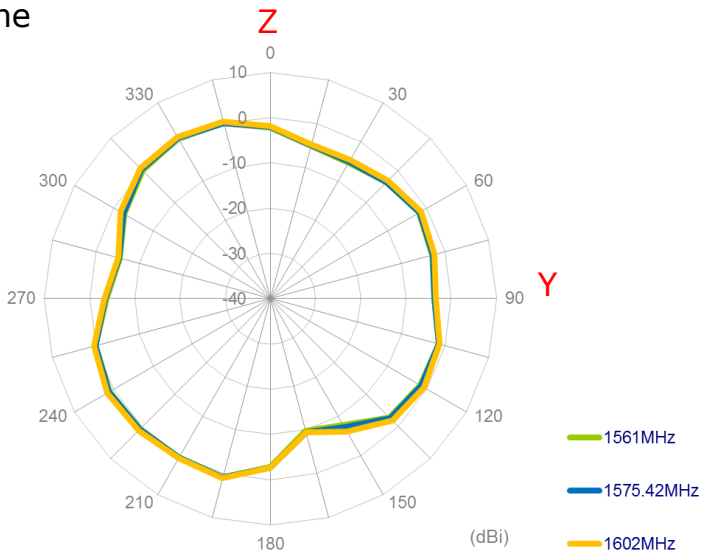

**2D Radiation Pattern
(Bent Position with 30x30cm Metal Ground Edge)**

XY Plane

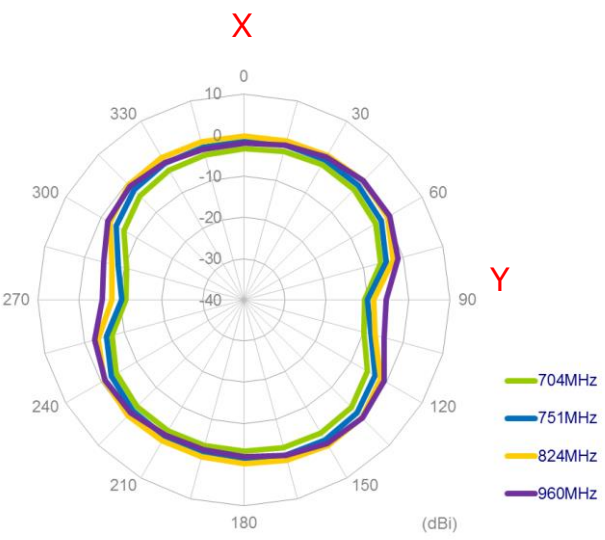

XY Plane

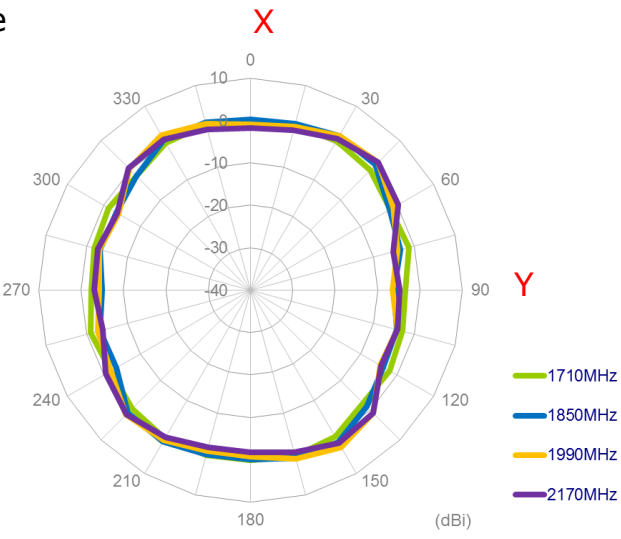

XY Plane

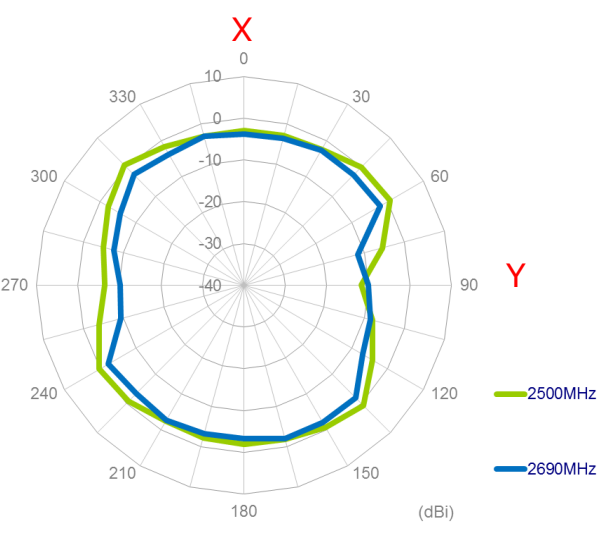

XY Plane

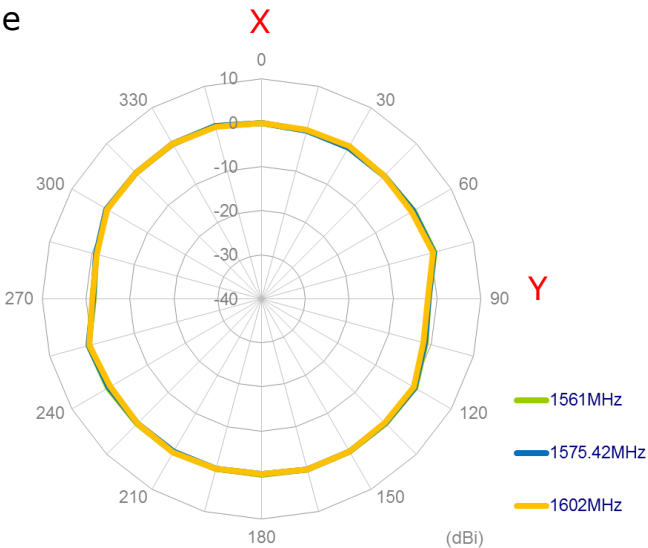

XZ Plane

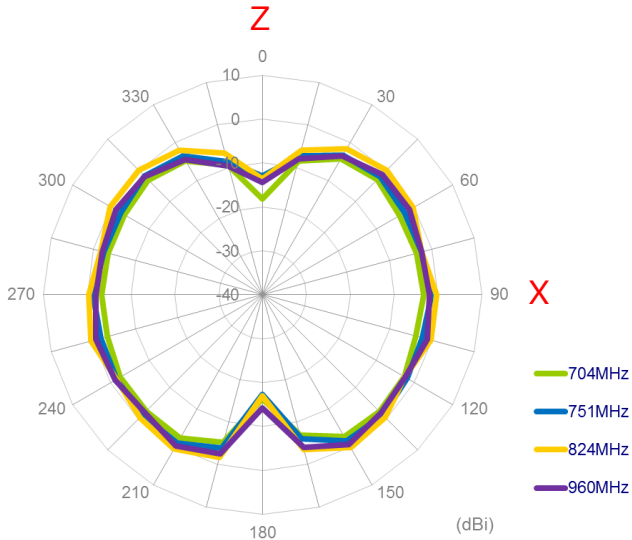

XZ Plane

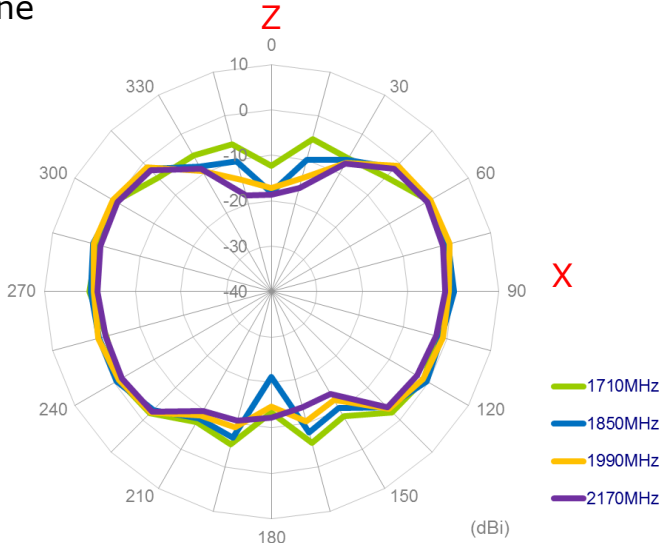

XZ Plane

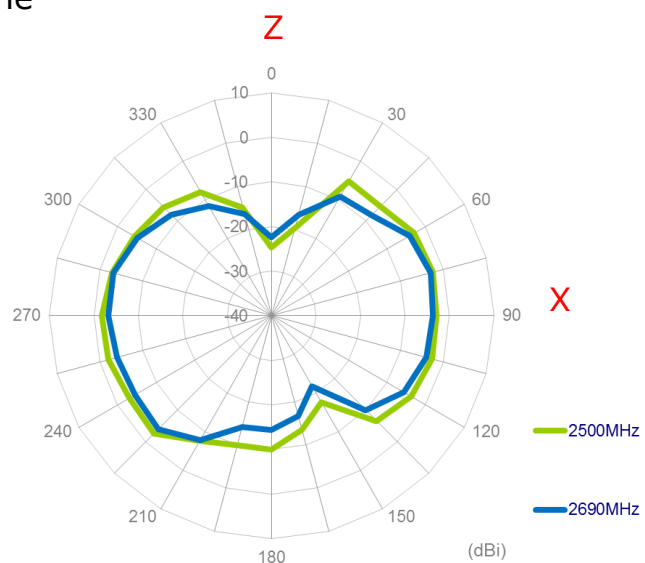

XZ Plane

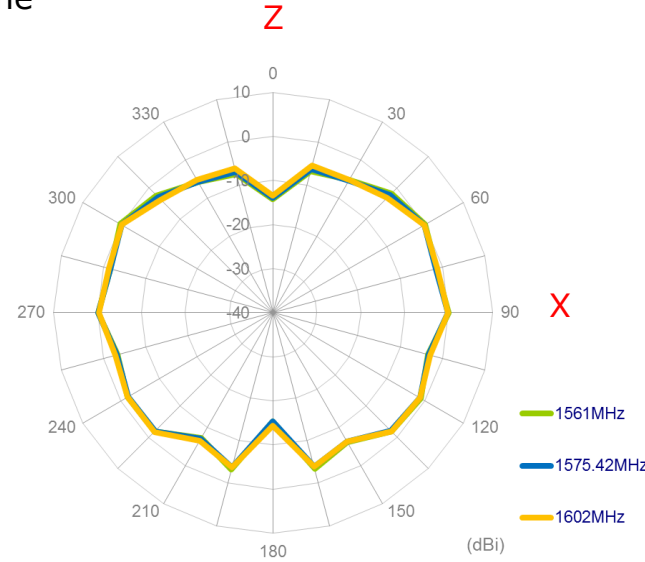

YZ Plane

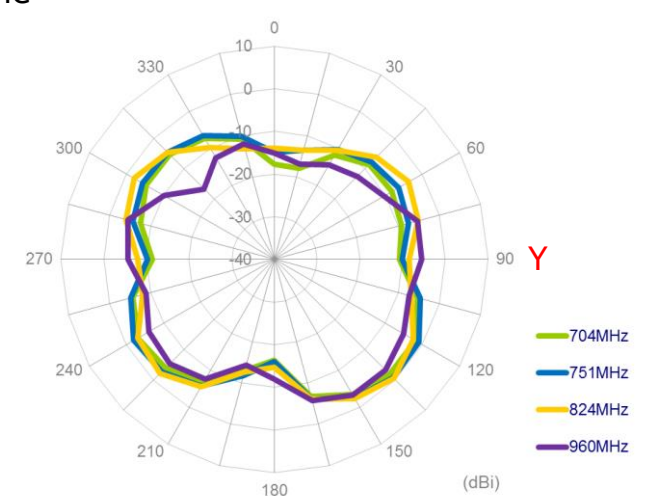

YZ Plane

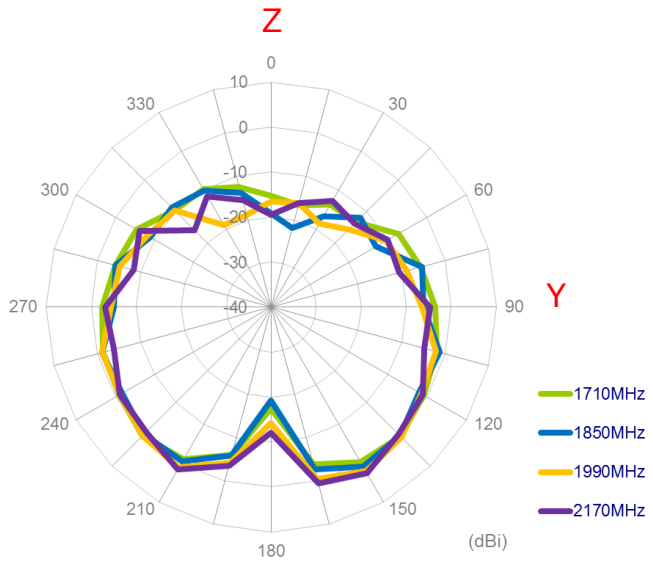

YZ Plane

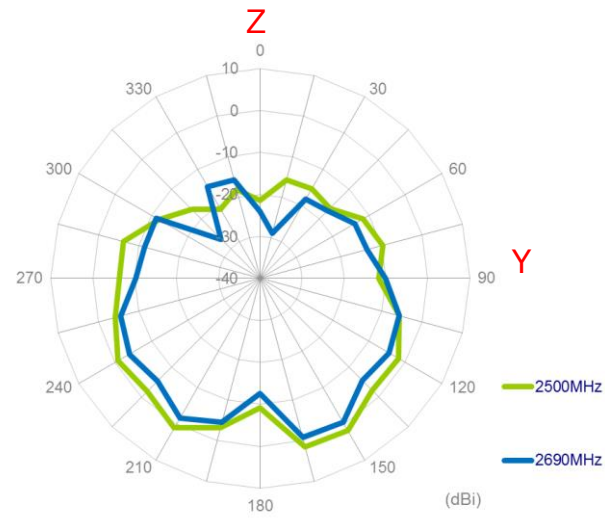

YZ Plane

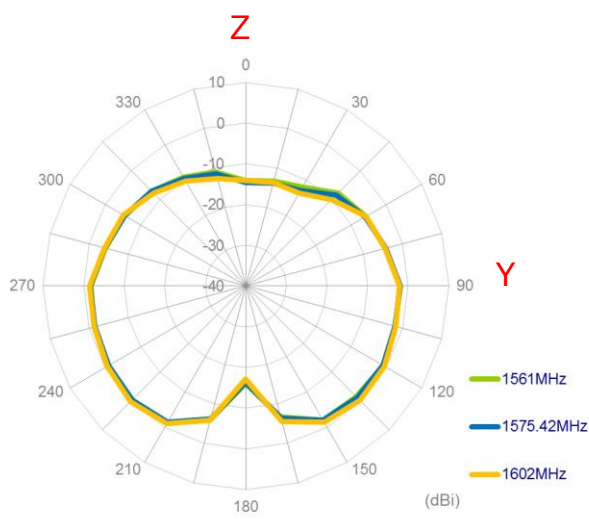

**2D Radiation Pattern
(Bent Position with 30*30cm Metal Ground Center)**

X

XY Plane

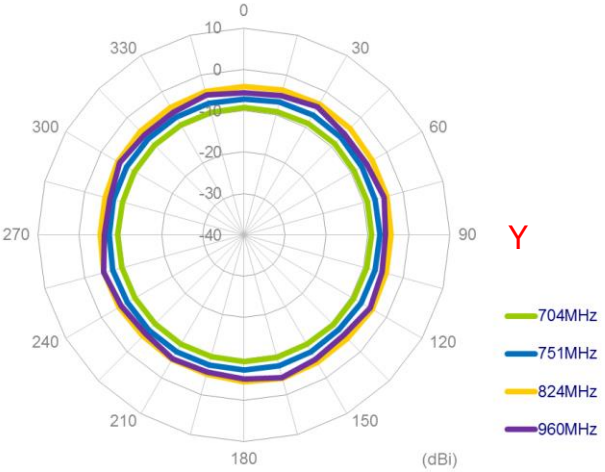

XY Plane

X

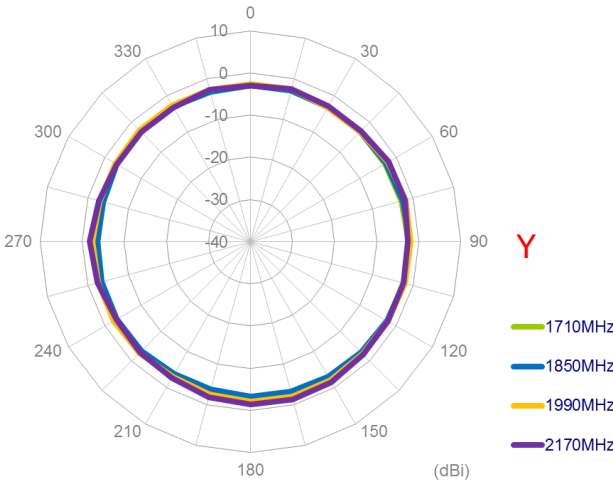

XY Plane

X

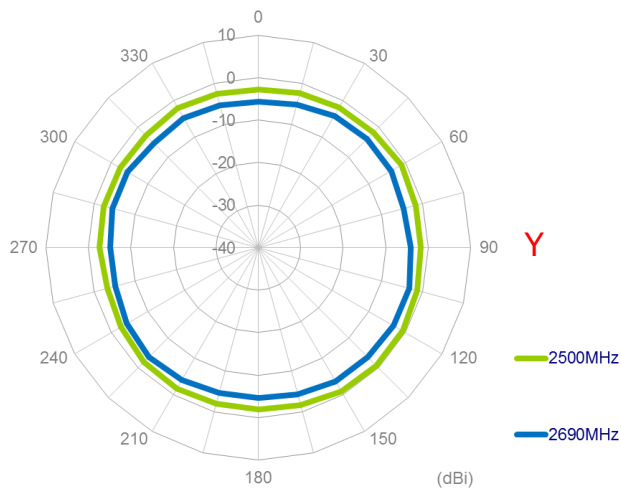

XY Plane

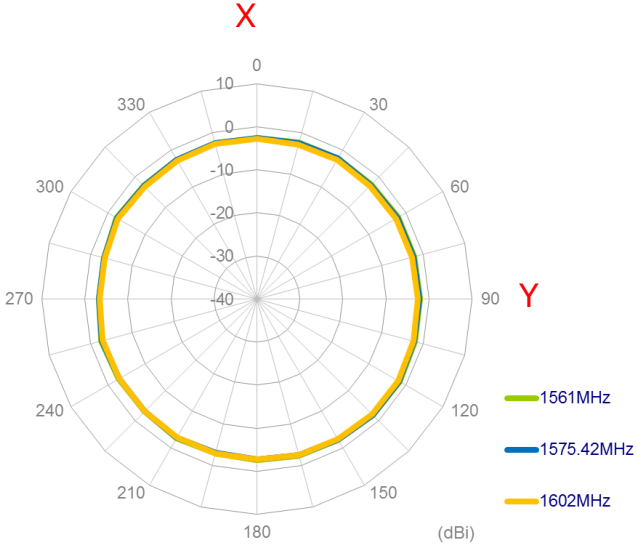

XZ Plane

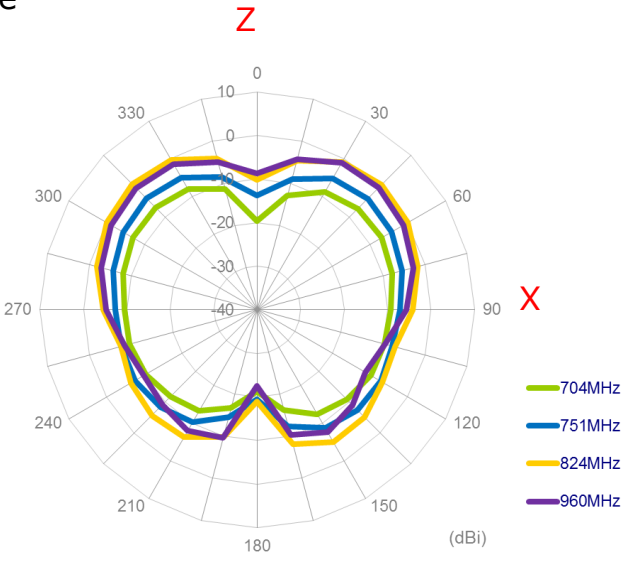

XZ Plane

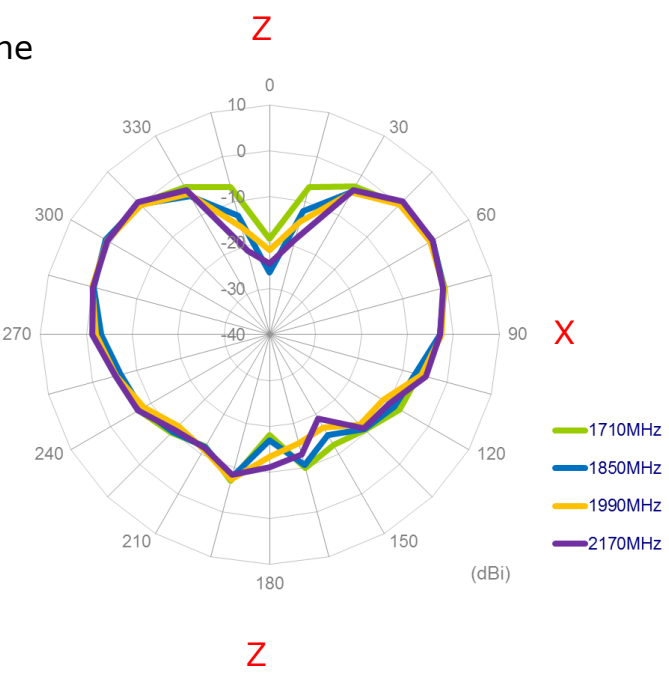

XZ Plane

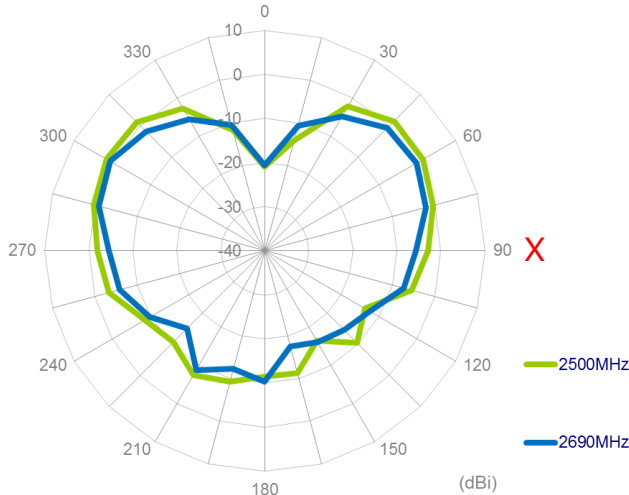

XZ Plane

Z

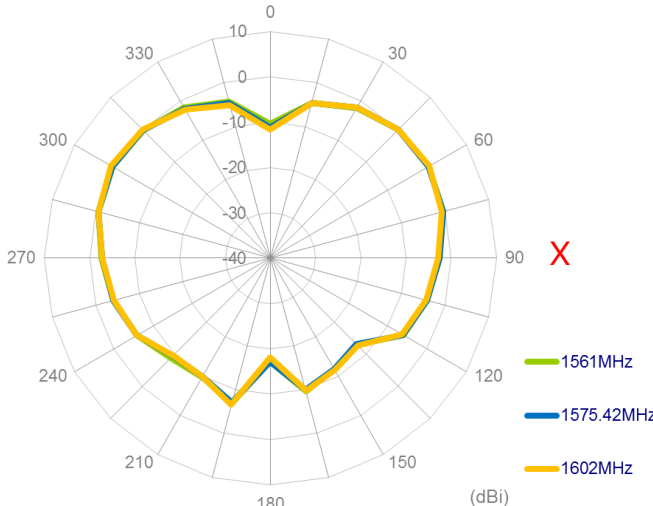

YZ Plane

Z

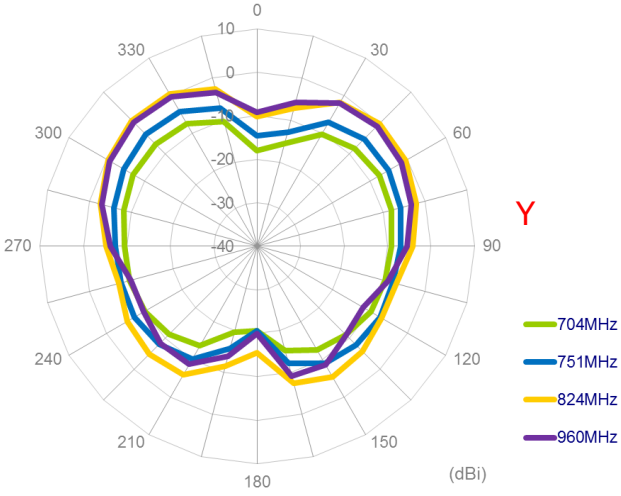

YZ Plane

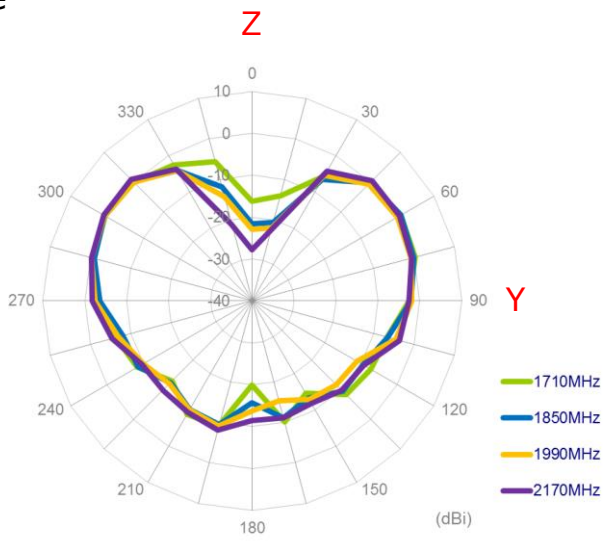

YZ Plane

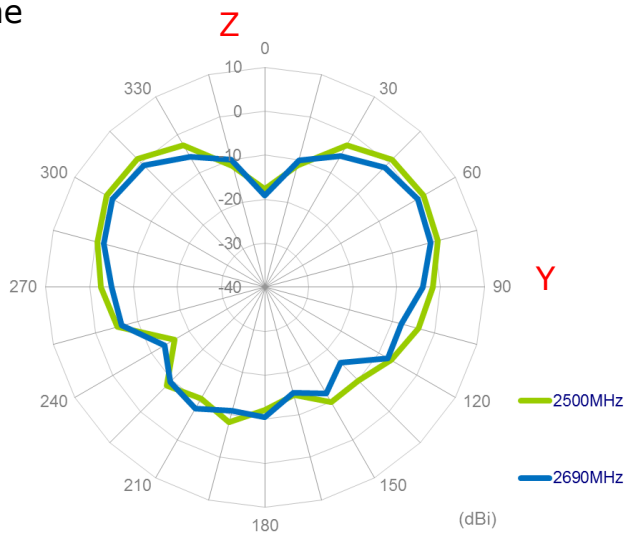

YZ Plane

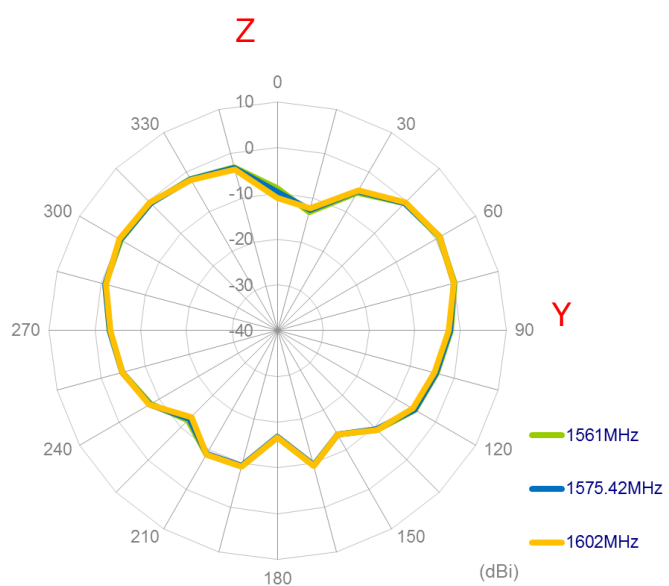

**3D Radiation Pattern
(Straight Position in Free Space)**

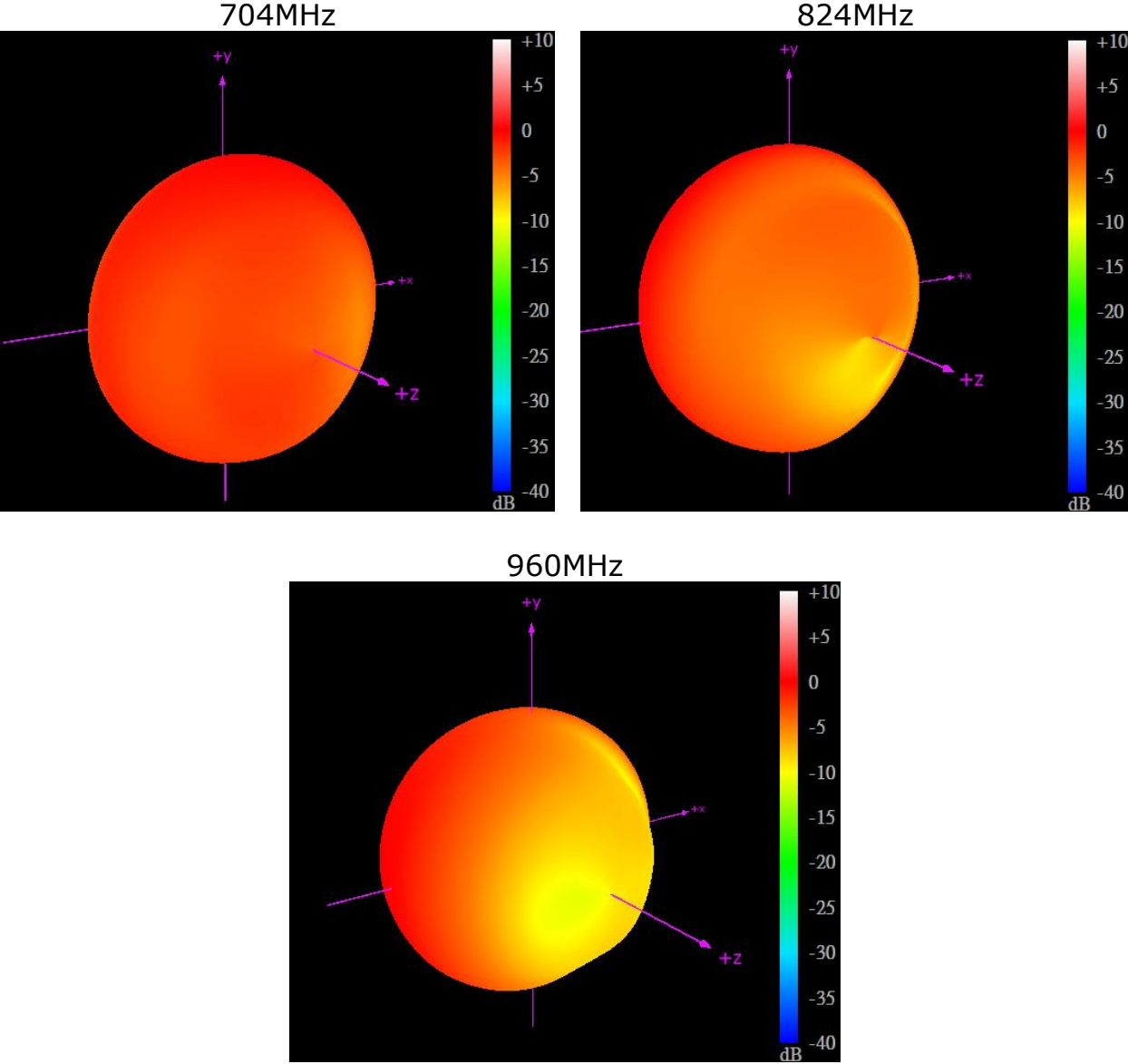

1561MHz

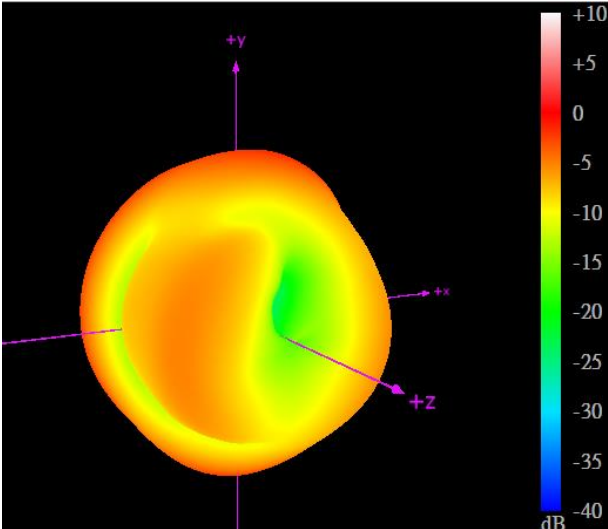

1575.42MHz

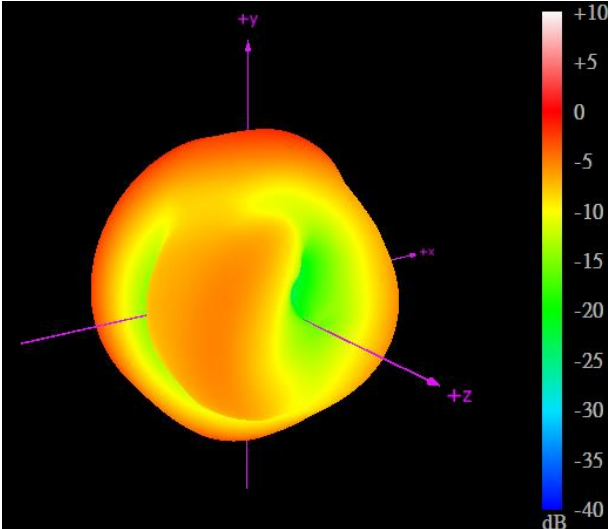

1602MHz

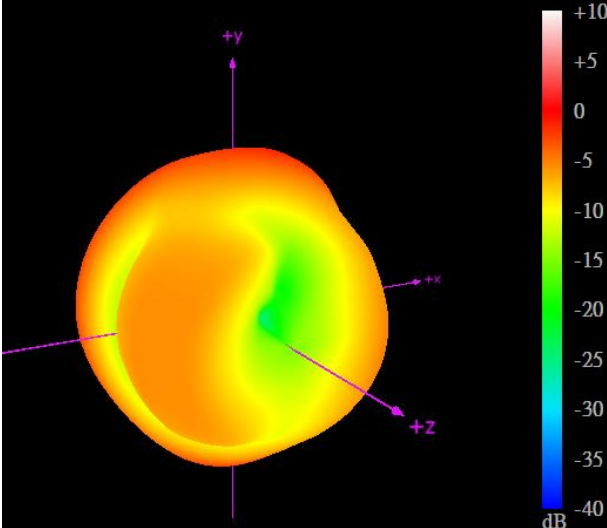

1710MHz

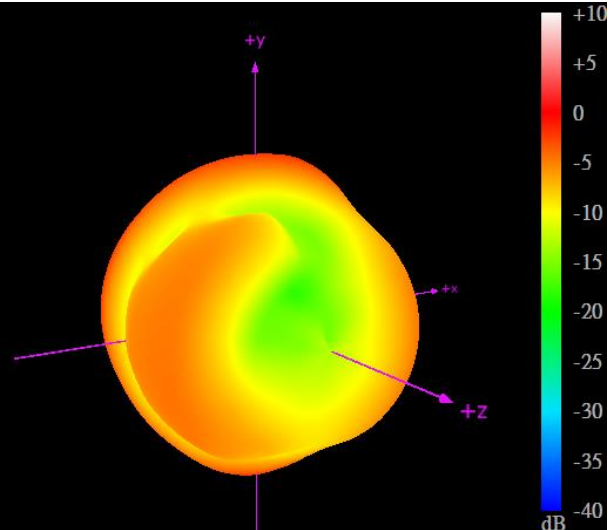

2170MHz

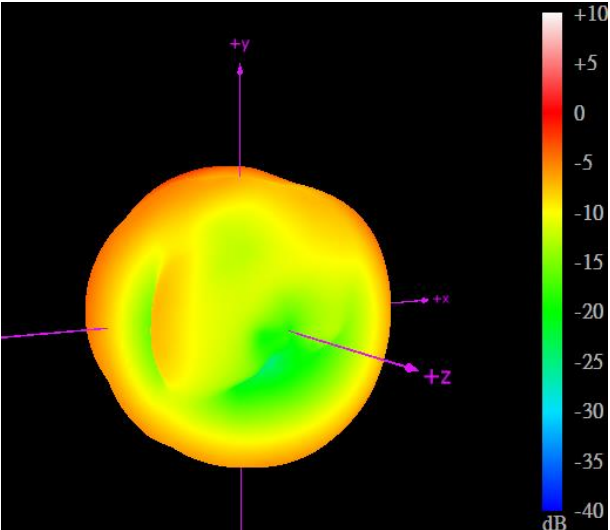

2690MHz

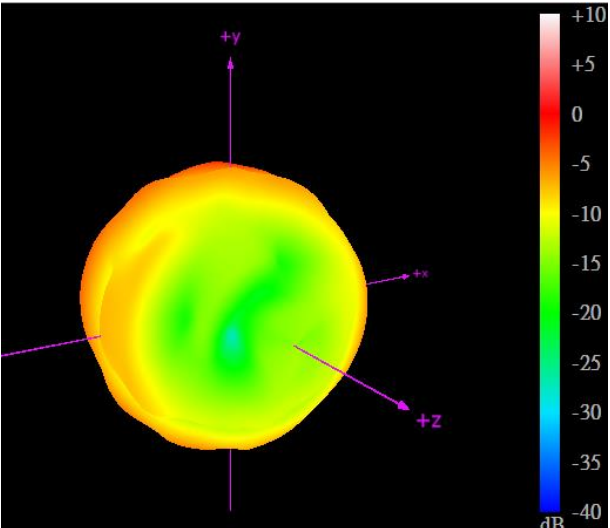

**3D Radiation Pattern
(Straight Position with 15x9cm Ground)**

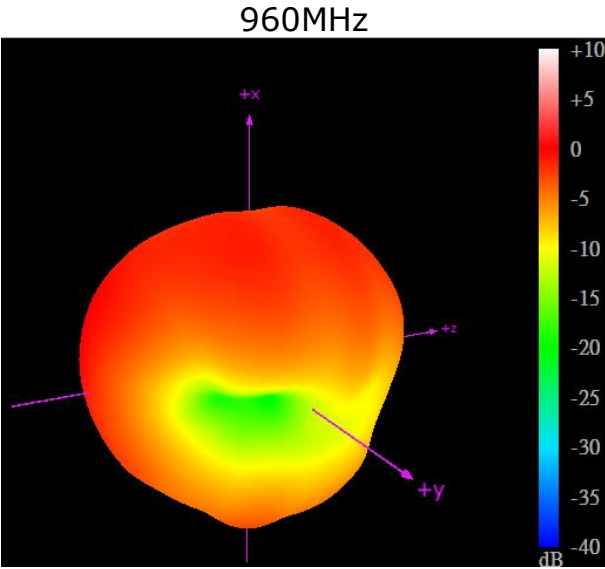
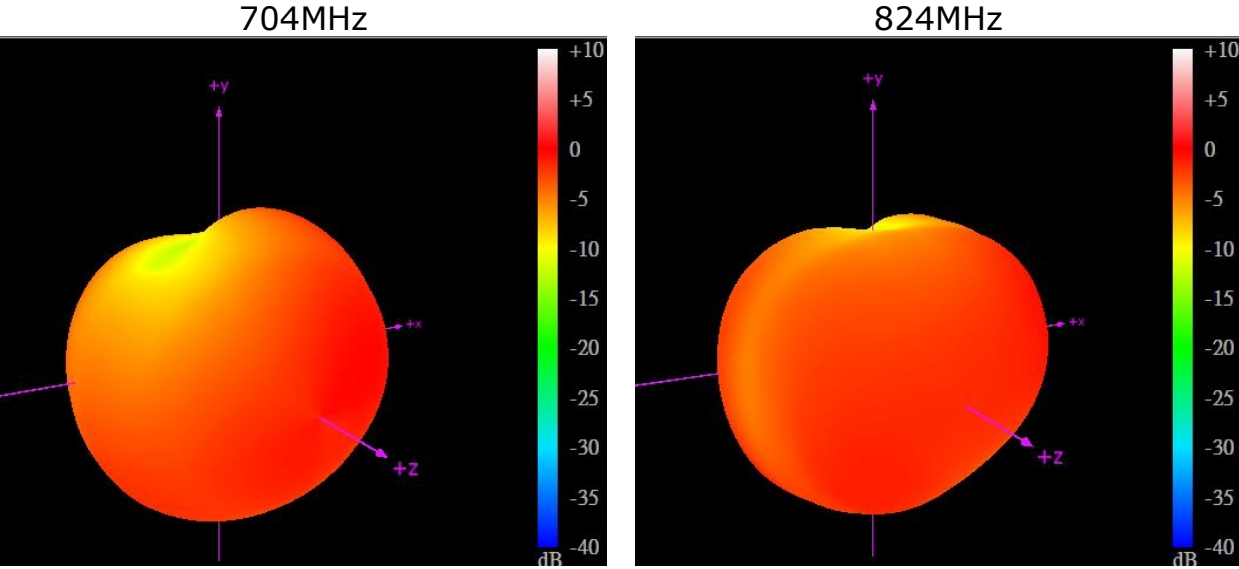

1561MHz

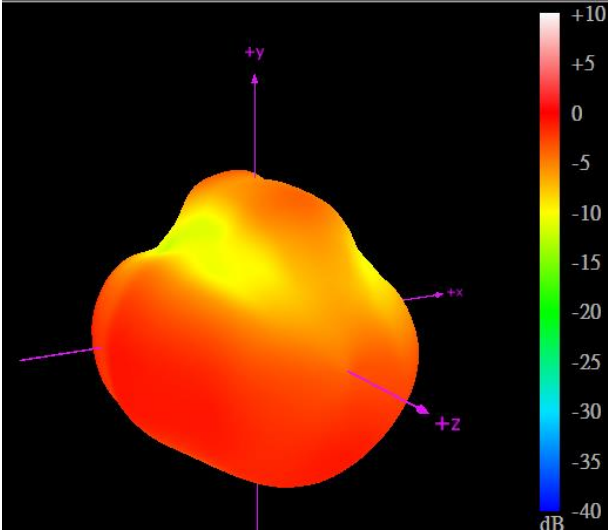

1575.42MHz

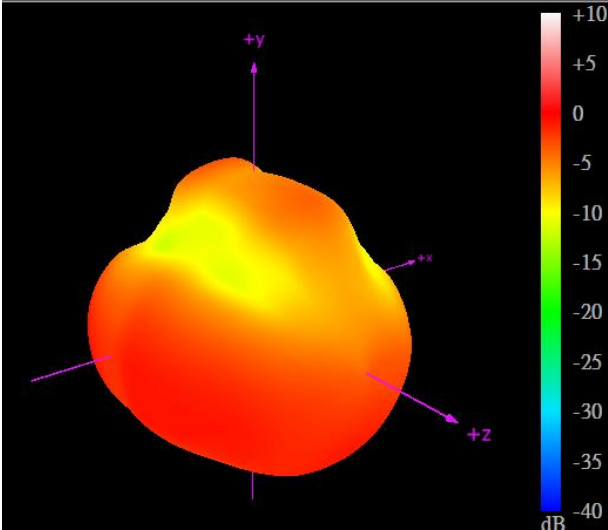

1602MHz

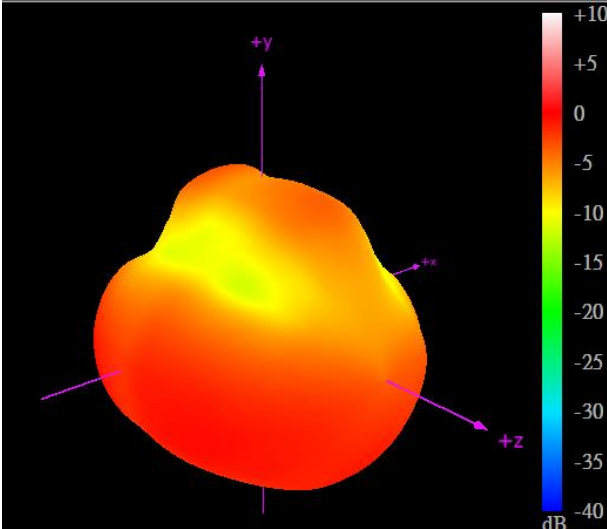

1710MHz

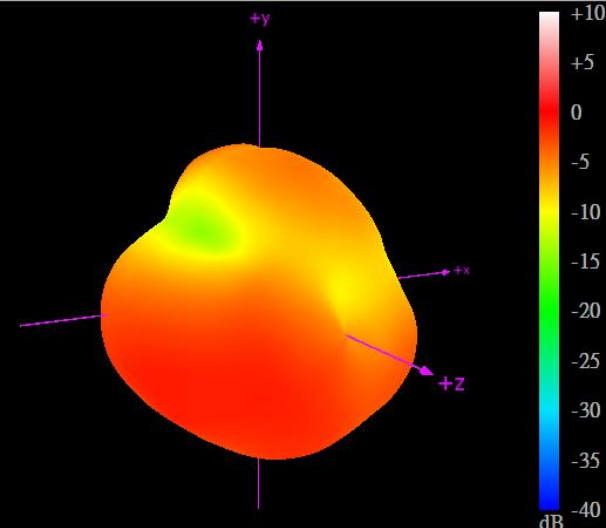

2170MHz

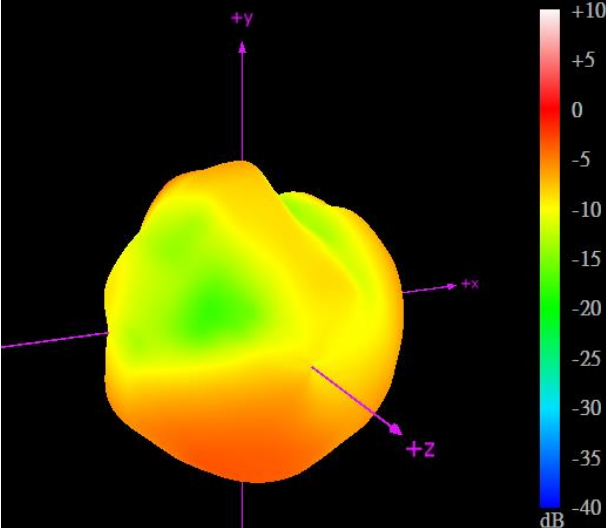

2690MHz

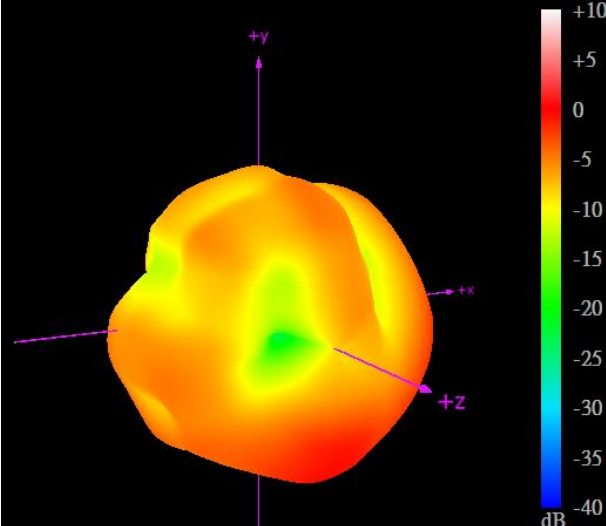

**3D Radiation Pattern
(Straight Position with 30x30cm Metal Ground Edge)**

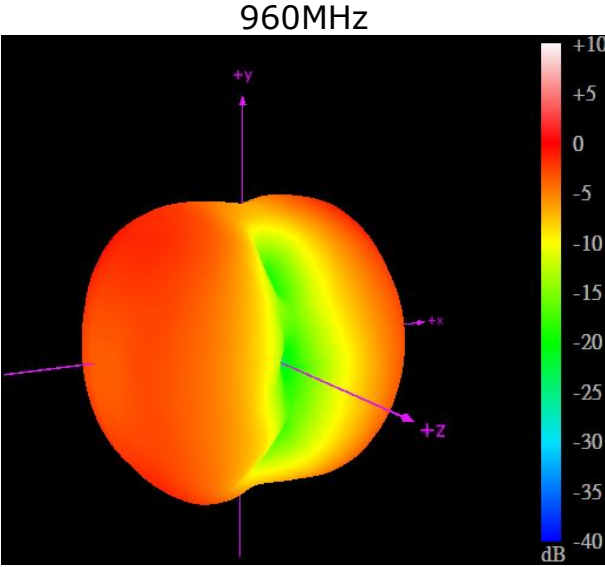
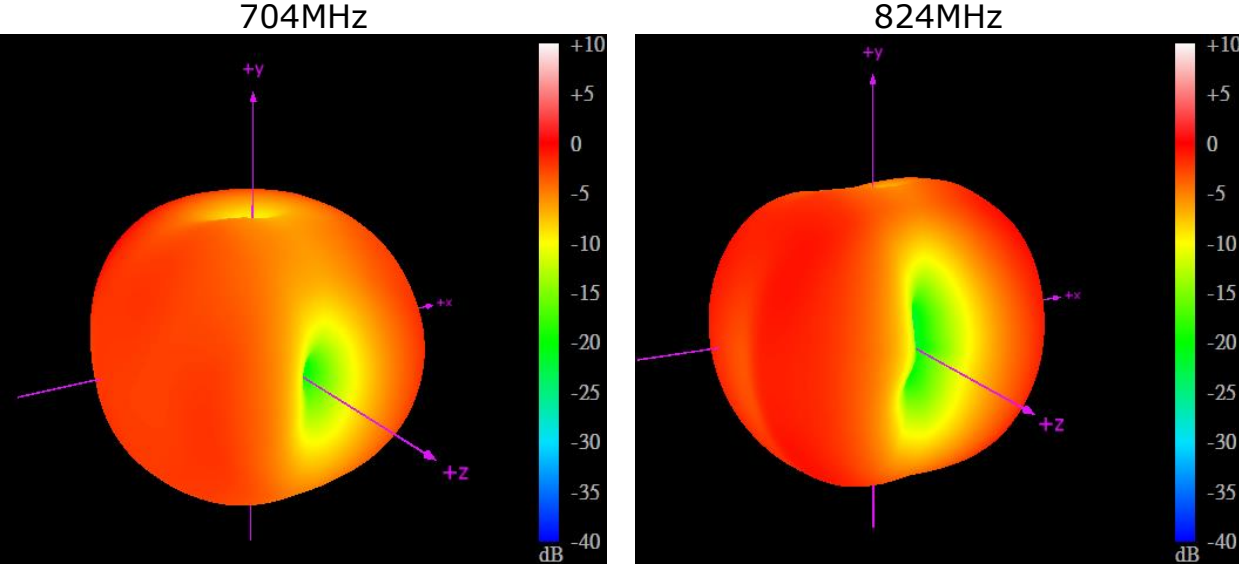

1561MHz

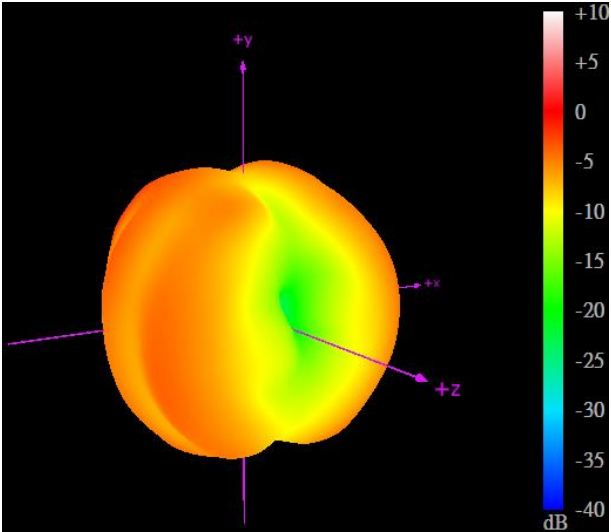

1575.42MHz

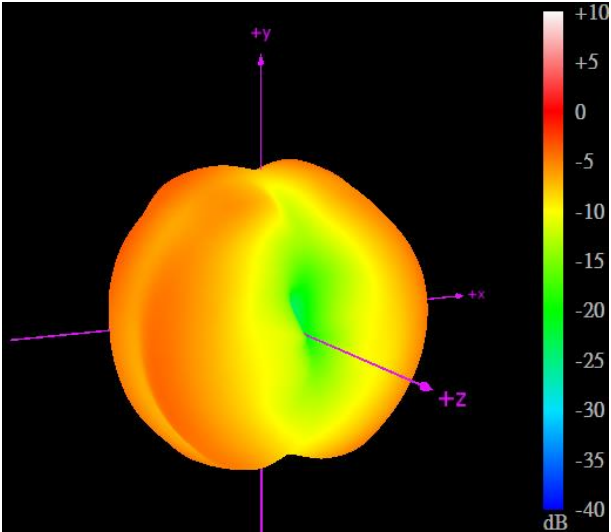

1602MHz

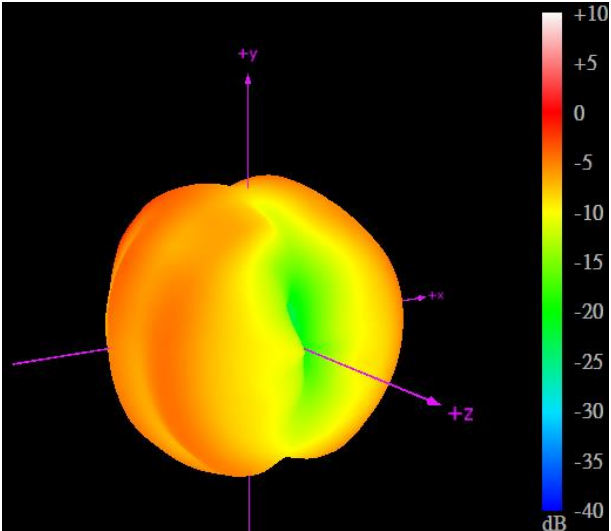

1710MHz

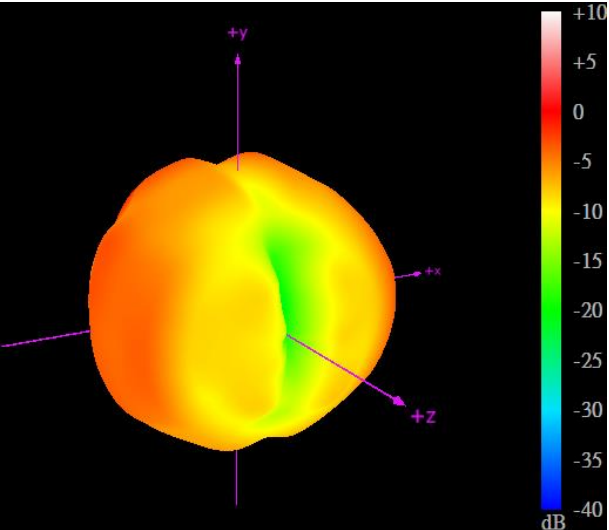

2170MHz

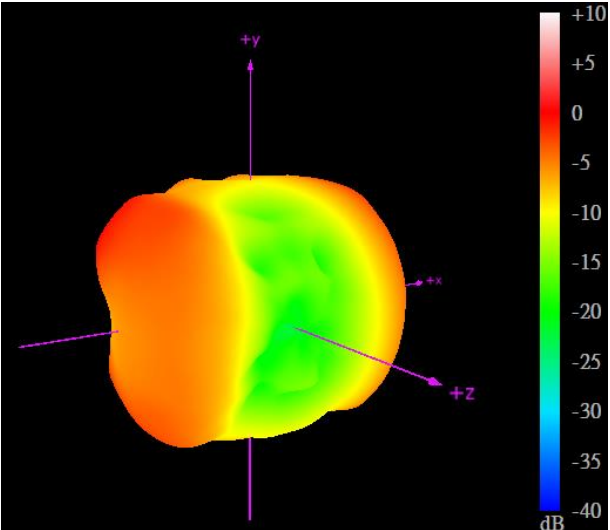

2690MHz

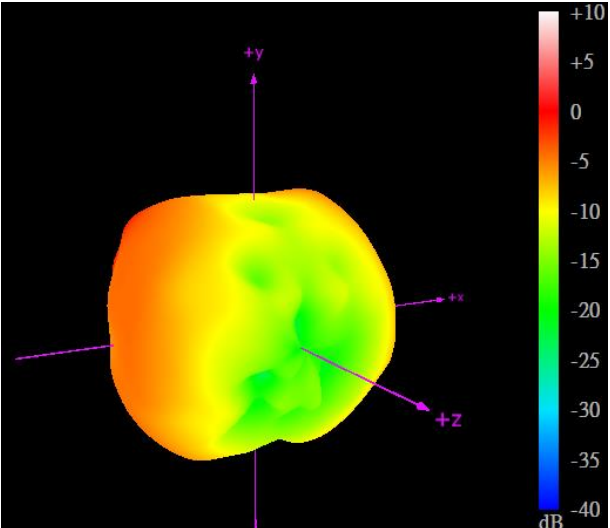

**3D Radiation Pattern
(Straight Position with 30x30cm Metal Ground Center)**

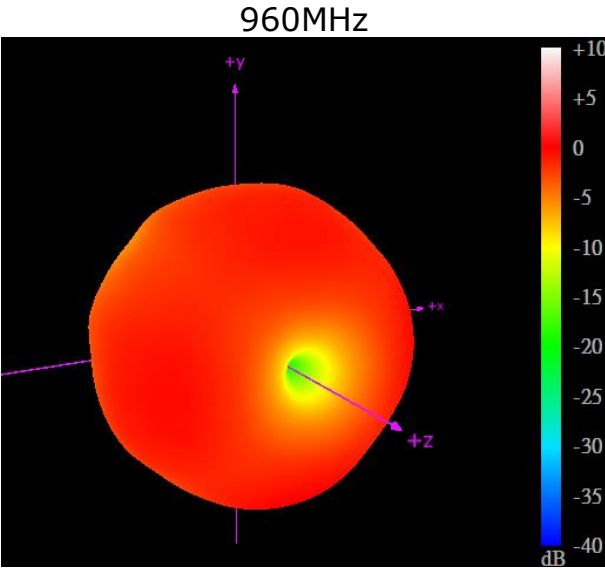
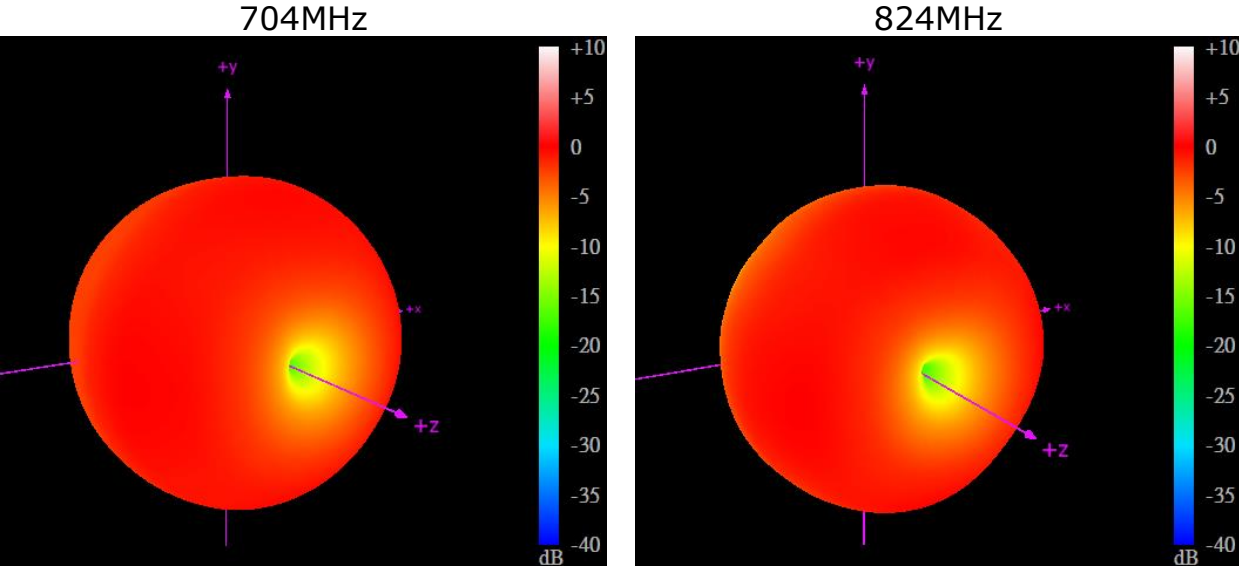

1561MHz

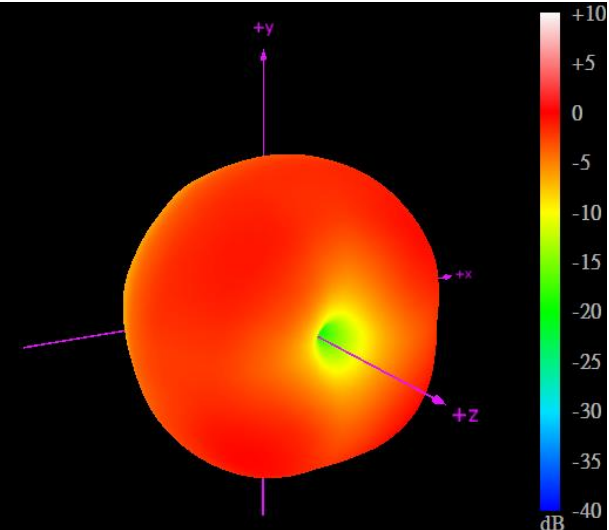

1575.42MHz

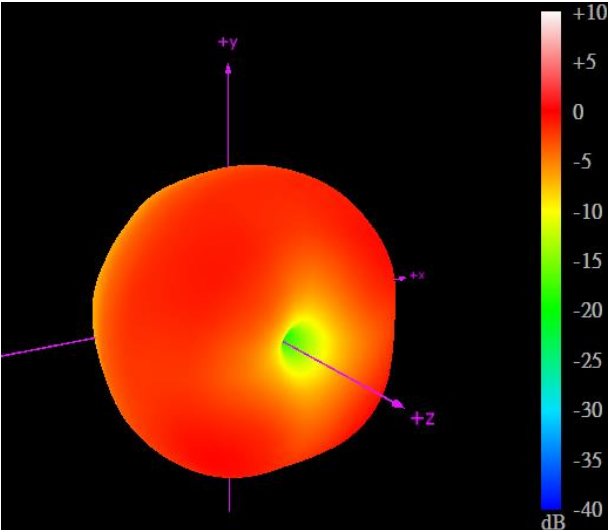

1602MHz

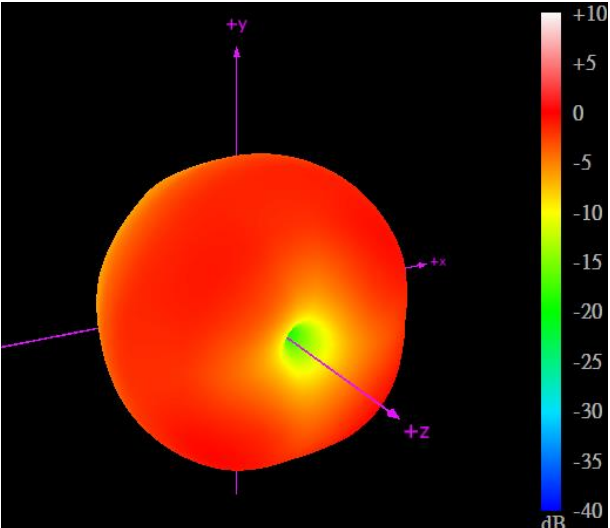

1710MHz

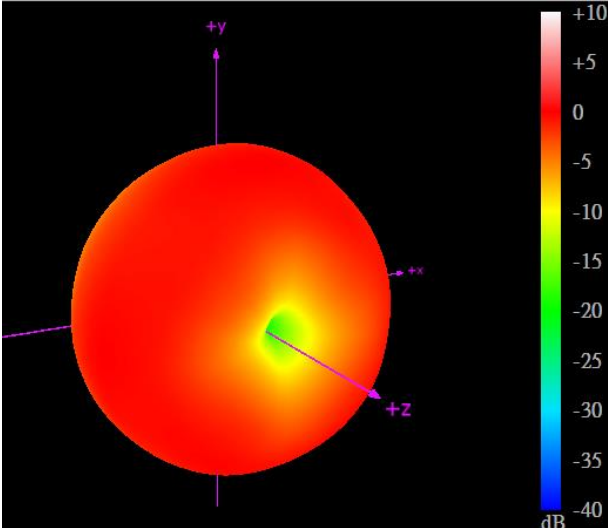

2170MHz

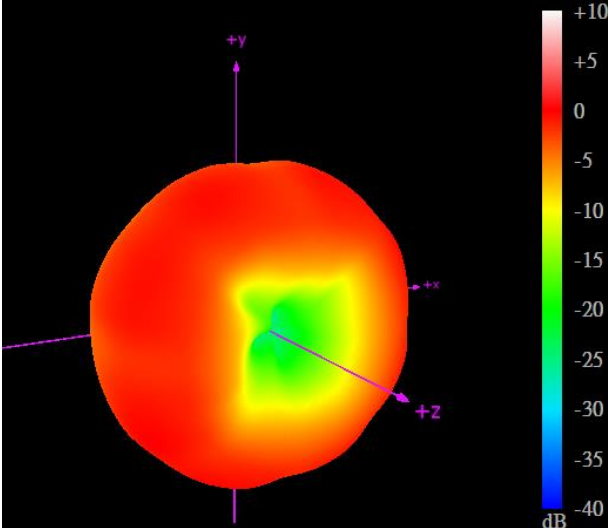

2690MHz

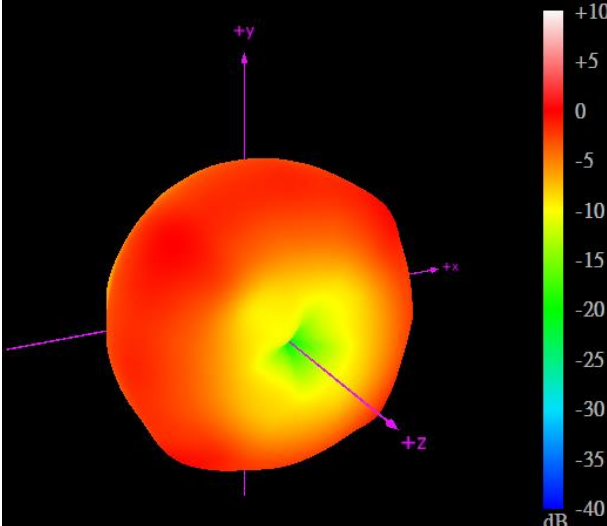

**3D Radiation Pattern
(Bent Position with in Free Space)**

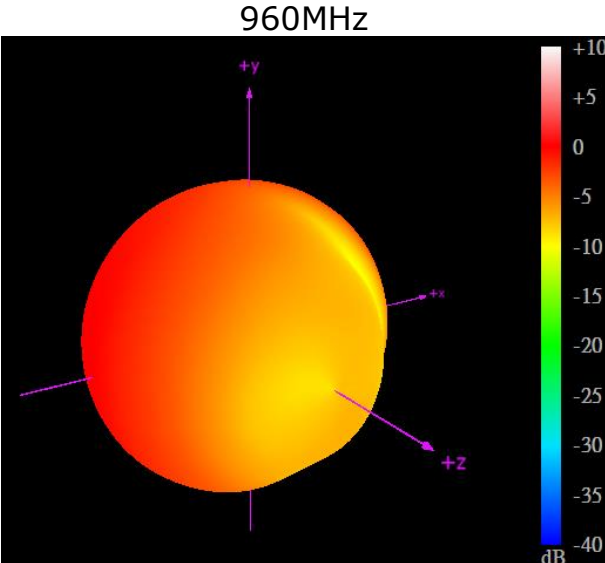
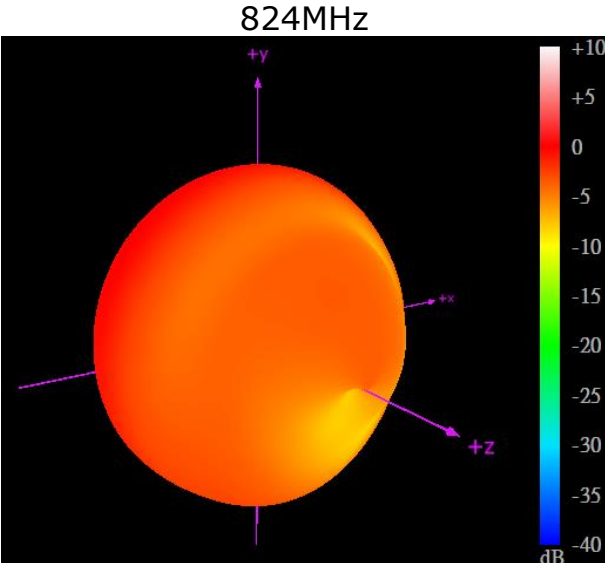
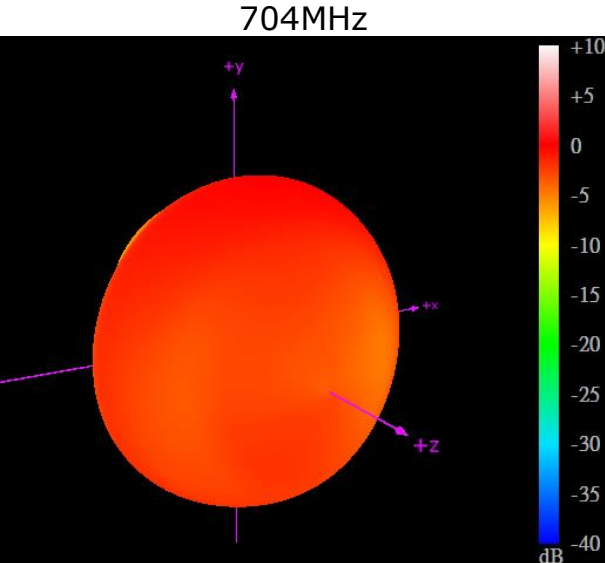

1561MHz

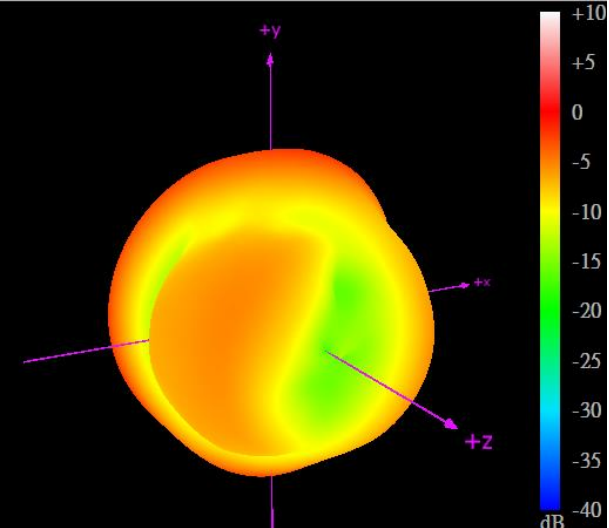

1575.42MHz

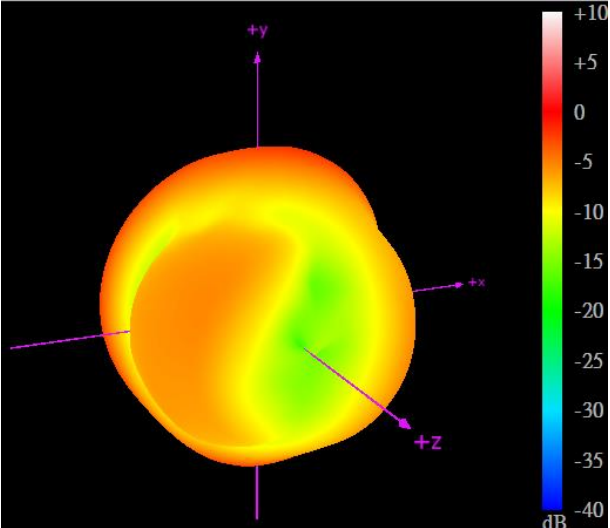

1602MHz

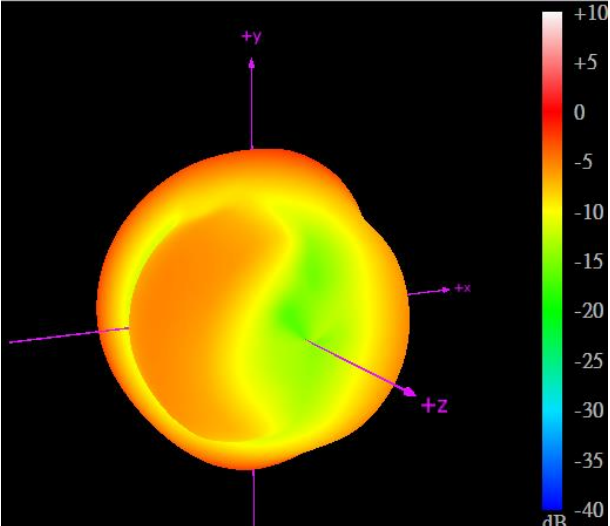

1710MHz

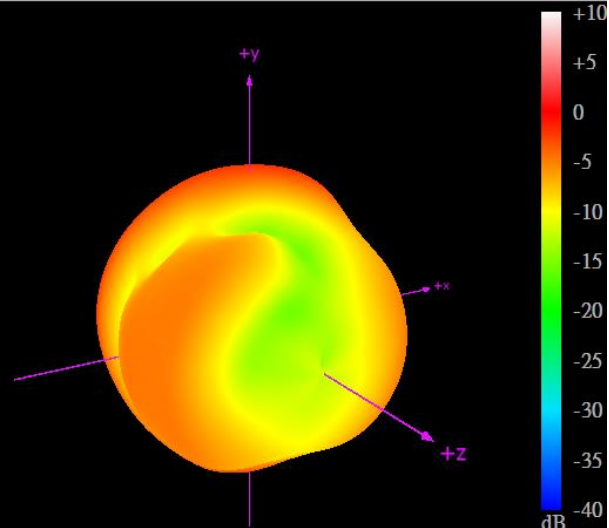

2170MHz

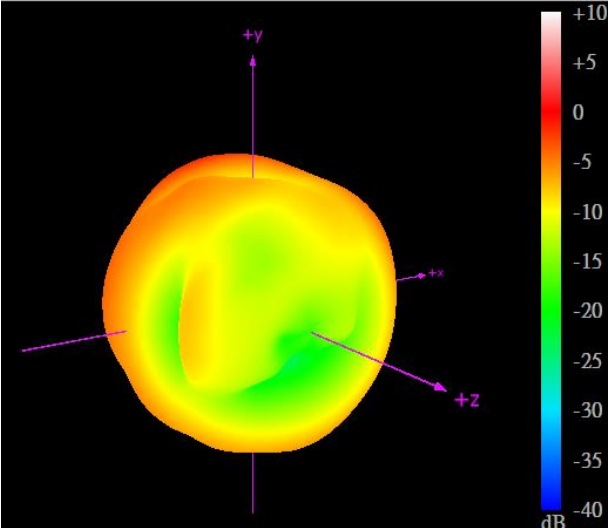

2690MHz

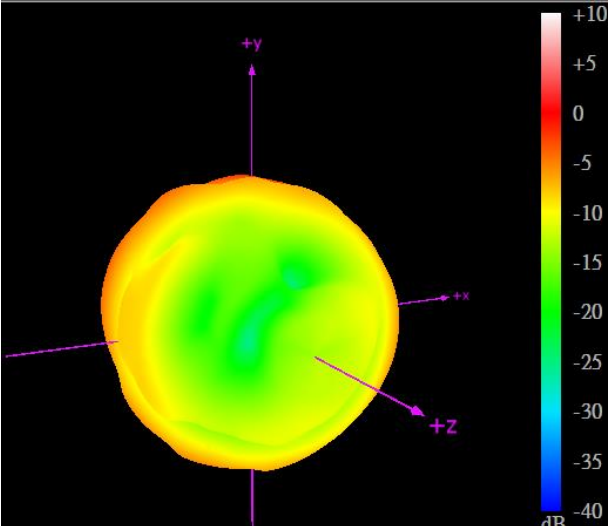

**3D Radiation Pattern
(Bent Position with 15x9cm Ground)**

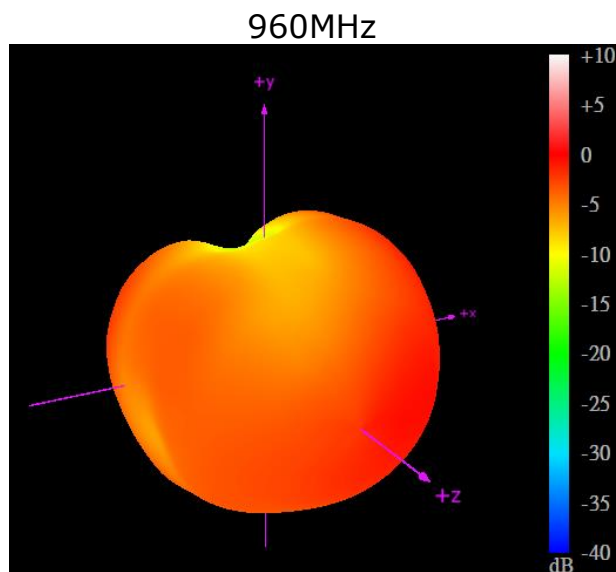
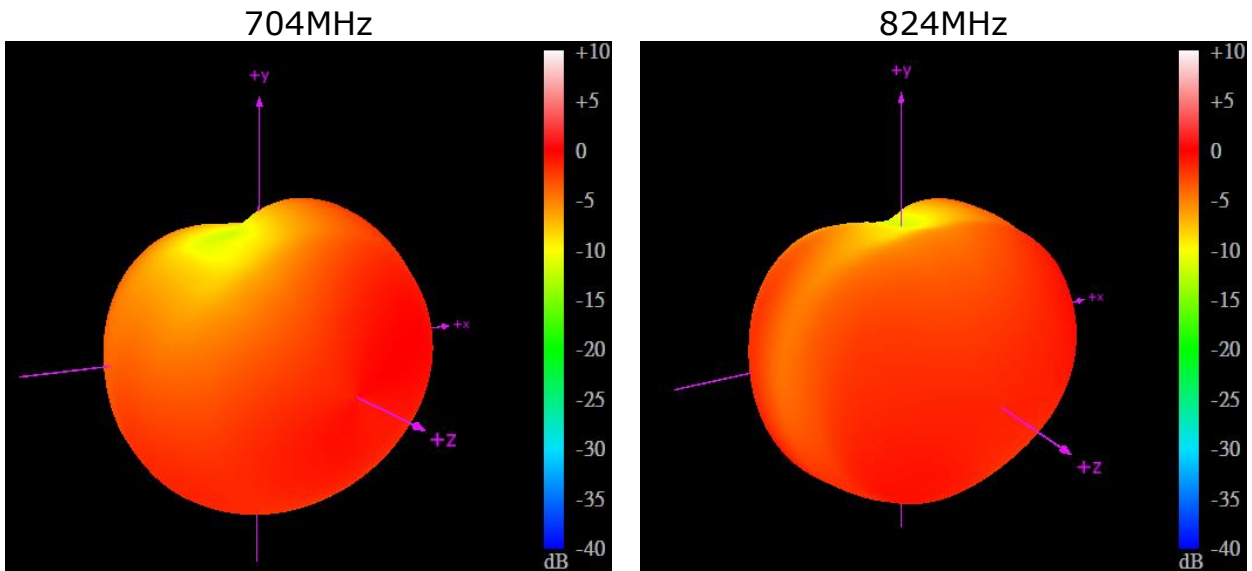

1561MHz

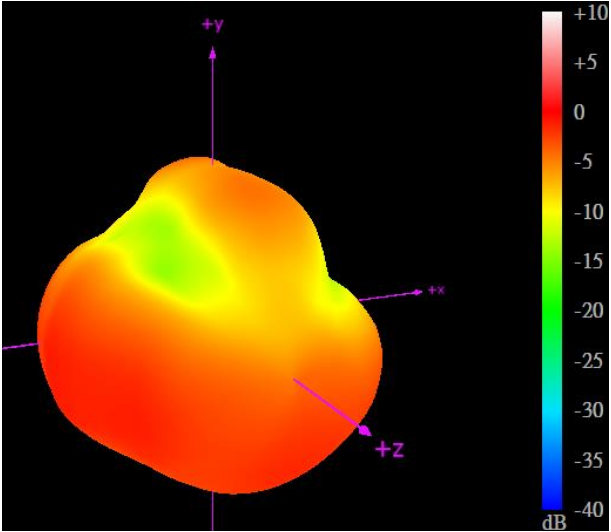

1575.42MHz

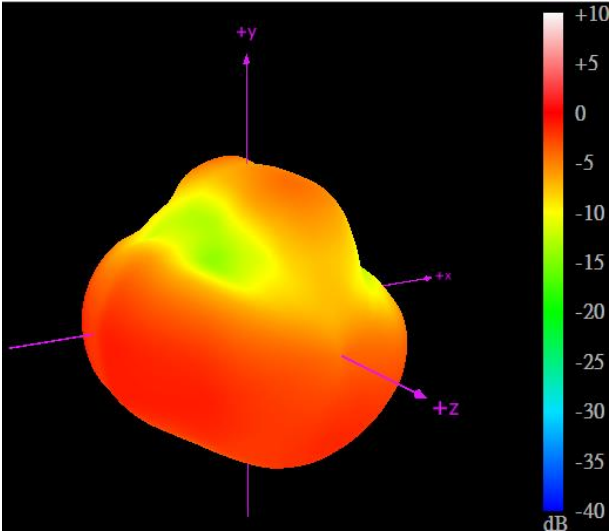

1602MHz

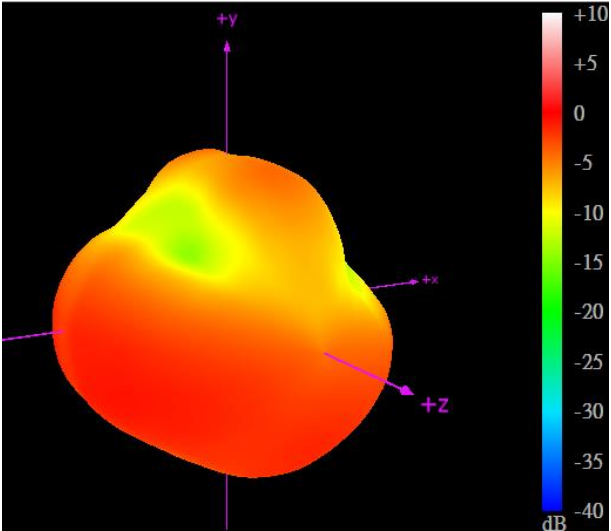

1710MHz

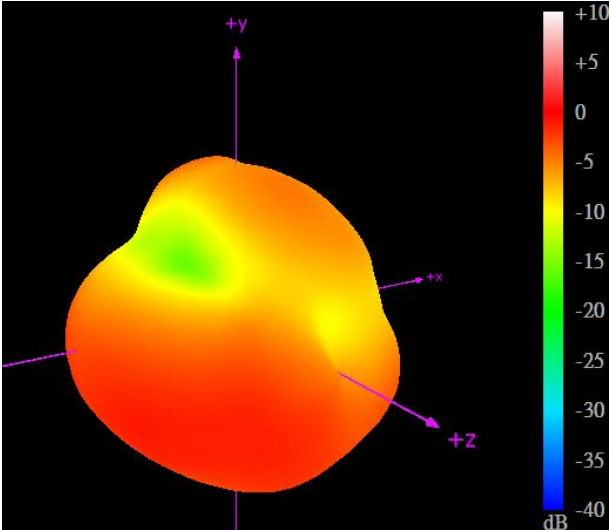

2170MHz

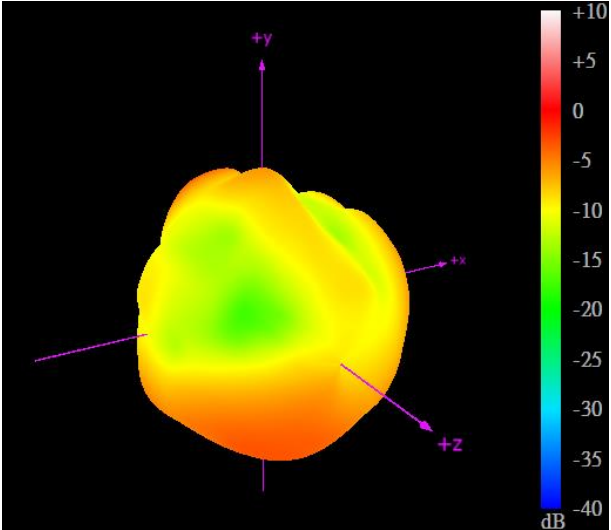

2690MHz

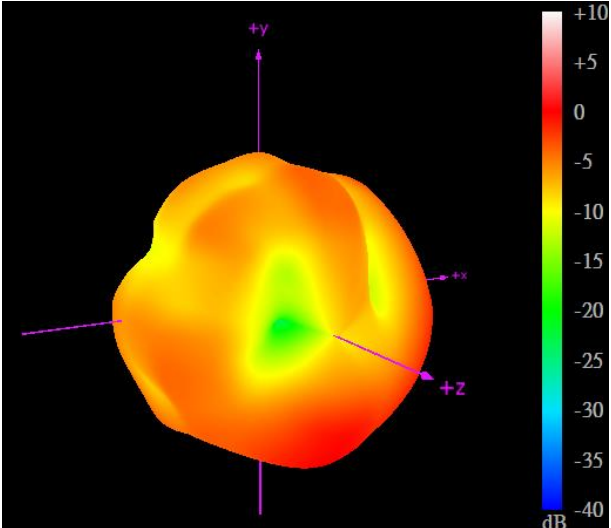

**3D Radiation Pattern
(Bent Position with 30x30cm Metal Ground Edge)**

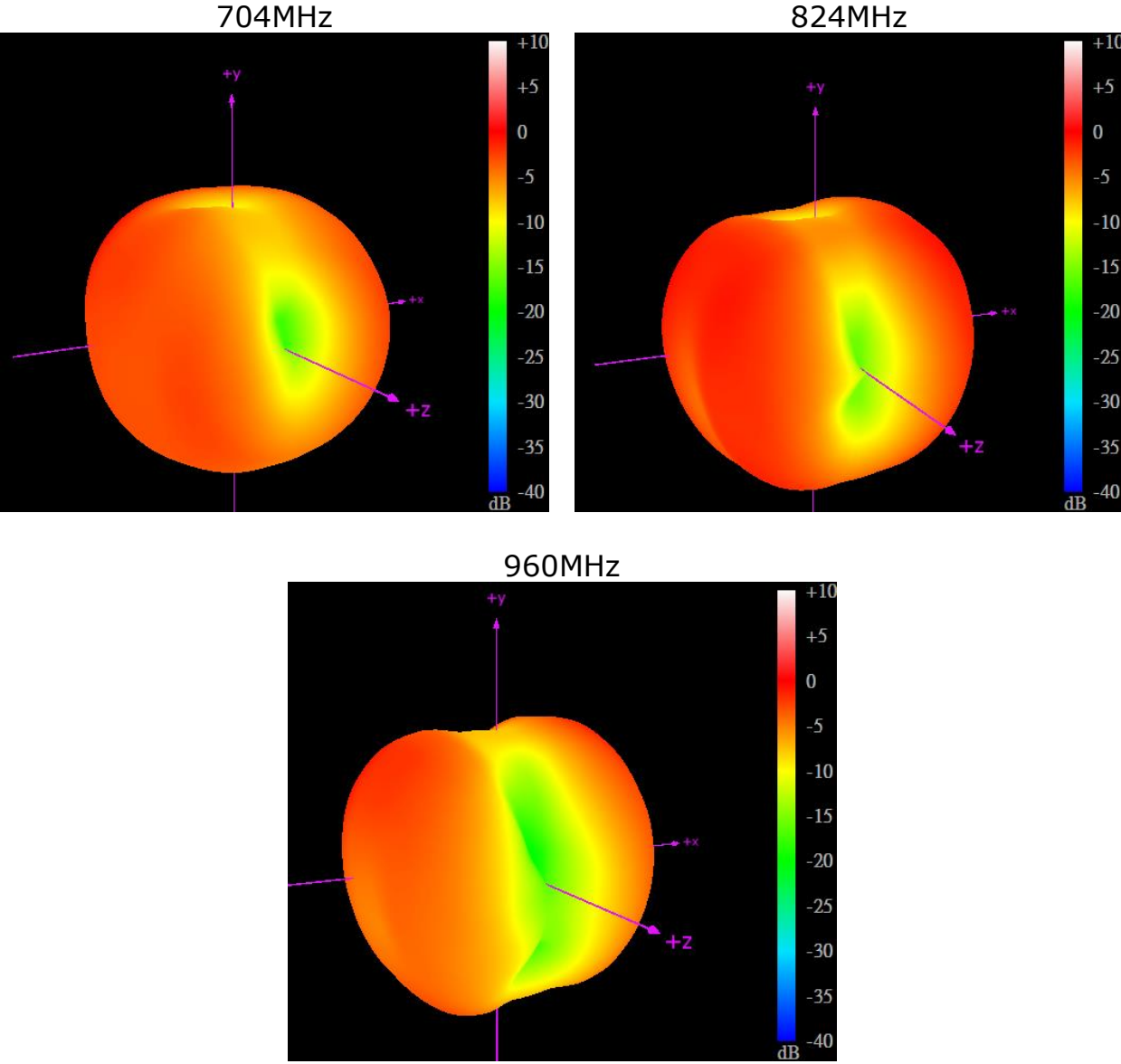

1561MHz

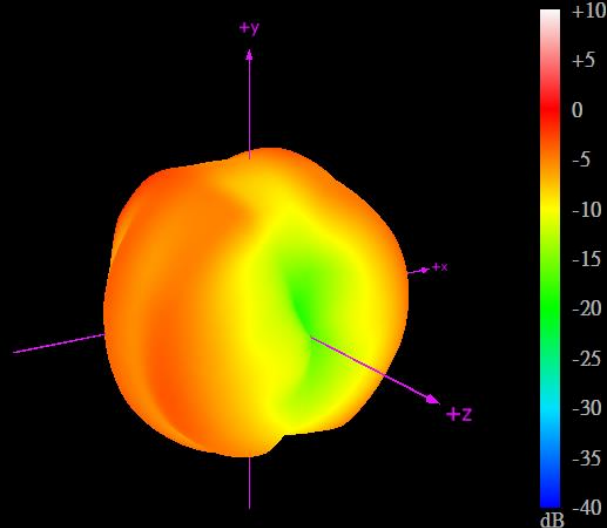

1575.42MHz

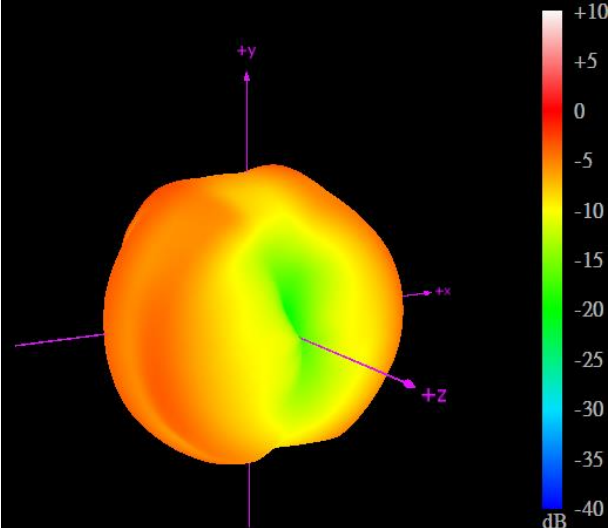

1602MHz

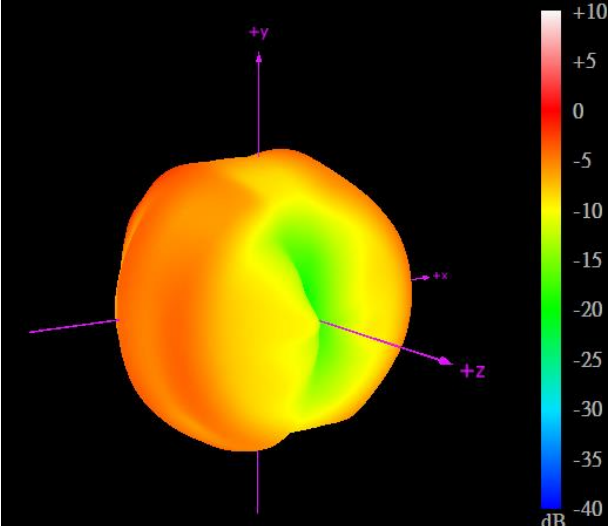

1710MHz

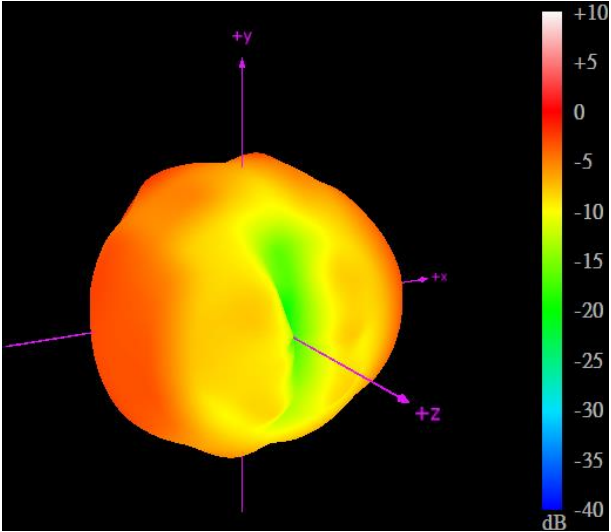

2170MHz

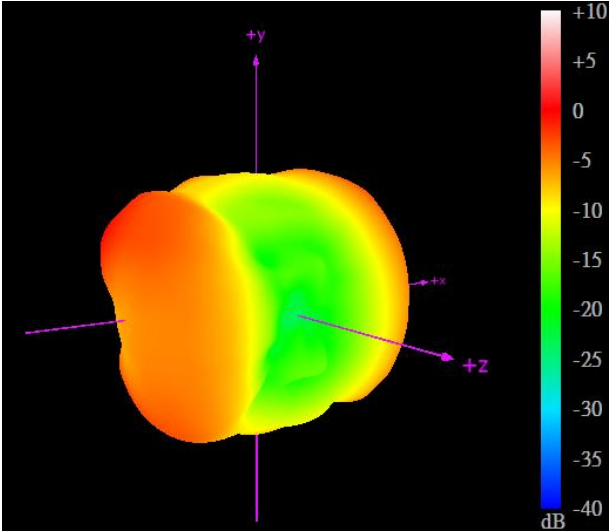

2690MHz

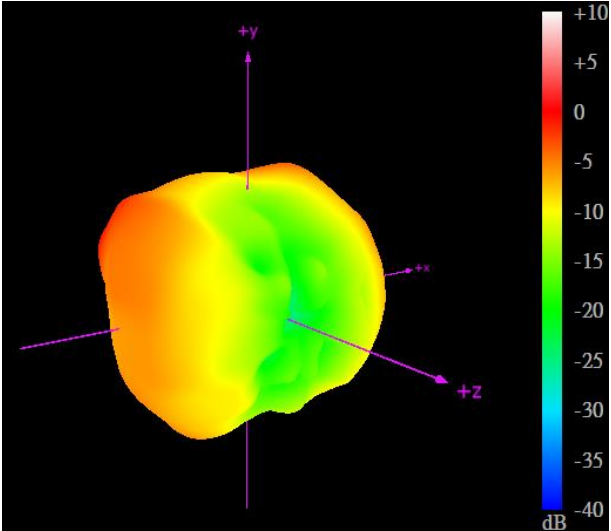

**3D Radiation Pattern
(Bent Position with 30x30cm Metal Ground Center)**

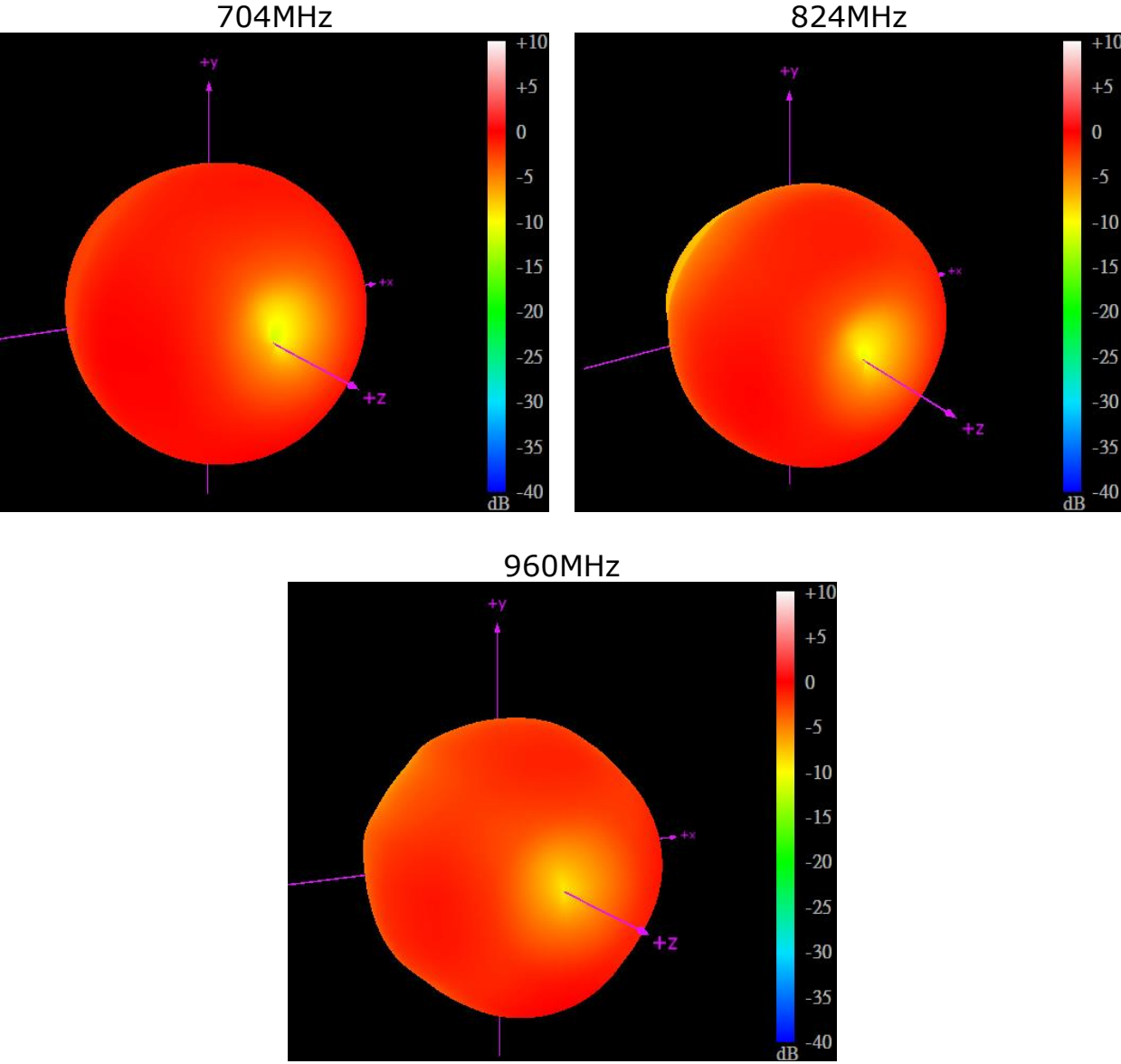

1561MHz

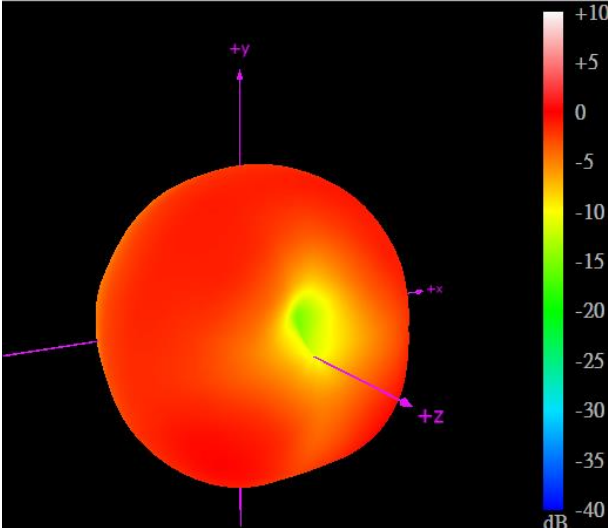

1575.42MHz

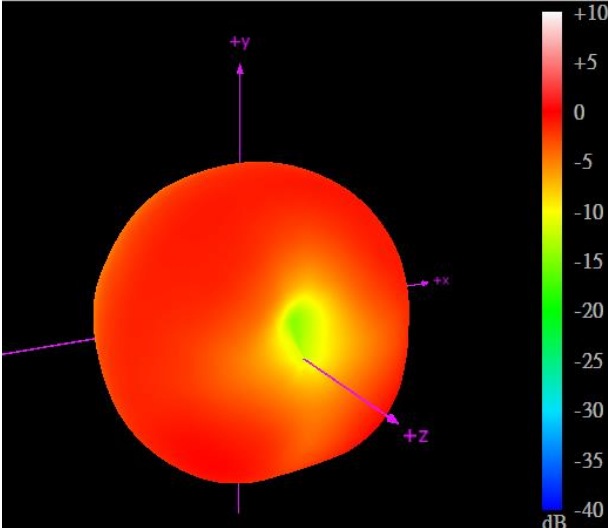

1602MHz

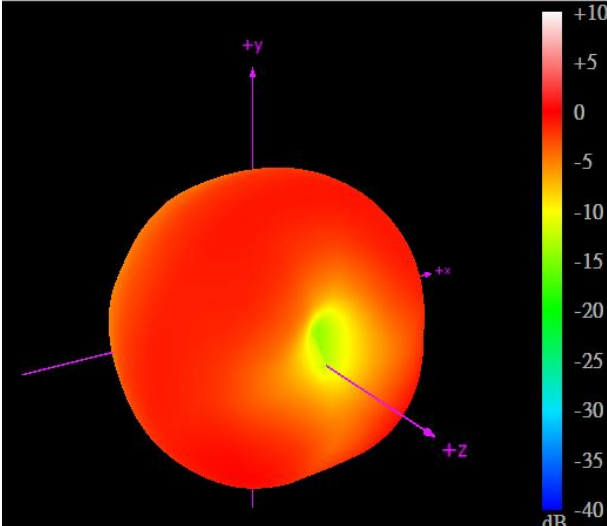

1710MHz

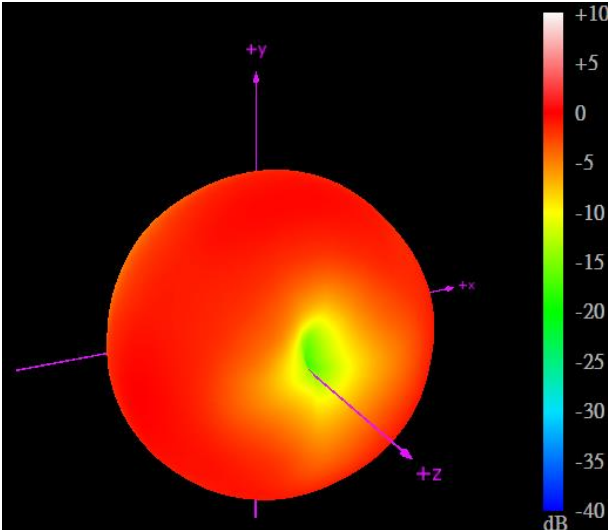

2170MHz

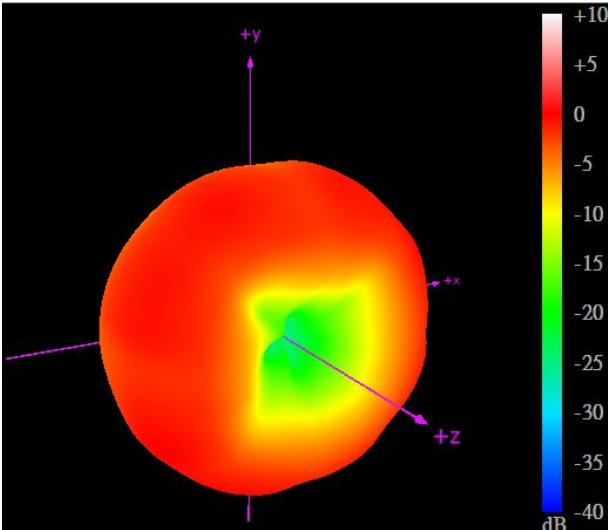

2690MHz

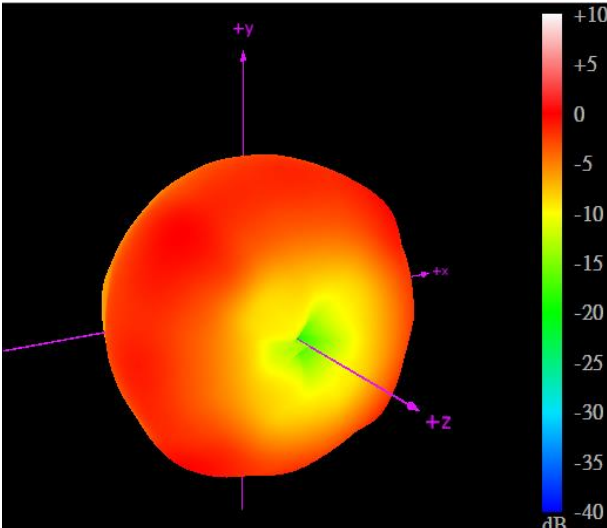

3. Mechanical Drawing

(Unit:mm)

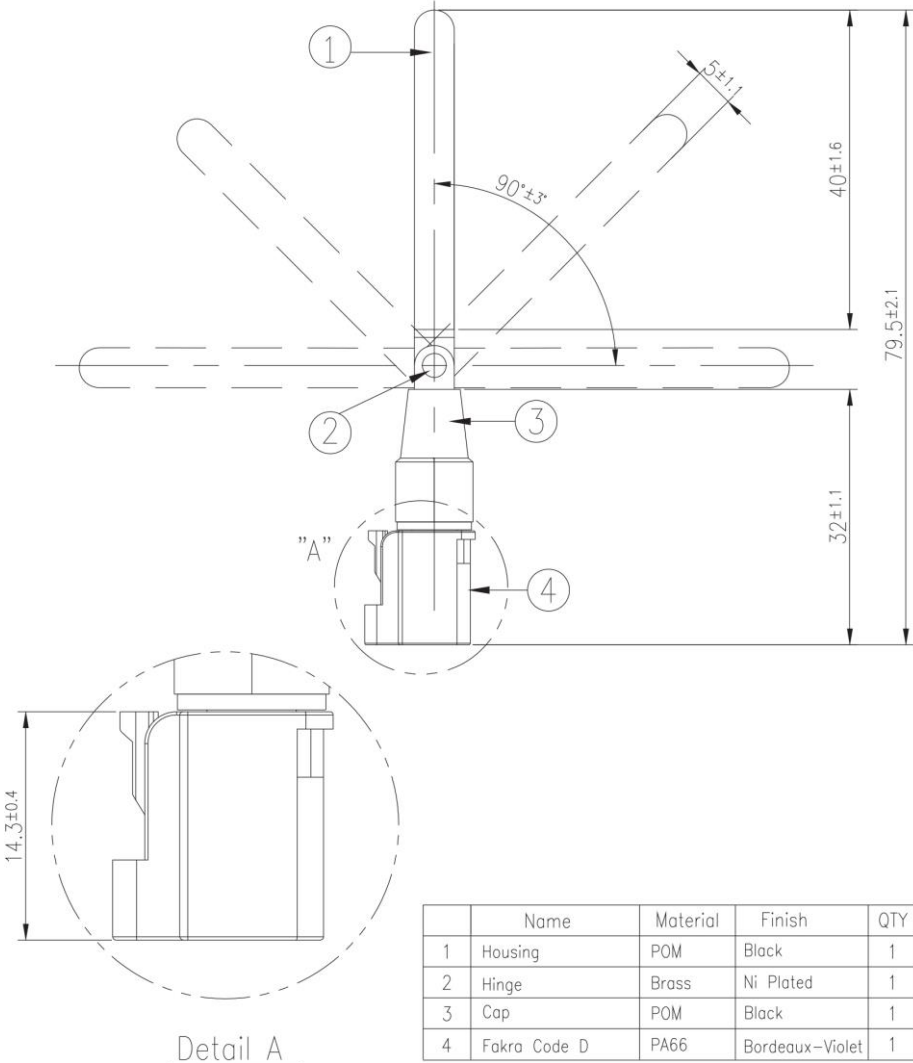

4. Packaging

1 pcs TG.08.0723 per PE bag
 PE Bag Dimensions - 52 x 86mm
 Weight - 8.5g

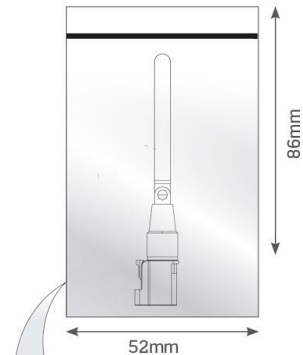

100 PE bags per large PE bags
 100 pcs TG.08.0723 per large PE bags
 Large PE bags Dimensions - 280 x 180mm
 Weight - 0.9Kg

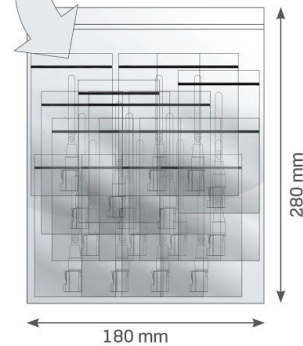

10 Large PE bags per carton
 1000 pcs TG.08.0723 per carton
 Carton Dimensions - 360 x 310 x 160mm
 Weight - 9.5Kg

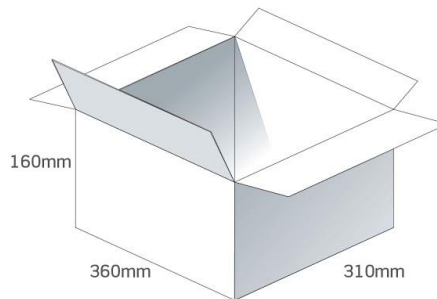

Pallet Dimensions 1200*1000*1480mm
 72 Cartons per Pallet
 9 Cartons per layer
 8 Layers

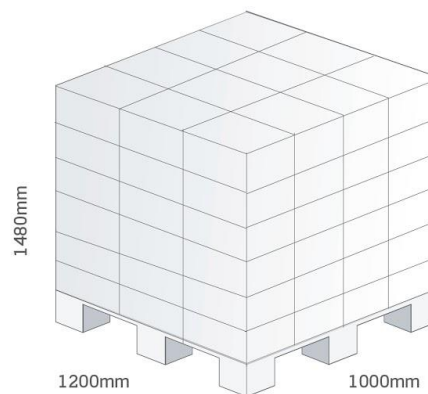

Taoglas makes no warranties based on the accuracy or completeness of the contents of this document and reserves the right to make changes to specifications and product descriptions at any time without notice. Taoglas reserves all rights to this document and the information contained herein.

Reproduction, use or disclosure to third parties without express permission is strictly prohibited.

Copyright © Taoglas Ltd.