

NO.	MASSE / DIMENSION
A	1-20UNEF-2A
B	14.2
C	3.2
D	25.1
E	22.2
F	24.6
G	32.5
H	3.1

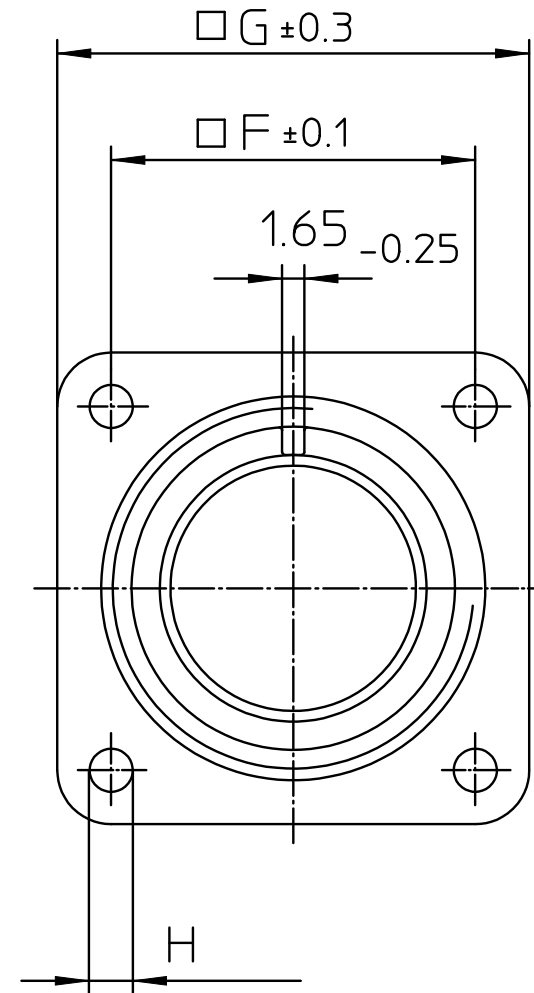

NO.	BESCHREIBUNG / DESCRIPTION
2	ISOLIERKÖRPER BUCHSE / INSULATOR SOCKET
6	KONTAKTBUCHSE / CONTACT SOCKET
8	DOSENGEHÄUSE / SHELL

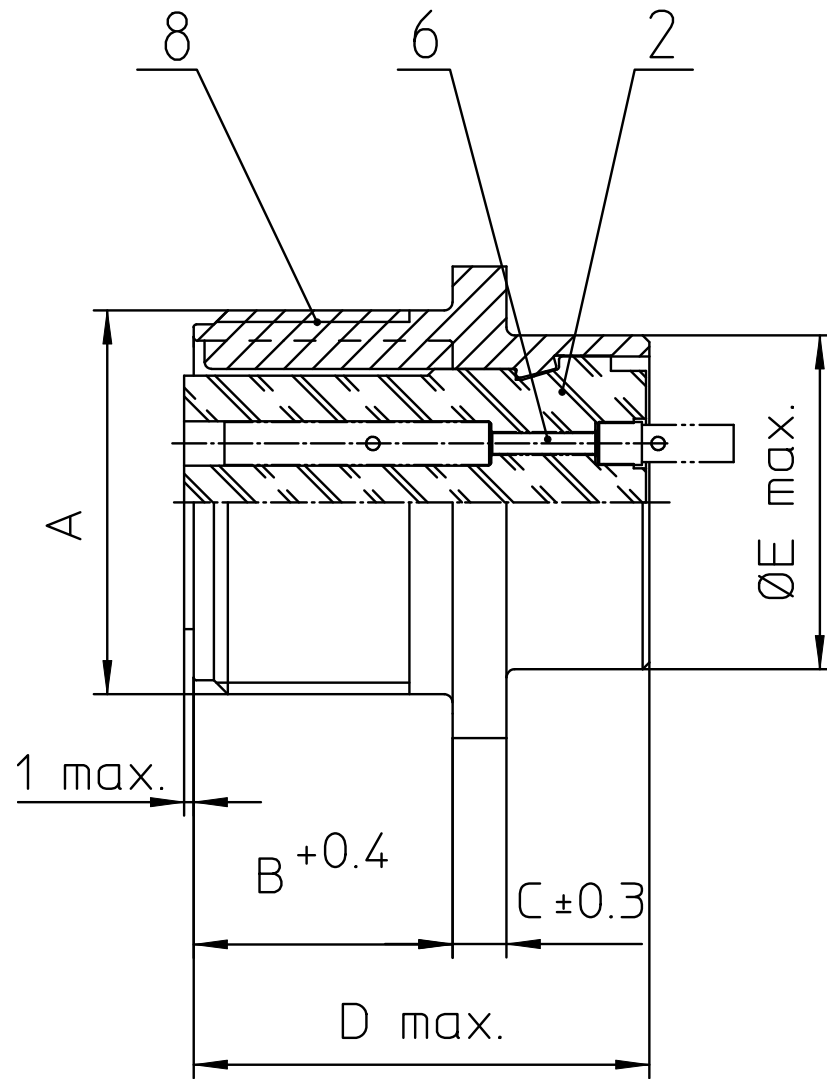
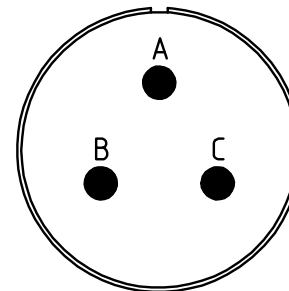

Note: Due to an automatic nomenclature system, numbers generated may not be sequential.
 Specification and Dimensions subject to change
 Drawings illustrate normal insulator positioning

Material Specification:	
Shell Material:	Aluminium alloy
Shell Plating:	Olive drab chromate coating over cadmium plating
Insulator Material:	Neoprene
Contact Material:	Copper alloy
Contact Plating:	Hard silver

all dimensions are in mm Dimensions without tolerance indications are general tolerances in acc. with DIN7168m		drawing for CUSTOMER	
 ITT <i>Engineered for life</i> <small>ITT CANNON GmbH D - 71384 Weinstadt/Germany</small>	description CA3102E16S-5S Box mounting receptacle		
	Solder Cup / Socket / Layout: 16S-5		
© All rights reserved. Reproduction or issue to third in any form whenever is only permitted with written authorization of ITT Cannon		page 1/1	revision 929 11. Jun 19