

NOTES:

1. ROHS COMPLIANT
2. HEADER: THERMOSET PLASTIC MATERIAL WITH FLAMMABILITY RATING UL 94V-0 OR BETTER.
3. STORAGE TEMPERATURE: -20°C TO +125°C
4. COMPLIANCE TO J-STD:
 - A. J-STD-002: SOLDERABILITY AT 245°C REFLOW PROFILE
 - B. J-STD-020: LEVEL 1, NO MOISTURE SENSITIVE
 - C. J-STD-075: R7, 245°C MAXIMUM THROUGH REFLOW SOLDER
5. TO ORDER TAPE & REEL PACKAGING ADD A "T" SUFFIX TO THE PART NUMBER(i.e H1174NL BECOMES H1174NLT).

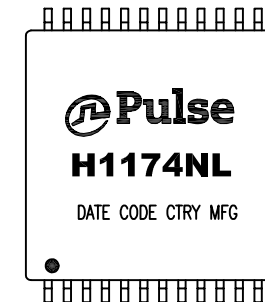

FINAL OUTLINE

© Copyright, 2015. Pulse Electronics Corp. All rights reserved. Pulse confidential & proprietary. (07/31/15)

PRODUCT DESCRIPTION	TLA DRAWING	PS DRAWING	SHEET	PART NO.	DATASHEET REV.
MDL,DUAL,100D,1:1,SM,TU	H1174NL-12	PS-0047.001-B	1 OF 3	H1174NL	A

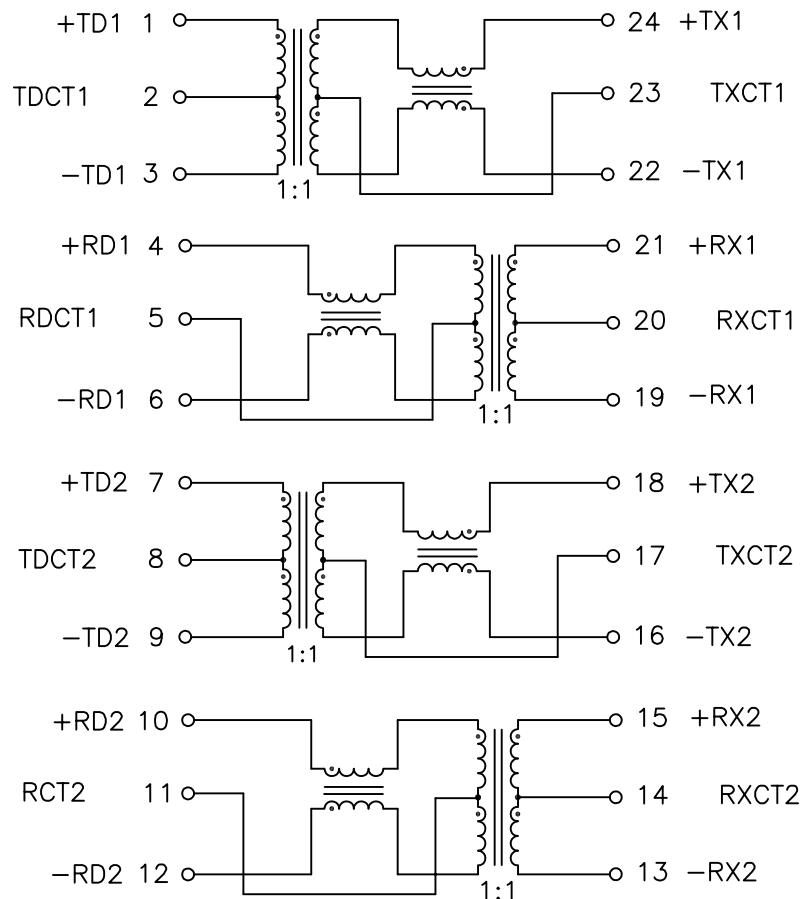

SCHEMATIC

ELECTRICAL CHARACTERISTICS AT +25°C UNLESS OTHER SPECIFIED
MEETS IEEE 802.3 SPECIFICATION

PARAMETER	SPECIFICATIONS	
OPERATING TEMP	0°C - 70 °C	
TURNS RATIO	1 : 1 ±2%	
POLARITY	PER SCHEMATIC	
INSERTION LOSS	1-100 MHz	125 MHz
	-1.0 dB MAX	-1.2 dB MAX
RETURN LOSS $Z_{OUT} = 100 \text{ OHMS}$	1 MHz	30-80 MHz
	-20 dB MIN	$-18 + 26 \text{ LOG}_{10}(f/30 \text{ MHz}) \text{ dB MIN}$
CROSSTALK (TX-RX)	5-100 MHz	
	$-50 + 12 \text{ LOG}_{10}(f/5 \text{ MHz}) \text{ dB MIN}$	
DIFFERENTIAL TO COMMON MODE REJECTION	5-200 MHz	
	$-50 + 17 \text{ LOG}_{10}(f/5 \text{ MHz}) \text{ dB MIN}$	
COMMON MODE REJECTION	$-50 + 17 \text{ LOG}_{10}(f/5 \text{ MHz}) \text{ dB MIN}$	
ISOLATION (INPUT - OUTPUT)	1500 VRMS 1 MINUTE	

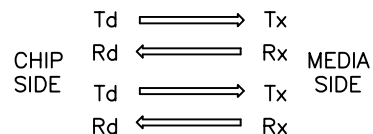

© Copyright, 2015. Pulse Electronics Corp. All rights reserved. Pulse confidential & proprietary. (07/31/15)

PRODUCT DESCRIPTION	TLA DRAWING	PS DRAWING	SHEET	PART NO.	DATASHEET REV.
MDL,DUAL,100D,1:1,SM,TU	H1174NL-12	PS-0047.001-B	2 OF 3	H1174NL	A

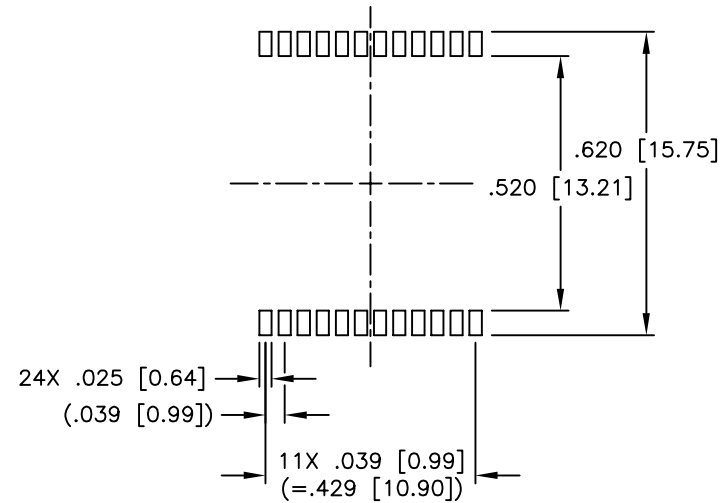
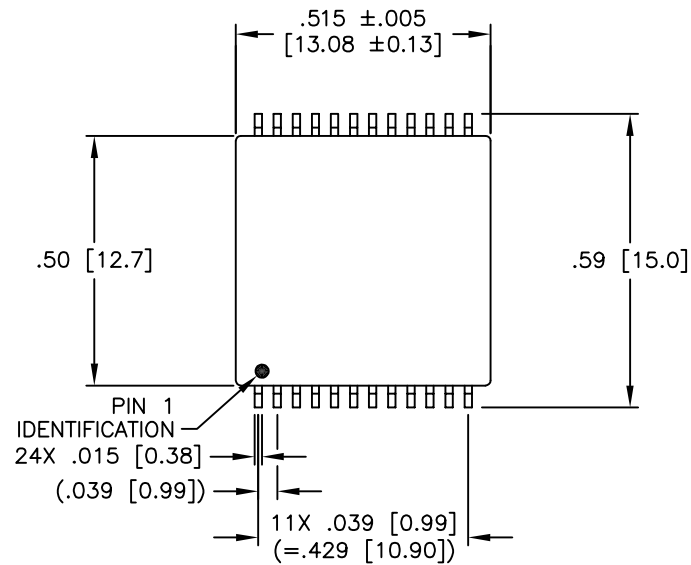

SUGGESTED LAND PATTERN

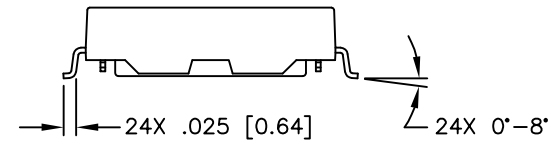
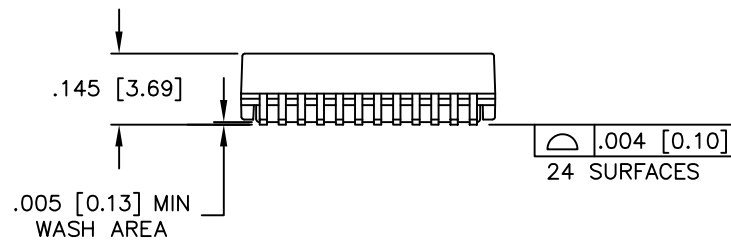

DIMENSIONS ARE IN INCHES [MILLIMETERS] WITH THE FOLLOWING TOLERANCES: [MILLIMETERS] ARE FOR REFERENCE ONLY.
.XX = $\pm .02$ [± 0.5]
.XXX = $\pm .010$ [± 0.25]

© Copyright, 2015. Pulse Electronics Corp. All rights reserved. Pulse confidential & proprietary. (07/31/15)

PRODUCT DESCRIPTION	TLA DRAWING	PS DRAWING	SHEET	PART NO.	DATASHEET REV.
MDL,DUAL,100D,1:1,SM,TU	H1174NL-12	PS-0047.001-B	3 OF 3	H1174NL	A