

Data sheet | Item number: 870-523/281-587

Component terminal block; double-deck; with varistor; for DIN-rail 35 x 15 and 35 x 7.5; 2.5 mm²; CAGE CLAMP®; 2,50 mm²; gray

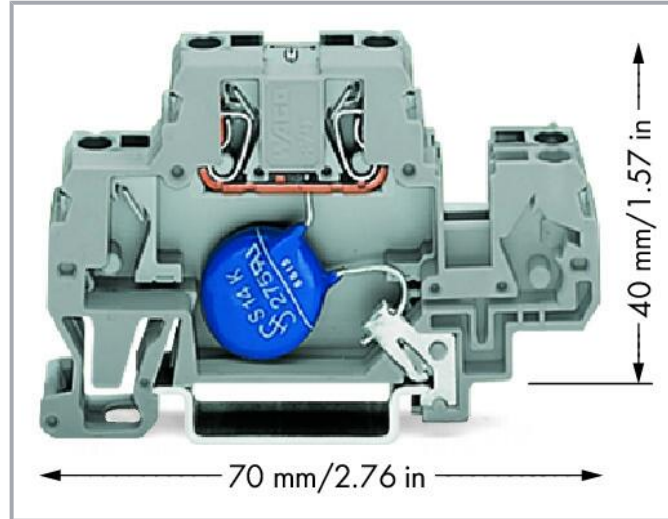

www.wago.com/870-523/281-587

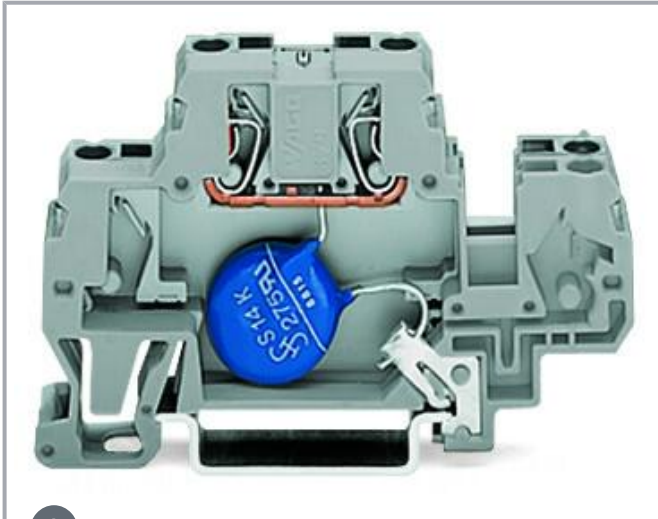

i Picture differs from the item.

Color: —

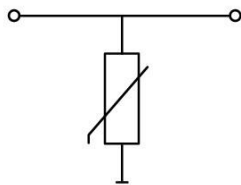

Data

Electrical data

Nominal operating voltage	AC 115 V
Highest continuous voltage	AC 150 V
Rated continuous current	20 A
Nominal discharge current (8/20 μs) (line)	1 kA
Discharge current (max.)	4.5 kA
Protection level (8/20 μs)	≤ AC 395 V

Subject to changes. Please also observe the further product documentation!

WAGO GmbH & Co. KG
Hansastr. 27
32423 Minden
Phone: +49571 887-0 | Fax: +49571 887-169
Email: info.de@wago.com | Web: www.wago.com

Do you have any questions about our products?
We are always happy to take your call at +49 (571) 887-44222.



Capacitance	≤ 570 pF
-------------	----------

Connection data

Connections (number)	2
Connection technology	CAGE CLAMP®
Solid conductor	0.08 ... 2.5 mm ² / 28 ... 14 AWG
Fine-stranded conductor	0.08 ... 4 mm ² / 28 ... 12 AWG
Fine-stranded conductor; with insulated ferrule	0.08 ... 1.5 mm ² / 28 ... 14 AWG
Strip length	6 ... 7 mm / 0.24 ... 0.28 inches

Physical data

Width	10 mm / 0.394 inches
Height from upper-edge of DIN-rail	40 mm / 1.575 inches
Depth	70 mm / 2.756 inches

Mechanical Data

Mounting type	DIN-35 rail
---------------	-------------

Material Data

Color	gray
Insulation material	Polyamide (PA66)
Material group	I
Flammability class per UL94	V0
Fire load	0.257 MJ
Weight	12.2 g

Environmental requirements

Processing temperature	-35 ... +85 °C
------------------------	----------------

Commercial data

Product Group	16 (Rail Mounted Terminal Blocks with CCC)
eCl@ss 10.0	27-14-11-27
eCl@ss 9.0	27-14-11-27
ETIM 8.0	EC000903
ETIM 7.0	EC000903

Subject to changes. Please also observe the further product documentation!



PU (SPU)	25 pcs
Packaging type	box
Country of origin	DE
GTIN	4045454353698
Customs tariff number	85369010000

Environmental Product Compliance

RoHS Compliance Status	Compliant, No Exemption
------------------------	-------------------------

Optional accessories



Insulation stop

Insulation stop		
	Item no.: 280-472 Insulation stop; 0.75 - 1 mm ² ; 5 pieces/strip; black	www.wago.com/280-472
	Item no.: 280-470 Insulation stop; 0.08 - 0.2 mm ² "s" (0.14 mm ² "f-st"); 5 pieces/strip; white	www.wago.com/280-470
	Item no.: 280-471 Insulation stop; 0.25 - 0.5 mm ² ; 5 pieces/strip; light gray	www.wago.com/280-471



Jumpers

Jumper		
	Item no.: 280-492 Jumper; 2-way; insulated; gray	www.wago.com/280-492

Marking accessories

Marker		
	Item no.: 2009-145 Mini-WSB Inline; for Smart Printer; 1700 pieces on roll; stretchable 5 - 5.2 mm; plain; snap-on type; white	www.wago.com/2009-145
	Item no.: 248-501 Mini-WSB marking card; as card; not stretchable; plain; snap-on type; white	www.wago.com/248-501

End plate

End plate		
	Item no.: 870-518 End and intermediate plate; 2 mm thick; gray	www.wago.com/870-518
	Item no.: 870-519 End and intermediate plate; 2 mm thick; orange	www.wago.com/870-519

Tool

Subject to changes. Please also observe the further product documentation!

Operating tool



Item no.: 210-720

Operating tool; Blade: 3.5 x 0.5 mm; with a partially insulated shaft; multicoloured

www.wago.com/210-720

Downloads

Documentation

Bid Text

870-523/281-587 X81 - Datei	2019 Feb 19	xml 3.5 kB	Download
--------------------------------	-------------	---------------	----------

870-523/281-587 doc - Datei	2015 Feb 11	doc 26.6 kB	Download
--------------------------------	-------------	----------------	----------

Additional Information

Disposal and Recycling Electrical and electronic equipment, Batteries, Packaging	V 1.1.0 2022 Aug 18	pdf 2.2 MB	Download
-------------------------------------------------------------------------------------	------------------------	---------------	----------

CAD/CAE-Data

CAD data

2D/3D Models 870-523/281-587	URL	Download
------------------------------	-----	----------

CAE data

EPLAN Data Portal 870-523/281-587	URL	Download
-----------------------------------	-----	----------

WSCAD Universe 870-523/281-587	URL	Download
--------------------------------	-----	----------

ZUKEN Portal 870-523/281-587	URL	Download
------------------------------	-----	----------

WSCAD Universe 870-523/281-587	URL	Download
--------------------------------	-----	----------

EPLAN Data Portal 870-523/281-587	URL	Download
-----------------------------------	-----	----------

Environmental Product Compliance

Compliance Search

Subject to changes. Please also observe the further product documentation!

WAGO GmbH & Co. KG
 Hansastr. 27
 32423 Minden
 Phone: +49571 887-0 | Fax: +49571 887-169
 Email: info.de@wago.com | Web: www.wago.com

Do you have any questions about our products?
 We are always happy to take your call at +49 (571) 887-44222.

Data sheet | Item number: 870-523/281-587

www.wago.com/870-523/281-587



Environmental Product Compliance 870-523/281-587

URL

Download

Component terminal block; double-deck; with varistor; for DIN-rail 35 x 15 and 35 x 7.5; 2.5 mm²; CAGE CLAMP®; 2,50 mm²; gray

Installation Notes

Subject to changes. Please also observe the further product documentation!

WAGO GmbH & Co. KG

Hansastr. 27

32423 Minden

Phone: +49571 887-0 | Fax: +49571 887-169

Email: info.de@wago.com | Web: www.wago.com

Do you have any questions about our products?

We are always happy to take your call at +49 (571) 887-44222.