

Sensor/actuator cable - SAC-4P-MR/ 2,0-542 SH SCO BK - 1406186

Please be informed that the data shown in this PDF Document is generated from our Online Catalog. Please find the complete data in the user's documentation. Our General Terms of Use for Downloads are valid (<http://phoenixcontact.com/download>)



Sensor/actuator cable, 4-position, PVC, yellow, shielded, Plug angled M12 SPEEDCON, A-coded, on free cable end, cable length: 2 m



Key Commercial Data

Packing unit	1 pc
Minimum order quantity	50 pc
GTIN	 4 046356 798648
GTIN	4046356798648

Technical data

Dimensions

Length of cable	2 m
-----------------	-----

Ambient conditions

Ambient temperature (operation)	-25 °C ... 90 °C (Plug / socket)
Degree of protection	IP65/IP67

General

Rated current at 40°C	4 A
Rated voltage	48 V AC 60 V DC
Number of positions	4
Insulation resistance	≥ 10 MΩ
Coding	A - standard
Standards/regulations	M12 connector IEC 61076-2-101
Status display	No
Protective circuit/component	unwired
Overvoltage category	II
Degree of pollution	3

Sensor/actuator cable - SAC-4P-MR/ 2,0-542 SH SCO BK - 1406186

Technical data

General

Insertion/withdrawal cycles	≥ 100
Torque	0.4 Nm (M12 connector)

Material

Flammability rating according to UL 94	HB
Contact material	CuSn
Contact surface material	Ni/Au
Contact carrier material	TPU GF
Material of grip body	TPU, hardly inflammable, self-extinguishing
Material, knurls	Zinc die-cast, nickel-plated

Standards and Regulations

Standard designation	M12 connector
Standards/regulations	IEC 61076-2-101
Flammability rating according to UL 94	HB

Cable

Cable type	PVC yellow 105 °C
Cable type (abbreviation)	542
UL AWM style	2517 (105 °C / 300 V)
AWG signal line	22
Conductor structure signal line	30x 1.30 mm
Core diameter including insulation	1.27 mm ±0.03 mm
Wire colors	brown, blue, black, white
Overall twist	4 wires, twisted
Shielding	Tinned copper braided shield
Optical shield covering	85 %
External sheath, color	yellow
External cable diameter D	5.5 mm ±0.2 mm
Minimum bending radius, flexible installation	12 x D
Cable weight	48 kg/km
Outer sheath, material	PVC
Material conductor insulation	PVC
Conductor material	Tin-plated Cu litz wires
Insulation resistance	≥ (550 M Ohms/m @ 500V)
Conductor resistance	max. 50.5 Ω/km (20 °C)
Nominal voltage, cable	300 V
Special properties	UL standards PLTC and ITC
Flame resistance	FT4
Other resistance	UV resistant
Ambient temperature (operation)	-30 °C ... 105 °C (cable, fixed installation)
	-5 °C ... 105 °C (cable, flexible installation)

Sensor/actuator cable - SAC-4P-MR/ 2,0-542 SH SCO BK - 1406186

Technical data

Environmental Product Compliance

China RoHS	Environmentally friendly use period: unlimited = EFUP-e
	No hazardous substances above threshold values

Drawings

Dimensional drawing

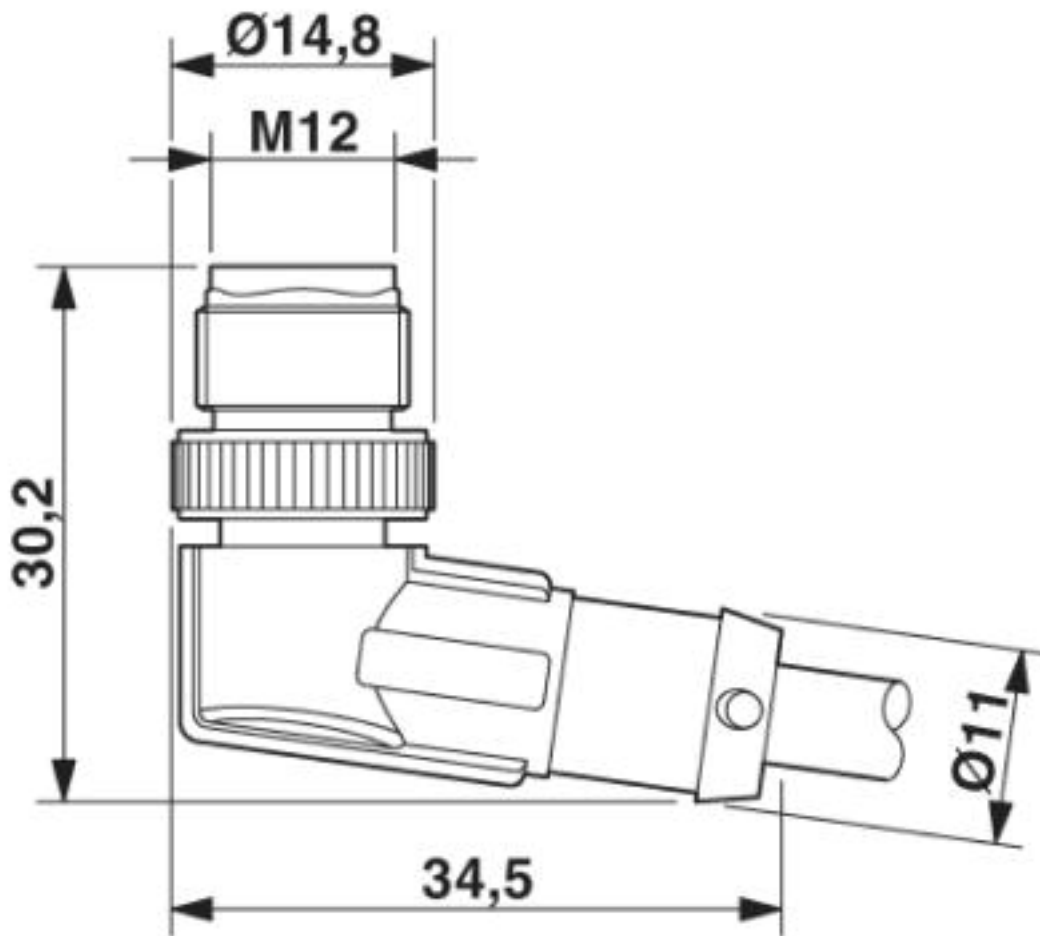

M12 x 1 male plug, angled

Sensor/actuator cable - SAC-4P-MR/ 2,0-542 SH SCO BK - 1406186

Circuit diagram

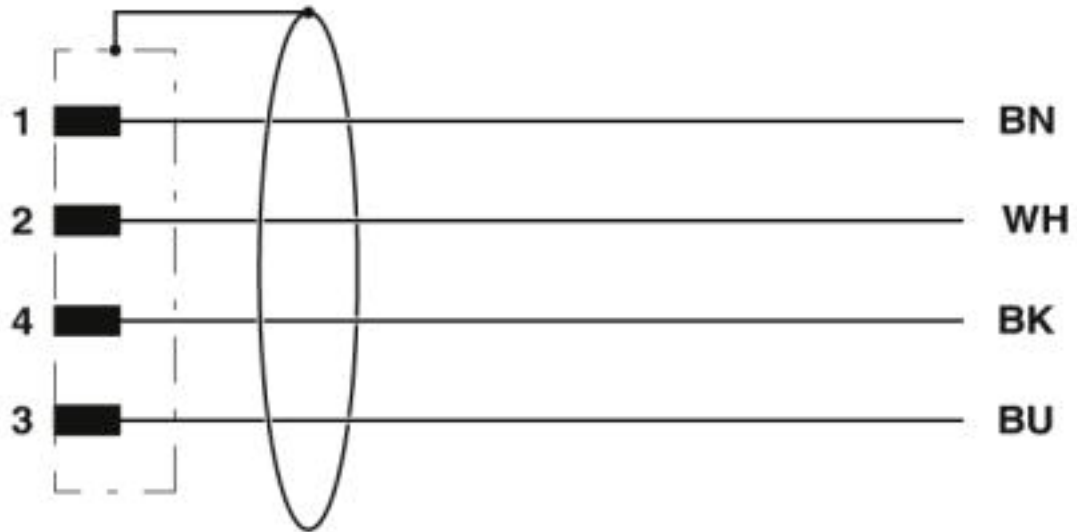

Contact assignment of the M12 plugs

Sensor/actuator cable - SAC-4P-MR/ 2,0-542 SH SCO BK - 1406186

Schematic diagram



Pin assignment M12 plug, 4-pos., A-coded, view plug side

Sensor/actuator cable - SAC-4P-MR/ 2,0-542 SH SCO BK - 1406186

Cable cross section

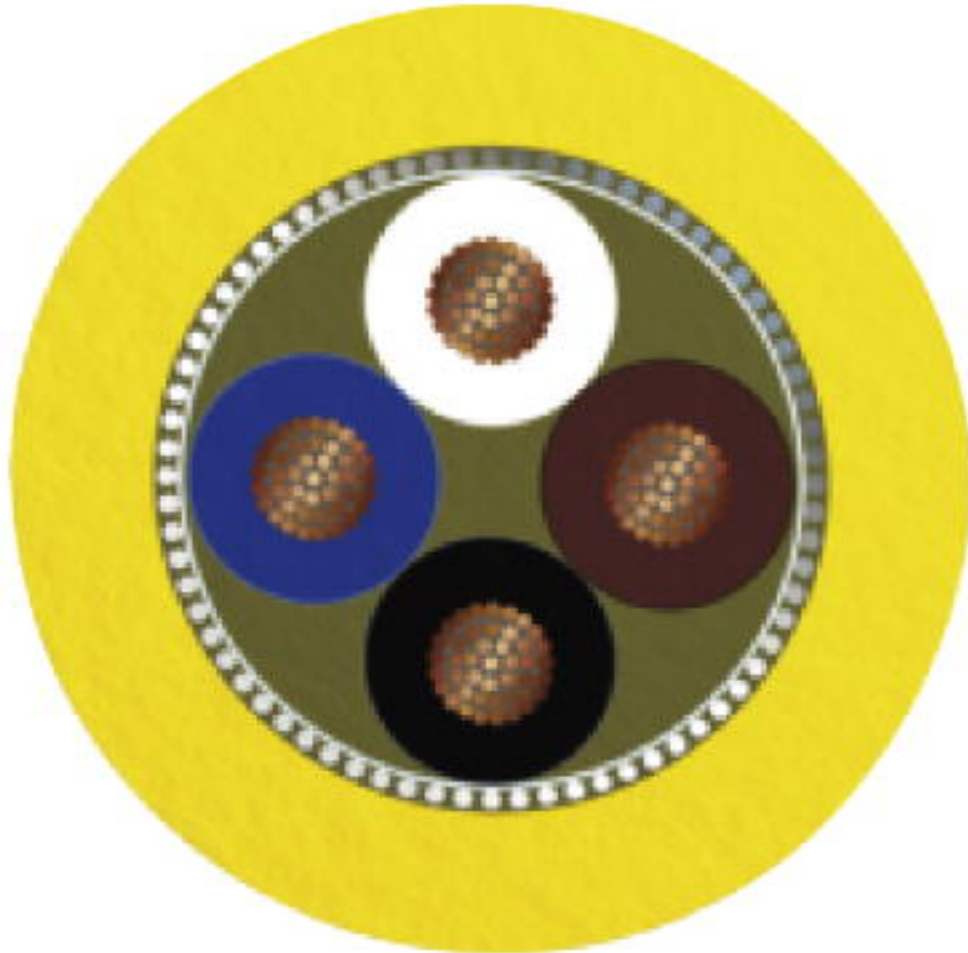

PVC yellow 105 °C [542]

Approvals

Approvals

Approvals

UL Listed / cUL Listed / EAC / cULus Listed

Ex Approvals

Approval details

Sensor/actuator cable - SAC-4P-MR/ 2,0-542 SH SCO BK - 1406186

Approvals

UL Listed		http://database.ul.com/cgi-bin/XYV/template/LISEXT/1FRAME/index.htm	FILE E 221474
Nominal voltage UN		300 V	
Nominal current IN		4 A	

cUL Listed		http://database.ul.com/cgi-bin/XYV/template/LISEXT/1FRAME/index.htm	FILE E 221474
Nominal voltage UN		300 V	
Nominal current IN		4 A	

EAC		RU C- DE.BL08.B.00286
-----	--	--------------------------

cULus Listed	
--------------	---

Phoenix Contact 2019 © - all rights reserved
<http://www.phoenixcontact.com>

PHOENIX CONTACT GmbH & Co. KG
 Flachsmarktstr. 8
 32825 Blomberg
 Germany
 Tel. +49 5235 300
 Fax +49 5235 3 41200
<http://www.phoenixcontact.com>