

THIS DRAWING CONTAINS INFORMATION PROPRIETARY TO POSITRONIC AND ITS SUBSIDIARIES. POSITRONIC BELIEVES THE DATA ON THIS DRAWING TO BE RELIABLE. SINCE THE TECHNICAL INFORMATION IS GIVEN FREE OF CHARGE, THE USER EMPLOYS SUCH INFORMATION AT HIS OWN DISCRETION AND RISK. POSITRONIC ASSUMES NO RESPONSIBILITY FOR RESULTS OBTAINED OR DAMAGES INCURRED FROM USE OF SUCH INFORMATION IN WHOLE OR IN PART.

DATE	REV	REVISION RECORD	APP	DR	CK
11-2-11	NC	ECO 34662	COLE	BE	COLE
8-12-13	A	ECO 40371	COLE	BE	COLE

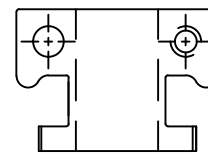

2X

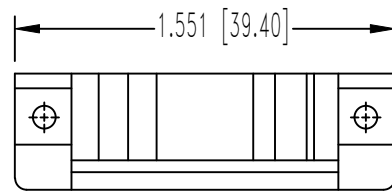
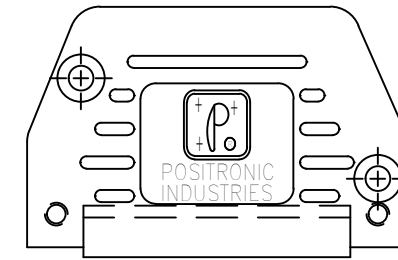
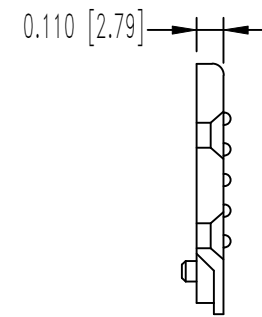
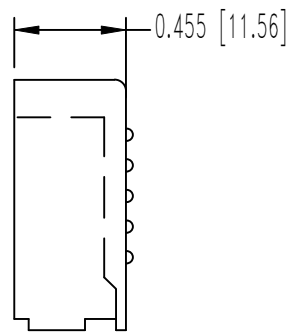
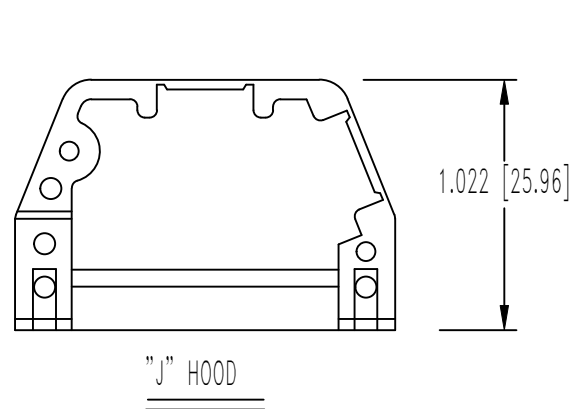
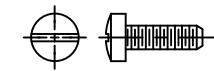

CABLE CLAMP SCREW

2X

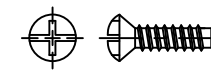

COVER SCREW

2X

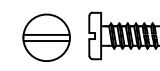

MOUNTING SCREW

2X

NOTES:

- MATERIALS AND FINISHES:
 HOOD AND HOOD COVER: GLASS-FILLED POLYESTER, 94V-0, COLOR BLACK.
 CABLE CLAMP: STEEL, NICKEL PLATE.
 CABLE CLAMP SCREW: BRASS, ZINC PLATE WITH CHROMATE SEAL.
 SCREWS: STEEL, ZINC PLATE WITH CHROMATE SEAL.
- DETAILED PRODUCT, ELECTRICAL, AND MECHANICAL INFORMATION IS AVAILABLE IN THE LATEST D-SUBMINIATURE ACCESSORIES PRODUCT PUBLICATION. VISIT CONNECTPOSITRONIC.COM/PRODUCTS/58/D-SUBMINIATUREACCESSORIES OR CONNECTPOSITRONIC.COM.
- ACCESSORY IS COMPLIANT TO THE CURRENT ROHS DIRECTIVE.
- DIMENSIONS ARE IN INCHES[MILLIMETERS].

	POSITRONIC INDUSTRIES INC. www.connectpositronic.com		FSCM 28198
	SCALE N.T.S.	DRAWN BY B. EVANS	APPROVED BY COLE
DECIMAL TOL. ± 0.015 [0.38]	D SERIES		
ANGULAR TOL. ± 5°	TITLE D15000J00/AA		
DATE 11-2-11	DRAWING NUMBER SK12920	REV. A	