

## Datasheet

### Retroreflective Array Sensor Error Proofing and Light-Guided Assembly



- Rugged metal frame with 225 mm (8.9 in) or 500 mm (19.7 in) sensing length; 1.5 m (4.9 ft) sensing range using included retroreflective tape (up to 6 m (20 ft) range when used with multiple BRT-84X84A retroreflectors)
- Highly visible green pick arrow
- Red mis-pick arrow
- Flexible mounting options; rugged steel mounting brackets
- Fast response time—excellent for part detection applications



#### WARNING: Not To Be Used for Personnel Protection

**Never use this device as a sensing device for personnel protection. Doing so could lead to serious injury or death.** This device does not include the self-checking redundant circuitry necessary to allow its use in personnel safety applications. A sensor failure or malfunction can cause either an energized or de-energized sensor output condition.

## Models

Model Number	Description	Cable	Output <sup>1</sup>
PVL225P	225 mm (8.9 in) length, with up to 1.5 m (4.9 ft) separation between sensor and retroreflective tape (included)	2 m (6.5 ft), 4 wire unterminated cable	PNP, NC
PVL225N			NPN, NC
PVL225PQ		2 m (6.5 ft), cable terminated in 12 mm QD	PNP, NC
PVL225NQ			NPN, NC
PVL500P	500 mm (19.7 in) length with up to 1.5 m (4.9 ft) separation between sensor and retroreflective tape (included)	2 m (6.5 ft), 4 wire unterminated cable	PNP, NC
PVL500N			NPN, NC
PVL500PQ		2 m (6.5 ft), cable terminated in 12 mm QD	PNP, NC
PVL500NQ			NPN, NC

## Installation

Multiple sensors located farther than the sensor's maximum range from one another are unlikely to cause crosstalk problems. However, when multiple sensors are mounted in a confined area, take care to avoid crosstalk between them. Make sure that the sensor's beams fall in the center of the reflector.

**Correct Alignment**

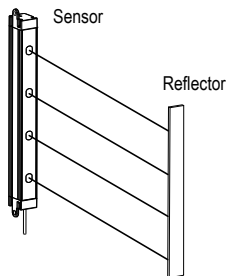

**Incorrect Alignment**

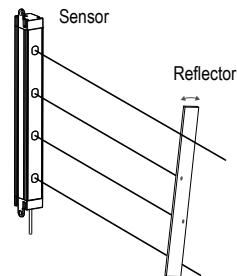

<sup>1</sup> NC = normally closed



## Wiring Diagram

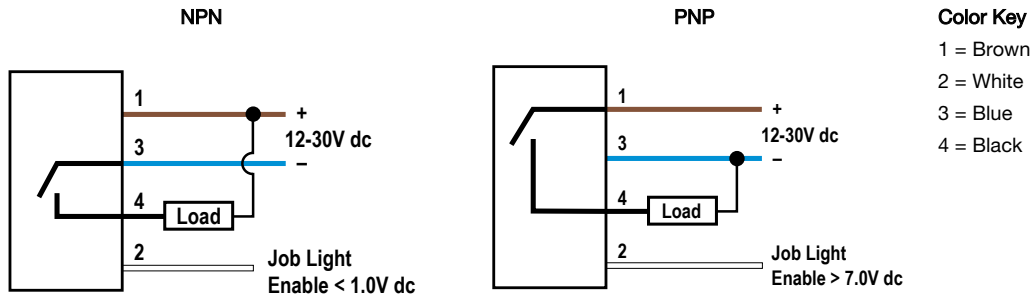

**Note:** Pin 5 (center) is not used.

## Status Indicators/Troubleshooting

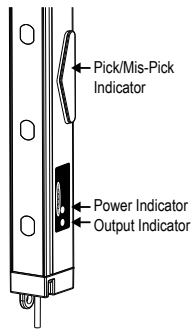

Target *	Job Enable (white wire)	Pick/Mis-pick Indicator	Power Indicator	Output Indicator	Output
Not sensed	inactive	off	green	off	inactive
Sensed	inactive	flashing red	green	amber	active
Not sensed	active	green	green	off	inactive
Sensed	active	green	green	amber	active

Target not sensed = All beams are unbroken.

Target sensed = One or more beams are broken.

## Specifications

### Supply Voltage

12 V dc to 30 V dc

### Supply Current

#### PVL225:

< 140 mA max current at 12 V dc (exclusive of load)

< 70 mA max current at 30 V dc (exclusive of load)

#### PVL500:

< 220 mA max current at 12 V dc (exclusive of load)

< 100 mA max current at 30 V dc (exclusive of load)

### Supply Protection Circuitry

Protected against reverse polarity and transient voltages

### Output Rating

**Maximum Load:** 150 mA

**ON-state saturation voltage:**

PNP: < 2 V dc at 10 mA; < 2.5 V dc at 150 mA

NPN: < 1.5 V dc at 10 mA; < 2.0 V dc at 150 mA

**OFF-state leakage current:** < 10 µA at 30 V dc

### Indicators

Job (pick) indicator: green  
 Misspick indicator: flashing red  
 Green LED: Power ON/OFF  
 Amber LED: Output ON/OFF

### Output Response Time

Less than 2 milliseconds ON and OFF

### Beam Spacing

70 mm

PVL225: 4 beams

PVL500: 8 beams

### Sensing Range

1.5 m (4.9 ft) with retroreflective tape

### Connections

2m (6.5 ft) PVC integral cable with unterminated, or 2m (6.5 ft) cable with 12 mm QD

### Minimum Object Detection Size

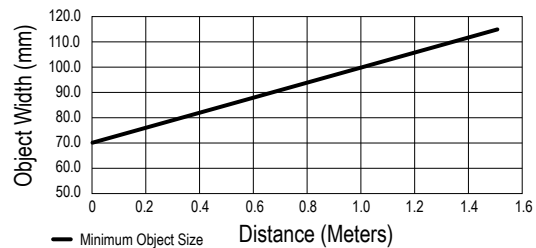

### Environmental Rating

IEC IP50

### Operating Conditions

0 °C to +50 °C (+32 °F to +122 °F)

90% at 50 °C maximum relative humidity (non-condensing)

Storage: -40 °C to +70 °C (-40 °F to +158 °F)

### Construction

Aluminum anodized housing; polycarbonate translucent dome

### Vibration and Mechanical Shock

All models meet Mil. Std. 202F requirements method 201A (vibration: 10 Hz to 60 Hz max., double amplitude 0.06 in. maximum acceleration 10G). Also meets IEC 947-5-2; 30G 11 ms duration, half sine wave.

### Certifications



## Dimensions

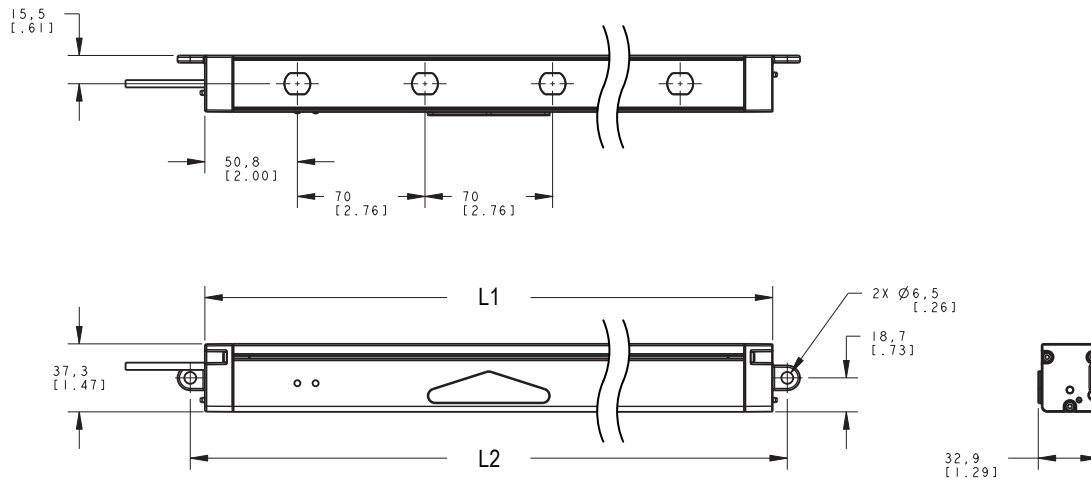

Model	L1	L2
PVL225	311.5 mm (12.26 in)	327.5 mm (12.89 in)
PVL500	592 mm (23.31 in)	608 mm (23.94 in)

## Accessories

### Cordsets

4-Pin Threaded M12/Euro-Style Cordsets				
Model	Length	Style	Dimensions	Pinout (Female)
MQDC-406	1.83 m (6 ft)	Straight		<p>1 = Brown 2 = White 3 = Blue 4 = Black</p>
MQDC-415	4.57 m (15 ft)			
MQDC-430	9.14 m (30 ft)			
MQDC-450	15.2 m (50 ft)	Right-Angle		
MQDC-406RA	1.83 m (6 ft)			
MQDC-415RA	4.57 m (15 ft)			
MQDC-430RA	9.14 m (30 ft)			
MQDC-450RA	15.2 m (50 ft)			

### Mounting Brackets

#### SMBPVL1

- Right-angle bracket for mounting the pick-to-light array
- 7 mm mounting hole
- 14 gauge cold rolled steel

A =  $\phi$  3, B =  $\phi$  7, C =  $\phi$  4.8

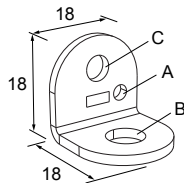

#### SMBPVL2-225

- Flat bracket for mounting reflector inside bin
- 7 mm mounting hole
- 14 gauge cold rolled steel
- Includes retroreflective tape

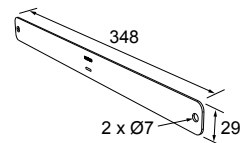

**SMBPVL2-500**

- Flat bracket for mounting reflector inside bin
- 7 mm mounting hole
- 14 gauge cold rolled steel
- Includes retroreflective tape

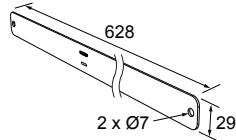

**SMBPVL3-225**

- Right-angle bracket for mounting reflector outside bin
- 7 mm mounting hole
- 14 gauge cold rolled steel
- Includes retroreflective tape

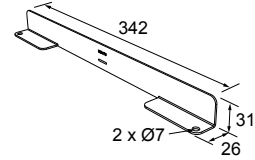

**SMBPVL3-500**

- Right-angle bracket for mounting reflector outside bin
- 7 mm mounting hole
- 14 gauge cold rolled steel
- Includes retroreflective tape

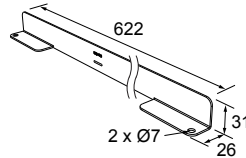

**SMBPVL4**

- 28 mm tubular mount bracket for mounting outside bin
- Clearance for M6 (1/4 in) hardware
- Painted cold rolled steel

A =  $\varnothing$  M6 x 1, B =  $\varnothing$  M6 x 1, C =  $\varnothing$  28

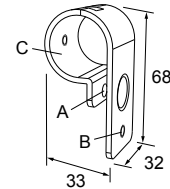

**SMBPVL5**

- 28 mm tubular mount bracket for mounting inside bin
- Clearance for M6 (1/4 in) hardware
- Painted cold rolled steel

A =  $\varnothing$  M6 x 1 ISO 6H

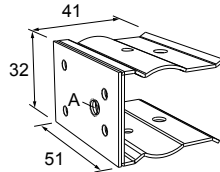

Retroreflectors

Model	Reflectivity Factor	Range	Size
<b>Replacement Tape</b> BRT-THG-1-100	0.7	1.5 m (4.9 ft)	25 mm (1 in) wide 2.5 m (8.2 ft) long
<b>Long Range Reflectors</b> BRT-84X84A	2.0	6 m (19.7 ft)	84x84 mm

Banner Engineering Corp. Limited Warranty

Banner Engineering Corp. warrants its products to be free from defects in material and workmanship for one year following the date of shipment. Banner Engineering Corp. will repair or replace, free of charge, any product of its manufacture which, at the time it is returned to the factory, is found to have been defective during the warranty period. This warranty does not cover damage or liability for misuse, abuse, or the improper application or installation of the Banner product.

**THIS LIMITED WARRANTY IS EXCLUSIVE AND IN LIEU OF ALL OTHER WARRANTIES WHETHER EXPRESS OR IMPLIED (INCLUDING, WITHOUT LIMITATION, ANY WARRANTY OF MERCHANTABILITY OR FITNESS FOR A PARTICULAR PURPOSE), AND WHETHER ARISING UNDER COURSE OF PERFORMANCE, COURSE OF DEALING OR TRADE USAGE.**

This Warranty is exclusive and limited to repair or, at the discretion of Banner Engineering Corp., replacement. **IN NO EVENT SHALL BANNER ENGINEERING CORP. BE LIABLE TO BUYER OR ANY OTHER PERSON OR ENTITY FOR ANY EXTRA COSTS, EXPENSES, LOSSES, LOSS OF PROFITS, OR ANY INCIDENTAL, CONSEQUENTIAL OR SPECIAL DAMAGES RESULTING FROM ANY PRODUCT DEFECT OR FROM THE USE OR INABILITY TO USE THE PRODUCT, WHETHER ARISING IN CONTRACT OR WARRANTY, STATUTE, TORT, STRICT LIABILITY, NEGLIGENCE, OR OTHERWISE.**

Banner Engineering Corp. reserves the right to change, modify or improve the design of the product without assuming any obligations or liabilities relating to any product previously manufactured by Banner Engineering Corp. Any misuse, abuse, or improper application or installation of this product or use of the product for personal protection applications when the product is identified as not intended for such purposes will void the product warranty. Any modifications to this product without prior express approval by Banner Engineering Corp will void the product warranties. All specifications published in this document are subject to change; Banner reserves the right to modify product specifications or update documentation at any time. Specifications and product information in English supersedes that which is provided in any other language. For the most recent version of any documentation, refer to: [www.bannerengineering.com](http://www.bannerengineering.com).

For patent information, see [www.bannerengineering.com/patents](http://www.bannerengineering.com/patents).