

- NOTES:**
1. MATERIAL:
 - HOUSING: 30% G.F. NYLON 46, UL94V-0,
 - COLOR: BLACK
 - TERMINAL: COPPER ALLOY 0.50mm SQ
 2. PLATING TYPE:
 - (1) GOLD FLASH OVER
50 MICRO INCHES MIN. NICKEL OVERALL.
 - (2) 1 MICRO INCHES MIN. GOLD PLATE ON CONTACT AND
75 MICRO INCHES MIN. TIN ON SOLDER TAIL OVER
50 MICRO INCHES MIN. NICKEL OVERALL.
 - (3) 10 MICRO INCHES MIN. GOLD PLATE ON CONTACT AND
75 MICRO INCHES MIN. TIN ON SOLDER TAIL OVER
50 MICRO INCHES MIN. NICKEL OVERALL.
 - (4) 15 MICRO INCHES MIN. GOLD PLATE ON CONTACT AND
75 MICRO INCHES MIN. TIN ON SOLDER TAIL OVER
50 MICRO INCHES MIN. NICKEL OVERALL.
 - (5) 30 MICRO INCHES MIN. GOLD PLATE ON CONTACT AND
75 MICRO INCHES MIN. TIN ON SOLDER TAIL OVER
50 MICRO INCHES MIN. NICKEL OVERALL.
 - (6) 100 MICRO INCHES MIN. TIN IN SELECTED AREA OVER
50 MICRO INCHES MIN. NICKEL OVERALL.
 3. PIN PUSHOUT FORCE: 1KG MIN IN EITHER DIRECTION
 4. THE ABOVE 14 CKT IS FOR ILLUSTRATION PURPOSE ONLY.
 5. FOR PACKAGING OPTION PLEASE REFER TO THE TABLE.
 6. CAP TO BE PLACED AT APPROXIMATELY CENTRAL OF THE DIM. B

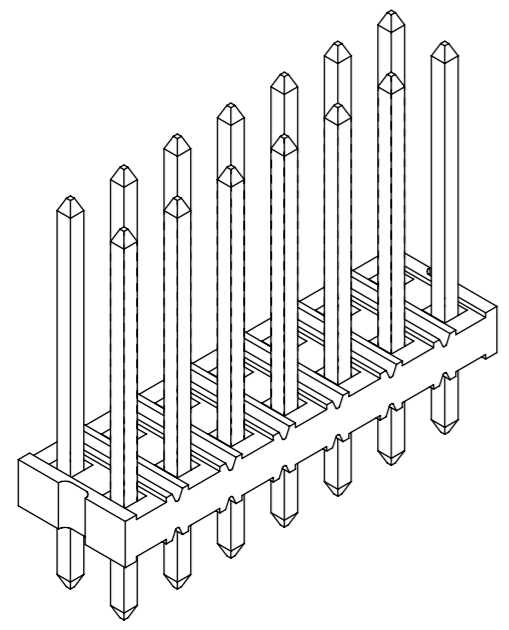
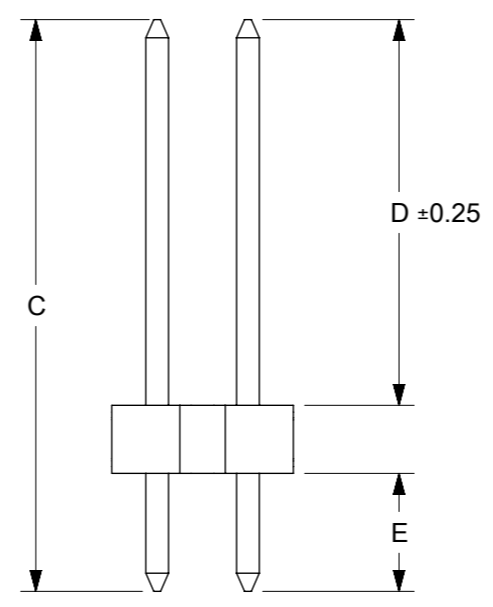
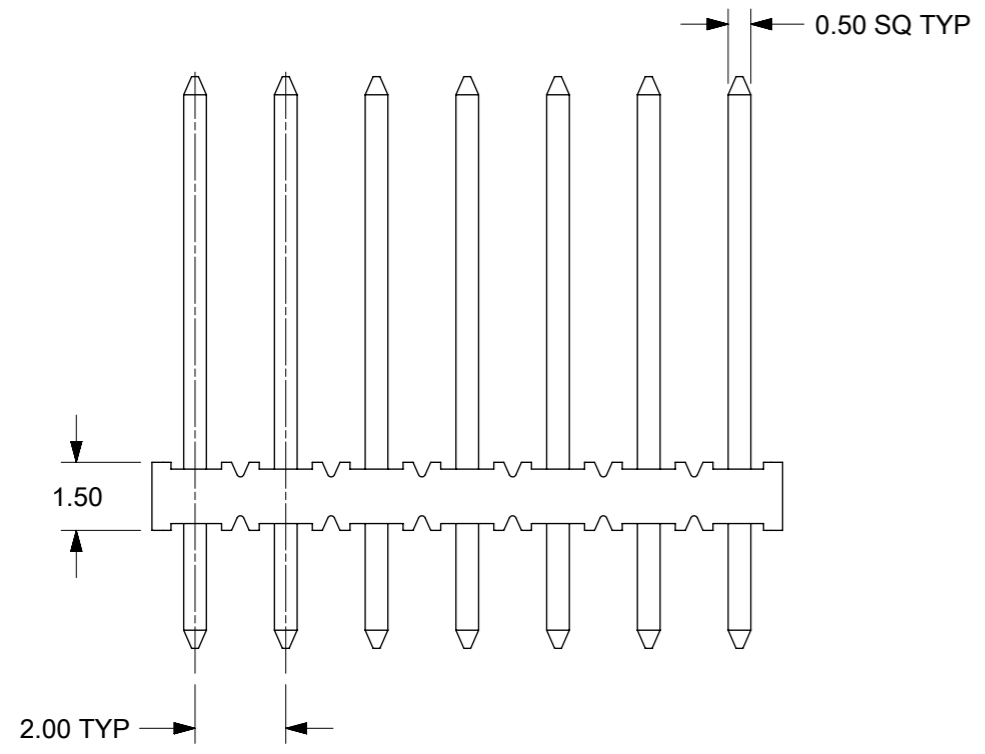

THIS DRAWING CONTAINS INFORMATION THAT IS PROPRIETARY TO MOLEX ELECTRONIC TECHNOLOGIES, LLC AND SHOULD NOT BE USED WITHOUT WRITTEN PERMISSION									
DIMENSION UNITS		SCALE		CURRENT REV DESC: BRIGHT TIN PHASE OUT				molex	
mm		NTS							
GENERAL TOLERANCES (UNLESS SPECIFIED)				EC NO: 679909		SALES DRAWING		2.00MM DUAL ROW HEADER SINGLE WAFER T/H	
				DRWN: AKUMAR19		PRODUCT CUSTOMER DRAWING			
				CHK'D: MRAMAKRISHNA		DOCUMENT NUMBER		DOC TYPE DOC PART REVISION	
4 PLACES ±				2021/06/15		SD-87758-030		PSD 001 B2	
3 PLACES ±				2021/10/11		MATERIAL NUMBER		CUSTOMER	
2 PLACES ± 0.2				2021/10/11		SEE TABLE		GENERAL MARKET	
1 PLACE ±				INITIAL REVISION:		SERIES		SHEET NUMBER	
0 PLACES ±				DRWN: KCHO		87758		1 OF 4	
ANGULAR TOL ± 3.0°				APPR: SLOW		DRAWING			
DRAFT WHERE APPLICABLE MUST REMAIN WITHIN DIMENSIONS				THIRD ANGLE PROJECTION		A3-SIZE			

DOCUMENT STATUS	P1	RELEASE DATE	2021/10/11	11:53:16
-----------------	----	--------------	------------	----------

PACKAGING OPRTION PART NO.			CKT SIZE	VOID POSITION	PLATING TYPE	CAP	PEG	DIMENSION				
TRAY	TUBE WITHOUT CAP	TUBE WITH CAP						A	B	C	D	E
87758-0201	----	----	2	----	1	N	N	1.90	----	12.60	8.50	2.60
87758-0202	----	----	2	----	2	N	N	1.90	----	12.60	8.50	2.60
87758-0203	----	----	2	----	3	N	N	1.90	----	12.60	8.50	2.60
87758-0204	----	----	2	----	4	N	N	1.90	----	12.60	8.50	2.60
87758-0205	----	----	2	----	5	N	N	1.90	----	12.60	8.50	2.60
87758-0206	----	----	2	----	6	N	N	1.90	----	12.60	8.50	2.60
87758-0401	----	----	4	----	1	N	N	3.90	2.00	12.60	8.50	2.60
87758-0402	----	----	4	----	2	N	N	3.90	2.00	12.60	8.50	2.60
87758-0403	----	----	4	----	3	N	N	3.90	2.00	12.60	8.50	2.60
87758-0404	----	----	4	----	4	N	N	3.90	2.00	12.60	8.50	2.60
87758-0405	----	----	4	----	5	N	N	3.90	2.00	12.60	8.50	2.60
87758-0406	----	----	4	----	6	N	N	3.90	2.00	12.60	8.50	2.60
87758-0420	----	---	4	----	5	N	N	3.90	2.00	15.50	11.50	2.50
87758-0601	----	----	6	----	1	N	N	5.90	4.00	12.60	8.50	2.60
87758-0602	----	----	6	----	2	N	N	5.90	4.00	12.60	8.50	2.60
87758-0603	----	----	6	----	3	N	N	5.90	4.00	12.60	8.50	2.60
87758-0604	----	----	6	----	4	N	N	5.90	4.00	12.60	8.50	2.60
87758-0605	----	----	6	----	5	N	N	5.90	4.00	12.60	8.50	2.60
87758-0606	----	----	6	----	6	N	N	5.90	4.00	12.60	8.50	2.60
87758-0620	----	----	6	----	5	N	N	5.90	4.00	15.50	11.50	2.50
87758-0647	----	----	6	----	4	N	N	5.90	4.00	11.45	6.85	3.10

PACKAGING OPRTION PART NO.			CKT SIZE	VOID POSITION	PLATING TYPE	CAP	PEG	DIMENSION				
TRAY	TUBE WITHOUT CAP	TUBE WITH CAP						A	B	D	C	E
87758-0801	----	----	8	----	1	N	N	7.90	6.00	12.60	8.50	2.60
87758-0802	----	----	8	----	2	N	N	7.90	6.00	12.60	8.50	2.60
87758-0803	----	----	8	----	3	N	N	7.90	6.00	12.60	8.50	2.60
87758-0804	----	----	8	----	4	N	N	7.90	6.00	12.60	8.50	2.60
87758-0805	----	----	8	----	5	N	N	7.90	6.00	12.60	8.50	2.60
87758-0806	----	----	8	----	6	N	N	7.90	6.00	12.60	8.50	2.60
87758-0846	----	----	8	----	4	N	N	7.90	6.00	6.38	10.50	2.60
87758-0008	----	----	8	----	4	N	N	7.90	6.00	10.00	14.10	2.60
87758-0808	----	----	8	----	5	N	N	7.90	6.00	9.70	4.00	4.20
87758-0820	----	----	8	----	1	N	N	7.90	6.00	11.50	5.00	5.00
87758-1001	----	----	10	----	1	N	N	9.90	8.00	12.60	8.50	2.60
87758-1002	----	----	10	----	2	N	N	9.90	8.00	12.60	8.50	2.60
87758-1003	----	----	10	----	3	N	N	9.90	8.00	12.60	8.50	2.60
87758-1004	----	----	10	----	4	N	N	9.90	8.00	12.60	8.50	2.60
87758-1005	----	----	10	----	5	N	N	9.90	8.00	12.60	8.50	2.60
87758-1006	----	----	10	----	6	N	N	9.90	8.00	12.60	8.50	2.60
87758-1007	----	----	10	10	4	N	N	9.90	8.00	8.10	4.00	2.60
87758-1008	----	----	10	10	5	N	N	9.90	8.00	8.70	4.00	3.20
87758-1012	----	----	10	----	4	N	N	9.90	8.00	11.75	7.65	2.60
87758-1020	B1	----	10	2	1	N	N	9.90	8.00	4.00	9.50	4.00
87758-1201	----	----	12	----	1	N	N	11.90	10.00	12.60	8.50	2.60
87758-1202	----	----	12	----	2	N	N	11.90	10.00	12.60	8.50	2.60
87758-1203	----	----	12	----	3	N	N	11.90	10.00	12.60	8.50	2.60
87758-1204	----	----	12	----	4	N	N	11.90	10.00	12.60	8.50	2.60
87758-1205	----	----	12	----	5	N	N	11.90	10.00	12.60	8.50	2.60
87758-1206	----	----	12	----	6	N	N	11.90	10.00	12.60	8.50	2.60
87758-1220	----	----	12	----	5	N	N	11.90	10.00	15.50	11.50	2.50

THIS DRAWING CONTAINS INFORMATION THAT IS PROPRIETARY TO MOLEX ELECTRONIC TECHNOLOGIES, LLC AND SHOULD NOT BE USED WITHOUT WRITTEN PERMISSION

SCALE: mm NTS

GENERAL TOLERANCES (UNLESS SPECIFIED)

4 PLACES	±	±
3 PLACES	±	±
2 PLACES	± 0.2	±
1 PLACE	±	±
0 PLACES	±	±

ANGULAR TOL ± 3.0°

DRAFT WHERE APPLICABLE MUST REMAIN WITHIN DIMENSIONS

THIRD ANGLE PROJECTION

DRAWING: A3-SIZE

SERIES: 87758

MATERIAL NUMBER: SEE TABLE

CUSTOMER: GENERAL MARKET

SHEET NUMBER: 2 OF 4

EC NO: 679909
 DRWN: AKUMAR19
 CHK'D: MRAMAKRISHNA
 APPR: MRAMAKRISHNA

INITIAL REVISION:
 DRWN: KCHO
 APPR: SLOW

SALES DRAWING
 2.00MM DUAL ROW HEADER SINGLE WAFER T/H

PRODUCT CUSTOMER DRAWING

DOCUMENT NUMBER: SD-87758-030
 DOC TYPE: PSD
 DOC PART: 001
 REVISION: B2

10 9 8 7 6 5 4 3 2 1

PACKAGING OPRTION PART NO.			CKT SIZE	VOID POSITION	PLATING TYPE	CAP	PEG	DIMENSION				
TRAY	TUBE WITHOUT CAP	TUBE WITH CAP						A	B	C	D	E
87758-1401	----	----	14	----	1	N	N	13.90	12.00	12.60	8.50	2.60
87758-1402	----	----	14	----	2	N	N	13.90	12.00	12.60	8.50	2.60
87758-1403	----	----	14	----	3	N	N	13.90	12.00	12.60	8.50	2.60
87758-1404	----	----	14	----	4	N	N	13.90	12.00	12.60	8.50	2.60
87758-1405	----	----	14	----	5	N	N	13.90	12.00	12.60	8.50	2.60
87758-1406	----	----	14	----	6	N	N	13.90	12.00	12.60	8.50	2.60
87758-0014	----	----	14	----	4	N	N	13.90	12.00	8.40	5.50	1.40
87758-1492	----	----	14	----	6	N	N	13.90	12.00	14.40	10.00	2.90
87758-1601	----	----	16	----	1	N	N	15.90	14.00	12.60	8.50	2.60
87758-1602	----	----	16	----	2	N	N	15.90	14.00	12.60	8.50	2.60
87758-1603	----	----	16	----	3	N	N	15.90	14.00	12.60	8.50	2.60
87758-1604	----	----	16	----	4	N	N	15.90	14.00	12.60	8.50	2.60
87758-1605	----	----	16	----	5	N	N	15.90	14.00	12.60	8.50	2.60
87758-1606	----	----	16	----	6	N	N	15.90	14.00	12.60	8.50	2.60
87758-0016	----	----	16	----	6	N	N	15.90	14.00	10.30	6.30	2.50
87758-0017	----	----	16	----	6	N	N	15.90	14.00	10.70	6.60	2.60
87758-0018	----	----	16	----	6	N	N	15.90	14.00	10.30	6.30	2.50
87758-1620	----	----	16	----	5	N	N	15.90	14.00	16.40	11.70	3.20
87758-1801	----	----	18	----	1	N	N	17.90	16.00	12.60	8.50	2.60
87758-1802	----	----	18	----	2	N	N	17.90	16.00	12.60	8.50	2.60
87758-1803	----	----	18	----	3	N	N	17.90	16.00	12.60	8.50	2.60
87758-1804	----	----	18	----	4	N	N	17.90	16.00	12.60	8.50	2.60
87758-1805	----	----	18	----	5	N	N	17.90	16.00	12.60	8.50	2.60
87758-1806	----	----	18	----	6	N	N	17.90	16.00	12.60	8.50	2.60

PACKAGING OPRTION PART NO.			CKT SIZE	VOID POSITION	PLATING TYPE	CAP	PEG	DIMENSION				
TRAY	TUBE WITHOUT CAP	TUBE WITH CAP						A	B	C	D	E
87758-2001	----	----	20	----	1	N	N	19.90	18.00	12.60	8.50	2.60
87758-2002	----	----	20	----	2	N	N	19.90	18.00	12.60	8.50	2.60
87758-2003	----	----	20	----	3	N	N	19.90	18.00	12.60	8.50	2.60
87758-2004	----	----	20	----	4	N	N	19.90	18.00	12.60	8.50	2.60
87758-2005	----	----	20	----	5	N	N	19.90	18.00	12.60	8.50	2.60
87758-2005	----	----	20	----	6	N	N	19.90	18.00	12.60	8.50	2.60
87758-0006	----	----	20	----	5	N	N	19.90	18.00	11.92	5.21	5.21
87758-2046	----	----	20	----	5	N	N	19.90	18.00	7.70	4.45	1.75
87758-2201	----	----	22	----	1	N	N	21.90	20.00	12.60	8.50	2.60
87758-2202	----	----	22	----	2	N	N	21.90	20.00	12.60	8.50	2.60
87758-2203	----	----	22	----	3	N	N	21.90	20.00	12.60	8.50	2.60
87758-2204	----	----	22	----	4	N	N	21.90	20.00	12.60	8.50	2.60
87758-2205	----	----	22	----	5	N	N	21.90	20.00	12.60	8.50	2.60
87758-2206	----	----	22	----	6	N	N	21.90	20.00	12.60	8.50	2.60
87758-2401	----	----	24	----	1	N	N	23.90	22.00	12.60	8.50	2.60
87758-2402	----	----	24	----	2	N	N	23.90	22.00	12.60	8.50	2.60
87758-2403	----	----	24	----	3	N	N	23.90	22.00	12.60	8.50	2.60
87758-2404	----	----	24	----	4	N	N	23.90	22.00	12.60	8.50	2.60
87758-2405	----	----	24	----	5	N	N	23.90	22.00	12.60	8.50	2.60
87758-2406	----	----	24	----	6	N	N	23.90	22.00	12.60	8.50	2.60

DOCUMENT STATUS P1 RELEASE DATE 2021/10/11 11:53:16

THIS DRAWING CONTAINS INFORMATION THAT IS PROPRIETARY TO MOLEX ELECTRONIC TECHNOLOGIES, LLC AND SHOULD NOT BE USED WITHOUT WRITTEN PERMISSION

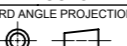
DIMENSION UNITS	SCALE	CURRENT REV DESC: BRIGHT TIN PHASE OUT	
mm	NTS		
GENERAL TOLERANCES (UNLESS SPECIFIED)			
	MM	INCH	EC NO: 679909 DRWN: AKUMAR19 2021/06/15 CHK'D: MRAMAKRISHNA 2021/10/11 APPR: MRAMAKRISHNA 2021/10/11 INITIAL REVISION: DRWN: KCHO 2004/11/05 APPR: SLOW 2004/11/26
4 PLACES	±	±	
3 PLACES	±	±	
2 PLACES	± 0.2	±	
1 PLACE	±	±	
0 PLACES	±	±	DOCUMENT NUMBER SD-87758-030
ANGULAR TOL	± 3.0°		DOC TYPE PSD
DRAFT WHERE APPLICABLE MUST REMAIN WITHIN DIMENSIONS	THIRD ANGLE PROJECTION	DRAWING	DOC PART 001
		SERIES	REVISION B2
		MATERIAL NUMBER	SEE TABLE
		CUSTOMER	GENERAL MARKET
		SHEET NUMBER	3 OF 4

9 8 7 6 5 4 3 2 1

PACKAGING OPRTION PART NO.			CKT SIZE	VOID POSITION	PLATING TYPE	CAP	PEG	DIMENSION				
TRAY	TUBE WITHOUT CAP	TUBE WITH CAP						A	B	C	D	E
87758-0002	----	----	26	26	4	N	N	25.90	24.00	9.56	4.06	4.00
87758-2608	----	----	26	----	5	N	N	25.90	24.00	9.70	4.00	4.20
87758-2672	----	----	26	----	4	Y	N	25.90	24.00	12.76	8.66	2.60
87758-0009	----	----	40	----	4	N	N	39.90	38.00	11.98	5.24	5.24
87758-4000	----	----	40	----	4	N	N	39.90	38.00	12.80	7.90	3.40
87758-7006	----	----	42	19 & 22	1	N	N	41.90	40.00	12.7	8.50	2.70
87758-4471	----	----	44	19	5	N	N	43.90	42.00	8.10	4.00	2.60
87758-4477	----	----	44	20	4	N	N	43.90	42.00	8.10	4.00	2.60
87758-5099	----	----	50	----	4	N	N	49.90	48.00	11.00	6.50	3.00
87758-0050	----	----	50	----	4	N	N	49.90	48.00	18.70	13.00	4.20

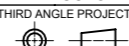
THIS DRAWING CONTAINS INFORMATION THAT IS PROPRIETARY TO MOLEX ELECTRONIC TECHNOLOGIES, LLC AND SHOULD NOT BE USED WITHOUT WRITTEN PERMISSION											
DIMENSION UNITS		SCALE		CURRENT REV DESC: BRIGHT TIN PHASE OUT							
mm		NTS									
GENERAL TOLERANCES (UNLESS SPECIFIED)											
		MM		INCH							
4 PLACES		±		±							
3 PLACES		±		±							
2 PLACES		± 0.2		±							
1 PLACE		±		±							
0 PLACES		±		±							
ANGULAR TOL		± 3.0°									
DRAFT WHERE APPLICABLE MUST REMAIN WITHIN DIMENSIONS				THIRD ANGLE PROJECTION		DRAWING		SERIES		MATERIAL NUMBER	
						A3-SIZE		87758		SEE TABLE	
DOCUMENT STATUS				P1		RELEASE DATE		2021/10/11		11:53:16	
		9		8		7		6		5	
		4		3		2		1			