

Getting started with the STEVAL-ISB045V1 2.5 W wireless charger transmitter evaluation kit

Introduction

The **STEVAL-ISB045V1** evaluation kit includes the STEVAL-ISB045V1T wireless battery charger transmitter evaluation board based on the **STWBC-WA** digital controller, the firmware and the STEVAL-WBCDNGV1 USB-to-UART dongle needed to use the **STSW-STWBCGUI**.

The **STWBC-WA** firmware offers you the flexibility of modifying LEDs or GPIO behavior and customizing I²C and UART signals. The layout is based on cost-effective two-layer PCB.

Tools for the **STEVAL-ISB045V1** evaluation kit are available on www.st.com and allow you to access run time information such as regulation error, frequency or protocol status.

Figure 1. STEVAL-ISB045V1 evaluation kit



1 Getting started

1.1 System requirements

To use the [STEVAL-ISB045V1](#) evaluation board with the graphical user interface (GUI), you need:

- a PC with Microsoft® Windows® operating system (XP or later versions)
- NET Framework 4
- a USB-to-UART cable to connect the board to the PC.

1.2 Package contents

- Hardware:
 - an [STEVAL-ISB045V1](#) evaluation kit
- Software:
 - ST-LINK USB driver
 - STVP programming software (integrated in ST_toolset available on www.st.com)
 - FTDI VCP driver (<http://www.ftdichip.com/Drivers/VCP.htm>)
 - PC GUI installation package

Table 1. STEVAL-ISB045V1T electrical performance

Parameter	Input characteristics	Min.	Typ.	Max.	Unit	Notes and conditions
Vin	Input voltage	4.7	5	5.5	V	
Iin	Input current		750	900	mA	Vin = 5 V, Pout (Rx) = 2.5 W
	Input current (Rx no-load)		200		mA	
	Input standby current		0.32		mA	1.6 mW
System characteristics						
FS	Switching frequency	130		148	kHz	
Duty cycle		20		50	%	
η	Full load efficiency		70		%	Vin = 5 V, Pout (Rx) = 2.5 W

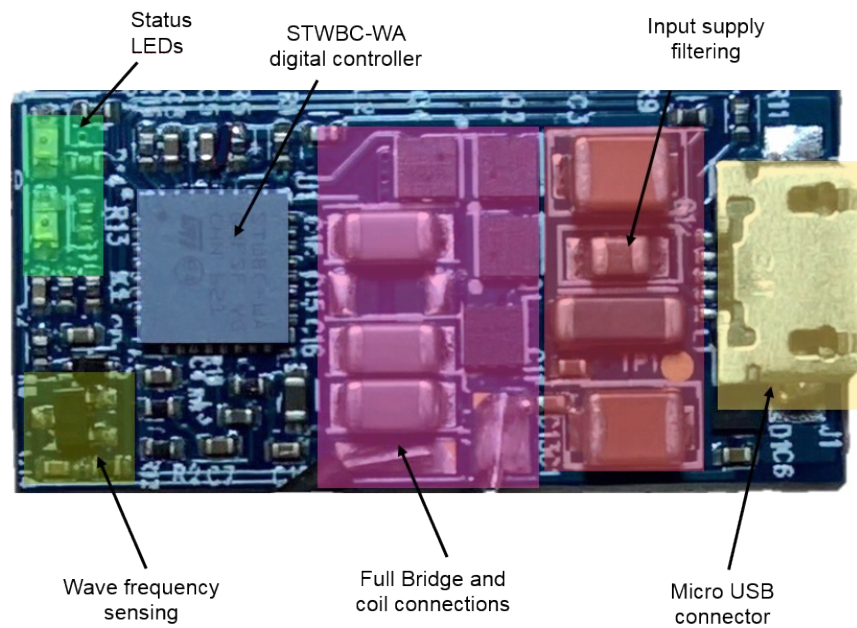
Figure 3. STEVAL-ISB045V1T evaluation board: components


Figure 4. STEVAL-ISB045V1T evaluation board: top reference designators

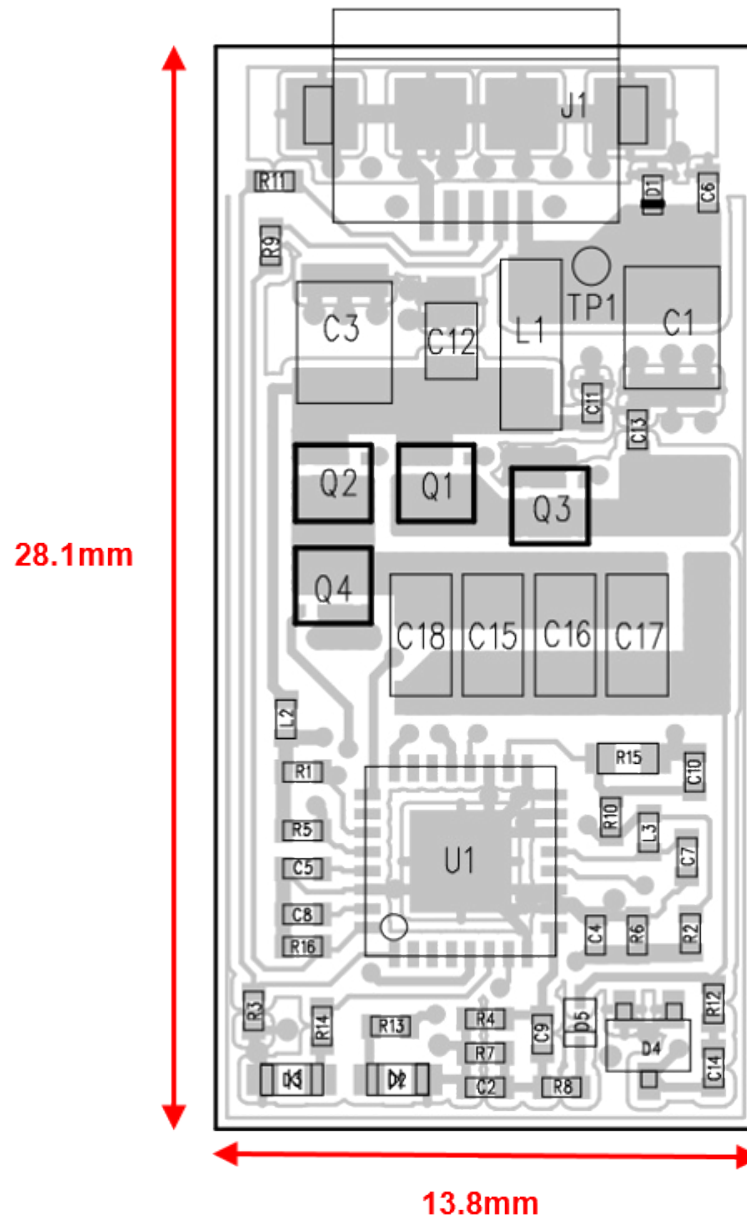
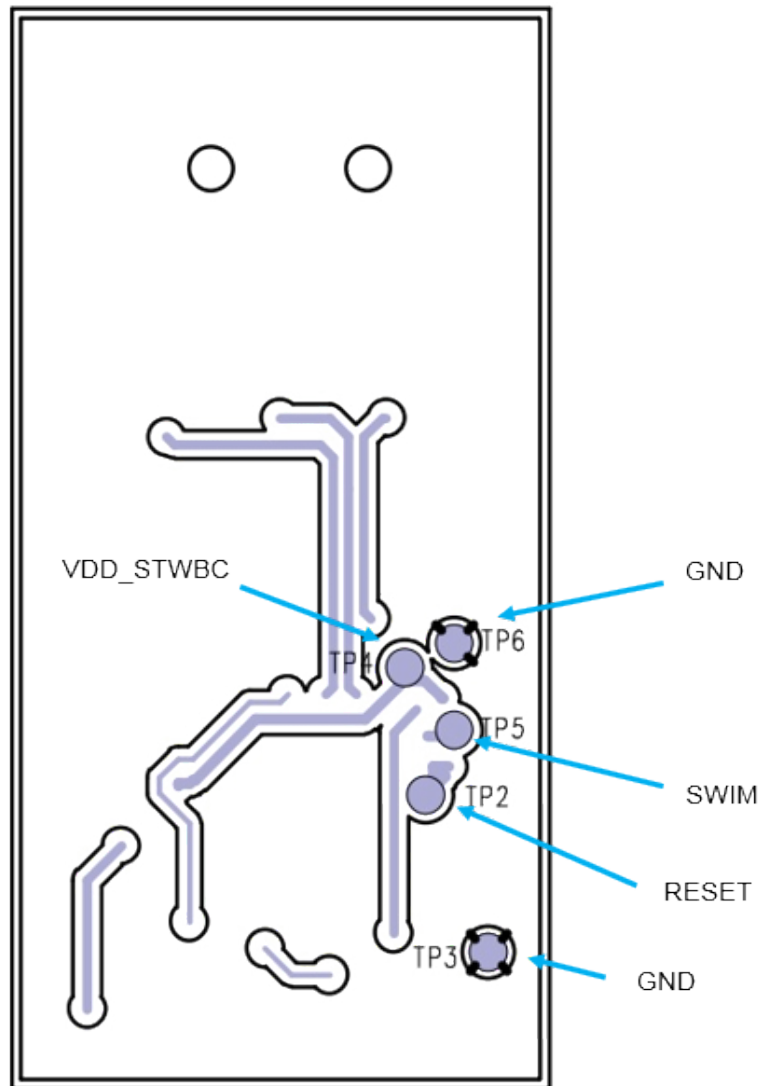


Figure 5. STEVAL-ISB045V1T evaluation board: bottom reference designators (TP for SWIM connection)

Table 2. STEVAL-ISB045V1T evaluation board: connector and test points

Connector reference	Description
J1	USB to UART connector used for the GUI and for the board supply
TP1	VIN (+5V DC)
TP2	RESET
TP3	GND
TP4	VDD_STWBC
TP5	SWIM
TP6	GND (for SWIM connection)

The STEVAL-WBCDNGV1 USB-to-UART dongle is based on the FT232R IC by FTDI.

It allows monitoring the functions and tuning the parameters of the STEVAL-ISB045V1T transmitter board through the [STSW-STWBCGUI](#).

2.3 STWBC-WA pinout and pin description

Figure 8. STWBC-WA pinout configuration

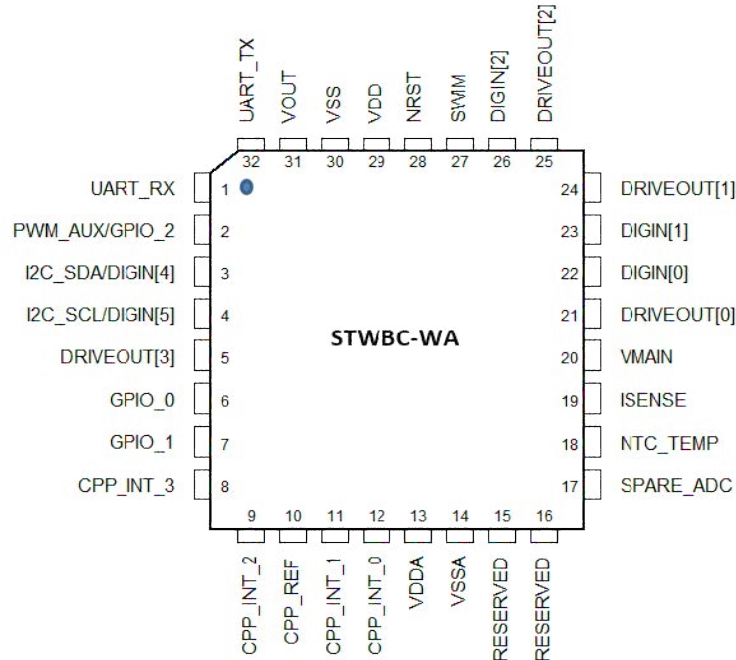


Table 4. STWBC-WA pin description

Pin number	Pin name	Pin type	Turnkey firmware description	Signal name
1	UART_RX ⁽¹⁾	DI	Uart RX link on USB connector	USB_DP
2	PWM_AUX/GPIO_2 ⁽¹⁾	DO	Not used, must not be connected to any potential	PWM_AUX
3	I2C_SDA/DIGIN[4] ⁽¹⁾		Inactive (internal pull up)	I2C_SDA
4	I2C_SCL/DIGIN[5] ⁽¹⁾		Inactive (internal pull up)	I2C_SCL
5	DRIVEOUT[3]	DO	Output signal for full bridge right low side driver	DNBR
6	GPIO_0 ⁽¹⁾	DO	Digital output for the green light indicator	LEDG
7	GPIO_1 ⁽¹⁾	DO	Digital output for the red light indicator	LEDR
8	CPP_INT_3	AI	Connected to GND	CPP_INT3
9	CPP_INT_2	AI	V_SNS symbol detector based on voltage variation	V_SNS
10	CPP_REF	AI	External reference for CPP_INT_3 (if not used, must be tied to GND)	CPP_REF
11	CPP_INT_1	AI	Connected to GND	CPP_INT1
12	CPP_INT_0	AI	WAVE_SNS symbol detector based on delta frequency	WAVE_SNS
13	VDDA	PS	Analog power supply	VDDA
14	VSSA	PS	Analog ground	VSSA
15	TANK_VOLTAGE	AI	Not used, connected to GND	TANK_VOLTAGE
16	VBRIDGE		Not used, connected to GND	VBRIDGE
17	SPARE_ADC ⁽¹⁾		Not used, connected to GND	SPARE_ADC
18	NTC_TEMP	AI	Coil temperature measurement with NTC	COIL_TEMP

Pin number	Pin name	Pin type	Turnkey firmware description	Signal name
19	ISENSE	AI	Not used, connected to GND	ISENSE
20	VMAIN	AI	5 V input voltage monitor	VBUS
21	DRIVEOUT[0]	DO	Output signal for full bridge left low side driver	DNBL
22	DIGIN[0] ⁽¹⁾		Inactive (internal pull up)	DIGIN[0] ⁽¹⁾
23	DIGIN[1] ⁽¹⁾		Inactive (internal pull up)	DIGIN[1] ⁽¹⁾
24	DRIVEOUT[1]	DO	Output signal for full bridge left high side driver	UPBL
25	DRIVEOUT[2]	DO	Output signal for full bridge right high side driver	UPBR
26	DIGIN[2] ⁽¹⁾		Not connected	DIGIN[2] ⁽¹⁾
27	SWIM	DIO	Digital I/O for debug interface	SWIM
28	NRST	DI	Reset input monitoring	RESET
29	VDD	PS	Digital and I/O Power supply	VDD
30	VSS	PS	Digital and I/O Ground	GND
31	VOUT	Supply	Internal LDO output	VOUT
32	UART_TX ⁽¹⁾	DO	Uart TX link on USB connector	USB_DM

1. API configurable

Note: All analog inputs are VDD compliant but can be used only between 0 and 1.2V.

3 Download procedure

To download the firmware to the board, install the GUI software which allows complete board monitoring via UART signals. To use the [STSW-STWBCGUI](#), UART signals must therefore be accessible.

3.1 STSW-STWBCGUI software installation

Step 1. Install the GUI by launching the STWBC_GUI_Setup.msi installation file.

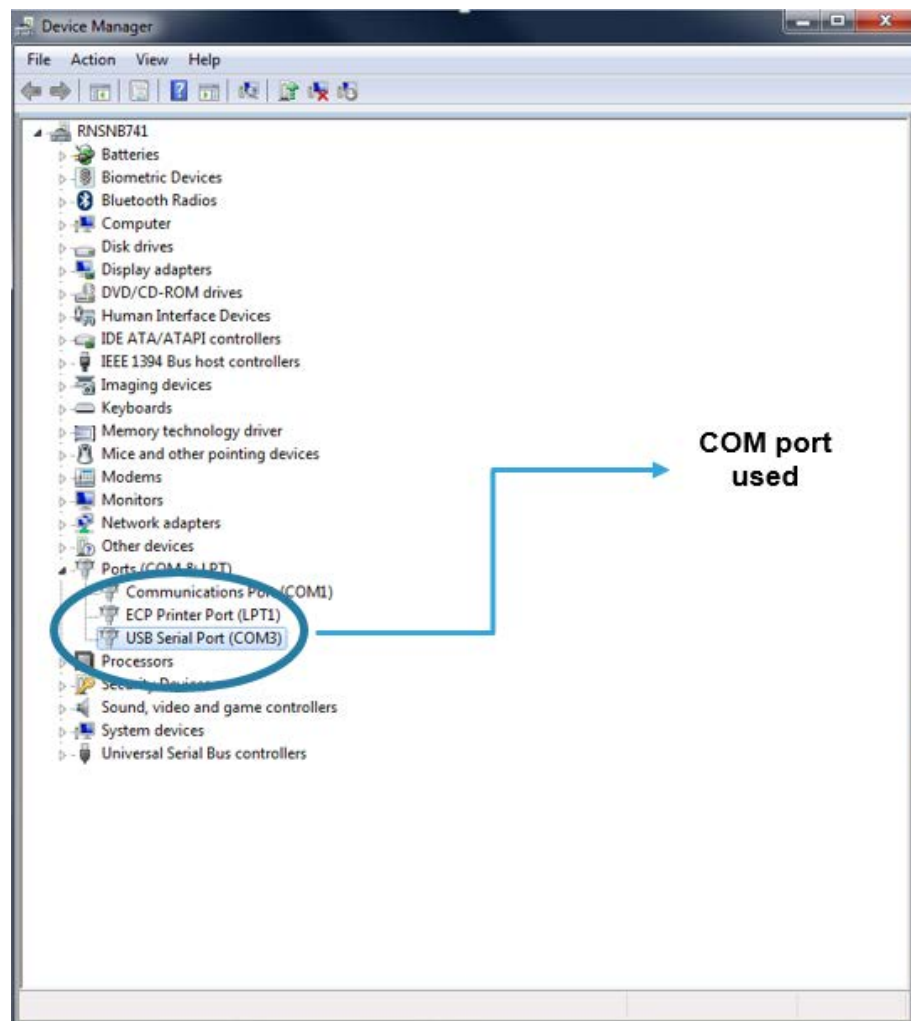
Figure 9. STSW-STWBCGUI installation file

Name	Date modified	Type	Size
setup.exe	3/14/2017 11:49 AM	Application	418 KB
STWBC_GUI_Setup.msi	3/14/2017 11:50 AM	Windows Installer ...	2,011 KB

Step 2. Connect the UART cable from the transmitter board to the USB-to-UART dongle on your PC or laptop.

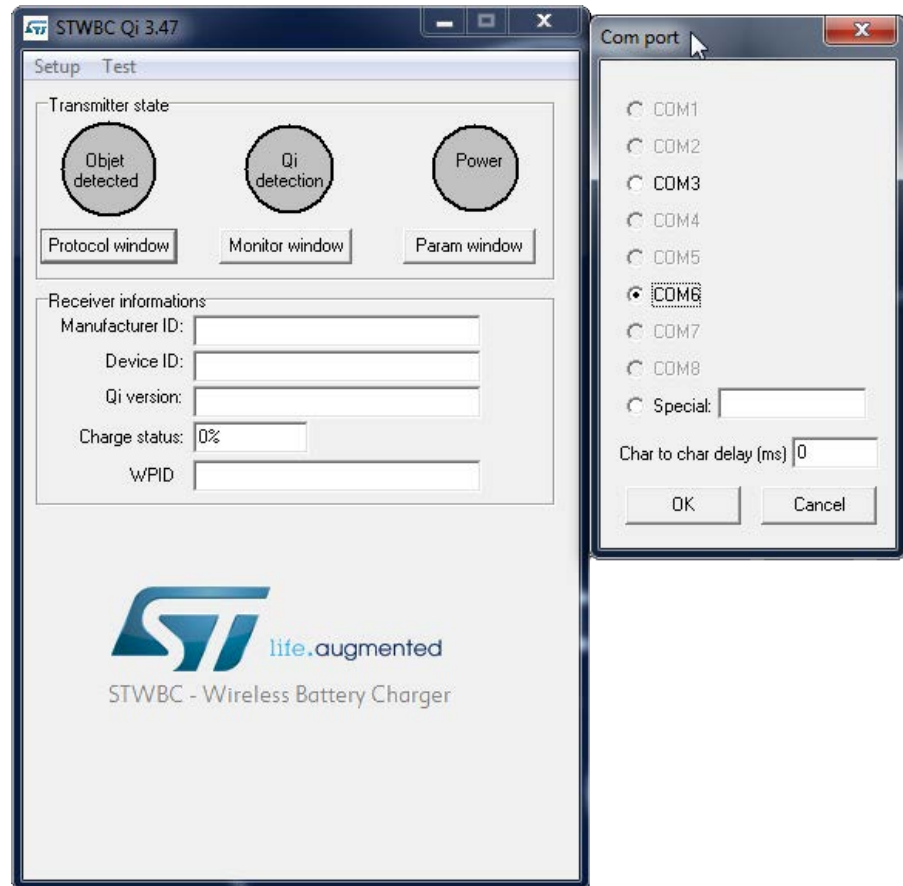
Step 3. Check Windows Device Manager to identify the correct port number and select the appropriate USB serial COM port.

Figure 10. Windows Device Manager: COM port selection



- Step 4.** Enter a specific COM port number (if not listed in the selection window) in the **[Special]** text box (e.g., "COM12" or the specific syntax \\.\COM12).
If the GUI is turned off, ensure that the COM port is not being used on your computer. Otherwise, try another USB port.

Figure 11. STSW-STWBCGUI start screen



- Step 5.** Press OK.
The GUI is ready to run.

3.2 Firmware download via STSW-STWBCGUI

The following sections describe the firmware download via the UART connector using STSW-STWBCGUI.

The download contains 3 files incorporated in a single *.cab file.

There are two different use cases for the [STWBC-WA](#), each with its own specific procedure:

1. the chip has never been programmed
2. the chip has already been programmed and you are updating the firmware

Important:

Presence detection calibration must be done once after each firmware download (see [Section 5.2 Presence detection calibration procedure](#)).

3.2.1 Download procedure with a new chip (never been programmed)

If the chip has never been programmed, Download Mode is enabled by default.

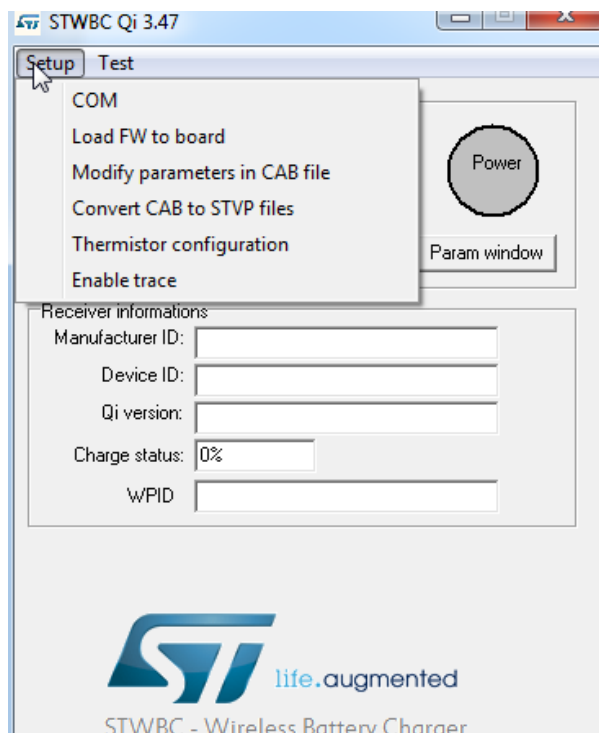
- Step 1.** Connect the USB-to-UART dongle to the computer.
 Do not connect the transmitter board for the moment.
 Ensure a jumper is placed on the dongle J3 connector to supply the transmitter board via the PC.

Figure 12. Dongle connection



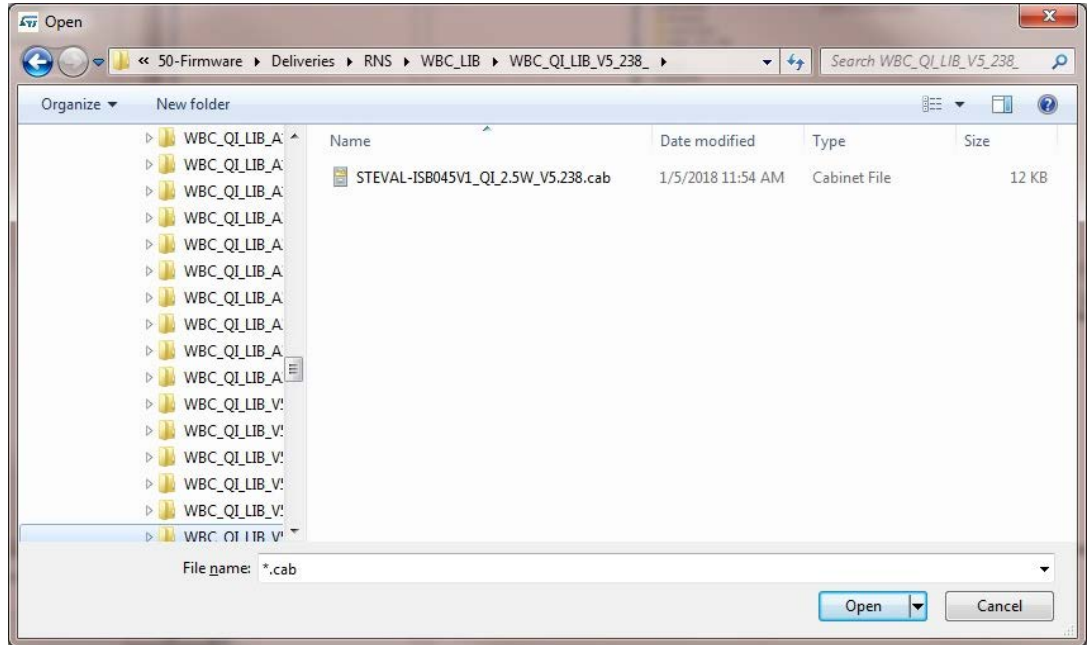
- Step 2.** From the GUI, select **[Setup]>[Load FW to board]**.

Figure 13. Firmware download with STSW-STWBCGUI



Step 3. Select the CAB file containing the firmware to download.

Figure 14. Firmware file selection



Step 4. When the DOS window appears, power the transmitter board on by connecting it to the dongle using a micro-USB cable.

Figure 15. Power on message

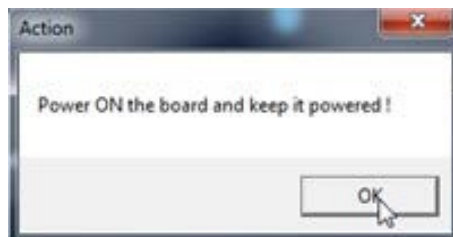


Figure 16. STEVAL-ISB045V1 evaluation kit connection



- Step 5.** Follow the download progress in the DOS window and power off the board when prompted

Figure 17. DOS window: download in progress

```

C:\Christian\TOOLS\GUI_3.47\stwbc_loader.exe
Synchronization starting
Synchronization OK

Downloading :
Program : C:\Users\chgautie\AppData\Roaming\STMicroelectronics\STWBC_TMP\program.bin
Parameters : C:\Users\chgautie\AppData\Roaming\STMicroelectronics\STWBC_TMP\parameters.bin
Options : C:\Users\chgautie\AppData\Roaming\STMicroelectronics\STWBC_TMP\options.bin
sending code - OK
sending code - OK
sending C:\Users\chgautie\AppData\Roaming\STMicroelectronics\STWBC_TMP\program.bin_
  
```

Figure 18. Download success message



3.2.2 Firmware upgrade procedure (chip already programmed)

If a chip has already been programmed with the firmware, Download mode is disabled and a special command needs to be sent to **STWBC-WA** to enable Download mode.

- Step 1.** Connect the USB-to-UART dongle to the transmitter board to supply it.
- Step 2.** The STWBC-WA UART Rx/Tx signals are accessible on the transmitter board micro-connector (muxed respectively on USB_DP and USB_DM).
- Step 3.** From the **STSW-STWBCGUI**, select **Load FW to board** from the setup menu (see [Figure 13. Firmware download with STSW-STWBCGUI](#))
- Step 4.** As prompted, select the CAB file containing the firmware to download (see [Figure 14. Firmware file selection](#))
- Step 5.** As prompted, power the board on and keep it powered (see [Figure 15. Power on message](#))
- Step 6.** Follow the download progress in the DOS window and power the board off when prompted (see [Figure 18. Download success message](#))

3.3 Firmware download with command line (UART)

3.3.1 Firmware download with written chip

Step 1. Create a dedicated directory with the following files:

- STWBC_Loader.exe
- stwbc_loader_not_empty.bat
- enable_boot.bin
- "firmware version".cab

Step 2. From the [STSW-STWBCGUI](#) folder, call the "stwbc_loader_not_empty.bat" file from the command line. When you call the batch file, you must also specify:

- COM number (e.g. COM2)
- File name ("*firmware name.cab*")

Figure 19. STSW-STWBCGUI command line

```

Administrator: C:\windows\system32\CMD.exe
C:\STWBC_PRODUCTION_MC>
C:\STWBC_PRODUCTION_MC>stwbc_loader_not_empty.bat COM6 WBC_FW_ST_MP2_U1.48.cab
C:\STWBC_PRODUCTION_MC>mode COM6 BAUD=57600 PARITY=n DATA=8
Status for device COM6:
-----
Baud:          57600
Parity:        None
Data Bits:     8
Stop Bits:     1
Timeout:      ON
XON/XOFF:     OFF
CTS handshaking: OFF
DSR handshaking: OFF
DSR sensitivity: OFF
DTR circuit:  ON
RTS circuit:  ON

C:\STWBC_PRODUCTION_MC>type enable_boot.bin 1>\\.COM6
C:\STWBC_PRODUCTION_MC>stwbc_loader.exe -com \\.COM6 -cab WBC_FW_ST_MP2_U1.48.cab
Synchronization starting
Synchronization OK

Downloading :
Program : C:\Users\chgautie\AppData\Roaming\STMicroelectronics\STWBC_TMP\program.m.bin
Parameters : C:\Users\chgautie\AppData\Roaming\STMicroelectronics\STWBC_TMP\parameters.bin
Options : C:\Users\chgautie\AppData\Roaming\STMicroelectronics\STWBC_TMP\options.s.bin
sending code - OK
sending code - OK
sending C:\Users\chgautie\AppData\Roaming\STMicroelectronics\STWBC_TMP\program.m.in - OK
sending C:\Users\chgautie\AppData\Roaming\STMicroelectronics\STWBC_TMP\parameters.s.bin - OK
sending C:\Users\chgautie\AppData\Roaming\STMicroelectronics\STWBC_TMP\options.s.in - OK

SUCCESS

C:\STWBC_PRODUCTION_MC>_
    
```

3.3.2 Firmware download with blank chip

If the [STWBC-WA](#) memory is erased, the procedure sequence is a bit different.

Step 1. Connect the USB-to-UART dongle to the computer, without connecting the transmitter board.

- Step 2.** Execute the command line as per the example below, with the appropriate firmware file name.
- Step 3.** Once the synchronisation starting message appears, connect the transmitter board to the dongle.

Figure 20. STSW-STWBCGUI command line with blank chip

```

Command Prompt
C:\STWBC_PRODUCTION_EP_rev2>stwbc_loader.exe -com COM5 -cab wbc.cab

Synchronization starting
Synchronization OK

Downloading :
Program : C:\Users\olpalier\AppData\Roaming\STMicroelectronics\STWBC_TMP\program.bin
Parameters : C:\Users\olpalier\AppData\Roaming\STMicroelectronics\STWBC_TMP\parameters.bin
Options : C:\Users\olpalier\AppData\Roaming\STMicroelectronics\STWBC_TMP\options.bin
sending code - OK
sending code - OK
sending C:\Users\olpalier\AppData\Roaming\STMicroelectronics\STWBC_TMP\program.bin - OK
sending C:\Users\olpalier\AppData\Roaming\STMicroelectronics\STWBC_TMP\parameters.bin - OK
sending C:\Users\olpalier\AppData\Roaming\STMicroelectronics\STWBC_TMP\options.bin - OK

SUCCESS
  
```

Note: If the COM port is > COM8, use the syntax `\\.\\COMx`, where COMx is the COM port number.

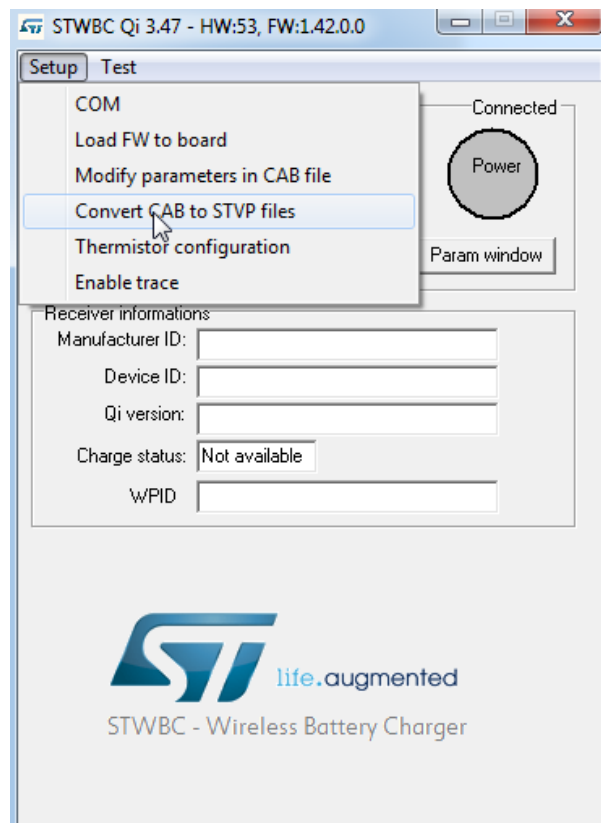
Note: A dedicated tool is available for simultaneous downloads (refer to the [STSW-STWBCFWDT](#) firmware downloader tool).

3.4 STVP file creation

To use the STVP to download, you must generate new files from the *.cab via the [STSW-STWBCGUI](#).

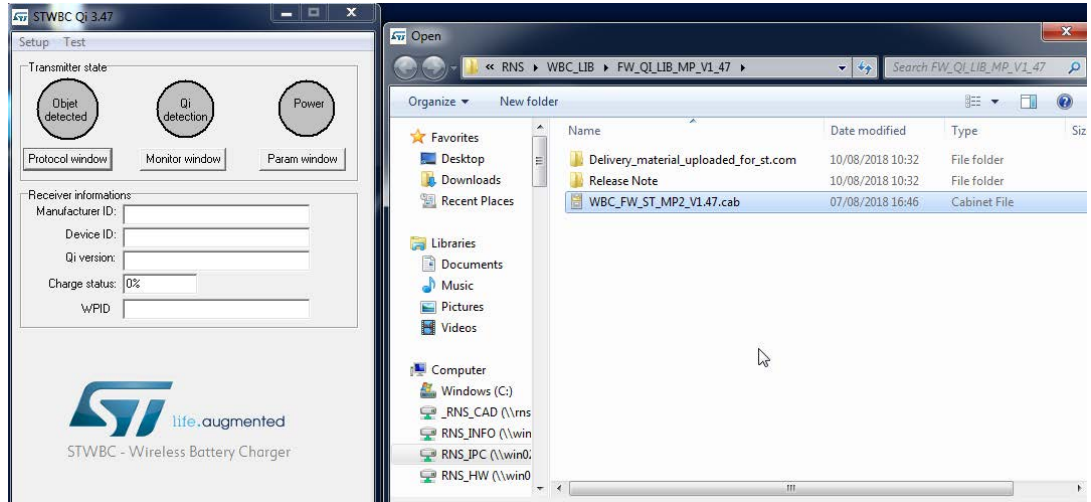
- Step 1.** Select the convert **CAB to STVP files** command from the STSW-STWBCGUI setup menu.

Figure 21. STSW-STWBCGUI: convert CAB to STVP files



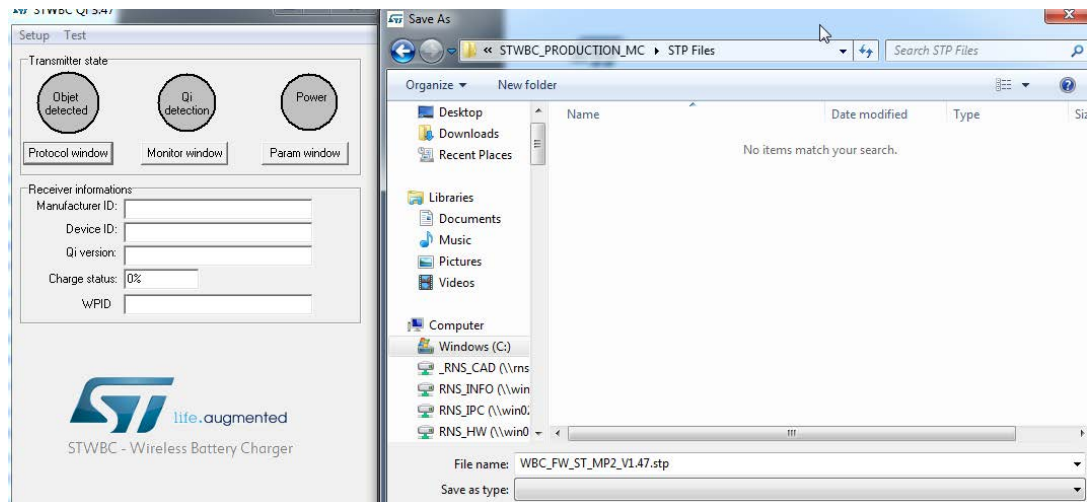
Step 2. Follow the prompt to select the appropriate cab file.

Figure 22. Selecting the CAB file to be converted



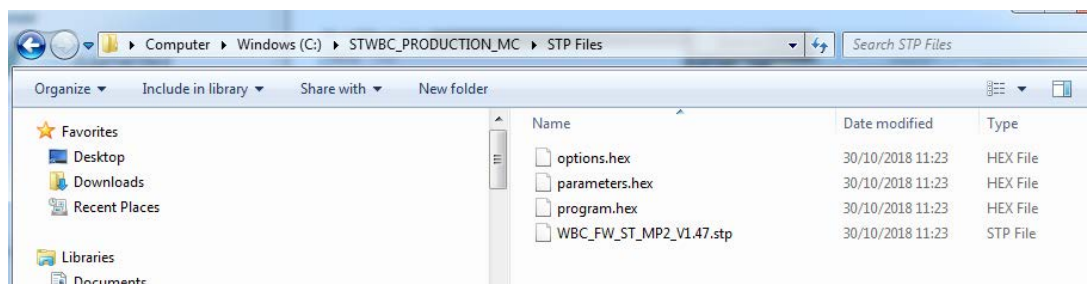
Step 3. Follow the prompt to provide the project file name.

Figure 23. Selecting the STVP project file name



Four files are generated as shown below.

Figure 24. STVP project files



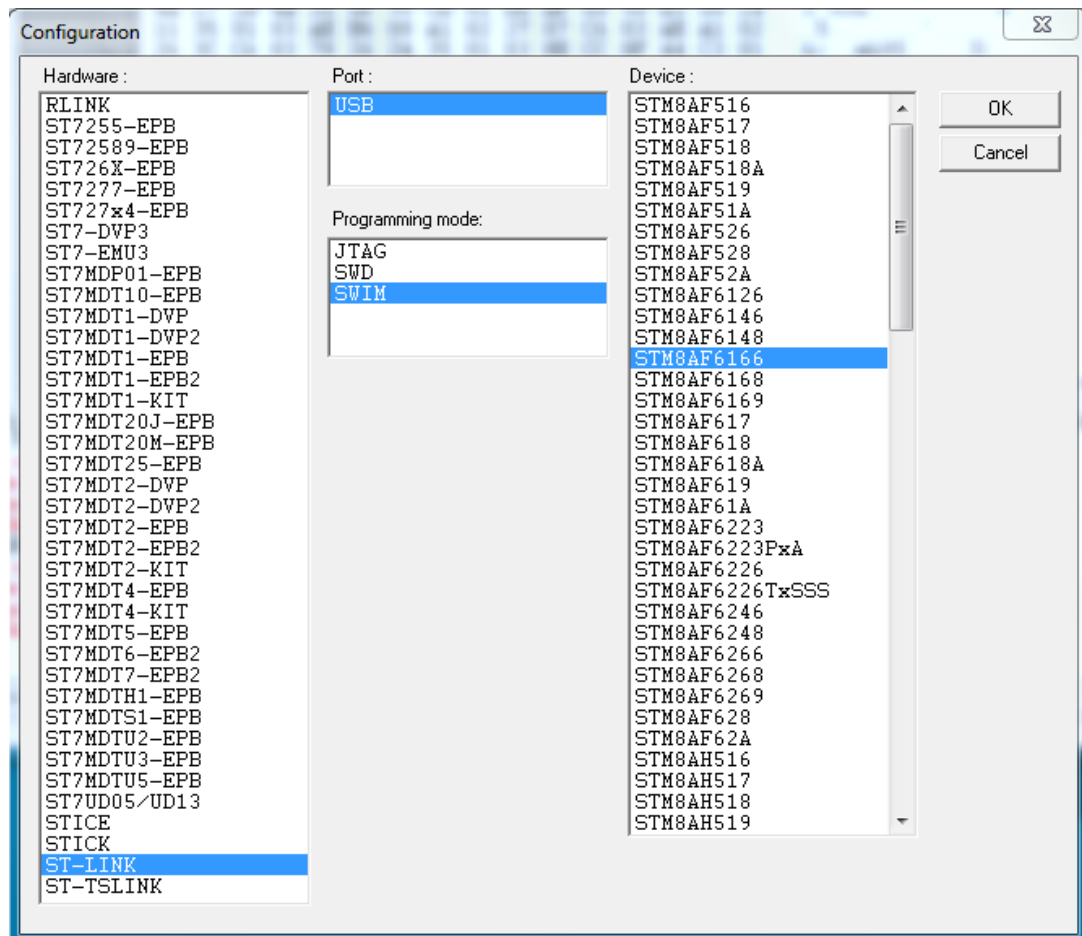
Note: Refer to [STSW-STWBCFWD](#) STWBC firmware downloader tool for further details.

3.5 Firmware download with STVP

Requirements:

- ST-LINK USB driver installed
- ST STVP programming tool installed
- ST-LINK hardware tools connected to the transmitter board SWIM signals
- STVP configured as shown below

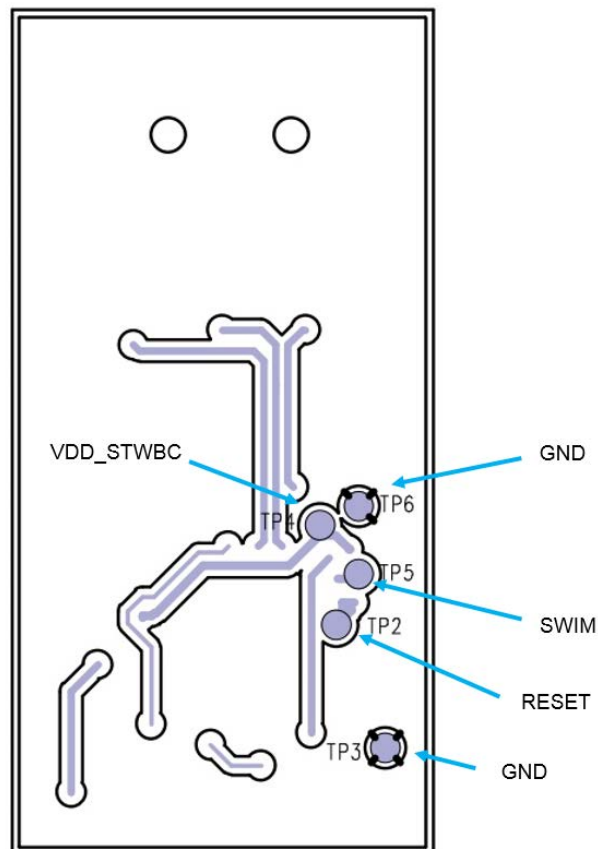
Figure 25. STVP configuration



- Step 1.** Power the target off
- Step 2.** Power the target on via a micro-USB cable to supply the board
- Step 3.** Connect ST-LINK circuit to the PC via USB

- Step 4.** Connect the ST-LINK–SWIM cable to the target so that SWIM, RESET, VDD_STWBC and GND signals are accessible on the STEVAL-ISB045V1T transmitter board test points (refer to the figure below for the wire identification: red for SWIM, yellow for RESET, orange for GND and brown for VDD_STWBC).

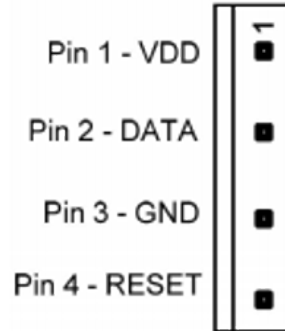
Figure 26. ST-LINK connection

Figure 27. SWIM connection

Table 5. SWIM flat ribbon connections for ST-LINK/V2

Pin no.	Name	Function	Target connection
1	VDD	Target VCC ⁽¹⁾	MCU VCC

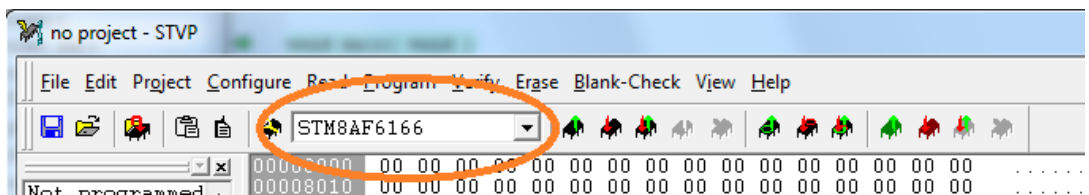
Pin no.	Name	Function	Target connection
2	DATA	SWIM	MCU SWIM pin
3	GND	GROUND	GND
4	RESET	RESET	MCU RESET pin

Figure 28. Target SWIM connector



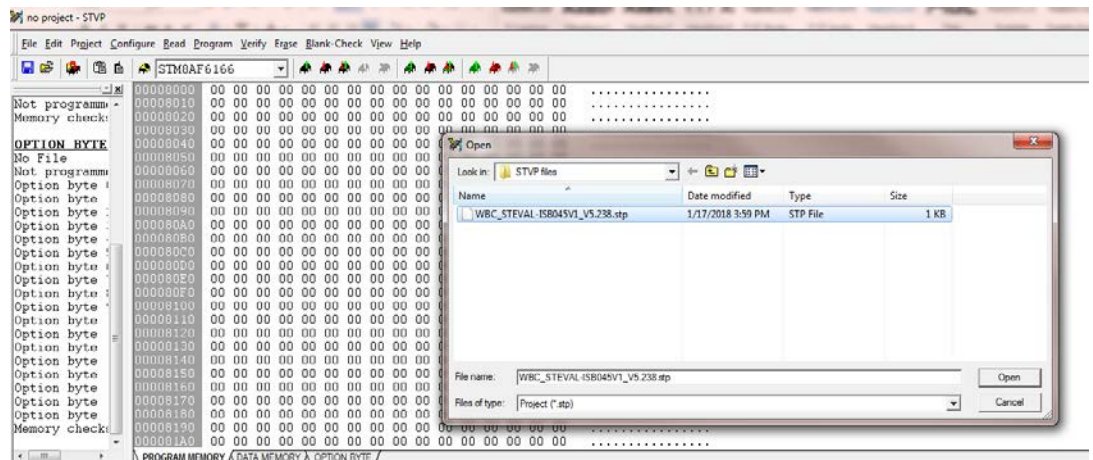
- Step 5. Launch STVP software
- Step 6. Select STM8AF6166 core

Figure 29. STVP core selection



- Step 7. In STVP, open the **Project** menu and click **Open**
- Step 8. Select the .stp given in the zip file

Figure 30. STVP file selection



Step 9. Wait a few seconds

The following message should appear:

```

Loading file program.hex in PROGRAM MEMORY area...
< File successfully loaded. File Checksum 0x1D1205
    
```

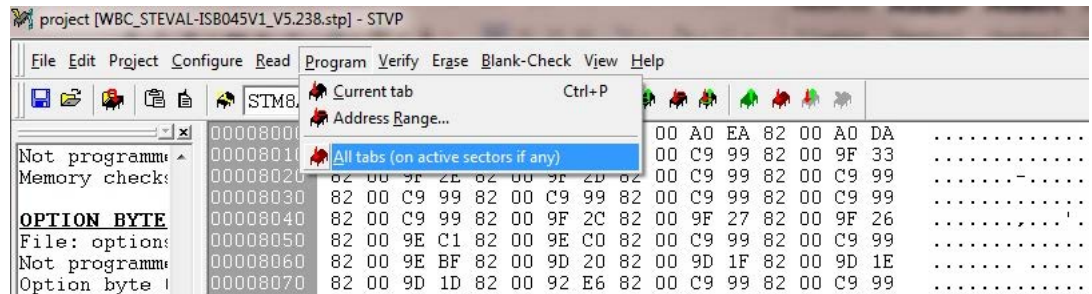
Note: It is normal that some warnings appear:

```

> Loading file options.hex in OPTION BYTE area...
FILE : line 2: Address 0x4802 is out of range and is ignored!
FILE : line 2: Address 0x4804 is out of range and is ignored!
    
```

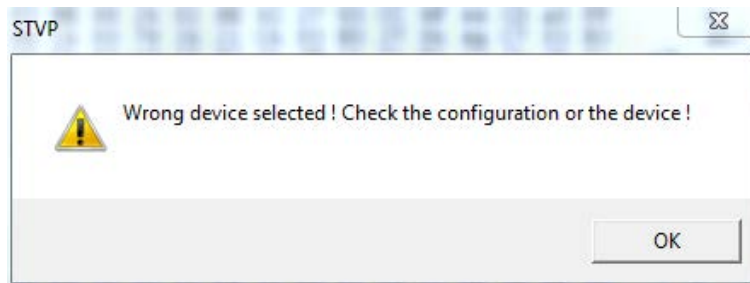
Step 10. In STVP, open the **Program** menu and select **All tabs (on active sectors, if any)**

Figure 31. STVP download



Step 11. Click OK if the following message appears

Figure 32. STVP wrong device selected alert



Step 12. Click Yes if the following message appears

Figure 33. STVP incompatibility device action query



Step 12. After this operation, the programming procedure starts. On completion, the following STVP message appears

```
< PROGRAM MEMORY programming completed.  
> Verifying PROGRAM MEMORY area...  
< PROGRAM MEMORY successfully verified.
```

Step 13. Exit from STVP program

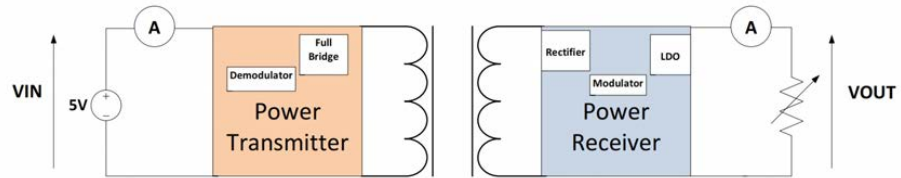
Step 14. Disconnect SWIM

Step 15. Power the STEVAL-ISB045V1T transmitter board off.

Step 16. Retry the UART download procedure if necessary.

4 Evaluation equipment setup

Figure 35. STEVAL-ISB045V1 evaluation kit: test setup configuration



The board is powered via the computer USB connector or via external power supply connection on VCC/GND test points. An electronic load is connected to the receiver output to load up to 2.5 W.

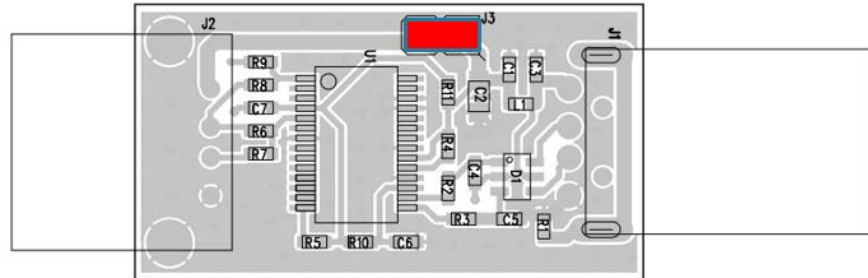
Voltmeters and ammeters measure input and output voltages and currents.

The [STSW-STWBCGUI](#) is installed on the PC which is connected to the board thanks to STEVAL-WBCDNGV1 dongle.

If the dongle is used to supply the transmitter board, the configuration can be:

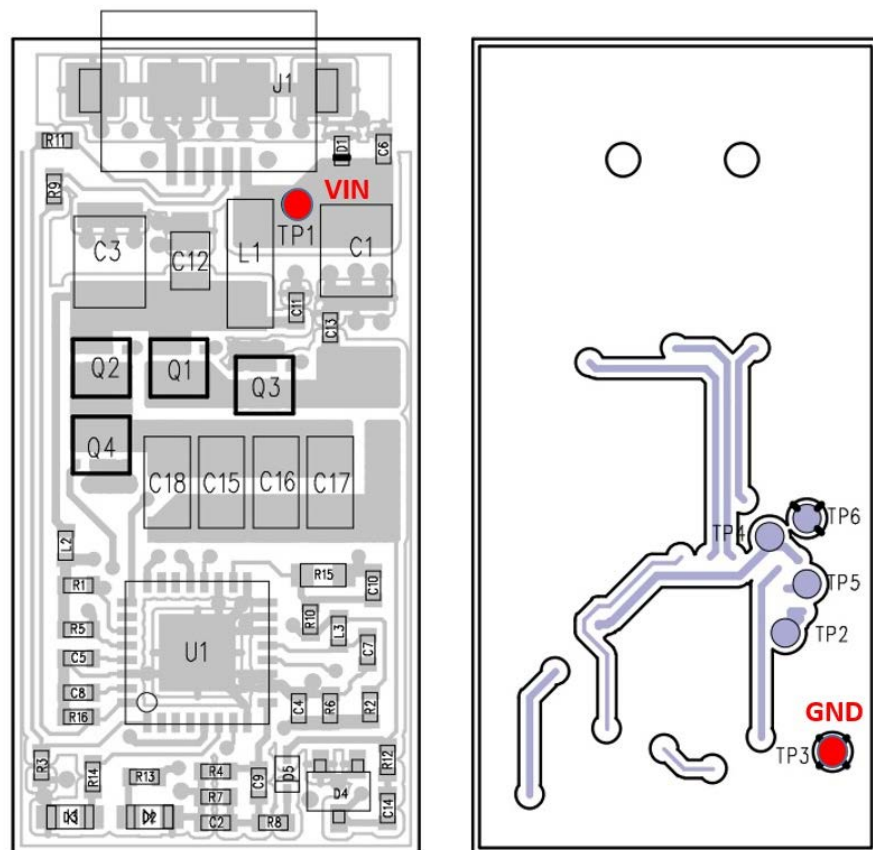
1. Computer USB supply (VBUS): ensure a jumper is set on J3 connector

Figure 36. Power supply via STEVAL-WBCDNGV1 dongle and PC VBUS



2. External power supply: no jumper has to be set on J3 connector. For instance, 5 V and GND wires can be soldered as shown below.

Figure 37. External power supply



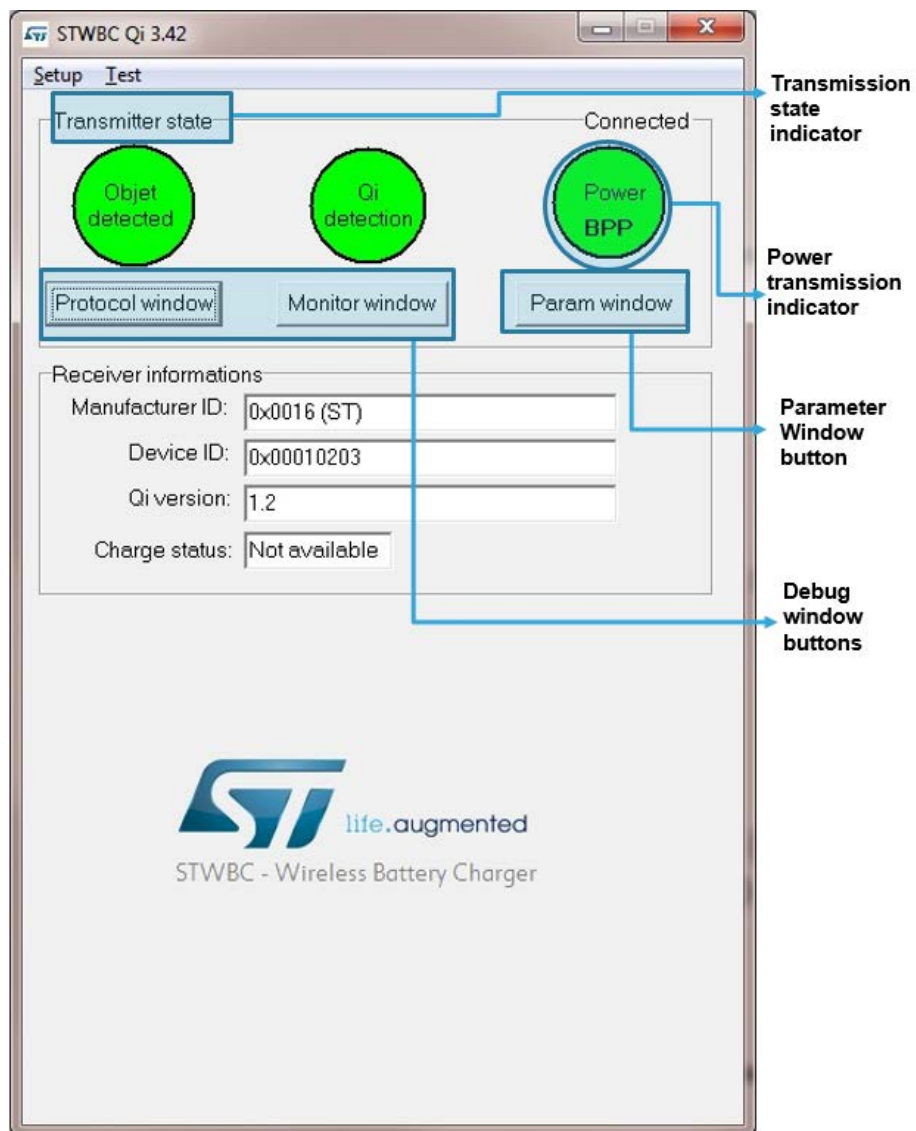
5 GUI and evaluation procedure

Refer to [Section 3.1 STSW-STWBCGUI software installation](#) to correctly install STSW-STWBCGUI and connect the STEVAL-ISB045V1 evaluation kit.

The STSW-STWBCGUI thoroughly monitors STWBC-WA operations.

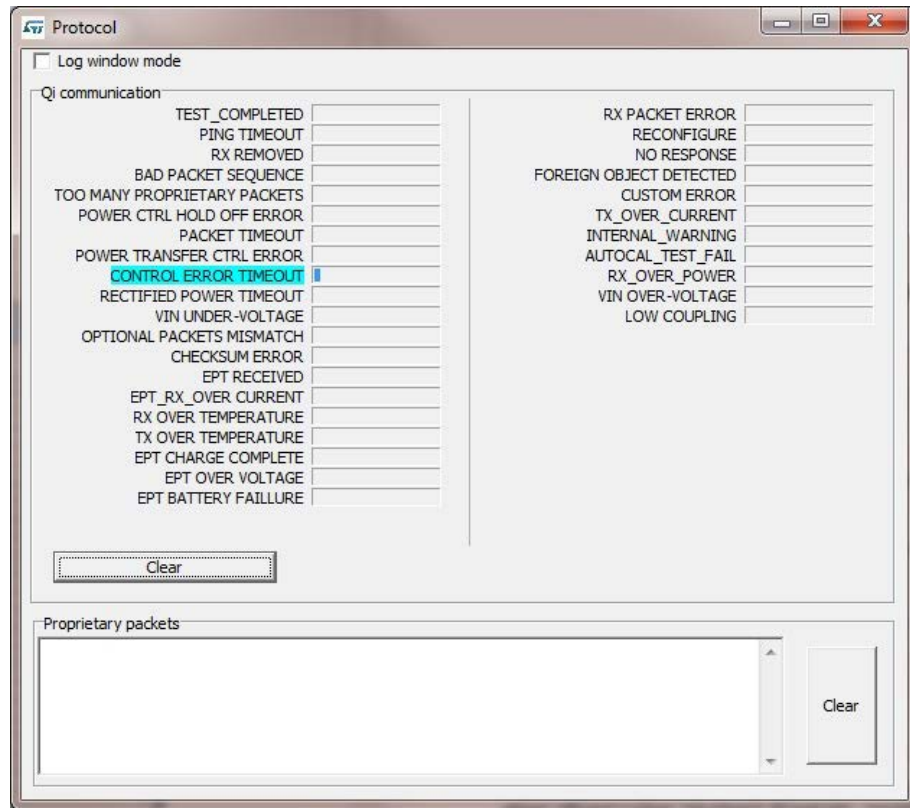
The main screen provides transmitter and Qi receiver status information.

Figure 38. STSW-STWBCGUI: object detected and charge in progress



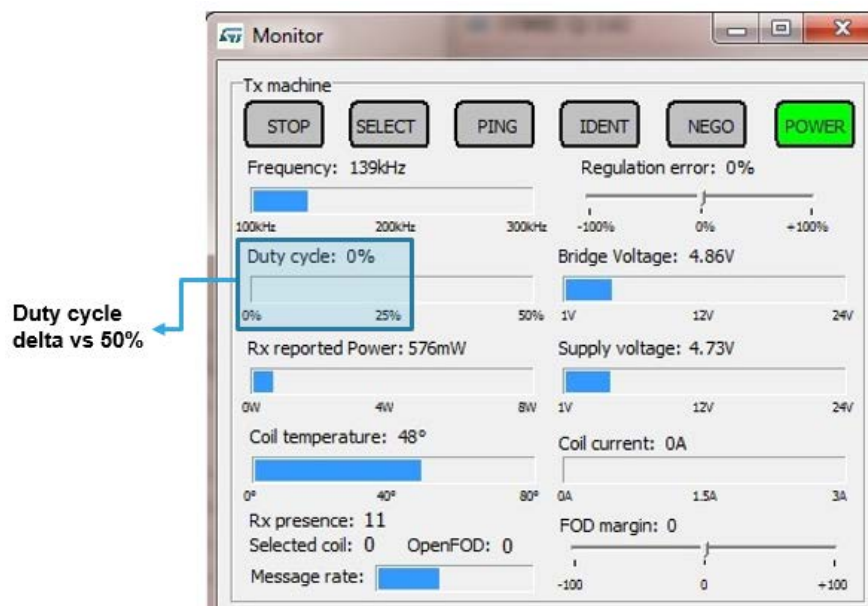
The STSW-STWBCGUI can also display the Rx to Tx communication protocol errors, useful for system debugging.

Figure 39. STSW-STWBCGUI: Qi protocol window



You can also monitor STWBC-WA internal variables such as bridge voltage and frequency, Rx reported power, coil temperature, etc.

Figure 40. STSW-STWBCGUI: monitor window

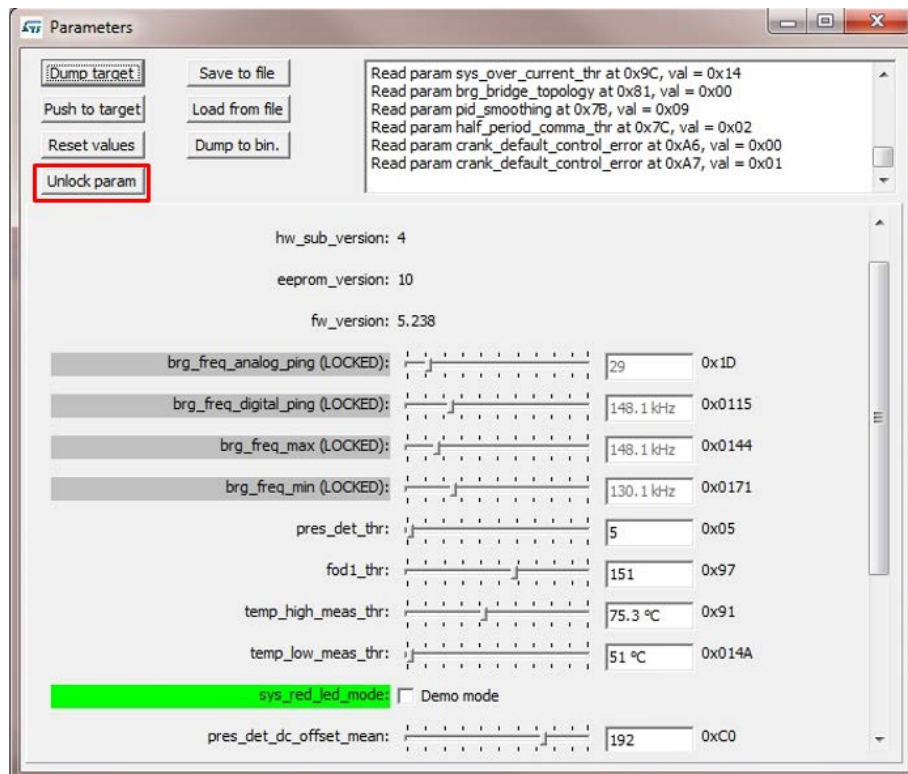


The GUI user-friendly interface allows efficient system adjustment (thresholds, regulation error) and lets you store parameters to and load parameters from your computer.

The parameters have the following levels of protection:

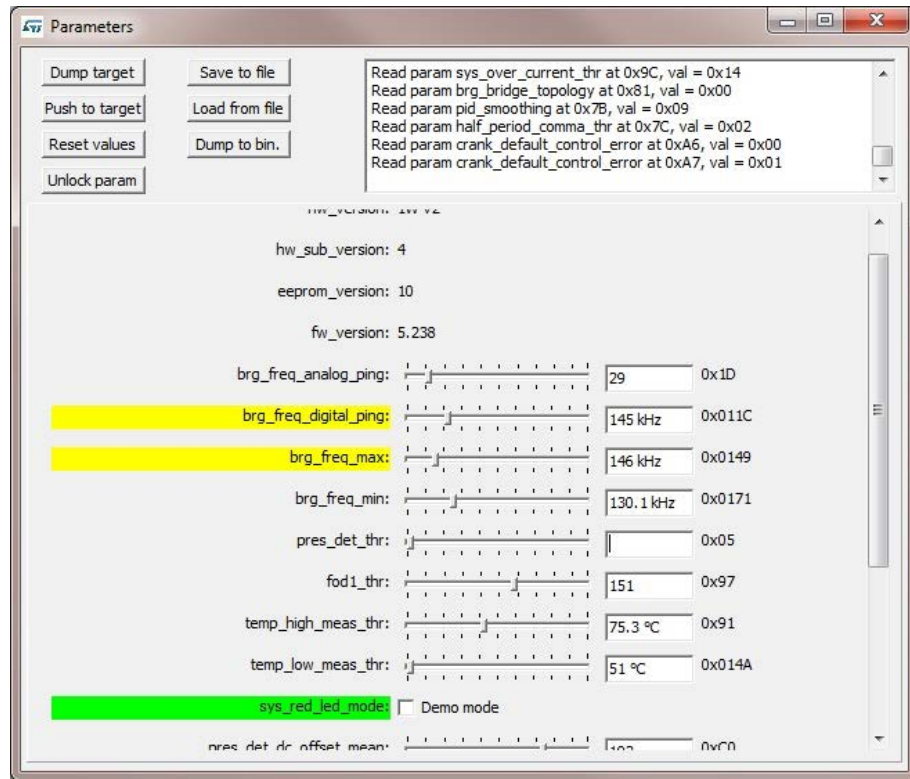
- Level 0: parameters can be modified without protection
- Level 1: more critical parameters to be modified with caution. You must click the **Unlock param** button before modifying it, with caution, as it can lead to system malfunction or trigger unexpected behavior.

Figure 41. STSW-STWBCGUI: parameter window



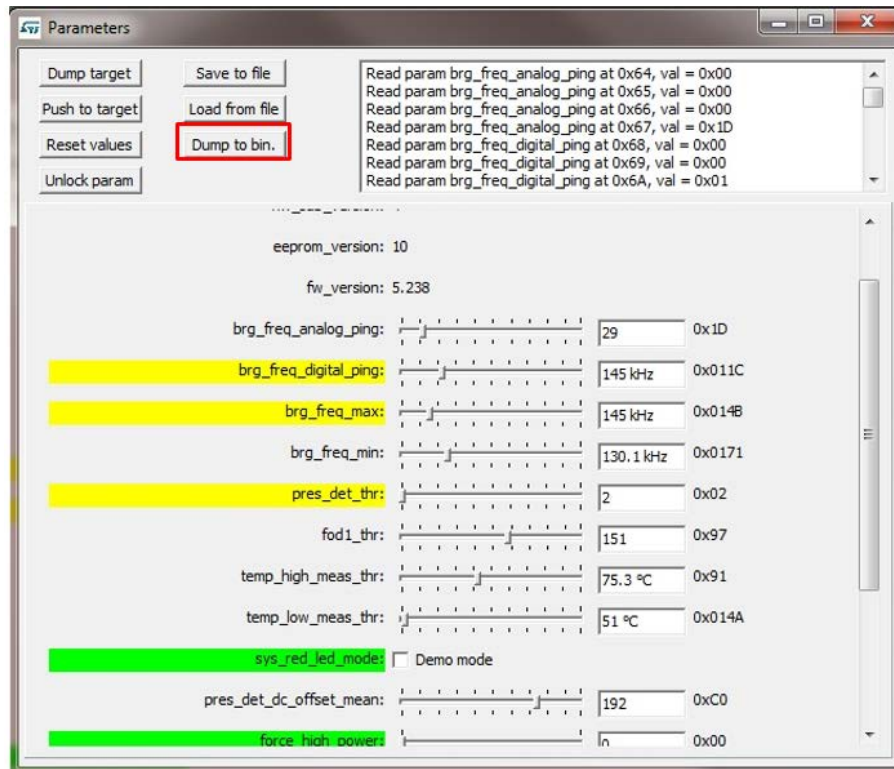
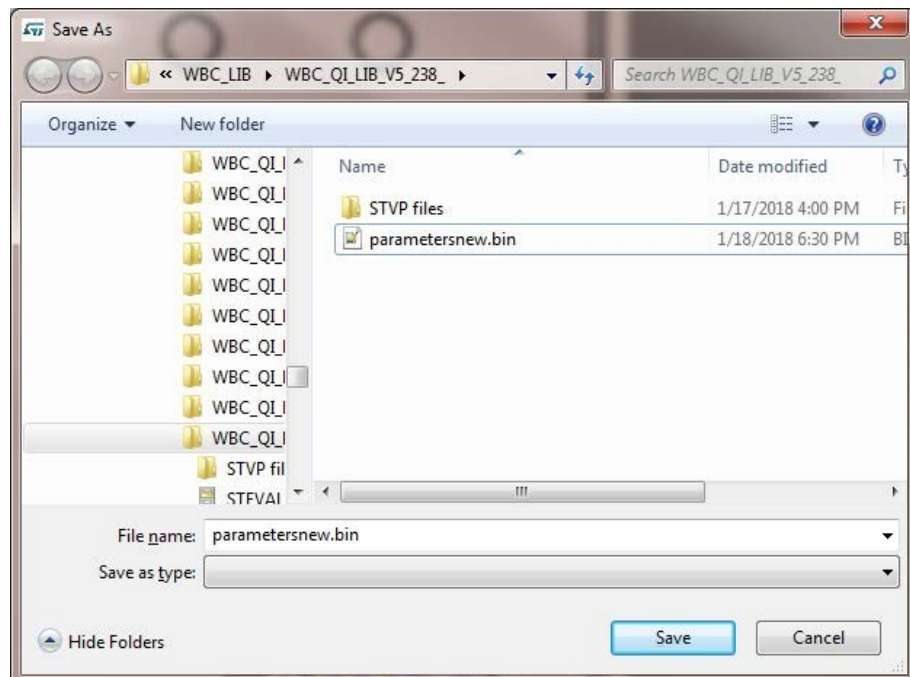
Parameters can be modified and their effect can be tested immediately by clicking **Push to target**; you can double check the parameter modification by clicking on **Dump target** button.

Figure 42. STSW-STWBCGUI: parameter modification



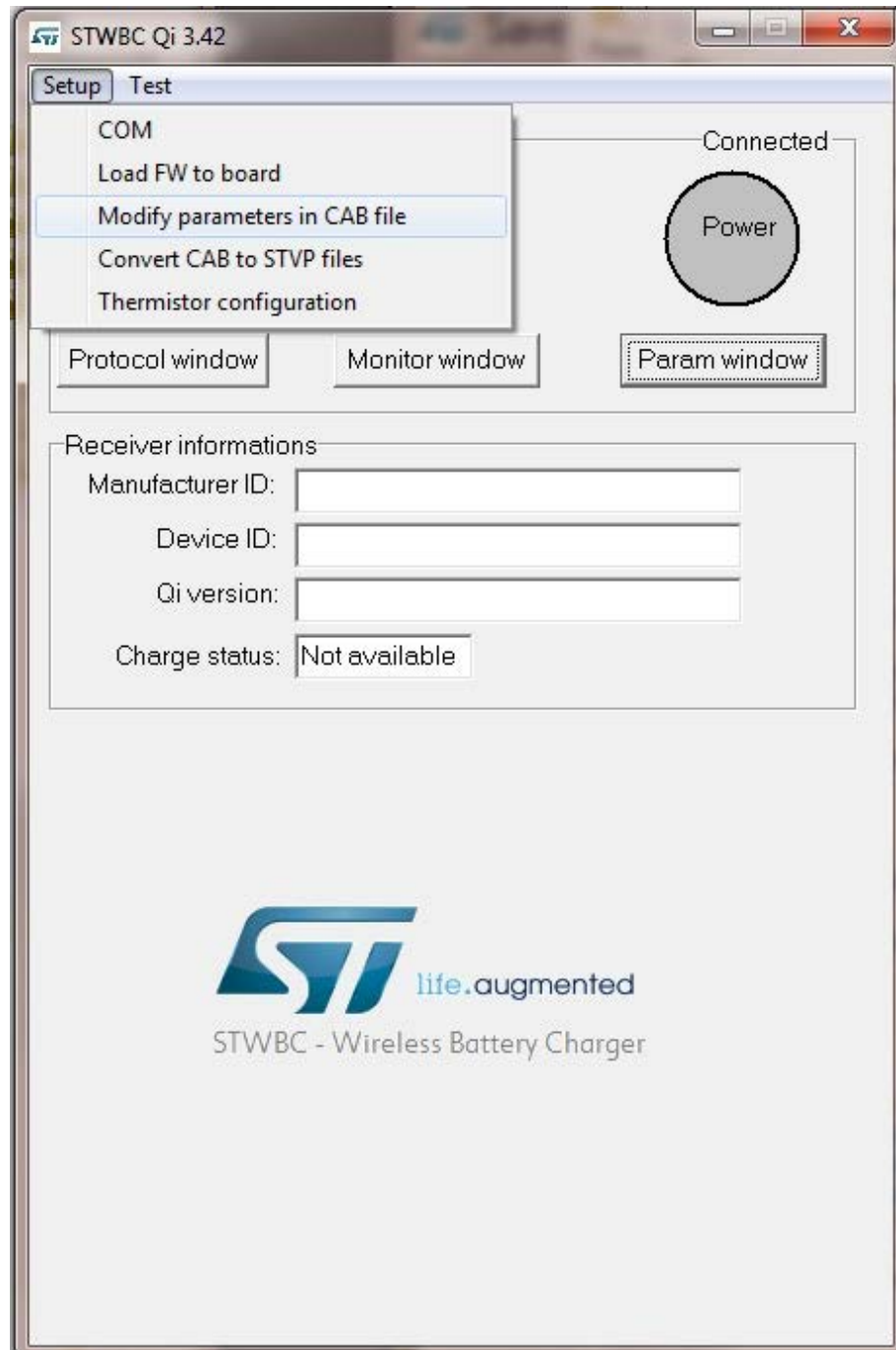
The GUI embeds the [STSW-STWBCFWD](#) downloader interface (which uses UART connection) and includes tools to generate binary files with adjusted parameters and to build new firmware packages incorporating these files.

Through the GUI, you can change the parameters and produce a new cab to program a batch of new boards. To do so, dump the parameters into a bin file, but only after clicking the **Push to target** button.

Figure 43. STSW-STWBCGUI: saving modified parameters (Dump to bin)

Figure 44. STSW-STWBCGUI: bin file backup


You can then select **Modify parameters in CAB file** from the setup menu and select the appropriate firmware CAB file to be patched. This operation will alter the firmware file with new tuning parameters, which can be subsequently loaded using the standard procedure.

Figure 45. STSW-STWBCGUI: CAB file patch button



5.1 Status LEDs

The status LEDs give the state of the charge:

At startup

- Red short blinking: when the board auto-calibration is on-going. You have to wait for the LED to be switched off before putting a receiver on the surface.
- Red and green blinking once: an internal reset occurred.
- Red and green steady state: firmware/STWBC chip mismatch
- Red steady and after 2 seconds green steady state: board hardware subversion detected does not match the firmware

In steady state

- Green blinking: power transfer in progress
- Green steady state: the charge is complete
- Red blinking: an error has been detected, as incomplete charge due to battery fault, overvoltage, overcurrent, etc.
- Red steady state: the transmitter is stuck until the receiver is removed, as mentioned in the Qi standard (power transfer stopped three times in a row due to the amount of power not provided to the receiver, some types of end power transfer or no response error code)

5.2 Presence detection calibration procedure

This auto-calibration is necessary in the [STSW-STWBCGUI](#) for the presence detection algorithm and is mandatory to ensure a correct functioning of the STEVAL-ISB045V1T transmitter board.

Important: This calibration is mandatory after each new firmware download.

- Step 1.** Start the calibration only once after a new firmware download, without placing the receiver on the transmitter

Figure 46. STSW-STWBCGUI auto-calibration start

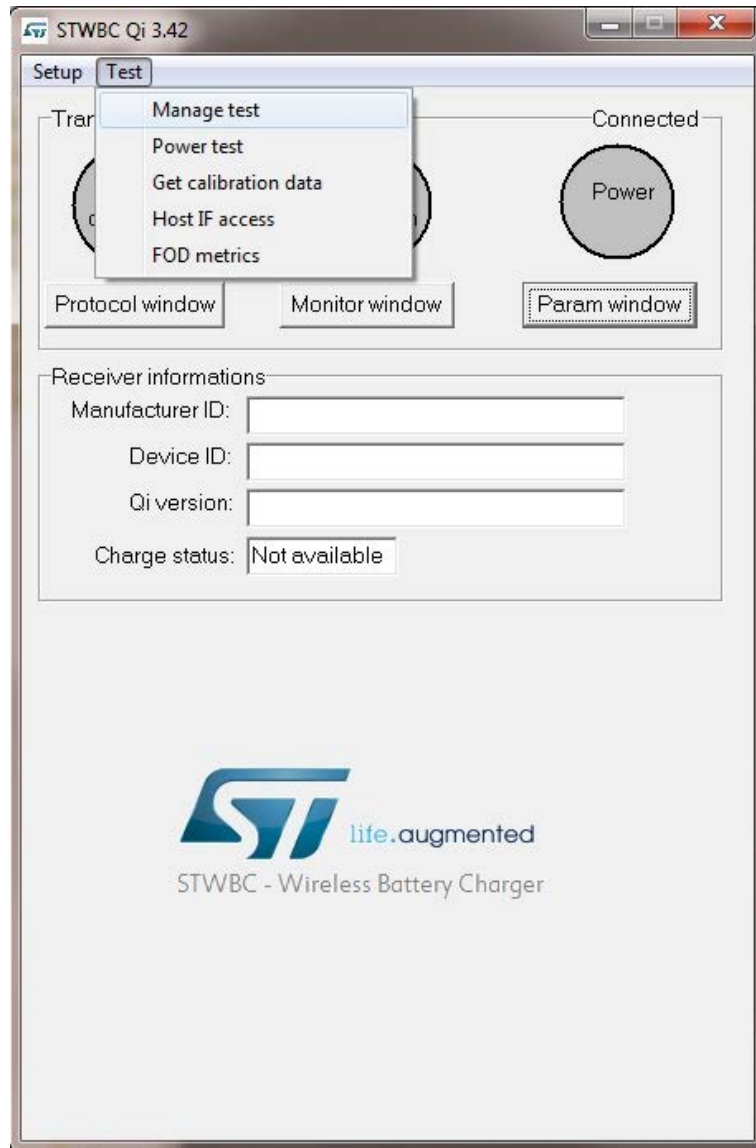


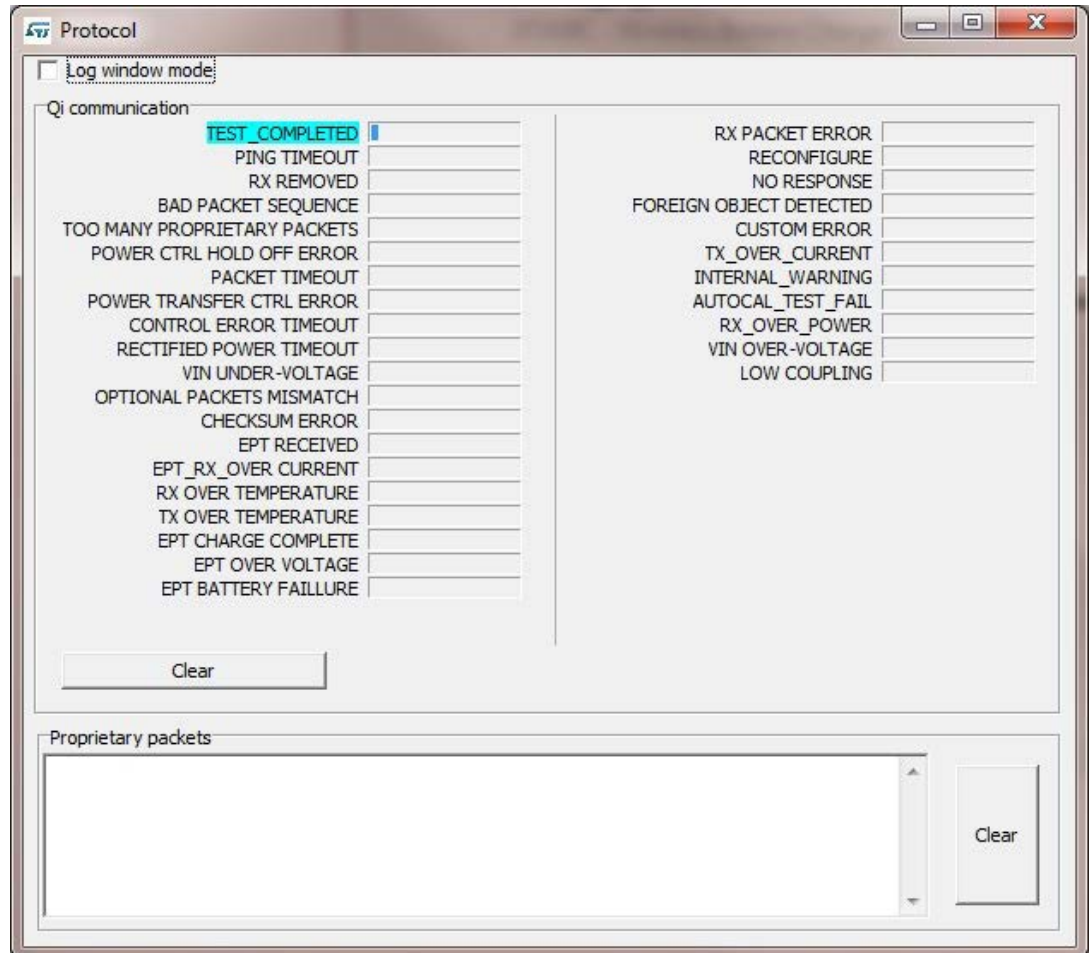
Figure 47. STSW-STWBCGUI presence detection test



Once the calibration is done, a status bit is set in the chip.

Step 2. Use the protocol window to check if **test completed** has been set (which means the calibration was successful).

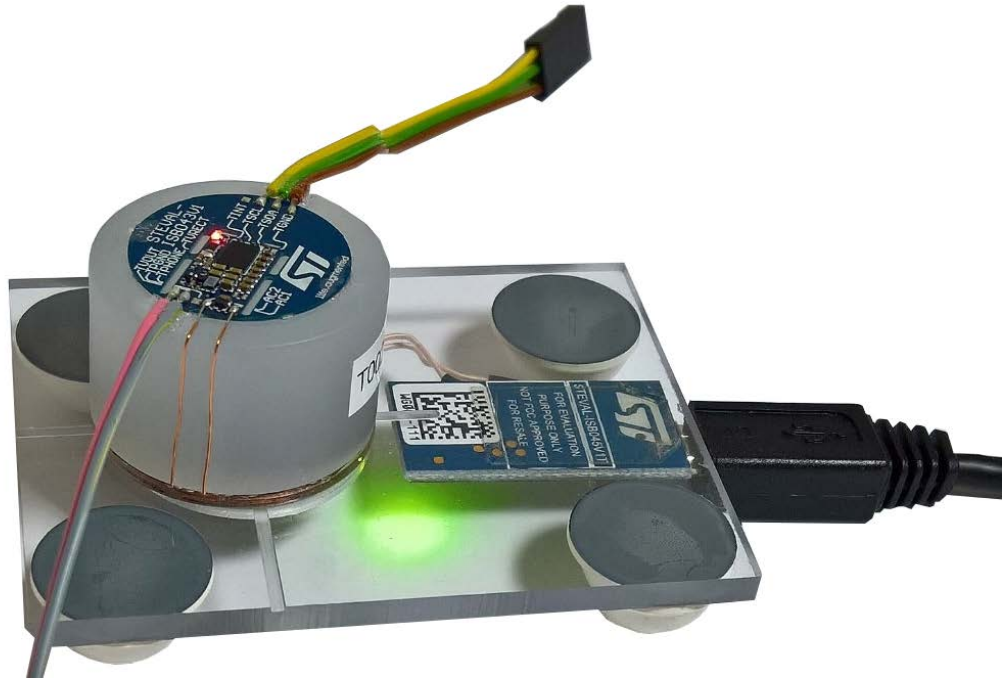
Figure 48. STSW-STWBCGUI presence detection calibration check



5.3 Efficiency

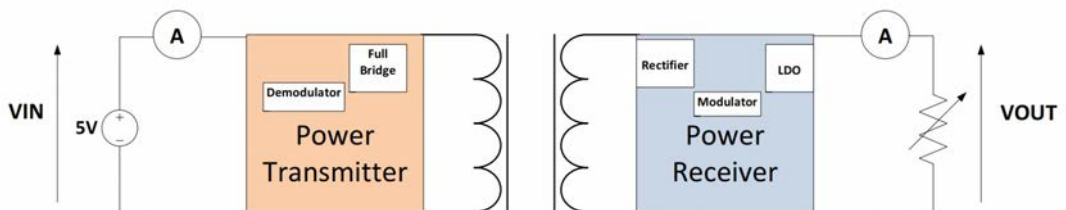
Efficiency measurements are performed connecting the STEVAL-ISB045V1T transmitter board with the 2.5 W STEVAL-ISB043V1 receiver.

Figure 49. STEVAL-ISB045V1T test setup



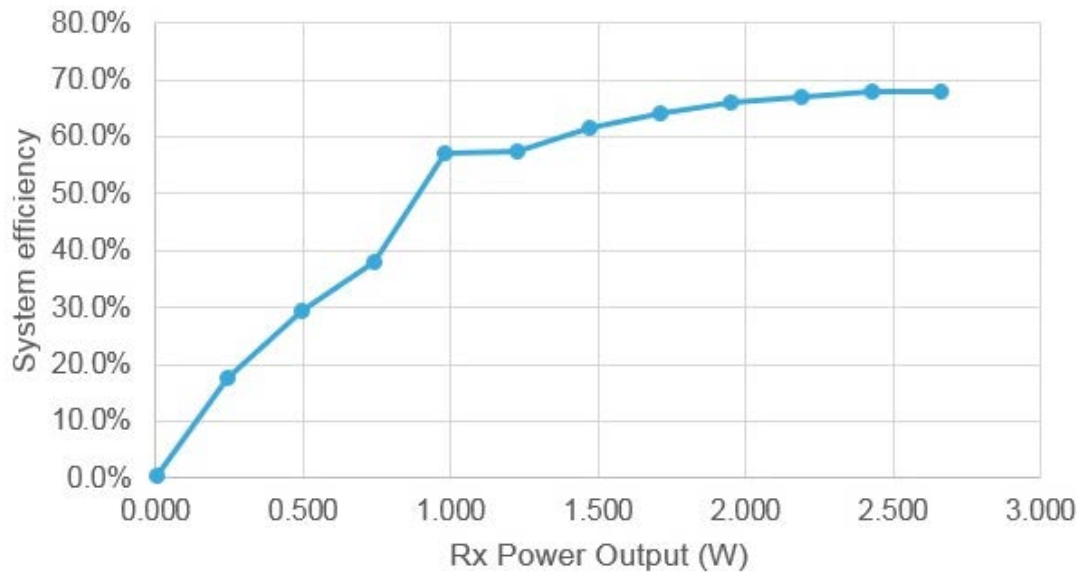
The STEVAL-ISB045V1T transmitter board is supplied by 5 V/1 A and the receiver voltage level is 5 V. P_{OUT} is the output power actually measured at the receiver output (not only at the rectifier output) and P_{IN} is the input power.

Figure 50. Efficiency setup



The figure below shows the typical performance of the kit coils (efficiency= P_{OUT}/P_{IN}).

Figure 51. STEVAL-ISB045V1 evaluation board: efficiency vs output power



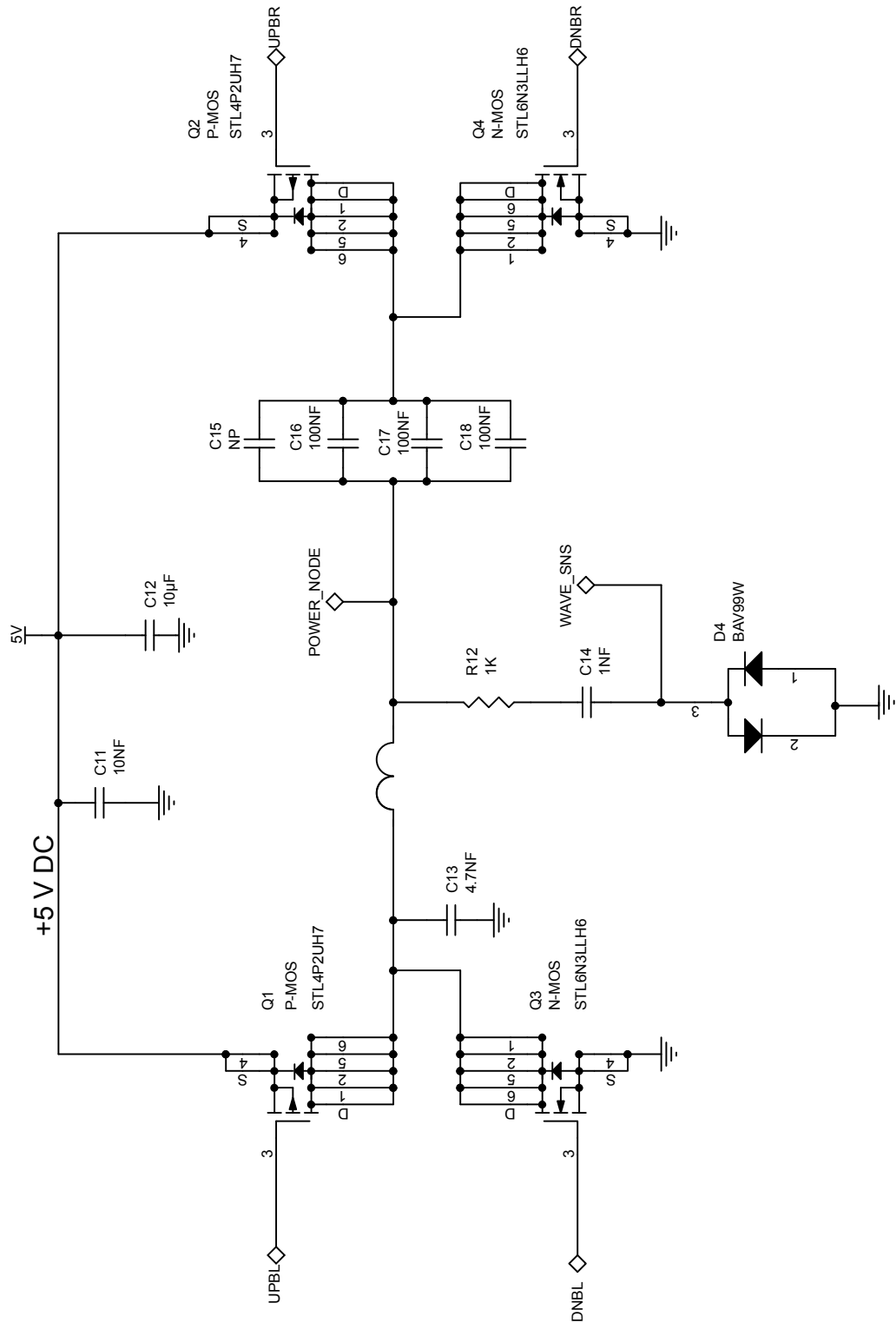
5.4 Standby consumption

In standby, when the board is supplied at 5 V, very low power consumption is achieved.

In this mode, device detection is still ensured; power consumption is reduced down to 320 μ A average, thus a low standby power of only 1.6 mW.

Note: To measure this low power consumption, the UART cable must be unplugged.

Figure 53. STEVAL-ISB045V1T circuit schematic (2 of 3)



Layout note : GND plan dedicated to the bridge and the power supply connector

Figure 54. STEVAL-ISB045V1T circuit schematic (3 of 3)

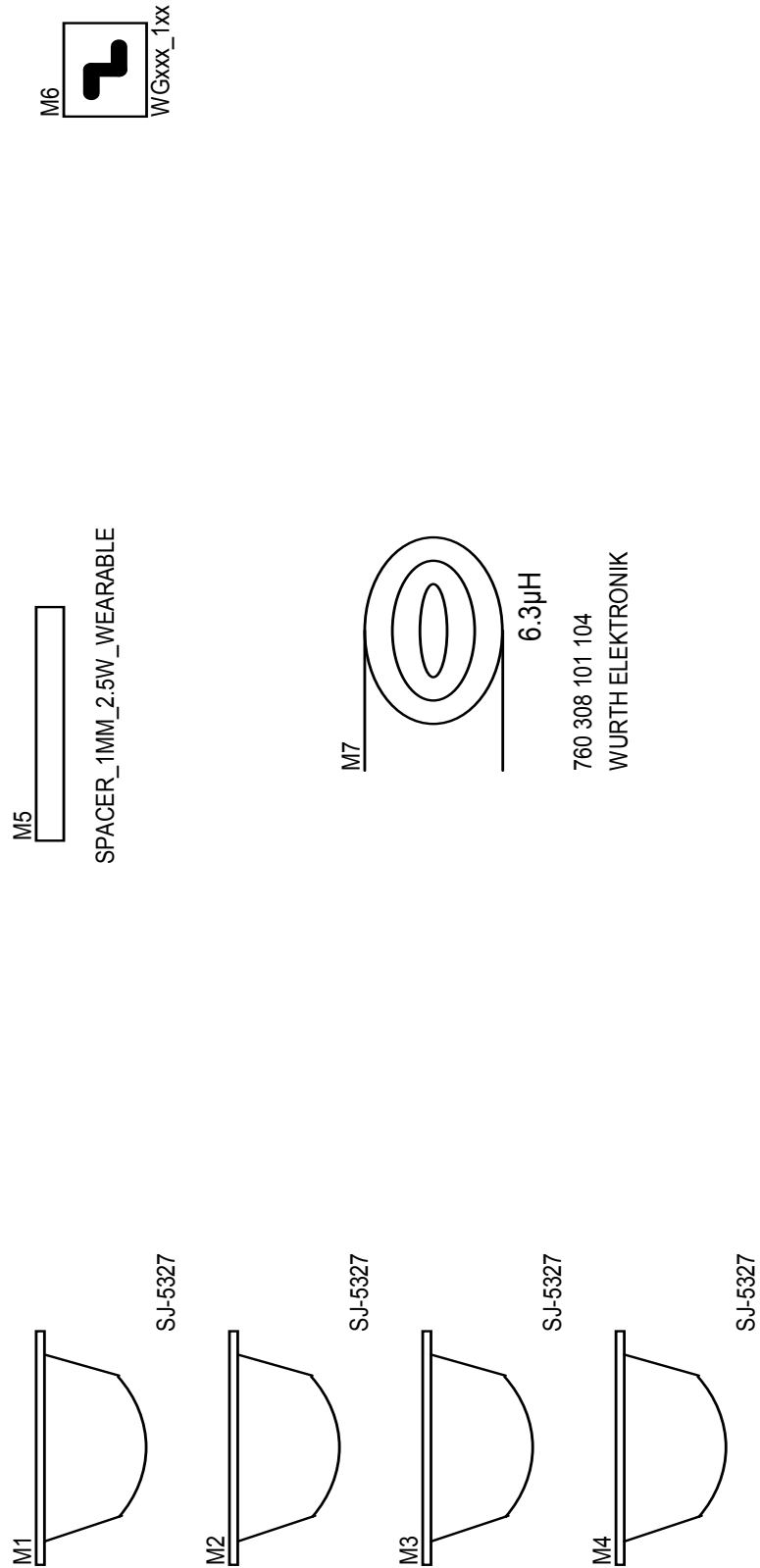
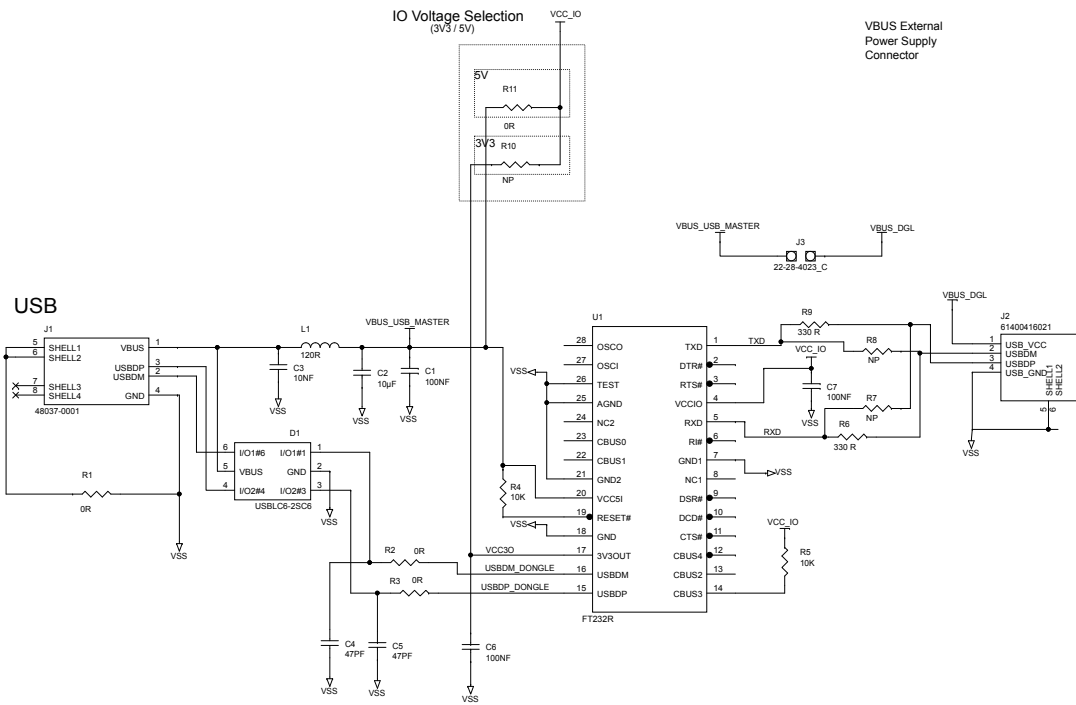


Figure 55. STEVAL-WBCDNGV1 circuit schematic


7 Bill of materials

Table 6. STEVAL-ISB045V1T bill of materials

Item	Q.ty	Ref.	Part/Value	Description	Manufacturer	Order code
1	2	C1, C3	47 μ F 16 V \pm 20% 1210	Ceramic capacitors	Murata	GRM32ER61C476ME15
2	2	C2, C13	4.7 NF 50 V \pm 15% 402	Ceramic capacitors	Any	4.7NF_50V_X7R_0402
3	4	C4, C9, C10, C11	10 NF 50 V \pm 15% 402	Ceramic capacitors	Any	10NF_50V_X7R_0402
4	3	C5, C6, C7	100 NF 50 V \pm 15% 402	Ceramic capacitors	Any	100NF_50V_X5R_0402
5	1	C8	1 μ F 16 V \pm 1% 402	Ceramic capacitor	Any	1UF_16V_X5R_0402
6	1	C12	10 μ F 10 V \pm 1% 805	Ceramic capacitor	Murata	GRM21BR71A106KE51L
7	1	C14	1 NF 50 V \pm 15% 402	Ceramic capacitor	Any	1NF_50V_X5R_0402
8	1	C15	NP 1206	Ceramic capacitor	Any	C_NP_1206
9	3	C16, C17, C18	100 NF 50 V \pm 5% 1206	Ceramic capacitors	Murata	GRM31C5C1H104JA01L
10	1	D1	ESDA7P60-1U1M L1.55_W0.95_H0.53	High-power transient voltage suppressor (TVS)	ST	ESDA7P60-1U1M
11	1	D2	RED 603	LED	Würth Elektronik	150060RS75000
12	1	D3	GREEN 603	LED	Würth Elektronik	150060VS75000
13	1	D4	BAV99W SOT323	Diode	NXP	BAV99W
14	1	D5	BAS516 DIOD_SOD523	Diode	Any	BAS516
15	1	J1	629105136821	USB	Würth Elektronik	629105136821
16	1	L1	180R 3 A \pm 25% 1806	Ferrite	Murata	BLM41PG181SN1
17	1	L2	0.27 μ H 0.11 A \pm 5% 402	Inductor	Taiyo Yuden	HK1005R27J-T
18	1	L3	1 K 0.2 A \pm 25% 402	Ferrite	Murata	BLM15AG102SN1D
19	4	M1, M2, M3, M4	SJ-5327 transparent	Spacer	3M	SJ-5327 (Transparent)
20	1	M5	SPACER_1MM_2.5W_WEARABLE	Spacer	Any	SPACER_1MM_2.5W_WEARABLE
21	1	M6	WGxxx_1xx	PCB	Any	PCB WG - 2 layers
22	1	M7	6.3 μ H 2.5 A D55	Inductor	Würth Elektronik	760 308 101 104
23	2	Q1, Q2	P-MOS L2_W2_H0.75	P-channel Power MOSFET	ST	STL4P2UH7

Item	Q.ty	Ref.	Part/Value	Description	Manufacturer	Order code
24	2	Q3, Q4	N-MOS L2_W2_H0.75	N-channel 30 V, 0.021 Ohm typ., 6 A STripFET H6 Power MOSFET	ST	STL6N3LLH6
25	4	R1, R3, R7, R16	100 K 1/16 W ±5% 402	Resistors	Any	100K_5%_0402
26	1	R2	220 K 1/16 W ±1% 402	Resistor	Any	220K_1%_0402
27	1	R4	220 K 1/16 W ±5% 402	Resistor	Any	220K_5%_0402
28	1	R5	10 K 1/16 W ±5% 402	Resistor	Any	10K_5%_0402
29	1	R6	47 K 1/16 W ±1% 402	Resistor	Any	47K_1%_0402
30	1	R8	4.7 K 1/16 W ±5% 402	Resistor	Any	4.7K_5%_0402
31	2	R9, R11	0 R 1/16 W ±5% 402	Resistors	Any	0R_5%_0402
32	1	R10	180 K 1/16 W ±5% 402	Resistor	Any	180K_5%_0402
33	1	R12	1 K 1/16 W ±5% 402	Resistor	Any	1K_5%_0402
34	2	R13, R14	470 R 1/16 W ±5% 402	Resistors	Any	470R_5%_0402
35	1	R15	47 K 1/10 W ±5% 603	Resistor	Murata	NCP18WB473J03RB
36	6	TP1, TP2, TP3, TP4, TP5, TP6	TPSMD-1MM Test Point	Test point	Any	TPSMD-1MM
37	1	U1	STWBC-WA QFN32	Digital controller for wireless battery charger transmitters for wearable and smart watches applications	ST	STWBC-WA

Table 7. STEVAL-WBCDNGV1 bill of materials

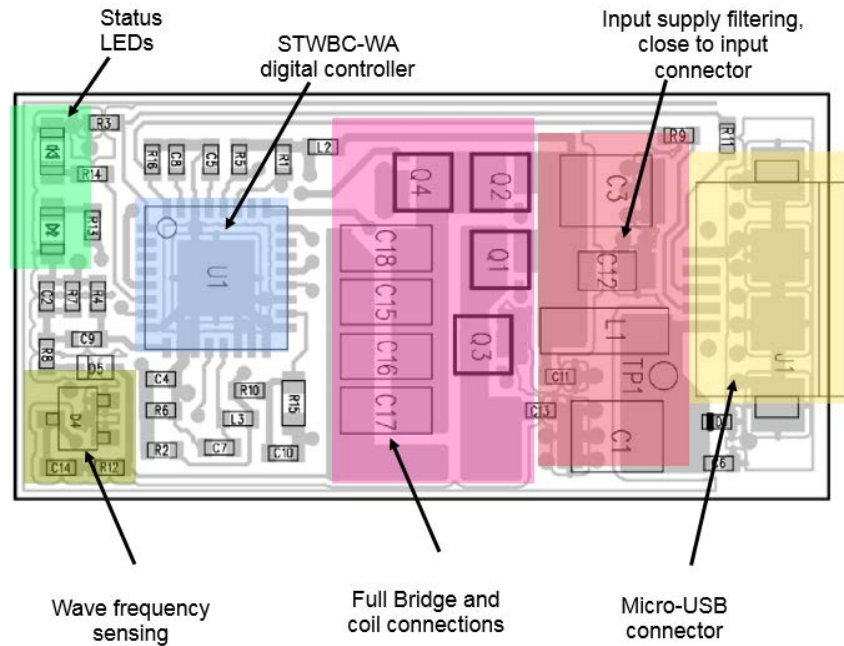
Item	Q.ty	Ref.	Part/Value	Description	Manufacturer	Order code
1	3	C1, C6, C7	100 NF 50 V ±15% 603	Ceramic capacitors	Any	100NF_50V_X7R_0603
2	1	C2	10 µF 25 V ±10% 805	Ceramic capacitor	Any	10UF_25V_X7R_0805
3	1	C3	10 NF 50 V ±15% 603	Ceramic capacitor	Any	10NF_50V_X7R_0603
4	2	C4, C5	47 PF 25 V 0.15 603	Ceramic capacitors	Any	47PF_25V_X5R_0603
5	1	D1	USBL6-2SC6 SOT23-6L	Very low capacitance ESD protection	ST	USBL6-2SC6
6	1	J1	48037-0001	USB	Molex	48037-0001
7	1	J2	61400416021	USB	Würth Elektronik	61400416021
8	1	J3	22-28-4023_C JUMP254P-M-2	Header	Molex	22-28-4023_C
9	1	L1	120 R 0.5 A ±25% 603	Ferrite	Würth Elektronik	74279262

Item	Q.ty	Ref.	Part/Value	Description	Manufacturer	Order code
10	4	R1, R2, R3, R11	0 R 1/10 W $\pm 5\%$ 603	Resistors	Any	0R_5%_0603
11	2	R4, R5	10 K 1/10 W $\pm 5\%$ 603	Resistors	Any	10K_5%_0603
12	2	R6, R9	330 R 1/10 W $\pm 5\%$ 603	Resistors	Any	330R_5%_0603
13	3	R7, R8, R10	NP 603	Resistors	Any	R_NP_0603
14	1	U1	FT232R SSOP28	Converter	FTDI	FT232R

8 STEVAL-ISB045V1T transmitter board assembly and layout

The evaluation board has been designed using a low cost 2-layer PCB with all the components on the same side. The UART is accessible through a micro-USB connector and SWIM signals are accessible on the test points.

Figure 56. STEVAL-ISB045V1T transmitter main blocks



To ensure correct functioning, you have to follow some design rules for the board assembly.

As the current flowing in the board can be large, many vias must be used to route the 5 V and the power GND from top to bottom.

Large track or plane should be used for power GND, 5 V supply voltage and LC power node.

Figure 57. STEVAL-ISB045V1T transmitter: V_{IN} and 5 V power signal routing

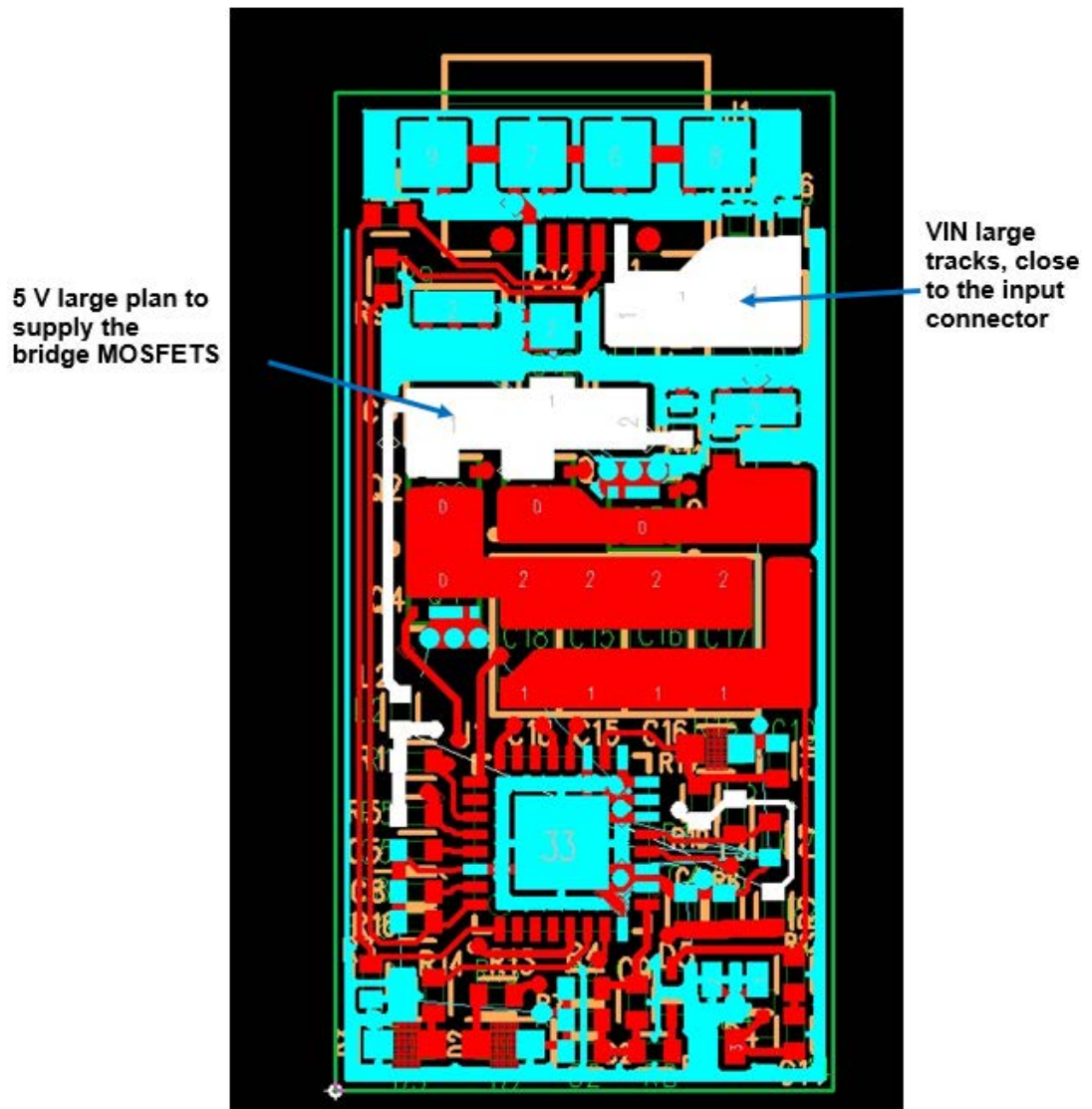
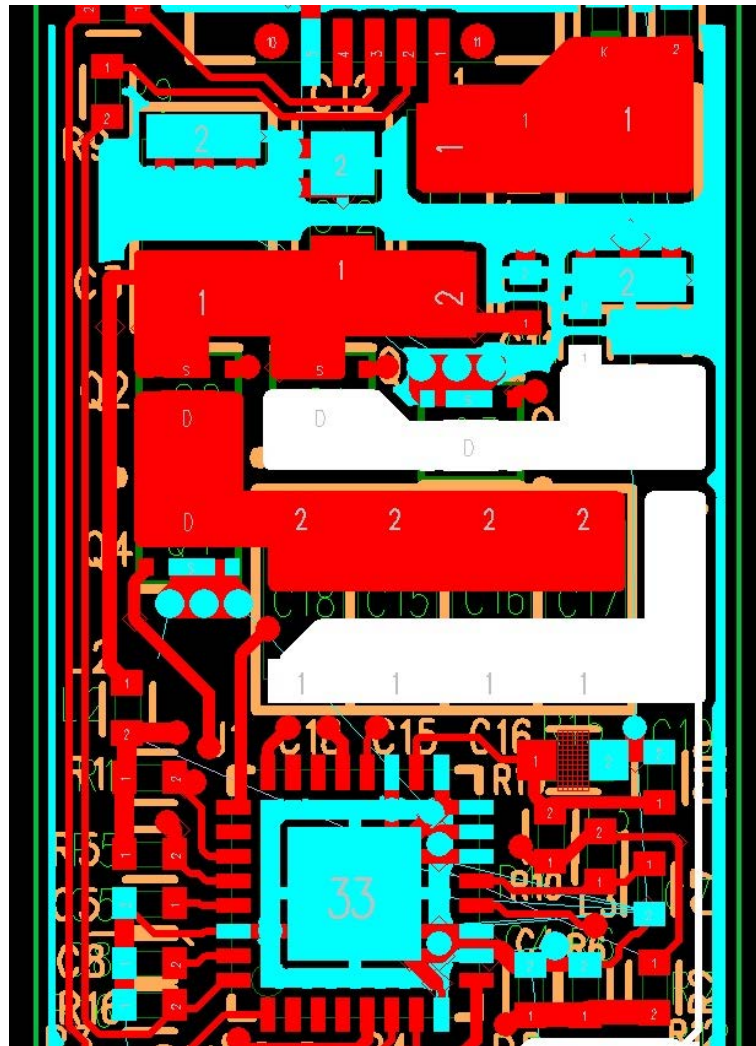
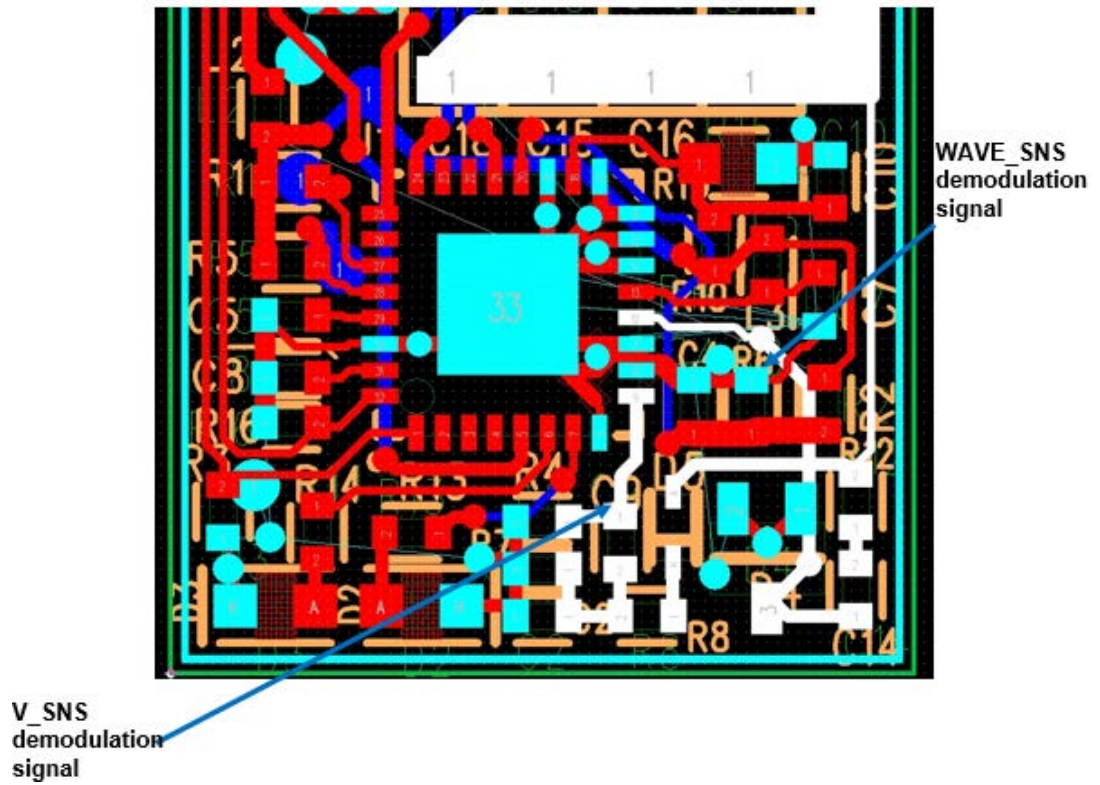


Figure 59. STEVAL-ISB045V1T transmitter: large tracks for wireless power coil connection



The layout must also be clean on the demodulation signals (V_SNS, WAVE_SNS) to avoid any coupling with the switching of the power bridge (Power_node and UPBL/DNBL/UPBR, DNBR signals).

Figure 60. STEVAL-ISB045V1T transmitter: large tracks for wireless power coil connection (zoom)



Appendix A References

Freely available at www.st.com:

1. Datasheet (DS11797): STWBC-WA – Digital controller for wireless battery charger transmitters for wearable and smartwatch applications.
2. Databrief (DB3531): STEVAL-ISB045V1 - 2.5 W wireless charger transmitter evaluation kit
3. User manual (UM2368): STWBC 2.5 W turnkey firmware description
4. Databrief (DB3410): STSW-STWBCFWDT - STWBC firmware downloader tool

Revision history

Table 8. Document revision history

Date	Version	Changes
13-Mar-2018	1	Initial release.
14-May-2018	2	Updated Section 5.4 Standby consumption.
26-Aug-2019	3	Updated Section 3.3.2 Firmware download with blank chip.

Contents

1	Getting started	2
1.1	System requirements	2
1.2	Package contents	2
2	Hardware description and setup	3
2.1	System block diagram	3
2.2	STEVAL-ISB045V1 wireless transmitter kit overview	3
2.3	STWBC-WA pinout and pin description	7
3	Download procedure	10
3.1	STSW-STWBCGUI software installation	10
3.2	Firmware download via STSW-STWBCGUI	11
3.2.1	Download procedure with a new chip (never been programmed)	11
3.2.2	Firmware upgrade procedure (chip already programmed)	14
3.3	Firmware download with command line (UART)	15
3.3.1	Firmware download with written chip	15
3.3.2	Firmware download with blank chip	15
3.4	STVP file creation	16
3.5	Firmware download with STVP	17
3.6	Erasing firmware procedure using STVP	22
4	Evaluation equipment setup	24
5	GUI and evaluation procedure	26
5.1	Status LEDs	31
5.2	Presence detection calibration procedure	32
5.3	Efficiency	35
5.4	Standby consumption	37
6	STEVAL-ISB045V1 schematic diagrams	38
7	Bill of materials	42
8	STEVAL-ISB045V1T transmitter board assembly and layout	45
Appendix A	References	50
	Revision history	51

List of tables

Table 1.	STEVAL-ISB045V1T electrical performance	4
Table 2.	STEVAL-ISB045V1T evaluation board: connector and test points	6
Table 3.	STEVAL-WBCDNGV1 connectors	7
Table 4.	STWBC-WA pin description	8
Table 5.	SWIM flat ribbon connections for ST-LINK/V2	19
Table 6.	STEVAL-ISB045V1T bill of materials	42
Table 7.	STEVAL-WBCDNGV1 bill of materials	43
Table 8.	Document revision history	51

List of figures

Figure 1.	STEVAL-ISB045V1 evaluation kit	1
Figure 2.	STWBC-WA block diagram	3
Figure 3.	STEVAL-ISB045V1T evaluation board: components	4
Figure 4.	STEVAL-ISB045V1T evaluation board: top reference designators	5
Figure 5.	STEVAL-ISB045V1T evaluation board: bottom reference designators (TP for SWIM connection)	6
Figure 6.	STEVAL-WBCDNGV1 dongle components.	7
Figure 7.	STEVAL-WBCDNGV1: top reference designators	7
Figure 8.	STWBC-WA pinout configuration	8
Figure 9.	STSW-STWBCGUI installation file	10
Figure 10.	Windows Device Manager: COM port selection.	10
Figure 11.	STSW-STWBCGUI start screen	11
Figure 12.	Dongle connection	12
Figure 13.	Firmware download with STSW-STWBCGUI	12
Figure 14.	Firmware file selection	13
Figure 15.	Power on message	13
Figure 16.	STEVAL-ISB045V1 evaluation kit connection	13
Figure 17.	DOS window: download in progress	14
Figure 18.	Download success message	14
Figure 19.	STSW-STWBCGUI command line.	15
Figure 20.	STSW-STWBCGUI command line with blank chip.	16
Figure 21.	STSW-STWBCGUI: convert CAB to STVP files	16
Figure 22.	Selecting the CAB file to be converted	17
Figure 23.	Selecting the STVP project file name.	17
Figure 24.	STVP project files	17
Figure 25.	STVP configuration	18
Figure 26.	ST-LINK connection	19
Figure 27.	SWIM connection	19
Figure 28.	Target SWIM connector	20
Figure 29.	STVP core selection	20
Figure 30.	STVP file selection	20
Figure 31.	STVP download	21
Figure 32.	STVP wrong device selected alert.	21
Figure 33.	STVP incompatibility device action query	21
Figure 34.	STVP download	22
Figure 35.	STEVAL-ISB045V1 evaluation kit: test setup configuration	24
Figure 36.	Power supply via STEVAL-WBCDNGV1 dongle and PC VBUS.	25
Figure 37.	External power supply	25
Figure 38.	STSW-STWBCGUI: object detected and charge in progress.	26
Figure 39.	STSW-STWBCGUI: Qi protocol window.	27
Figure 40.	STSW-STWBCGUI: monitor window	27
Figure 41.	STSW-STWBCGUI: parameter window	28
Figure 42.	STSW-STWBCGUI: parameter modification	29
Figure 43.	STSW-STWBCGUI: saving modified parameters (Dump to bin)	30
Figure 44.	STSW-STWBCGUI: bin file backup	30
Figure 45.	STSW-STWBCGUI: CAB file patch button	31
Figure 46.	STSW-STWBCGUI auto-calibration start	33
Figure 47.	STSW-STWBCGUI presence detection test	34
Figure 48.	STSW-STWBCGUI presence detection calibration check	35
Figure 49.	STEVAL-ISB045V1T test setup.	36
Figure 50.	Efficiency setup	36
Figure 51.	STEVAL-ISB045V1 evaluation board: efficiency vs output power.	37
Figure 52.	STEVAL-ISB045V1T circuit schematic (1 of 3)	38

Figure 53.	STEVAL-ISB045V1T circuit schematic (2 of 3)	39
Figure 54.	STEVAL-ISB045V1T circuit schematic (3 of 3)	40
Figure 55.	STEVAL-WBCDNGV1 circuit schematic	41
Figure 56.	STEVAL-ISB045V1T transmitter main blocks	45
Figure 57.	STEVAL-ISB045V1T transmitter: V_{IN} and 5 V power signal routing	46
Figure 58.	STEVAL-ISB045V1T transmitter: voltage supply for bridge MOSFETs (zoom).	47
Figure 59.	STEVAL-ISB045V1T transmitter: large tracks for wireless power coil connection.	48
Figure 60.	STEVAL-ISB045V1T transmitter: large tracks for wireless power coil connection (zoom)	49

IMPORTANT NOTICE – PLEASE READ CAREFULLY

STMicroelectronics NV and its subsidiaries (“ST”) reserve the right to make changes, corrections, enhancements, modifications, and improvements to ST products and/or to this document at any time without notice. Purchasers should obtain the latest relevant information on ST products before placing orders. ST products are sold pursuant to ST’s terms and conditions of sale in place at the time of order acknowledgement.

Purchasers are solely responsible for the choice, selection, and use of ST products and ST assumes no liability for application assistance or the design of Purchasers’ products.

No license, express or implied, to any intellectual property right is granted by ST herein.

Resale of ST products with provisions different from the information set forth herein shall void any warranty granted by ST for such product.

ST and the ST logo are trademarks of ST. For additional information about ST trademarks, please refer to www.st.com/trademarks. All other product or service names are the property of their respective owners.

Information in this document supersedes and replaces information previously supplied in any prior versions of this document.

© 2019 STMicroelectronics – All rights reserved