

## 70mA, 70V SMD Schottky Barrier Diode

### FEATURES

- Low turn-on voltage
- Fast switching
- Moisture sensitivity level: level 1, per J-STD-020
- RoHS Compliant
- Halogen-free according to IEC 61249-2-21

### APPLICATIONS

- Adapters
- For switching power supply
- Low stored charge
- Inverter

### MECHANICAL DATA

- Case: SOT-23
- Molding compound: UL flammability classification rating 94V-0
- Terminal: Matte tin plated leads, solderable per J-STD-002
- Meet JESD 201 class 1A whisker test
- Weight: 8 mg (approximately)

KEY PARAMETERS		
PARAMETER	VALUE	UNIT
$I_F$	70	mA
$V_{RRM}$	70	V
$I_{FSM}$	0.1	A
$V_F$ at $I_F=15mA$	1	V
$T_J$ Max.	125	°C
Package	SOT-23	



ABSOLUTE MAXIMUM RATINGS ( $T_A = 25^\circ\text{C}$ unless otherwise noted)				
PARAMETER		SYMBOL	VALUE	UNIT
Marking code on the device	BAS70		73	
	BAS70-04		74	
	BAS70-05		75	
	BAS70-06		76	
Repetitive peak reverse voltage		$V_{RRM}$	70	V
Working peak reverse voltage		$V_{RWM}$	70	V
DC blocking voltage		$V_R$	70	V
RMS reverse voltage		$V_{R(RMS)}$	49	V
Forward current		$I_F$	70	mA
Non-repetitive peak forward surge current @ $t = 1s$		$I_{FSM}$	100	mA
Power dissipation		$P_D$	200	mW
Junction temperature range		$T_J$	-55 to +125	°C
Storage temperature range		$T_{STG}$	-55 to +150	°C

<b>THERMAL PERFORMANCE</b>			
<b>PARAMETER</b>	<b>SYMBOL</b>	<b>TYP</b>	<b>UNIT</b>
Junction-to-ambient thermal resistance	$R_{\theta JA}$	625	°C/W

<b>ELECTRICAL SPECIFICATIONS</b> ( $T_A = 25^\circ\text{C}$ unless otherwise noted)					
<b>PARAMETER</b>	<b>CONDITIONS</b>	<b>SYMBOL</b>	<b>MIN</b>	<b>MAX</b>	<b>UNIT</b>
Forward voltage per diode <sup>(1)</sup>	$I_F = 1\text{mA}, T_J = 25^\circ\text{C}$	$V_F$	-	0.41	V
	$I_F = 15\text{mA}, T_J = 25^\circ\text{C}$			1.00	
Reverse current per diode <sup>(2)</sup>	$V_R = 50\text{V}, T_J = 25^\circ\text{C}$	$I_R$	-	100	nA
Reverse Breakdown Voltage	$I_R = 10\mu\text{A}$	$V_{(BR)}$	70	-	V
Junction capacitance	$f = 1\text{MHz}, V_R = 0\text{V}$	$C_J$	-	2	pF
Reverse Recovery Time	$I_F = I_R = 10\text{mA}, R_L = 100\Omega,$ $I_{RR} = 1\text{mA}$	$t_{rr}$	-	5	ns

**Notes:**

1. Pulse test with  $PW = 0.3\text{ms}$
2. Pulse test with  $PW = 30\text{ms}$

<b>ORDERING INFORMATION</b>		
<b>ORDERING CODE</b> (Note 1)	<b>PACKAGE</b>	<b>PACKING</b>
BAS7xxxx RF	SOT-23	3K / 7" Reel
BAS7xxxx RFG	SOT-23	3K / 7" Reel
BAS7xxxx-B0 RF	SOT-23	3K / 7" Reel
BAS7xxxx-B0 RFG	SOT-23	3K / 7" Reel
BAS7xxxx-D0 RF	SOT-23	3K / 7" Reel
BAS7xxxx-D0 RFG	SOT-23	3K / 7" Reel

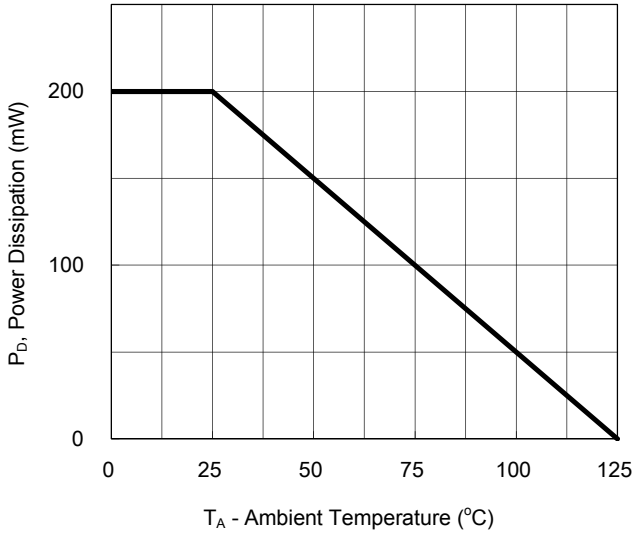
**Note:**

1. "xxxx" defines part no. from "0" to "0-06"

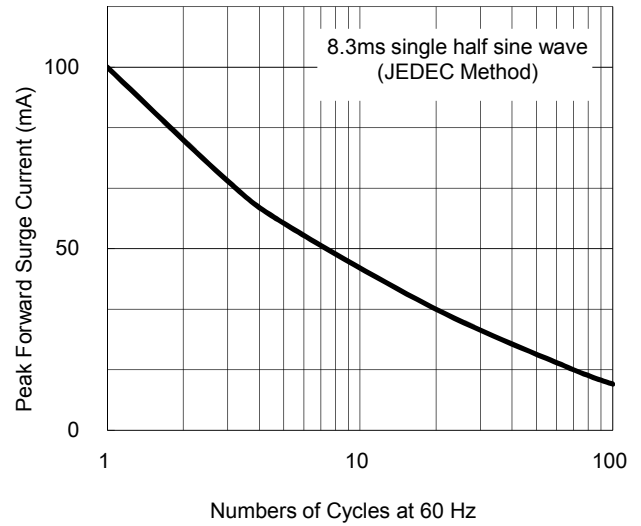
**CHARACTERISTICS CURVES**

( $T_A = 25^\circ\text{C}$  unless otherwise noted)

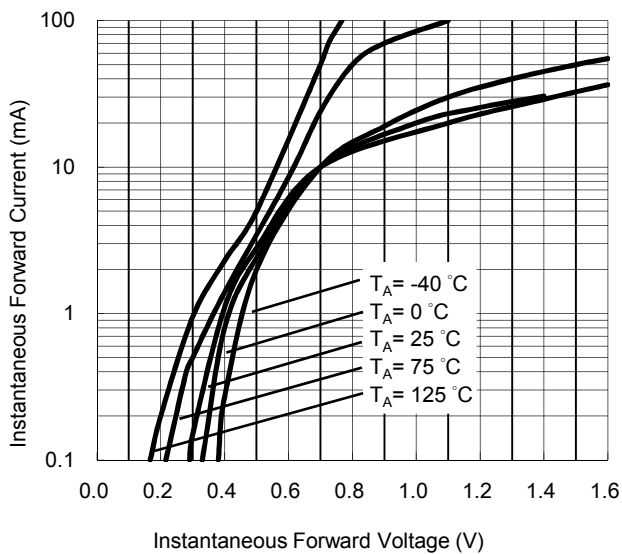
**Fig. 1 Power Derating Curve**



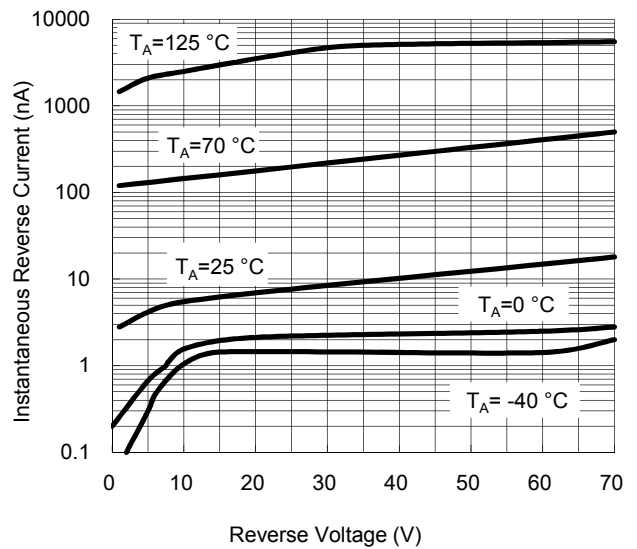
**Fig.2 Maximum Non-Repetitive Peak Forward Surge Current Per Leg**



**Fig.3 Typical Forward Characteristics**



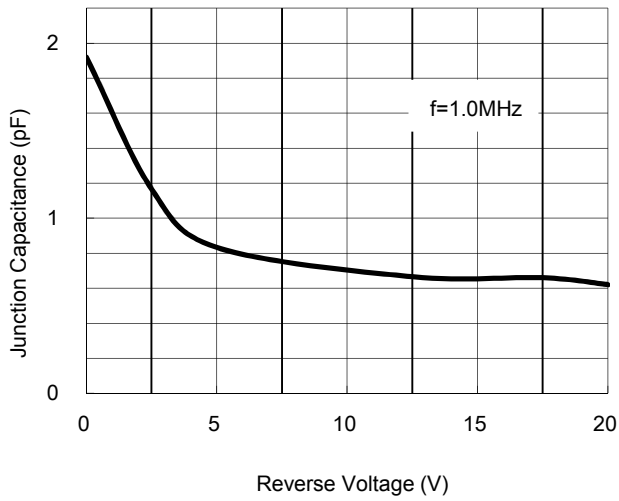
**Fig.4 Typical Reverse Characteristics**



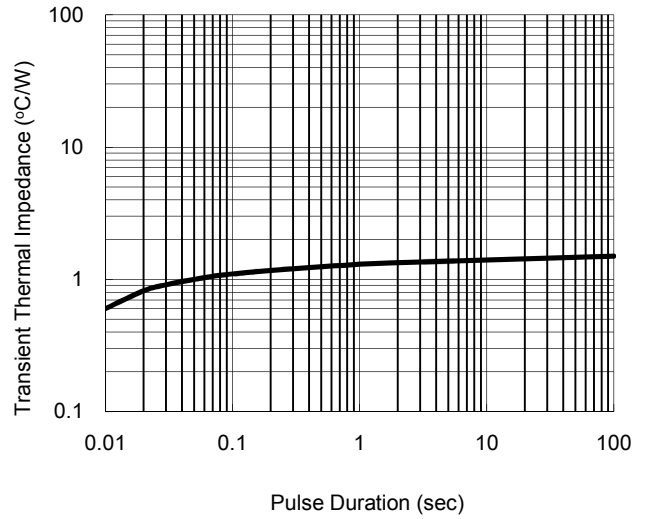
**CHARACTERISTICS CURVES**

(T<sub>A</sub> = 25°C unless otherwise noted)

**Fig. 5 Typical Total Capacitance VS. Reverse Voltage**

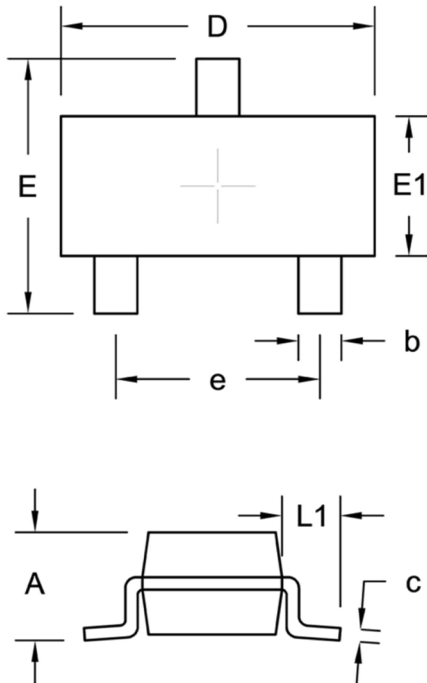


**Fig.6 Typical Transient Thermal Characteristics**



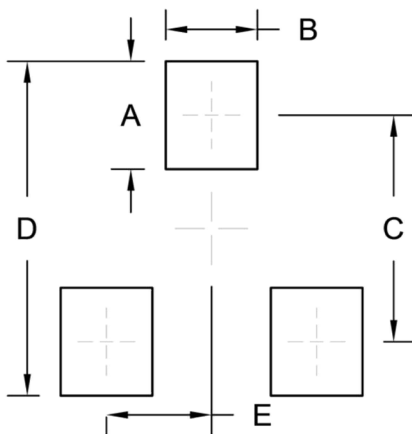
**PACKAGE OUTLINE DIMENSION**

SOT-23



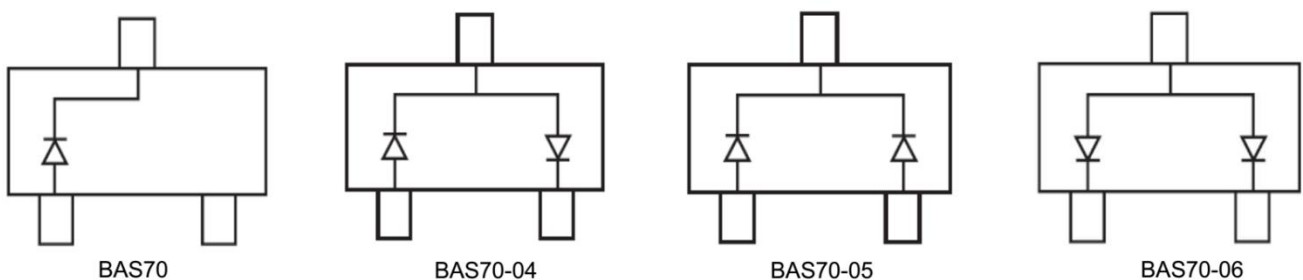
DIM.	Unit (mm)		Unit (inch)	
	Min.	Max.	Min.	Max.
A	0.89	1.12	0.035	0.044
b	0.30	0.50	0.012	0.020
c	0.08	0.20	0.003	0.008
D	2.80	3.04	0.110	0.120
E	2.10	2.64	0.083	0.104
E1	1.20	1.40	0.047	0.055
e	1.90 BSC		0.075 BSC	
L1	0.54 REF.		0.021 REF.	

**SUGGEST PAD LAYOUT**



Symbol	Unit (mm)	Unit (inch)
A	1.00	0.039
B	0.85	0.033
C	2.10	0.083
D	3.10	0.122
E	0.98	0.039

**PIN CONFIGURATION**



## Notice

Specifications of the products displayed herein are subject to change without notice. TSC or anyone on its behalf, assumes no responsibility or liability for any errors or inaccuracies.

Purchasers are solely responsible for the choice, selection, and use of TSC products and TSC assumes no liability for application assistance or the design of Purchasers' products.

Information contained herein is intended to provide a product description only. No license, express or implied, to any intellectual property rights is granted by this document. Except as provided in TSC's terms and conditions of sale for such products, TSC assumes no liability whatsoever, and disclaims any express or implied warranty, relating to sale and/or use of TSC products including liability or warranties relating to fitness for a particular purpose, merchantability, or infringement of any patent, copyright, or other intellectual property right.

The products shown herein are not designed for use in medical, life-saving, or life-sustaining applications. Customers using or selling these products for use in such applications do so at their own risk and agree to fully indemnify TSC for any damages resulting from such improper use or sale.