

样品说明(SAMPLE DESCRIPTION)

样品用途 THE PURPOSE OF THE SAMPLE	无样板 (NO-SAMPLE)	工作样板 (WORK-SAMPLE)	功能样板 (FUNCTION-SAMPLE)	最终样板 (FINALLY-SAMPLE)
	<input type="checkbox"/>	<input type="checkbox"/>	<input checked="" type="checkbox"/>	<input type="checkbox"/>

此次送样后如客人测试 OK, 还需继续的事项/

THE ITEMS NEED BE CONTINUED OF THESE SAMPLES CONFIRMED BY CLIENT

EMI 整改/EMI MODIFICATION	安规申请 /SAFETY APPLY	修改 PCB 设计/ PCB MODIFICATION	开模/MOULD			试产 /TRIAL-PRODUCE
			PCB	DC CORD	CASE	
<input type="checkbox"/>	<input type="checkbox"/>	<input type="checkbox"/>	<input type="checkbox"/>	<input type="checkbox"/>	<input type="checkbox"/>	<input checked="" type="checkbox"/>

送样材料偏差清单/

DIFFERENCE OF THE SAMPLE WITH BOM:

位置编号 POSITION NO.	元件类型 PART TYPE	本次送样实际使用 MATERIAL OF THIS SAMPLE	未来量产应用 MASS-PRODUCTION MATERIAL	备注 REMARK

与上次送样差异描述/



DIFFERENCE OF THE SAMPLE WITH BOM:

编号 NO.	上次样品内容 ITEM OF LAST TIME	本次样品改变内容 CHANGED ITEM OF THIS TIME	改变原因 CHANGE REASON
1			
2			
3			
4			
5			

--	--	--	--	--	--

P/N	REV.	DATE	ISSUED BY	CHECKED BY	APPROVED BY
S-1900186	4	2020/6/23	钟小青	Alan	Eric

Design Revision History

REV.	Description of Change		Reason of Change	Changed Date	Revised By	Approved By
	Before	After				
0			Initial Issue	2019.07.10	Sky	Eric
1		Add UL mark	Engineer Change	2019.07.16	Sky	Eric
2		Add mark on carton and white box	Customer need	2019.10.7	Sky	Eric
3	CUSTOMER P/N: 40XA065BC141200500-2.5	CUSTOMER P/N: 40XA065BQ1200500-2.5	Customer change	2019-10-16	SKY	Eric
	Carten to show part number:40XA065BC141200500-2.5&RoHS	Carten to show part number:40XA065BQ1200500-2.5&RoHS				
4	UL file number: E342355 +/- marking:  No output power:	UL file number: E501552 +/- marking:  output power: 60.0W	Update nameplate	2020/6/23	钟小青	刘诗鑫

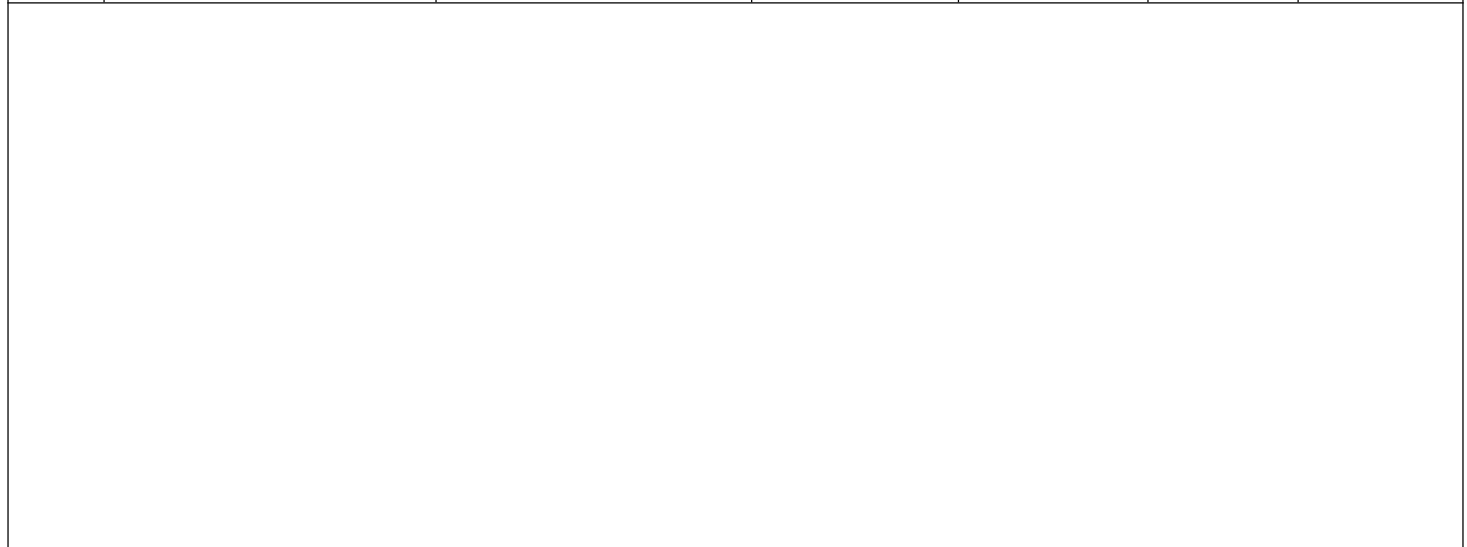

P/N	REV.	DATE	ISSUED BY	CHECKED BY	APPROVED BY
S-1900186	4	2020/6/23	钟小青	Alan	Eric

Table of Contents

NO.	Content	Page
1	SPECIFICATION FOR APPROVAL	1
2	SAMPLE DESCRIPTION	2
3	DESIGN REVISION HISTORY	3
4	TABLE OF CONTENTS	4
5	SCOPE	5
6	INPUT REQUIREMENTS	5
7	OUTPUT FEATURES	5
8	PROTECTION REQUIREMENT	6
9	ENVIRONMENTAL CONDITIONS	6
10	RELIABILITY AND QUALITY CONTROL	6
11	MECHANICAL CHARACTERISTICS	7
12	SAFETY	7
13	EMC STANDARDS	7
14	OTHER REQUIREMENTS	8
	APPENDIX	
	APPENDIX A External View	9
	APPENDIX B Name Plate Drawing	10
	APPENDIX C DC CORD Drawing	11
	APPENDIX D Packing Drawing	12
	APPENDIX E Description for marking on carton and white box	13
	APPENDIX F Test Report	14-17

P/N	REV.	DATE	ISSUED BY	CHECKED BY	APPROVED BY
S-1900186	4	2020/6/23	钟小青	Alan	Eric

1. SCOPE

This document details the electrical, mechanical and environmental specifications of a switching power supply.

1.1 Description

- Wall Mount
 Desk-Top
 Open Frame
 Others

2. INPUT REQUIREMENTS

2.1 Input Voltage & Frequency

The range of input voltage is from 90Vac to 264Vac

	Min	Normal	Max.
Input Voltage	90Vac	100-240Vac	264Vac
Input Frequency	47Hz	50/60Hz	63Hz

2.2 Input current

The maximum input current is 1.5A Max. at 100-240Vac .

2.3 Inrush Current

The inrush current will not exceed 50A at 100-240Vac input and Max load for a cold start at 25°C.

3. OUTPUT FEATURES

3.1 Output Parameters

	Output Data	Spec. Limit			Test Condition
		Min. Value	Typical	Max. Value	
3.1.1	12.0Vdc				
3.1.2	Output Voltage	11.4Vdc	12.0Vdc	12.6Vdc	0-5.0A Loading
3.1.3	Output Load	0A	—	5.0A	
3.1.4	Ripple and Noise	—	—	200mVp-p	20MHz Bandwidth 10uF Elec. Cap.0.1uF Cer. Cap.
3.1.5	Output Overshoot	—	—	10%	MAX. load & 100-240Vac

3.2 Turn On Delay

During turn on and turn off, no output voltage shall exceed its nominal voltage by more than 10% and no output shall change its polarity with respect to its return line. All outputs shall reach their steady state values within 3 seconds of turn on.

3.3 Hold Up Time

10 ms minimum at 115Vac/60Hz input at maximum load, and 20 ms minimum at 230Vac/50Hz input at maximum load.

P/N	REV.	DATE	ISSUED BY	CHECKED BY	APPROVED BY
S-1900186	4	2020/6/23	钟小青	Alan	Eric

3.4 Output Transient Response

The power supply shall maintain output transient response time within 1500mV with a loading current change from 20% to 80% of maximum current and 0.5A/ μ s rise up /drop down test at end of output terminal.

4. PROTECTION REQUIREMENT

4.1 Over Voltage Protection

Over voltage protection shall be included in the adaptor circuit. A single component failure must not cause an over voltage.

4.2 Over Current Protection

The adaptor must have a current limiting function on the output voltage. in overload mode, the output must drop to a low voltage. The OCP 6.5A max

4.3 Short Circuit Protection

The adaptor must withstand a continuous short circuit on the output without damage.

5. ENVIRONMENTAL CONDITIONS

5.1 Operating

The power supply shall be capable of operating normally in any mode without malfunction happens in the following environmental conditions.

5.1.1 Operating Temperature: 0°C ~40°C

Relative Humidity: 10% ~ 90%

Altitude: Sea level to 2,000 m.

5.1.2 Vibration: 1.0mm, 10 -55Hz, 15 minutes per cycle for each axis (X, Y, Z).

5.1.3 Cooling: Natural convection cooling.

5.2 Non - Operating

The power supply shall be capable of withstanding the following environmental conditions extended periods of time, without sustaining electrical or mechanical damage and subsequent operational deficiencies.

5.2.1 Storage Temperature: -10°C ~ 70°C

5.2.2 Relative Humidity: 5% ~ 95%

5.2.3 Altitude: Sea level to 2,000 m.

5.2.4 Vibration and Shock:

The power supply shall be designed to withstand normal transportation vibration per MIL-STD-810D, method 514 and procedures X, as it is mounted in the chassis assembly and packed for shipping.

6. RELIABILITY AND QUALITY CONTROL

6.1 MTBF

When the power supply is operating within the limits of this specification the MTBF shall be at least 50000 hours at 25°C (MIL-HDBK-217F).

6.2 Burn-In

The power supply shall withstand a minimum of 4 hours Burn-In test under full load at 35°C ~40°C room temperature, after test, product shall operate normally.

P/N	REV.	DATE	ISSUED BY	CHECKED BY	APPROVED BY
S-1900186	4	2020/6/23	钟小青	Alan	Eric

6.3 Component De-rating

Semiconductor junction temperatures shall not exceed the manufacturer's maximum thermal rating.

7. MECHANICAL CHARACTERISTICS

7.1 Physical Dimensions

The detail dimension of the power supply is drawing on APPENDIX A.

7.2 Nameplate

The label of the power supply, please see APPENDIX B.

7.3 Drop test

Dropped freely from 1 m (for wall mount product) height onto the surface is consisted of hardwood 13 mm thick, mounted on two layers of plywood each 19-20 mm thick, all supported on concrete floor 1 time from 3 different surface, after test, it's no safety damage for product.

8. SAFETY

8.1 Safety Standard

The power supply shall be certified under the following international regulatory standards.

Item	Country	Certified	Standard	Present
UL	USA	APPROVED	UL60950-1 2 nd /UL62368-1	✓
CUL	Canada	APPROVED	CSA C22.2 NO.60950-1/62368-1	✓
FCC	USA	APPROVED	PART 15 CLASS B	✓
TUV/GS	Europe		EN 60950-1 2 nd /EN60065/EN62368-1	□
CE	Europe	APPROVED	EN 55032 EN55024	✓
BS/UK	Britain		BS EN 60950-1 2 nd /EN60065	□
SAA	Australia		AS/NZS 60950-1/NZS60065	□
CCC	China		GB9254/GB8898/GB4943	□
KC	Korea		K60950	□
PSE	Japan		J60950 (H27)/J60065(H26)	□
Others				□

8.2 Insulation Resistance

Input to output: 10 MΩ min. at 500 VDC.

8.3 Dielectric Strength (Hi-Pot)

Primary to Secondary DC2121V or AC1500V 10mA 1 minute for type test, 3 seconds for product.

8.4 Leakage Current

The leakage current shall be less than 5mA when the power supply is operated maximum input voltage and maximum frequency.

9. EMC STANDARDS

9.1 EMI Standards

The power supply shall meet the radiated and conducted emission requirements for EN55032 CLASS B,FCC PART 15 CLASS B.

9.2 EMS Standards(EN55035)

The power supply shall meet the following EMS standards.

P/N	REV.	DATE	ISSUED BY	CHECKED BY	APPROVED BY
S-1900186	4	2020/6/23	钟小青	Alan	Eric

- 9.2.1 IEC61000-4-2 Electrostatic Discharge (ESD)
 Static – discharge test by contact or air should be conducted with Static – discharge teeter, energy storage capacitance of 150pF, and discharge resistance of 330Ω.
8KV air discharge, 4KV contact discharge, Performance Criterion B.
- 9.2.2 IEC61000-4-3 Radiated Electromagnetic Fields(RS)
 Radio- frequency Electromagnetic Field Susceptibility Test, RS, 80-1000MHz,3V/m, 80%AM(1KHz), Performance Criterion A.
- 9.2.3 IEC61000-4-4 Electrical Fast Transient / Burst (EFT)
 Power Line to Line: 1KV
 Performance Criterion B.
- 9.2.4 IEC61000-4-5 Lightning Surge Attachment
 Lightning Surge voltage of differential and common modes shall be applied across AC input lines and across input and frame ground.
 Power Line to Line (Common Mode): 1KV
 Power Line & Neutral to Earth (Different Mode): 2KV
- 9.2.5 IEC61000-4-6 Conducted Radio Frequency Disturbances (CS)
 Conducted Radio Frequency Disturbances Test, CS, 0.15-80 MHz, 3V/m, 80%AM, 1KHz, Performance Criterion A.
- 9.2.6 IEC61000-4-11 Voltage Dips/Short Interruption/Variations
 Voltage dips >95%,0.5 preiods, Performance criterion B,
 Voltage dips 30%,25 preiods, Performance criterion C,
 Voltage interruptions >95%,250 preiods, Performance criterion C.

10. OTHER REQUIREMENTS

10.1 Hazardous Substances

The components and used materials shall be in compliance with

EU Directive 2015/863/EU "RoHS 3"

10.2 Energy Efficiency

The power supply shall meet the following EMS standards.

10.2.1 The No-Load power consumption shall be less than 0.21W at input 115/230 Vac.

10.2.2 The average active mode efficiency shall be higher than 88.0% at input 115/230 Vac.

10.2.3 International Efficiency Level VI

10.2.4 This power supply is therefore in compliance with the requirements of

California Energy Commission for external power supplies (CEC)

Energy Star requirements for external power supplies(EPS Version 2.0)

EU Code of Conduct Energy requirements of external power supplies

Australian and New Zed Energy Performance Requirements for external power supplies (MEPS)

China Energy Efficiency requirements for external power supplies (GB20943)

P/N	REV.	DATE	ISSUED BY	CHECKED BY	APPROVED BY
S-1900186	4	2020/6/23	钟小青	Alan	Eric

APPENDIX A

External View

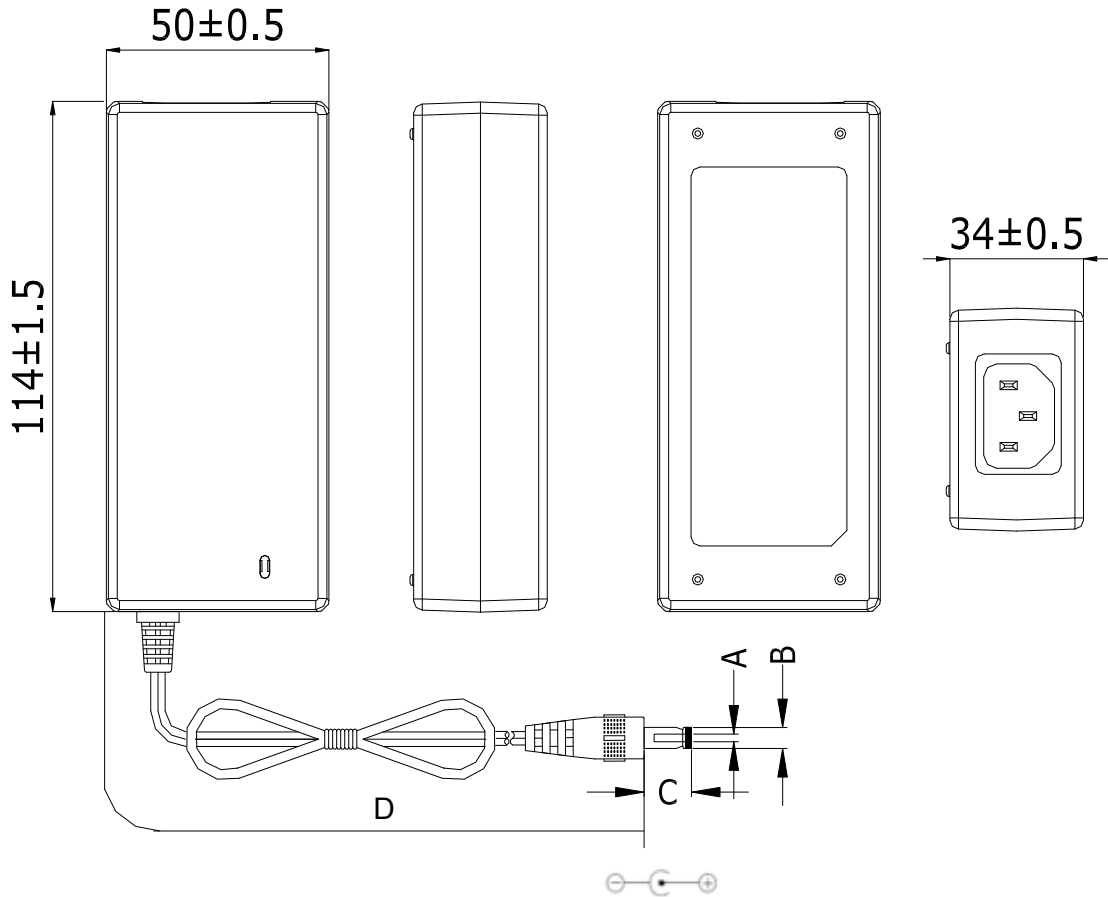

Unit : mm

	ΦA	ΦB	C	D
DIMENSION	2.5	5.5	12	1500
TOLERANCE	+0.1/-0	±0.1	±0.5	±50
REMARK	AWG18#/2C UL2468 BLACK "Tunning fork with groove"			

P/N	REV.	DATE	ISSUED BY	CHECKED BY	APPROVED BY
S-1900186	4	2020/6/23	钟小青	Alan	Eric

APPENDIX B

Nameplate

84.49 mm



Unit: mm
Tolerance: +0/-0.2
Printed by Laser Printer

* Please Advise If Any Comments About The Name Plate Information
Otherwise, This Information Is Defaulted As Customer Approval,
And Will Be Applied To Production.

P/N	REV.	DATE	ISSUED BY	CHECKED BY	APPROVED BY
S-1900186	4	2020/6/23	钟小青	Alan	Eric

APPENDIX C

DC CORD

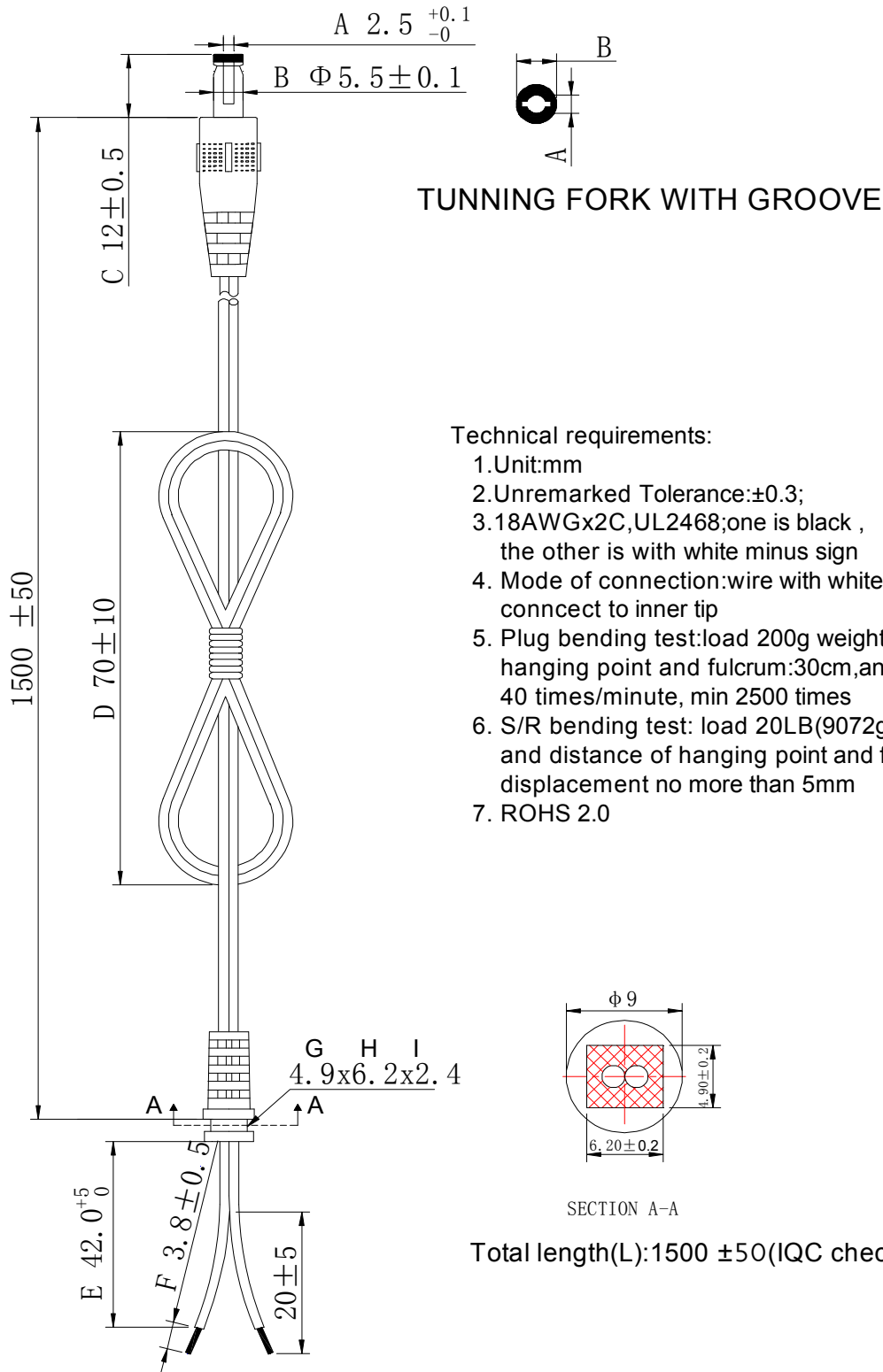

Technical requirements:

1. Unit: mm
2. Unremarked Tolerance: ± 0.3 ;
3. 18AWGx2C, UL2468; one is black, the other is with white minus sign
4. Mode of connection: wire with white minus sign connect to inner tip
5. Plug bending test: load 200g weight, distance of hanging point and fulcrum: 30cm, angle: 60° 40 times/minute, min 2500 times
6. S/R bending test: load 20LB(9072g), continuous 1minute and distance of hanging point and fulcrum is 30cm, displacement no more than 5mm
7. ROHS 2.0

P/N	REV.	DATE	ISSUED BY	CHECKED BY	APPROVED BY
S-1900186	4	2020/6/23	钟小青	Alan	Eric

APPENDIX D

Packing Drawing

PRUDUCT/产品:



DIMENSION(UNIT IN cm):

	L	W	H
WHITE BOX	9.0	4.0	14.0
PAPERBOARD	37.0	37.0	0.5
CARTON	38.5	38.5	30.8

PRIMARY BOX/小白盒:

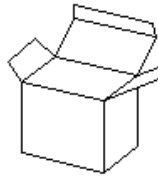

PACKING METHOD:

PAPERBOARD PLACEMENT METHOD	PUT A PAPERBOARD BETWEEN THE TOP AND BOTTOM, TOTAL 2PCS
PACKING METHOD	36PCS/LAYER X 2 LAYERS
QTY	72PCS
N.W.	14.50KG
G.W.	15.65KG

PAPERBOARD/平卡:

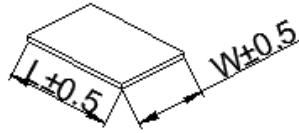

CARTON/纸箱:

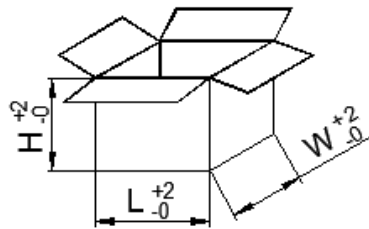

备注：以上 N.W/G.W 供参考，实际以大货生产为准。

REMARK:

- STORAGE CONDITION
 TEMPERATURE: -10°C~+60°C
 RELATIVE HUMIDITY: 30%~80%
- STORAGE PERIOD: 6 MONTHES
- ANLISTATIG: NO REQUIREMENT
- PLEASE ADVISE IF ANY COMMENTS ABOUT THE PACKING INFORMATION.
 OTHERWISE, THIS INFORMATION IS DEFAULTED AS CUSTOMER APPROVAL,
 AND WILL BE APPLIED TO PRODUCTION.

P/N	REV.	DATE	ISSUED BY	CHECKED BY	APPROVED BY
S-1900186	4	2020/6/23	钟小青	Alan	Eric

APPENDIX E

Description for marking on carton and white box

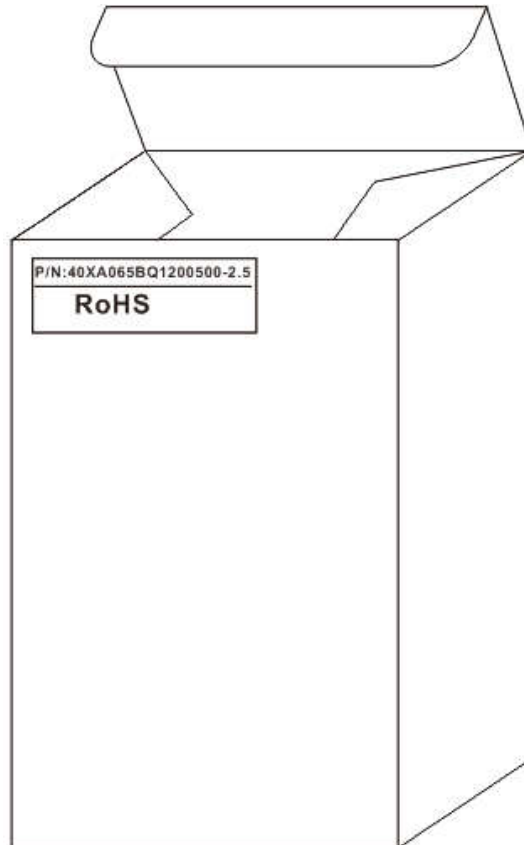
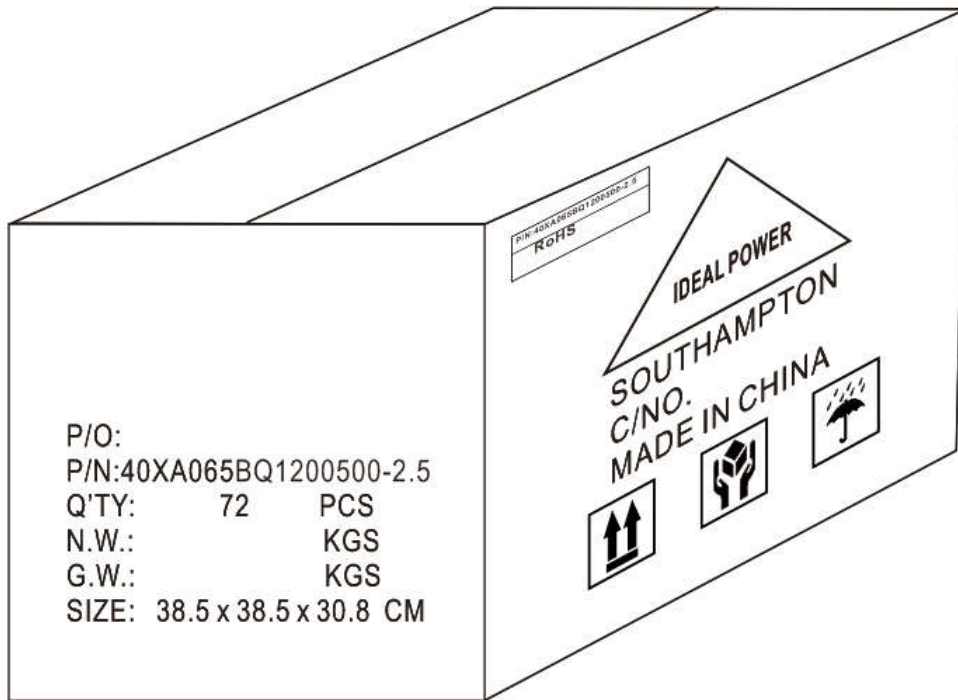

P/N	REV.	DATE	ISSUED BY	CHECKED BY	APPROVED BY
S-1900186	4	2020/6/23	钟小青	Alan	Eric

APPENDIX E

SAMPLE TEST REPORT

CUSTOMER		Ideal Power			P/N		S-1900186		
MODEL NO.		XA065BQ1200500 1#			CUSTOMER P/N		40XA065BQ1200500-2.5		
Items No.	Test Items	Unit	Test condition & result				Spec. Limit	Pass/Fail	
			90Vac 60Hz	115Vac 60Hz	230Vac 50Hz	264Vac 50Hz			
1	Unload input current	mA	15.27	19.76	33.99	38.21	—	-	
2	Unload input power	W	0.05	0.05	0.05	0.13	<0.21W	Pass	
3	Rated load input current	mA	1225.0	970.1	497.2	448.2	≤1500mA	Pass	
4	Rated load input power	W	68.95	67.53	67.29	67.36	—	-	
5	Unload output voltage (0.0A)	V	12.28	12.28	12.28	12.28	11.4-12.6Vdc	Pass	
6	Rated load output voltage (5.0A)	V	11.57	11.66	11.69	11.69	11.4-12.6Vdc	Pass	
7	Rated load Output ripple&noise voltage (5.0A)	mV	177	177	141	141	≤200mVp-p	Pass	
8	Short-circuit test (Pin&lout)	W	3.69	3.96	4.36	4.31	≤6W	Pass	
9	Over current protection	A	5.99	6.29	6.23	6.05	OCP≤6.5A	Pass	
10	Output overshoot	%	-	-	-	-	≤10%	-	
11	Turn on delay time	mS	-	-	-	-	≤3000mS	-	
12	Hold up time	mS	-	-	-	-	≥10mS / (115Vac) ≥20mS / (230Vac)	-	
13	Efficiency	%	-	-	-	-	≥88.0%	-	
14	Hi-pot test	Pri. to Sec. : 2121Vdc, 1Minute, Cut off current≤10mA (Test result: 0.0002mA)						Pass	
15	Max. and Light load change test	Max. load to Light load: OK Light load to max. load: OK (90-264Vac)							
16	Burn-in	Burn-in 4 Hrs, The sample OK							
17	Appe. label and fusion	Appearance: OK, Label: OK, Fusion: OK							
P/N		REV.	DATE	ISSUED BY	CHECKED BY	APPROVED BY			
S-1900186		4	2020/6/23	钟小青	Alan	Eric			

APPENDIX E

Energy Star TEST REPORT

CUSTOMER	Ideal Power			P/N				S-1900186		
MODEL NO.	XA065BQ1200500	1#	CUSTOMER P/N				40XA065BQ1200500-2.5			
Items No.	Test parameter	Unit	Input voltage 115Vac/60Hz						Spec. Limit	Pass/Fail
			100%	75%	50%	25%	0%	Aver.Eff.		
1	Input current	mA	973.2	724.1	475.9	275.1	19.76		≤ 1500mA	Pass
2	Input power	W	67.79	50.59	33.53	16.79	0.05		-	-
3	Output current	A	5	3.75	2.5	1.25			-	-
4	Output voltage	V	11.67	11.84	11.99	12.13			-	-
5	Power factor	-	-	-	-	-			-	-
6	Efficiency	%	86.07	87.76	89.40	90.30		88.38	≥88.0%	Pass

Items No.	Test parameter	Unit	Input voltage 230Vac/50Hz						Spec. Limit	Pass/Fail
			100%	75%	50%	25%	0%	Aver.Eff.		
1	Input current	mA	500.2	374.9	248.2	144.0	35.51		≤1500mA	Pass
2	Input power	W	67.15	50.23	33.48	16.90	0.13		-	-
3	Output current	A	5	3.75	2.5	1.25			-	-
4	Output voltage	V	11.70	11.84	11.99	12.13			-	-
5	Power factor	-	-	-	-	-			-	-
6	Efficiency	%	87.11	88.39	89.53	89.71		88.68	≥88.0%	Pass

Note: 1. Aver.Eff.Spec.(≥88.0 %) & Unload input power Spec.(≤0.21W)for EPS Version 2.0)

P/N	REV.	DATE	ISSUED BY	CHECKED BY	APPROVED BY
S-1900186	4	2020/6/23	钟小青	Alan	Eric

APPENDIX E

SAMPLE TEST REPORT

CUSTOMER		Ideal Power		P/N		S-1900186		
MODEL NO.		XA065BQ1200500 2#		CUSTOMER P/N		40XA065BQ1200500-2.5		
Items No.	Test Items	Unit	Test condition & result				Spec. Limit	Pass/Fail
			90Vac 60Hz	115Vac 60Hz	230Vac 50Hz	264Vac 50Hz		
1	Unload input current	mA	17.56	20.08	34.91	38.99	—	-
2	Unload input power	W	0.05	0.08	0.13	0.15	<0.21W	Pass
3	Rated load input current	mA	1229.1	985.4	504.2	450.2	≤1500mA	Pass
4	Rated load input power	W	68.80	67.85	67.13	67.25	—	-
5	Unload output voltage (0.0A)	V	12.27	12.27	12.26	12.25	11.4-12.6Vdc	Pass
6	Rated load output voltage (5.0A)	V	11.65	11.69	11.72	11.71	11.4-12.6Vdc	Pass
7	Rated load Output ripple&noise voltage (5.0A)	mV	185	173	129	129	≤200mVp-p	Pass
8	Short-circuit test (Pin&lout)	W	3.55	3.76	4.32	4.63	≤6W	Pass
9	Over current protection	A	6.00	6.26	6.28	6.06	OCP≤6.5A	Pass
10	Output overshoot	%	-	-	-	-	≤10%	-
11	Turn on delay time	mS	-	-	-	-	≤3000mS	-
12	Hold up time	mS	-	-	-	-	≥10mS / (115Vac) ≥20mS / (230Vac)	-
13	Efficiency	%	-	-	-	-	≥88.0%	-
14	Hi-pot test	Pri. to Sec. : 2121Vdc, 1Minute, Cut off current≤10mA (Test result: 0.0002mA)						Pass
15	Max. and Light load change test	Max. load to Light load: OK Light load to max. load: OK (90-264Vac)						
16	Burn-in	Burn-in 4 Hrs, The sample OK						
17	Appe. label and fusion	Appearance: OK, Label: OK, Fusion: OK						
P/N		REV.	DATE	ISSUED BY	CHECKED BY	APPROVED BY		
S-1900186		4	2020/6/23	钟小青	Alan	Eric		

APPENDIX E

Energy Star TEST REPORT

CUSTOMER	Ideal Power	P/N	S-1900186							
MODEL NO.	XA065BQ1200500 2#	CUSTOMER P/N	40XA065BQ1200500-2.5							
Items No.	Test parameter	Unit	Input voltage 115Vac/60Hz						Spec. Limit	Pass/Fail
			100%	75%	50%	25%	0%	Aver.Eff.		
1	Input current	mA	972.5	722.4	477.6	274.2	33.99		≤ 1500mA	Pass
2	Input power	W	67.89	50.66	33.56	16.80	0.05		-	-
3	Output current	A	5	3.75	2.5	1.25			-	-
4	Output voltage	V	11.68	11.85	11.98	12.12			-	-
5	Power factor	-	-	-	-	-			-	-
6	Efficiency	%	86.02	87.71	89.24	90.17		88.30	≥ 88.0%	Pass

Items No.	Test parameter	Unit	Input voltage 230Vac/50Hz						Spec. Limit	Pass/Fail
			100%	75%	50%	25%	0%	Aver.Eff.		
1	Input current	mA	499.5	375.6	249.6	143.6	34.91		≤ 1500mA	Pass
2	Input power	W	67.14	50.24	33.48	16.93	0.13		-	-
3	Output current	A	5	3.75	2.5	1.25			-	-
4	Output voltage	V	11.70	11.82	12.01	12.13			-	-
5	Power factor	-	-	-	-	-			-	-
6	Efficiency	%	87.13	88.22	89.68	89.60		88.66	≥88.0%	Pass

Note: 1. Aver.Eff.Spec.(≥88.0 %) & Unload input power Spec.(≤0.21W)for EPS Version 2.0)

P/N	REV.	DATE	ISSUED BY	CHECKED BY	APPROVED BY
S-1900186	4	2020/6/23	钟小青	Alan	Eric