

7 6 5 4 3 2 1

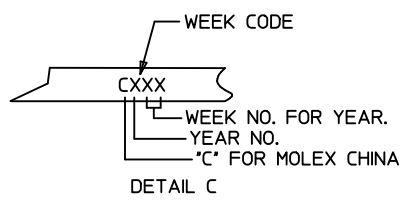
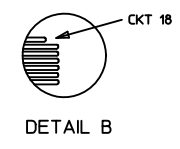
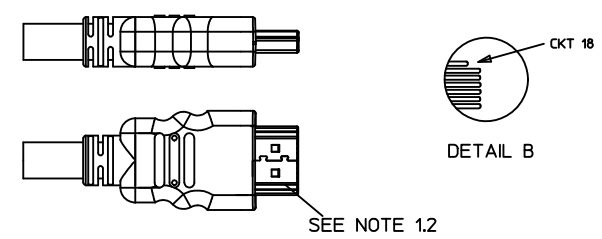
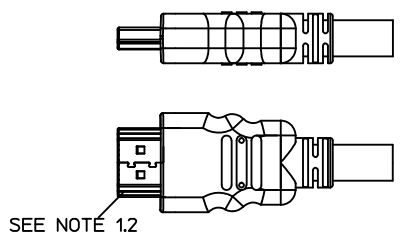
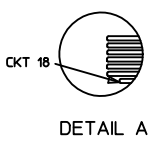
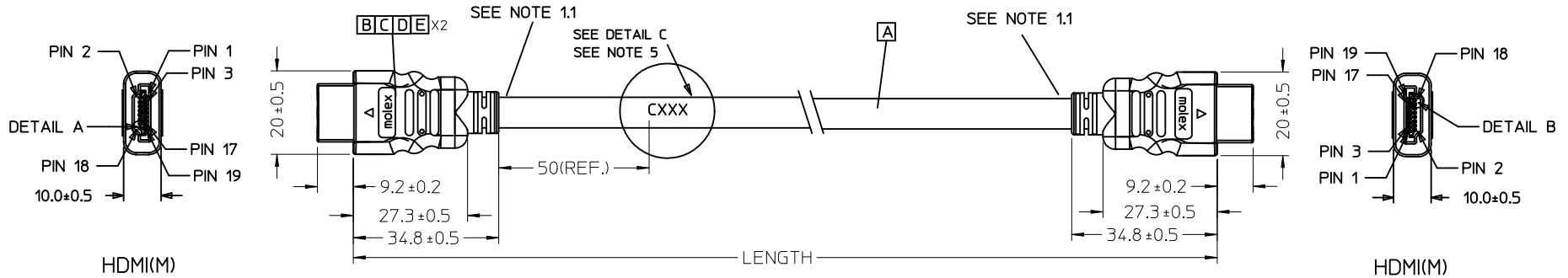

MX P/N	DESCRIPTION	LENGTH	CABLE COLOR	CABLE OD	CABLE P/N
887689830	HDMI TO HDMI CABLE ASS'Y,5M	5000 ± 100	BLACK	7.3MM(TMDS - AWG#28)	172005984
887689820	HDMI TO HDMI CABLE ASS'Y,3M	3000 ± 80	BLACK	7.3MM(TMDS - AWG#28)	172005984
887689810	HDMI TO HDMI CABLE ASS'Y,2M	2000 ± 60	BLACK	7.3MM(TMDS - AWG#28)	172005984
887689800	HDMI TO HDMI CABLE ASS'Y,1M	1000 ± 30	BLACK	7.3MM(TMDS - AWG#28)	172005984

ENTER DESCRIPTION EC NO: DG2011-0439 DRWN: FZHANG01 CHKD: JLU13 APPR: ZXDENG	2011/05/04 2011/05/04 2011/05/11	DESCRIPTION REV	QUALITY SYMBOLS ▽=0 ▽=0	GENERAL TOLERANCES (UNLESS SPECIFIED) mm INCH 4 PLACES ± --- ± --- 3 PLACES ± --- ± --- 2 PLACES ± --- ± --- 1 PLACE ± --- ± --- ANGULAR ± ---°	DIMENSION STYLE MM ONLY DRAWN BY DATE FZHANG01 2011/05/04 CHECKED BY DATE LPNING 2011/05/04 APPROVED BY DATE ZXDENG 2011/05/11	SCALE ---	DESIGN UNITS METRIC	THIRD ANGLE PROJECTION		
			DRAFT WHERE APPLICABLE MUST REMAIN WITHIN DIMENSIONS				MATERIAL NO. SEE TABLE	TITLE HDMI(M) TO HDMI(M) CABLE ASS'Y		
			MOLEX INCORPORATED				DOCUMENT NO. SD-88768-9800	SHEET NO. 1 OF 2		
			THIS DRAWING CONTAINS INFORMATION THAT IS PROPRIETARY TO MOLEX INCORPORATED AND SHOULD NOT BE USED WITHOUT WRITTEN PERMISSION							

6 5 4 3 2 1

NOTE:

1. OVERMOLD SPECIFICATION:
 - 1.1 HDMI OUTER MOLDED WITH PVC RESIN
HDMI INNER MOLDED WITH PVC RESIN
 - 1.2 DUST COVER MOLDED WITH PE
2. PRODUCT ELECTRICAL SPECIFICATION REFER TO HDMI SPEC.
3. THE CODE PLEASE BE PRINTED ON THE SPACE
4. THIS PRODUCT MUST MEET EU CHEMICAL SUBSTANCE SPECIFICATION FOR PRODUCTS. (EU 2002/95/EC)

WIRE DIAGRAM:

SHIELD	SHIELD	OVERALL SHIELD	GROUND
PIN 19	PIN 19	PINK	HOT PLUG DETECT
PIN 18	PIN 18	ORANGE	+5V POWER
PIN 17	PIN 17	YELLOW	DDC/CEC GROUND
PIN 16	PIN 16	WHITE	SDA
PIN 15	PIN 15	RED	SCL
PIN 14	PIN 14	VIOLET	RESERVED
PIN 13	PIN 13	GRAY	CEC
PIN 12	PIN 12	WHITE	TMDS CLOCK-
PIN 11	PIN 11	BRAID	TMDS CLOCK SHIELD
PIN 10	PIN 10	BLACK	TMDS CLOCK+
PIN 9	PIN 9	WHITE	TMDS DATA 0-
PIN 8	PIN 8	BRAID	TMDS DATA 0 SHIELD
PIN 7	PIN 7	BLUE	TMDS DATA 0+
PIN 6	PIN 6	WHITE	TMDS DATA 1-
PIN 5	PIN 5	BRAID	TMDS DATA 1 SHIELD
PIN 4	PIN 4	GREEN	TMDS DATA 1+
PIN 3	PIN 3	WHITE	TMDS DATA 2-
PIN 2	PIN 2	BRAID	TMDS DATA 2 SHIELD
PIN 1	PIN 1	RED	TMDS DATA 2+
HDMI	HDMI	COLOR	CABLE FUNCTION

E	PRE-CUT C.Foil 47X23mm T=25U	2	
D	COPPER FOIL	2	
C	HDMI 19P MALE,30U"Au Solder Type	2	
B	Metal Shell For HDMI 19P Male	2	
A	(4P+1P)X28+5CX28,ALSH,PVC,BK,7.3,UL20276 (SEE TABLE)	1	
ITEM	DESCRIPTION	L	QTY.

ENTER DESCRIPTION EC NO: DG2011-0439 DRWN:FZHANG01 CHKD:JLU13 APPR:ZXDENG	DESCRIPTION REV	QUALITY SYMBOLS	GENERAL TOLERANCES (UNLESS SPECIFIED)	DIMENSION STYLE	SCALE	DESIGN UNITS	THIRD ANGLE PROJECTION	
		▼=0 ▽=0	mm INCH	MM ONLY	---	METRIC		
		4 PLACES ± --- ± --- 3 PLACES ± --- ± --- 2 PLACES ± --- ± --- 1 PLACE ± --- ± ---	DRAWN BY DATE FZHANG01 2011/05/04 CHECKED BY DATE LPNING 2011/05/04 APPROVED BY DATE ZXDENG 2011/05/11	TITLE		HDMI(M) TO HDMI(M) CABLE ASS'Y		
		ANGULAR ± ---°	MATERIAL NO.	MOLEX INCORPORATED		SHEET NO.		
		DRAFT WHERE APPLICABLE MUST REMAIN WITHIN DIMENSIONS	SEE TABLE	SD-88768-9800		2 OF 2		

6

5

4

3

2

1

D

D

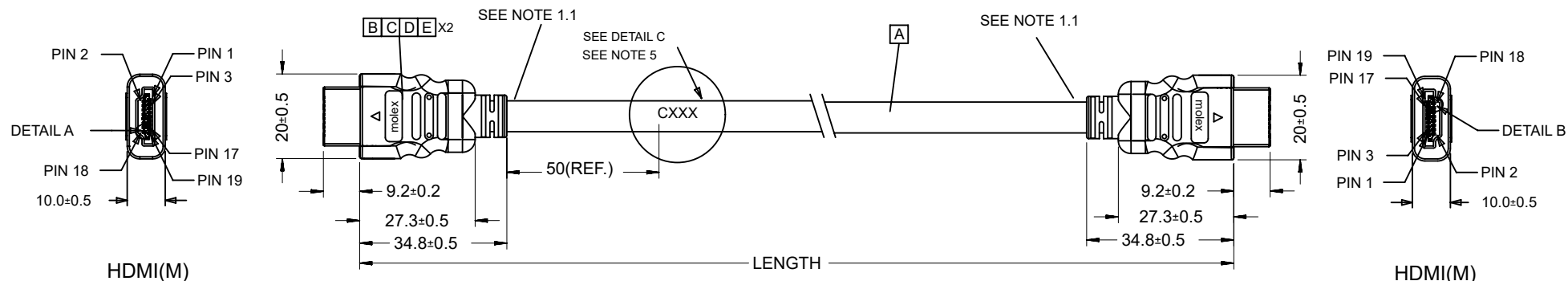

HDMI(M)

HDMI(M)

C

C

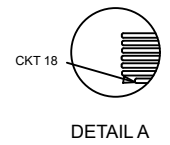

DETAIL A

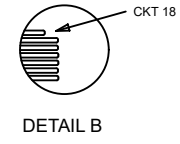

DETAIL B

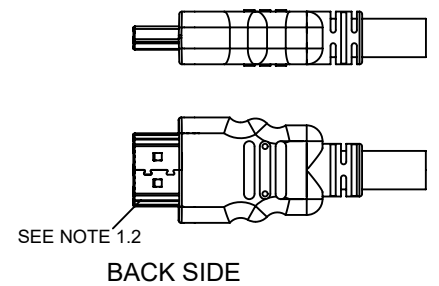

BACK SIDE

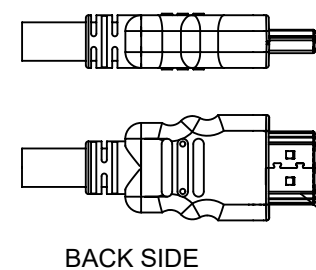

BACK SIDE

B

B

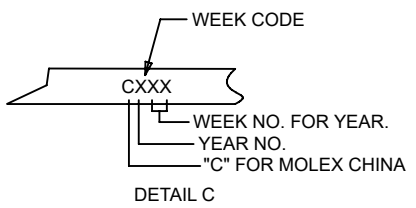

DETAIL C

A

A

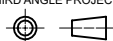
887689810	HDMI TO HDMI CABLE ASS'Y,2M	2000 ± 60	BLACK	7.3MM(TMDS - AWG#28)	172005984
887689800	HDMI TO HDMI CABLE ASS'Y,1M	1000 ± 30	BLACK	7.3MM(TMDS - AWG#28)	172005984
MX P/N	DESCRIPTION	LENGTH	CABLE COLOR	CABLE OD	CABLE P/N
THIS DRAWING CONTAINS INFORMATION THAT IS PROPRIETARY TO MOLEX ELECTRONIC TECHNOLOGIES, LLC AND SHOULD NOT BE USED WITHOUT WRITTEN PERMISSION AS PER PCN#509451					
DIMENSION UNITS		SCALE		CURRENT REV DESC: OBSOLETE PART NUMBER AS PER PCN#509451	
mm		NTS		 <p>HDMI(M) TO HDMI(M) CABLE ASS'Y</p> <p>PRODUCT CUSTOMER DRAWING</p>	
GENERAL TOLERANCES (UNLESS SPECIFIED)					
	MM	INCH			
4 PLACES	±	±			
3 PLACES	±	±			
2 PLACES	±	±			
1 PLACE	±	±			
0 PLACES	±	±			
ANGULAR TOL		± °			
DRAFT WHERE APPLICABLE MUST REMAIN WITHIN DIMENSIONS		THIRD ANGLE PROJECTION	DRAWING	SERIES	MATERIAL NUMBER
			A4-SIZE	88768	SEE TABLE
		DRWN: SUGEEB	2021/09/22	DOCUMENT NUMBER	
		CHK'D: GGA	2022/02/28	SD-88768-9820	
		APPR: GGA	2022/02/28	DOC TYPE	DOC PART
		INITIAL REVISION:		PSD	001
		DRWN: FZHANG01	2011/05/04	REVISION	
		APPR: ZXDENG	2011/05/11	H	
		CUSTOMER		SHEET NUMBER	
		GENERAL MARKET		1 OF 2	

DOCUMENT STATUS	P1	RELEASE DATE	2022/02/28	11:54:02
-----------------	----	--------------	------------	----------

6

5

4

3

2

1

6

5

4

3

2

1

NOTE:

1. OVERMOLD SPECIFICATION :

1.1 HDMI OUTER MOLDED WITH PVC RESIN
HDMI INNER MOLDED WITH PVC RESIN

1.2 DUST COVER MOLDED WITH PE

2. PRODUCT ELECTRICAL SPECIFICATION REFER TO HDMI SPEC.

3. THE CODE PLEASE BE PRINTED ON THE SPACE

4. THIS PRODUCT MUST MEET EU CHEMICAL SUBSTANCE SPECIFICATION FOR PRODUCTS.(EU 2002/95/EC)

WIRE DIAGRAM:

SHIELD	SHIELD	OVERALL SHIELD	GROUND
PIN 19	PIN 19	PINK	HOT PLUG DETECT
PIN 18	PIN 18	ORANGE	+5V POWER
PIN 17	PIN 17	YELLOW	DDC/CEC GROUND
PIN 16	PIN 16	WHITE	SDA
PIN 15	PIN 15	RED	SCL
PIN 14	PIN 14	VIOLET	RESERVED
PIN 13	PIN 13	GRAY	CEC
PIN 12	PIN 12	WHITE	TMDS CLOCK-
PIN 11	PIN 11	BRAID	TMDS CLOCK SHIELD
PIN 10	PIN 10	BLACK	TMDS CLOCK+
PIN 9	PIN 9	WHITE	TMDS DATA 0-
PIN 8	PIN 8	BRAID	TMDS DATA 0 SHIELD
PIN 7	PIN 7	BLUE	TMDS DATA 0+
PIN 6	PIN 6	WHITE	TMDS DATA 1-
PIN 5	PIN 5	BRAID	TMDS DATA 1 SHIELD
PIN 4	PIN 4	GREEN	TMDS DATA 1+
PIN 3	PIN 3	WHITE	TMDS DATA 2-
PIN 2	PIN 2	BRAID	TMDS DATA 2 SHIELD
PIN 1	PIN 1	RED	TMDS DATA 2+
HDMI	HDMI	COLOR	CABLE FUNCTION

E	PRE-CUT C.Foil 47X23mm T=25U 172003402		2
D	COPPER FOIL 172000915		2
C	HDMI 19P MALE;30U"Au Solder Type 172004051		2
B	Metal Shell For HDMI 19P Male 172004052		2
A	(4P+1P)X28+5CX28;ALSH;PVC;BK;7.3;UL20276 (SEE TABLE)		1
ITEM	DESCRIPTION	L	QTY.

THIS DRAWING CONTAINS INFORMATION THAT IS PROPRIETARY TO MOLEX ELECTRONIC TECHNOLOGIES, LLC AND SHOULD NOT BE USED WITHOUT WRITTEN PERMISSION

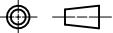
DIMENSION UNITS		SCALE		CURRENT REV DESC: OBSOLETE PART NUMBER AS PER PCN#509451		 HDMI(M) TO HDMI(M) CABLE ASSY									
mm		NTS													
GENERAL TOLERANCES (UNLESS SPECIFIED)						EC NO: 686785 DRWN: SUGEEB 2021/09/22 CHK'D: GGA 2022/02/28 APPR: GGA 2022/02/28 INITIAL REVISION: DRWN: FZHANG01 2011/05/04 APPR: ZXDENG 2011/05/11									
	MM		INCH												
4 PLACES	±		±												
3 PLACES	±		±												
2 PLACES	±		±												
1 PLACE	±		±												
0 PLACES	±		±			PRODUCT CUSTOMER DRAWING DOCUMENT NUMBER SD-88768-9820 DOC TYPE PSD DOC PART 001 REVISION H									
ANGULAR TOL ± °															
DRAFT WHERE APPLICABLE MUST REMAIN WITHIN DIMENSIONS				THIRD ANGLE PROJECTION 		DRAWING A4-SIZE		SERIES 88768		MATERIAL NUMBER SEE TABLE		CUSTOMER GENERAL MARKET		SHEET NUMBER 2 OF 2	

DOCUMENT STATUS	P1	RELEASE DATE	2022/02/28	11:54:02
-----------------	----	--------------	------------	----------

6

5

4

3

2

1

6

5

4

3

2

1

D

D

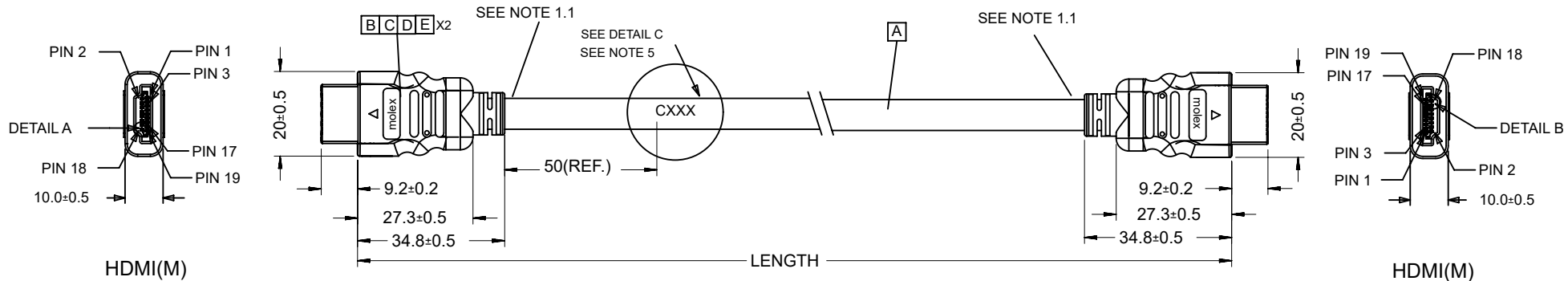

HDMI(M)

HDMI(M)

C

C

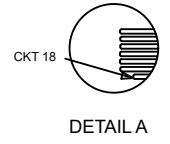

DETAIL A

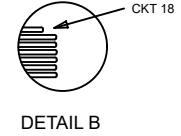

DETAIL B

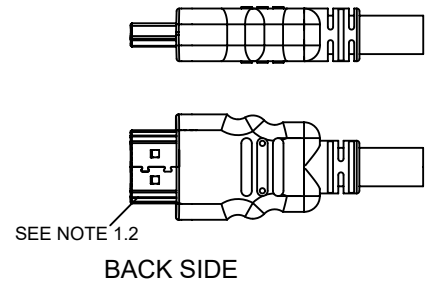

BACK SIDE

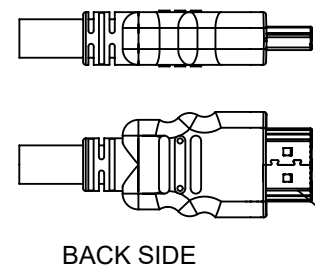

BACK SIDE

B

B

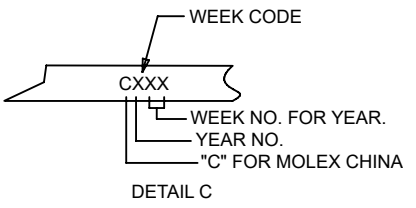

DETAIL C

A

A

887689810	HDMI TO HDMI CABLE ASS'Y,2M	2000 ± 60	BLACK	7.3MM(TMDS - AWG#28)	172005984
887689800	HDMI TO HDMI CABLE ASS'Y,1M	1000 ± 30	BLACK	7.3MM(TMDS - AWG#28)	172005984
MX P/N	DESCRIPTION	LENGTH	CABLE COLOR	CABLE OD	CABLE P/N

THIS DRAWING CONTAINS INFORMATION THAT IS PROPRIETARY TO MOLEX ELECTRONIC TECHNOLOGIES, LLC AND SHOULD NOT BE USED WITHOUT WRITTEN PERMISSION AS PER PCN#509451

DIMENSION UNITS		SCALE		CURRENT REV DESC: OBSOLETE PART NUMBER AS PER PCN#509451				
mm		NTS						
GENERAL TOLERANCES (UNLESS SPECIFIED)						HDMI(M) TO HDMI(M) CABLE ASS'Y PRODUCT CUSTOMER DRAWING		
	MM	INCH						
4 PLACES	±	±	EC NO: 686785					
3 PLACES	±	±	DRWN: SUGEEB 2021/09/21					
2 PLACES	±	±	CHK'D: GGA 2022/02/28					
1 PLACE	±	±	APPR: GGA 2022/02/28					
0 PLACES	±	±	INITIAL REVISION:			DOCUMENT NUMBER		
ANGULAR TOL ± °			DRWN: ZHANG01 2011/05/04			SD-88768-9830		DOC TYPE
DRAFT WHERE APPLICABLE MUST REMAIN WITHIN DIMENSIONS			APPR: ZXDENG 2011/05/11			PSD		DOC PART
			THIRD ANGLE PROJECTION			SERIES		REVISION
			DRAWING			MATERIAL NUMBER		
			A4-SIZE			CUSTOMER		
			88768			GENERAL MARKET		SHEET NUMBER
						SEE TABLE		1 OF 2

DOCUMENT STATUS	P1	RELEASE DATE	2022/02/28	11:54:03
-----------------	----	--------------	------------	----------

6

5

4

3

2

1

6

5

4

3

2

1

NOTE:

1. OVERMOLD SPECIFICATION:

1.1 HDMI OUTER MOLDED WITH PVC RESIN

HDMI INNER MOLDED WITH PVC RESIN

1.2 DUST COVER MOLDED WITH PE

2. PRODUCT ELECTRICAL SPECIFICATION REFER TO HDMI SPEC.

3. THE CODE PLEASE BE PRINTED ON THE SPACE

4. THIS PRODUCT MUST MEET EU CHEMICAL SUBSTANCE SPECIFICATION FOR PRODUCTS.(EU 2002/95/EC)

WIRE DIAGRAM:

SHIELD	SHIELD	OVERALL SHIELD	GROUND
PIN 19	PIN 19	PINK	HOT PLUG DETECT
PIN 18	PIN 18	ORANGE	+5V POWER
PIN 17	PIN 17	YELLOW	DDC/CEC GROUND
PIN 16	PIN 16	WHITE	SDA
PIN 15	PIN 15	RED	SCL
PIN 14	PIN 14	VIOLET	RESERVED
PIN 13	PIN 13	GRAY	CEC
PIN 12	PIN 12	WHITE	TMDS CLOCK-
PIN 11	PIN 11	BRAID	TMDS CLOCK SHIELD
PIN 10	PIN 10	BLACK	TMDS CLOCK+
PIN 9	PIN 9	WHITE	TMDS DATA 0-
PIN 8	PIN 8	BRAID	TMDS DATA 0 SHIELD
PIN 7	PIN 7	BLUE	TMDS DATA 0+
PIN 6	PIN 6	WHITE	TMDS DATA 1-
PIN 5	PIN 5	BRAID	TMDS DATA 1 SHIELD
PIN 4	PIN 4	GREEN	TMDS DATA 1+
PIN 3	PIN 3	WHITE	TMDS DATA 2-
PIN 2	PIN 2	BRAID	TMDS DATA 2 SHIELD
PIN 1	PIN 1	RED	TMDS DATA 2+
HDMI	HDMI	COLOR	CABLE FUNCTION

E	PRE-CUT C.Foil 47X23mm T=25U 172003402		2
D	COPPER FOIL 172000915		2
C	HDMI 19P MALE;30U"Au Solder Type 172004051		2
B	Metal Shell For HDMI 19P Male 172004052		2
A	(4P+1P)X28+5CX28;ALSH;PVC;BK;7.3;UL20276 (SEE TABLE)		1
ITEM	DESCRIPTION	L	QTY.

THIS DRAWING CONTAINS INFORMATION THAT IS PROPRIETARY TO MOLEX ELECTRONIC TECHNOLOGIES, LLC AND SHOULD NOT BE USED WITHOUT WRITTEN PERMISSION

DIMENSION UNITS		SCALE		CURRENT REV DESC: OBSOLETE PART NUMBER AS PER PCN#509451		molex				
mm		NTS				HDMI(M) TO HDMI(M) CABLE ASSY				
GENERAL TOLERANCES (UNLESS SPECIFIED)						PRODUCT CUSTOMER DRAWING				
		MM	INCH							
4 PLACES	±			EC NO: 686785						
3 PLACES	±			DRWN: SUGEEB 2021/09/21						
2 PLACES	±			CHK'D: GGA 2022/02/28						
1 PLACE	±			APPR: GGA 2022/02/28						
0 PLACES	±			INITIAL REVISION:		DOCUMENT NUMBER		DOC TYPE	DOC PART	REVISION
ANGULAR TOL		±	°	DRWN: ZHANG01 2011/05/04		SD-88768-9830		PSD	001	H
DRAFT WHERE APPLICABLE MUST REMAIN WITHIN DIMENSIONS		THIRD ANGLE PROJECTION		DRAWING	SERIES	MATERIAL NUMBER	CUSTOMER		SHEET NUMBER	
				A4-SIZE	88768	SEE TABLE	GENERAL MARKET		2 OF 2	

DOCUMENT STATUS	P1	RELEASE DATE	2022/02/28	11:54:03
-----------------	----	--------------	------------	----------

6

5

4

3

2

1

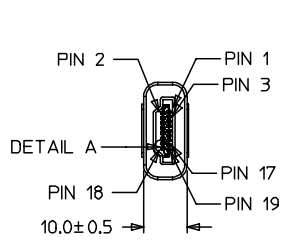

HDMI(M)

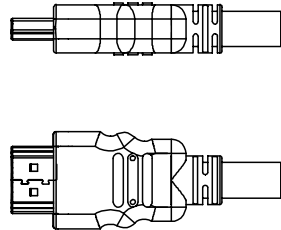
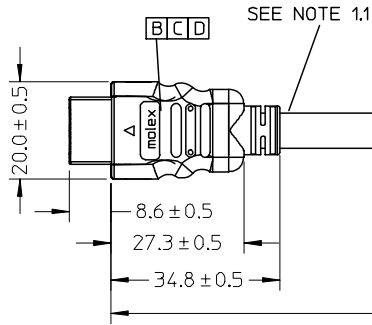
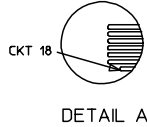

BACK SIDE

LENGTH

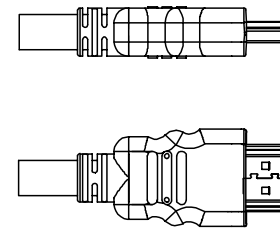
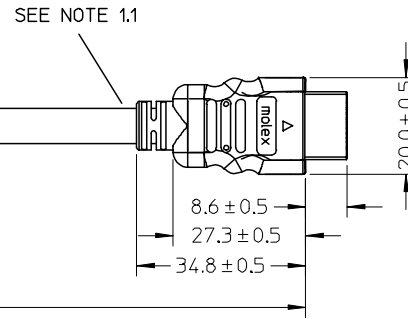

BACK SIDE

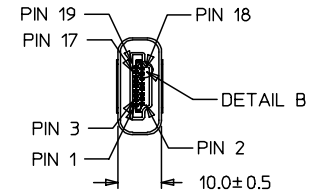

HDMI(M)

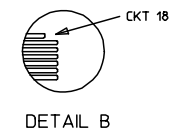

88768-9830	HDMI TO HDMI CABLE ASS'Y,5M	5000 ± 100	BLACK	7.3MM(TMDS - AWG#28)	887808610
88768-9820	HDMI TO HDMI CABLE ASS'Y,3M	3000 ± 80	BLACK	7.3MM(TMDS - AWG#28)	887808610
88768-9810	HDMI TO HDMI CABLE ASS'Y,2M	2000 ± 60	BLACK	7.3MM(TMDS - AWG#28)	887808610
88768-9800	HDMI TO HDMI CABLE ASS'Y,1M	1000 ± 30	BLACK	7.3MM(TMDS - AWG#28)	887808610
MX P/N	DESCRIPTION	LENGTH	CABLE COLOR	CABLE OD	CABLE P/N

ENTER DESCRIPTION EC NO: DG2006-0144 DRAWN: JFZHENG CHKD: APPR: DQLUO	2005/12/27 2005/12/30 2006/01/16
REV	DESCRIPTION

QUALITY SYMBOLS
▽=0
∇=0

GENERAL TOLERANCES (UNLESS SPECIFIED)	
	mm
	INCH
4 PLACES	± ---
3 PLACES	± ---
2 PLACES	± ---
1 PLACE	± ---
ANGULAR ± ---°	
DRAFT WHERE APPLICABLE MUST REMAIN WITHIN DIMENSIONS	

DIMENSION STYLE	
MM ONLY	
DRAWN BY	DATE
JFZHENG	2005/12/26
CHECKED BY	DATE
JFZHENG	2005/12/26
APPROVED BY	DATE
DQLUO	2005/12/26
MATERIAL NO.	DOCUMENT NO.
ENTER PART	SD-887689800
SIZE	
A 4	

SCALE	DESIGN UNITS	THIRD ANGLE PROJECTION
---	METRIC	
TITLE		
AWG28 HDMI TO HDMI CABLE ASS'Y		
MOLEX MOLEX INCORPORATED		
SHEET NO.		1 OF 00

NOTE:

1. OVMOLD SPECIFICATION:
 - 1.1 HDMI INNERMOLD WITH BK PVC 887800019.
 - 1.2 HDMI OVERMOLD WITH PVC 887800150.
2. MECHANICAL SPECIFICATION:

CABLE SHOULD STAND THE PULL FORCE 89-111N FOR 30 SECONDS WITH NO VISIBLE TERMINATION DAMAGE.

3. PRODUCT ELECTRICAL SPECIFICATION:

- 3.1 DIELECTRIC STRENGTH.
- 3.2 INSULATION RESISTANCE
- 3.3 CONDUCTIVE RESISTANCE.
- 3.4 TMDS Signals Time Domain Impedence
- 3.5 TMDS Signals Time Domain Crosstalk:FEXT
- 3.6 TMDS Signals Skew
- 3.7 Attenuation(

REFER TO ES-002 ELECTRICAL SPECIFICATION FOR DETAILS.

4.CABLE CONSTRUCTION



(AWG#28*1P+D)*4 + AWG#28*1P + AWG#28*5C, 7.3MMOD

5. THIS PRODUCT MUST MEET ROHS COMPLIANCE.

WIRE DIAGRAM:

SHIELD	SHIELD	OVERALL SHIELD	GROUND
PIN 19	PIN 19	PINK	HOT PLUG DETECT
PIN 18	PIN 18	ORANGE	+5V POWER
PIN 17	PIN 17	YELLOW	DDC/CEC GROUND
PIN 16	PIN 16	WHITE	SDA
PIN 15	PIN 15	RED	SCL
PIN 14	PIN 14	VIOLET	RESERVED
PIN 13	PIN 13	GRAY	CEC
PIN 12	PIN 12	WHITE	TMDS CLOCK-
PIN 11	PIN 11	BRAID	TMDS CLOCK SHIELD
PIN 10	PIN 10	WHITE/BLACK	TMDS CLOCK+
PIN 9	PIN 9	WHITE	TMDS DATA 0-
PIN 8	PIN 8	BRAID	TMDS DATA 0 SHIELD
PIN 7	PIN 7	WHITE/BLUE	TMDS DATA 0+
PIN 6	PIN 6	WHITE	TMDS DATA 1-
PIN 5	PIN 5	BRAID	TMDS DATA 1 SHIELD
PIN 4	PIN 4	WHITE/GREEN	TMDS DATA 1+
PIN 3	PIN 3	WHITE	TMDS DATA 2-
PIN 2	PIN 2	BRAID	TMDS DATA 2 SHIELD
PIN 1	PIN 1	WHITE/RED	TMDS DATA 2+
HDMI	HDMI	COLOR	CABLE FUNCTION

D	SMALL METAL PLATE 47152-6009		2
C	HDMI METAL CAN 47152-4001		2
B	HDMI HOUSING ASSY' 47152-1100		2
A	HDMI SINGLE LINK CABLE (SEE TABLE)		1
ITEM	DESCRIPTION	L	QTY.

ENTER DESCRIPTION EC NO: DG2006-0144 TDRWN: JFZHENG 2005/12/27 CHKD: 2005/12/30 APPR: DQLUO 2006/01/16	QUALITY SYMBOLS  = 0  = 0	GENERAL TOLERANCES (UNLESS SPECIFIED)		DIMENSION STYLE		SCALE	DESIGN UNITS	THIRD ANGLE PROJECTION		
				MM ONLY		---	METRIC			
		4 PLACES	± ---	± ---	DRAWN BY	DATE	TITLE			
		3 PLACES	± ---	± ---	JFZHENG	2005/12/26	AWG28 HDMI TO HDMI CABLE ASS'Y			
2 PLACES	± ---	± ---	CHECKED BY	DATE						
1 PLACE	± ---	± ---	JFZHENG	2005/12/26						
ANGULAR ± ---°		APPROVED BY		DATE	MOLEX MOLEX INCORPORATED					
		DQLUO		2005/12/26						
DRAFT WHERE APPLICABLE MUST REMAIN WITHIN DIMENSIONS		MATERIAL NO.		DOCUMENT NO.	SHEET NO.					
		ENTER PART		SD-887689800	2 OF 00					
		SIZE		THIS DRAWING CONTAINS INFORMATION THAT IS PROPRIETARY TO MOLEX INCORPORATED AND SHOULD NOT BE USED WITHOUT WRITTEN PERMISSION						
		A 4								

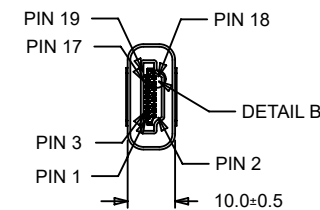
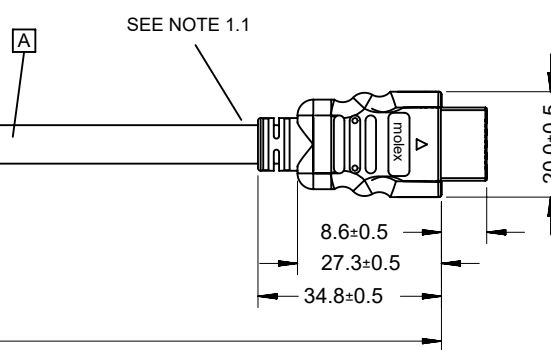
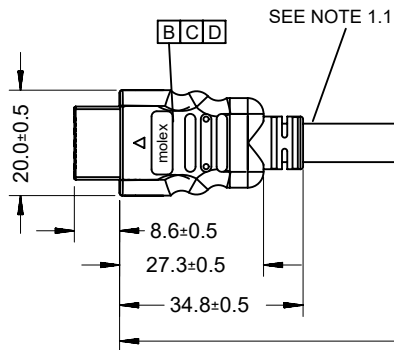
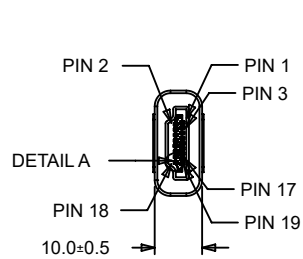

HDMI(M)

HDMI(M)

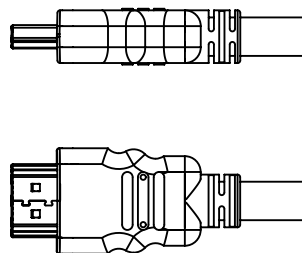
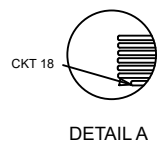

BACK SIDE

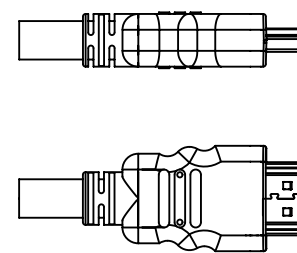

BACK SIDE

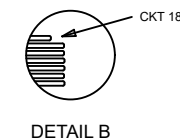

DETAIL B

88768-9810	HDMI TO HDMI CABLE ASS'Y,2M	2000 ± 60	BLACK	7.3MM(TMDS - AWG#28)	887808610
88768-9800	HDMI TO HDMI CABLE ASS'Y,1M	1000 ± 30	BLACK	7.3MM(TMDS - AWG#28)	887808610
MX P/N	DESCRIPTION	LENGTH	CABLE COLOR	CABLE OD	CABLE P/N

THIS DRAWING CONTAINS INFORMATION THAT IS PROPRIETARY TO MOLEX ELECTRONIC TECHNOLOGIES, LLC AND SHOULD NOT BE USED WITHOUT WRITTEN PERMISSION AS PER PCN#509451

DIMENSION UNITS		SCALE		CURRENT REV DESC: OBSOLETE PART NUMBER AS PER PCN#509451						
mm		NTS								
GENERAL TOLERANCES (UNLESS SPECIFIED)						AWG28 HDMI TO HDMI CABLE ASS'Y PRODUCT CUSTOMER DRAWING				
	MM	INCH								
4 PLACES	±	±	EC NO: 686785							
3 PLACES	±	±	DRWN: SUGEEB 2021/09/21							
2 PLACES	±	±	CHK'D: GGA 2022/02/28							
1 PLACE	±	±	APPR: GGA 2022/02/28							
0 PLACES	±	±	INITIAL REVISION:			DOCUMENT NUMBER				
ANGULAR TOL		±	°	DRWN: JFZHENG 2005/12/26		SD-887689820		DOC TYPE	DOC PART	REVISION
DRAFT WHERE APPLICABLE MUST REMAIN WITHIN DIMENSIONS		THIRD ANGLE PROJECTION		DRAWING	SERIES	MATERIAL NUMBER	CUSTOMER	SHEET NUMBER		
				A4-SIZE	88768	SEE TABLE	GENERAL MARKET	1 OF 2		

DOCUMENT STATUS	P1	RELEASE DATE	2022/02/28	11:54:05
-----------------	----	--------------	------------	----------

6

5

4

3

2

1

NOTE:

1. OVMEMROLD SPECIFICATION:

- 1.1 HDMI INNERMOLD WITH BK PVC 887800019.
- 1.2 HDMI OVERMOLD WITH PVC 887800150.

2. MECHANICAL SPECIFICATION:

CABLE SHOULD STAND THE PULL FORCE 89-111N FOR 30 SECONDS WITH NO VISIBLE TERMINATION DAMAGE.

3. PRODUCT ELECTRICAL SPECIFICATION:

- 3.1 DIELECTRIC STRENGTH.
- 3.2 INSULATION RESISTANCE
- 3.3 CONDUCTIVE RESISTANCE.
- 3.4 TMDS Signals Time Domain Impedence
- 3.5 TMDS Signals Time Domain Crosstalk:FEXT
- 3.6 TMDS Signals Skew
- 3.7 Attenuation(
REFER TO ES-002 ELECTRICAL SPECIFICATION FOR DETAILS.

4.CABLE CONSTRUCTION

(AWG#28*1P+D)*4 + AWG#28*1P + AWG#28*5C, 7.3MMOD

5. THIS PRODUCT MUST MEET ROHS COMPLIANCE.

WIRE DIAGRAM:

SHIELD	SHIELD	OVERALL SHIELD	GROUND
PIN 19	PIN 19	PINK	HOT PLUG DETECT
PIN 18	PIN 18	ORANGE	+5V POWER
PIN 17	PIN 17	YELLOW	DDC/CEC GROUND
PIN 16	PIN 16	WHITE	SDA
PIN 15	PIN 15	RED	SCL
PIN 14	PIN 14	VIOLET	RESERVED
PIN 13	PIN 13	GRAY	CEC
PIN 12	PIN 12	WHITE	TMDS CLOCK-
PIN 11	PIN 11	BRAID	TMDS CLOCK SHIELD
PIN 10	PIN 10	WHITE/BLACK	TMDS CLOCK+
PIN 9	PIN 9	WHITE	TMDS DATA 0-
PIN 8	PIN 8	BRAID	TMDS DATA 0 SHIELD
PIN 7	PIN 7	WHITE/BLUE	TMDS DATA 0+
PIN 6	PIN 6	WHITE	TMDS DATA 1-
PIN 5	PIN 5	BRAID	TMDS DATA 1 SHIELD
PIN 4	PIN 4	WHITE/GREEN	TMDS DATA 1+
PIN 3	PIN 3	WHITE	TMDS DATA 2-
PIN 2	PIN 2	BRAID	TMDS DATA 2 SHIELD
PIN 1	PIN 1	WHITE/RED	TMDS DATA 2+
HDMI	HDMI	COLOR	CABLE FUNCTION

D	SMALL METAL PLATE 47152-6009		2
C	HDMI METAL CAN 47152-4001		2
B	HDMI HOUSING ASSY' 47152-1100		2
A	HDMI SINGLE LINK CABLE (SEE TABLE)		1
ITEM	DESCRIPTION	L	QTY.

THIS DRAWING CONTAINS INFORMATION THAT IS PROPRIETARY TO MOLEX ELECTRONIC TECHNOLOGIES, LLC AND SHOULD NOT BE USED WITHOUT WRITTEN PERMISSION									
DIMENSION UNITS		SCALE		CURRENT REV DESC: OBSOLETE PART NUMBER AS PER PCN#509451				molex	
mm		NTS							
GENERAL TOLERANCES (UNLESS SPECIFIED)				EC NO: 686785 DRWN: SUGEEB 2021/09/21 CHK'D: GGA 2022/02/28 APPR: GGA 2022/02/28				AWG28 HDMI TO HDMI CABLE ASS'Y	
	MM	INCH							
4 PLACES	±	±							
3 PLACES	±	±							
2 PLACES	±	±							
1 PLACE	±	±							
0 PLACES	±	±							
ANGULAR TOL ± °				INITIAL REVISION:				DOCUMENT NUMBER	
DRAFT WHERE APPLICABLE MUST REMAIN WITHIN DIMENSIONS				THIRD ANGLE PROJECTION		DRAWING		SERIES	
						A4-SIZE		88768	
						MATERIAL NUMBER		CUSTOMER	
						SEE TABLE		GENERAL MARKET	
								SHEET NUMBER	
								2 OF 2	

DOCUMENT STATUS	P1	RELEASE DATE	2022/02/28	11:54:05
-----------------	----	--------------	------------	----------

6

5

4

3

2

1

6

5

4

3

2

1

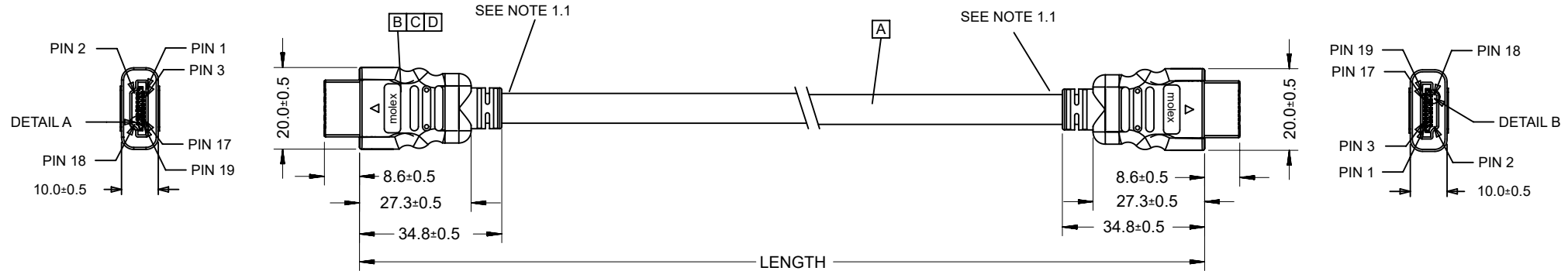

HDMI(M)

HDMI(M)

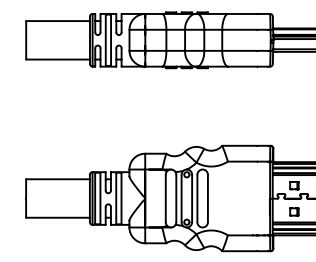
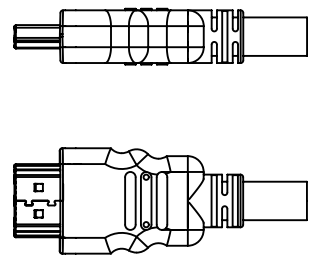
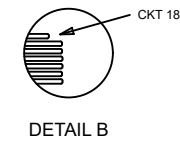
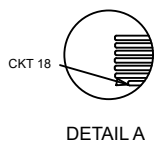

BACK SIDE

BACK SIDE

PRE-RELEASE REFERENCE USE ONLY

88768-9810	HDMI TO HDMI CABLE ASS'Y,2M	2000 ± 60	BLACK	7.3MM(TMDS - AWG#28)	887808610
88768-9800	HDMI TO HDMI CABLE ASS'Y,1M	1000 ± 30	BLACK	7.3MM(TMDS - AWG#28)	887808610
MX P/N	DESCRIPTION	LENGTH	CABLE COLOR	CABLE OD	CABLE P/N

THIS DRAWING CONTAINS INFORMATION THAT IS PROPRIETARY TO MOLEX ELECTRONIC TECHNOLOGIES, LLC AND SHOULD NOT BE USED WITHOUT WRITTEN PERMISSION AS PER PCN#509451

DIMENSION UNITS	SCALE	CURRENT REV DESC: OBSOLETE PART NUMBER AS PER PCN#509451
mm	NTS	
GENERAL TOLERANCES (UNLESS SPECIFIED)		
	MM	INCH
4 PLACES	±	±
3 PLACES	±	±
2 PLACES	±	±
1 PLACE	±	±
0 PLACES	±	±
ANGULAR TOL	±	°

EC NO: 686785
 DRWN: SUGEEB 2021/09/21
 CHK'D: GGA 2022/02/28
 APPR: GGA 2022/02/28

INITIAL REVISION:
 DRWN: JFZHENG 2005/12/26
 APPR: DQLUO 2005/12/26

molex

AWG28 HDMI TO HDMI CABLE ASS'Y

PRODUCT CUSTOMER DRAWING

DOCUMENT NUMBER	DOC TYPE	DOC PART	REVISION
SD-887689830	PSD	001	G

DOCUMENT STATUS	P1	RELEASE DATE	2022/02/28	11:54:07
-----------------	----	--------------	------------	----------

DRAFT WHERE APPLICABLE MUST REMAIN WITHIN DIMENSIONS	THIRD ANGLE PROJECTION	DRAWING	SERIES	MATERIAL NUMBER	CUSTOMER	SHEET NUMBER
		A4-SIZE	88768	SEE TABLE	GENERAL MARKET	1 OF 2

6

5

4

3

2

1

6

5

4

3

2

1

NOTE:

1. OVEMROLD SPECIFICATION:

- 1.1 HDMI INNERMOLD WITH BK PVC 887800019.
- 1.2 HDMI OVERMOLD WITH PVC 887800150.

2. MECHANICAL SPECIFICATION:

CABLE SHOULD STAND THE PULL FORCE 89-111N FOR 30 SECONDS WITH NO VISIBLE TERMINATION DAMAGE.

3. PRODUCT ELECTRICAL SPECIFICATION:

- 3.1 DIELECTRIC STRENGTH.
 - 3.2 INSULATION RESISTANCE
 - 3.3 CONDUCTIVE RESISTANCE.
 - 3.4 TMDS Signals Time Domain Impedence
 - 3.5 TMDS Signals Time Domain Crosstalk:FEXT
 - 3.6 TMDS Signals Skew
 - 3.7 Attenuation(
- REFER TO ES-002 ELECTRICAL SPECIFICATION FOR DETAILS.

4. CABLE CONSTRUCTION

(AWG#28*1P+D)*4 + AWG#28*1P + AWG#28*5C, 7.3MMOD

5. THIS PRODUCT MUST MEET ROHS COMPLIANCE.

WIRE DIAGRAM:

SHIELD	SHIELD	OVERALL SHIELD	GROUND
PIN 19	PIN 19	PINK	HOT PLUG DETECT
PIN 18	PIN 18	ORANGE	+5V POWER
PIN 17	PIN 17	YELLOW	DDC/CEC GROUND
PIN 16	PIN 16	WHITE	SDA
PIN 15	PIN 15	RED	SCL
PIN 14	PIN 14	VIOLET	RESERVED
PIN 13	PIN 13	GRAY	CEC
PIN 12	PIN 12	WHITE	TMDS CLOCK-
PIN 11	PIN 11	BRAID	TMDS CLOCK SHIELD
PIN 10	PIN 10	WHITE/BLACK	TMDS CLOCK+
PIN 9	PIN 9	WHITE	TMDS DATA 0-
PIN 8	PIN 8	BRAID	TMDS DATA 0 SHIELD
PIN 7	PIN 7	WHITE/BLUE	TMDS DATA 0+
PIN 6	PIN 6	WHITE	TMDS DATA 1-
PIN 5	PIN 5	BRAID	TMDS DATA 1 SHIELD
PIN 4	PIN 4	WHITE/GREEN	TMDS DATA 1+
PIN 3	PIN 3	WHITE	TMDS DATA 2-
PIN 2	PIN 2	BRAID	TMDS DATA 2 SHIELD
PIN 1	PIN 1	WHITE/RED	TMDS DATA 2+
HDMI	HDMI	COLOR	CABLE FUNCTION

PRE-RELEASE
REFERENCE
USE ONLY

D	SMALL METAL PLATE 47152-6009		2
C	HDMI METAL CAN 47152-4001		2
B	HDMI HOUSING ASSY' 47152-1100		2
A	HDMI SINGLE LINK CABLE (SEE TABLE)		1
ITEM	DESCRIPTION	L	QTY.

THIS DRAWING CONTAINS INFORMATION THAT IS PROPRIETARY TO MOLEX ELECTRONIC TECHNOLOGIES, LLC AND SHOULD NOT BE USED WITHOUT WRITTEN PERMISSION AS PER PCN#509451

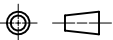
DIMENSION UNITS		SCALE		CURRENT REV DESC: OBSOLETE PART NUMBER AS PER PCN#509451					
mm	NTS	MM	INCH						
GENERAL TOLERANCES (UNLESS SPECIFIED)				EC NO: 686785		AWG28 HDMI TO HDMI CABLE ASS'Y PRODUCT CUSTOMER DRAWING			
4 PLACES	±			DRWN: SUGEEB 2021/09/21					
3 PLACES	±			CHK'D: GGA 2022/02/28					
2 PLACES	±			APPR: GGA 2022/02/28					
1 PLACE	±			INITIAL REVISION:		DOCUMENT NUMBER	DOC TYPE	DOC PART	REVISION
0 PLACES	±			DRWN: JFZHENG 2005/12/26		SD-887689830	PSD	001	G
ANGULAR TOL		±	°	APPR: DQLUO 2005/12/26		MATERIAL NUMBER		CUSTOMER	
DRAFT WHERE APPLICABLE MUST REMAIN WITHIN DIMENSIONS		THIRD ANGLE PROJECTION		DRAWING	SERIES	MATERIAL NUMBER		SHEET NUMBER	
				A4-SIZE	88768	SEE TABLE		GENERAL MARKET 2 OF 2	

DOCUMENT STATUS	P1	RELEASE DATE	2022/02/28	11:54:07
-----------------	----	--------------	------------	----------

6

5

4

3

2

1