

Dual 150mA CMOS LDO With Select Mode™ Operation, Shutdown and Independent RESET Output

Features

- Extremely Low Supply Current for Longer Battery Life
- Select Mode™ Operation: Selectable Output Voltages for High Design Flexibility
- Very Low Dropout Voltage
- $29\mu V_{RMS}$ Typical Output Noise
- 10 μ sec (Typ.) Wake-Up Time from \overline{SHDN}
- 150mA Output Current per Output
- High Output Voltage Accuracy
- Power-Saving Shutdown Mode
- \overline{RESET} Output Can Be Used as a Low Battery Detector or Processor Reset Generator
- Over Current Protection and Over Temperature Shutdown
- Space Saving 10-Pin MSOP Package

Applications

- Load Partitioning
- Battery Operated Systems
- Portable Computers
- Medical Instruments
- Instrumentation
- Pagers and Cellular/PHS Phones
- Linear Post-Regulator for SMPS

Device Selection Table

Part Number	Package	Junction Temperature Range
TC1305R-DVUN	10-Pin MSOP	-40°C to +85°C

NOTE: "R" denotes the suffix for the 2.63V V_{DET} threshold.
 "D" indicates $V_{OUT1} = V_{OUT2} = 2.5, 2.8, 3.0$ (selectable).
 Other output voltages are available. Please contact Microchip Technology Inc. for details.

Package Type

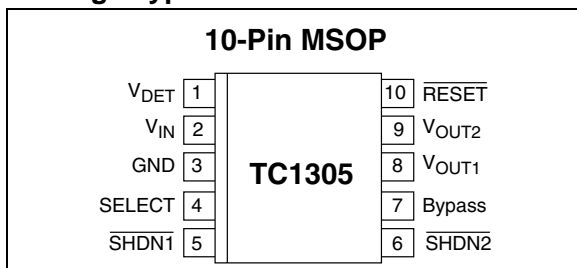

General Description

The TC1305 combines two CMOS Low Dropout Regulators and a Microprocessor Monitor in a space saving 10-Pin MSOP package. Designed specifically for battery operated systems, total supply current is typically 120 μ A at full load, 20 to 60 times lower than in bipolar regulators.

The TC1305 features selectable output voltages for higher design flexibility. The tri-state SELECT input pin allows the user to select V_{OUT1} and V_{OUT2} from 3 different values (2.5V, 2.8V and 3.0V).

An active low \overline{RESET} is asserted when the detected voltage (V_{DET}) falls below the 2.63V reset voltage threshold. The RESET output remains low for 300msec (typical) after V_{DET} rises above reset threshold. When the shutdown controls ($\overline{SHDN1}$ and $\overline{SHDN2}$) are low, the regulator output voltages fall to zero, \overline{RESET} output remains valid and supply current is reduced to 20 μ A (typ.)

Other key features for the device include ultra low noise operation, fast response to step changes in load and very low dropout voltage (typically 150mV at full load). The device also incorporates both over temperature and over current protection. Each regulator is stable with an output capacitor of only 1 μ F and has a maximum output current of 150mA. The TC1305 is featured in a 10-Pin MSOP package with selective output voltages.

Typical Application

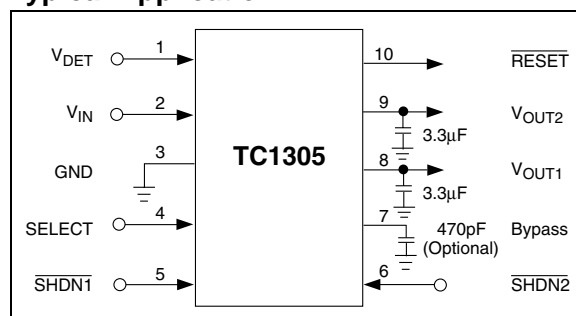

TC1305

1.0 ELECTRICAL CHARACTERISTICS

ABSOLUTE MAXIMUM RATINGS*

Input Voltage	6.5V
Output Voltage.....	(-0.3V) to (V _{IN} + 0.3V)
Power Dissipation.....	Internally Limited (Note 7)
Maximum Voltage on Any Pin	V _{IN} + 0.3V to -0.3V
Operating Temperature Range....	-40°C < T _J < +125°C
Storage Temperature Range	-55°C to +150°C

*Stresses above those listed under "Absolute Maximum Ratings" may cause permanent damage to the device. These are stress ratings only and functional operation of the device at these or any other conditions above those indicated in the operation sections of the specifications is not implied. Exposure to Absolute Maximum Rating conditions for extended periods may affect device reliability.

TC1305 ELECTRICAL SPECIFICATIONS

Electrical Characteristics: V_{IN} = V_R + 1V, I_L = 100μA, C_L = 3.3μF, SHDN1 > V_{IH}, SHDN2 > V_{IH}, T_A = 25°C, unless otherwise noted. **Boldface** type specifications apply for junction temperature of -40°C to +125°C. Applies to both V_{OUT1} and V_{OUT2}.

Symbol	Parameter	Min	Typ	Max	Units	Test Conditions
V _{IN}	Input Operating Voltage	2.7	—	6.0	V	Note 1
I _{OUTMAX}	Maximum Output Current	150	—	—	mA	Per Channel
V _{OUT}	Output Voltage (V _{OUT1} and V _{OUT2})	V_R - 2.5%	V _R ± 0.5%	V_R + 2.5%	V	Note 2
TCV _{OUT}	V _{OUT} Temperature Coefficient	—	20 40	—	ppm/°C	Note 3
ΔV _{OUT} /ΔV _{IN}	Line Regulation	—	0.05	0.35	%	(V _R + 1V) ≤ V _{IN} ≤ 6V
ΔV _{OUT} /V _{OUT}	Load Regulation	—	0.5	2	%	I _L = 0.1mA to I _{OUTMAX} (Note 4)
V _{IN} - V _{OUT}	Dropout Voltage	—	2 50 100 150	— 120 240 360	mV	I _L = 100μA I _L = 50mA I _L = 100mA I _L = 150mA (Note 5)
I _{IN}	Supply Current	—	120	160	μA	SHDN1, SHDN2 = V _{IH} , I _L = 0
I _{INSD}	Shutdown Supply Current	—	0.05	0.5	μA	SHDN1, SHDN2 = 0V
PSRR	Power Supply Rejection Ratio	—	64	—	dB	F _{RE} ≤ 120Hz
I _{OUTSC}	Output Short Circuit Current	—	600	—	mA	V _{OUT} = 0V
ΔV _{OUT} /ΔP _D	Thermal Regulation	—	0.04	—	V/W	Notes 6, 7
t _{WK}	Wake Up Time (from Shutdown Mode)	—	10	—	μsec	V _{IN} = 5V C _{IN} = 1μF, C _{OUT} = 4.7μF I _L = 30mA, (See Figure 4-1)
ts	Settling Time (from Shutdown Mode)	—	40	—	μsec	V _{IN} = 5V C _{IN} = 1μF, C _{OUT} = 4.7μF I _L = 30mA, (See Figure 4-1)

Note 1: The minimum V_{IN} has to meet two conditions: V_{IN} ≥ 2.7 and V_{IN} ≥ V_R + V_{DROPOUT}.

Note 2: V_R is the regulator output voltage setting. For example: V_R = 2.5V, 2.8V, 3.0V.

Note 3: $TC V_{OUT} = \frac{(V_{OUTMAX} - V_{OUTMIN})}{V_{OUT}} \times 10^5$

Note 4: Regulation is measured at a constant junction temperature using low duty cycle pulse testing. Load regulation is tested over a load range from 0.1mA to the maximum specified output current. Changes in output voltage due to heating effects are covered by the thermal regulation specification.

Note 5: Dropout voltage is defined as the input to output differential at which the output voltage drops 2% below its nominal value measured at a 1V differential.

Note 6: Thermal Regulation is defined as the change in output voltage at a time T after a change in power dissipation is applied, excluding load or line regulation effects. Specifications are for a current pulse equal to I_{LMAX} at V_{IN} = 6V for T = 10 msec.

Note 7: The maximum allowable power dissipation is a function of ambient temperature, the maximum allowable junction temperature and the thermal resistance from junction-to-air (i.e., T_A, T_J, θ_{JA}). Exceeding the maximum allowable power dissipation causes the device to initiate thermal shutdown. Please see Section 5.0 Thermal Considerations section of this data sheet for more details.

TC1305 ELECTRICAL SPECIFICATIONS (CONTINUED)

Electrical Characteristics: $V_{IN} = V_R + 1V$, $I_L = 100\mu A$, $C_L = 3.3\mu F$, $\overline{SHDN1} > V_{IH}$, $\overline{SHDN2} > V_{IH}$, $T_A = 25^\circ C$, unless otherwise noted. **Boldface** type specifications apply for junction temperature of $-40^\circ C$ to $+125^\circ C$. Applies to both V_{OUT1} and V_{OUT2} .

Symbol	Parameter	Min	Typ	Max	Units	Test Conditions
T_{SD}	Thermal Shutdown Die Temperature	—	160	—	$^\circ C$	
ΔT_{SD}	Thermal Shutdown Hysteresis	—	15	—	$^\circ C$	
eN	Output Noise	—	200	—	nV \sqrt{Hz}	$I_L = 100\mu A$, $F = 1kHz$, $C_{OUT1} = C_{OUT2} = 4.7\mu F$, $C_{BYPASS} = 0.01\mu F$
		—	29	—	μV_{RMS}	
SHDN Input						
V_{IH}	\overline{SHDN} Input High Threshold	65	—	—	% V_{IN}	$V_{IN} = 2.7V$ to $6.0V$
V_{IL}	\overline{SHDN} Input Low Threshold	—	—	15	% V_{IN}	$V_{IN} = 2.7V$ to $6.0V$
SELECT Input						
V_{SELH}	SELECT Input High Threshold	$V_{IN} - 0.2$	—	—	V	$V_{IN} = 2.7V$ to $6.0V$
V_{SELL}	SELECT Input Low Threshold	—	—	0.2	V	$V_{IN} = 2.7V$ to $6.0V$
RESET Output						
V_{DET}	V_{DET} Voltage Range	1.0	—	6.0	V	$T_A = 0^\circ C$ to $+70^\circ C$ $T_A = -40^\circ C$ to $+125^\circ C$
		1.2	—	6.0		
V_{TH}	Reset Threshold	2.59	2.63	2.66	V	$T_A = +25^\circ C$ $T_A = -40^\circ C$ to $+125^\circ C$
		2.55	—	2.70		
I_{VDET}	Reset Circuit Supply Current	—	20	40	μA	$\overline{RESET} = \text{Open}$
	Reset Threshold Tempco	—	30	—	ppm/ $^\circ C$	
	V_{DET} to Reset Delay	—	100	—	μsec	$V_{DET} = V_{TH}$ to $(V_{TH} - 100mV)$
	Reset Active Time-out Period	140	300	560	msec	
V_{OL}	RESET Output Voltage Low	—	—	0.3	V	$V_{DET} = V_{THMIN}$, $I_{SINK} = 1.2mA$ $V_{DET} = V_{THMIN}$, $I_{SINK} = 3.2mA$ $V_{DET} > 1.0V$, $I_{SINK} = 50\mu A$
		—	—	0.4		
		—	—	0.3		
V_{OH}	\overline{RESET} Output Voltage High	$0.8 V_{DET}$ $V_{DET} - 1.5$	—	—	V	$V_{DET} > V_{THMAX}$, $I_{SOURCE} = 500\mu A$ $V_{DET} > V_{THMAX}$, $I_{SOURCE} = 800\mu A$

Note 1: The minimum V_{IN} has to meet two conditions: $V_{IN} \geq 2.7$ and $V_{IN} \geq V_R + V_{DROPOUT}$.

Note 2: V_R is the regulator output voltage setting. For example: $V_R = 2.5V, 2.8V, 3.0V$.

Note 3: $T_C V_{OUT} = \frac{(V_{OUTMAX} - V_{OUTMIN}) \times 10^6}{V_{OUT} \times \Delta T}$

Note 4: Regulation is measured at a constant junction temperature using low duty cycle pulse testing. Load regulation is tested over a load range from 0.1mA to the maximum specified output current. Changes in output voltage due to heating effects are covered by the thermal regulation specification.

Note 5: Dropout voltage is defined as the input to output differential at which the output voltage drops 2% below its nominal value measured at a 1V differential.

Note 6: Thermal Regulation is defined as the change in output voltage at a time T after a change in power dissipation is applied, excluding load or line regulation effects. Specifications are for a current pulse equal to I_{LMAX} at $V_{IN} = 6V$ for $T = 10$ msec.

Note 7: The maximum allowable power dissipation is a function of ambient temperature, the maximum allowable junction temperature and the thermal resistance from junction-to-air (i.e., T_A, T_J, θ_{JA}). Exceeding the maximum allowable power dissipation causes the device to initiate thermal shutdown. Please see Section 5.0 Thermal Considerations section of this data sheet for more details.

TC1305

2.0 PIN DESCRIPTIONS

The descriptions of the pins are listed in Table 2-1.

TABLE 2-1: PIN FUNCTION TABLE

Pin No. (10-Pin MSOP)	Symbol	Description
1	V_{DET}	Detected input voltage. V_{DET} and V_{IN} can be connected together.
2	V_{IN}	Power supply input.
3	GND	Ground terminal.
4	SELECT	Tri-state input for setting V_{OUT1} and V_{OUT2} . SELECT = GND for $V_{OUT1} = V_{OUT2} = 2.5V$, SELECT = V_{IN} for $V_{OUT1} = V_{OUT2} = 3.0V$ and SELECT = No connect for $V_{OUT1} = V_{OUT2} = 2.8V$.
5	$\overline{SHDN1}$	Shutdown control input for V_{OUT1} . Regulator 1 is fully enabled when a logic high is applied to this input. Regulator 1 enters shutdown when a logic low is applied to this input. During shutdown, regulator output voltage falls to zero, \overline{RESET} output remains valid.
6	$\overline{SHDN2}$	Shutdown control input for V_{OUT2} . Regulator 2 is fully enabled when a logic high is applied to this input. Regulator 2 enters shutdown when a logic low is applied to this input. During shutdown, regulator output voltage falls to zero, \overline{RESET} output remains valid.
7	Bypass	Reference bypass input. Connecting a 0.01 μ F to this input further reduces output noise.
8	V_{OUT1}	Regulated voltage output 1.
9	V_{OUT2}	Regulated voltage output 2.
10	\overline{RESET}	\overline{RESET} Output. \overline{RESET} = Low when V_{DET} is below the Reset Threshold Voltage. \overline{RESET} = High when V_{DET} is above the Reset Threshold Voltage.

3.0 DETAILED DESCRIPTION

The TC1305 is a precision fixed output voltage regulator that contains two fully independent 150mA regulator outputs. The device features separate shutdown modes for low-power operation, and a common bypass pin that can be used to further reduce output noise. The Select Mode™ operation allows the user to select V_{OUT1} and V_{OUT2} from three different values (2.5V, 2.8V, 3.0V), therefore providing high design flexibility. The CMOS construction of the TC1305 results to a very low supply current, which does not increase with load changes. In addition, V_{OUT} remains stable and within regulation at no load currents.

The TC1305 also features an integrated microprocessor supervisor that monitors power-up, power-down, and brown-out conditions. The active low $\overline{\text{RESET}}$ signal is asserted when the detected voltage V_{DET} falls below the reset voltage threshold (2.63V). The $\overline{\text{RESET}}$ output remains low for 300msec (typical) after V_{DET} rises above the reset threshold. The $\overline{\text{RESET}}$ output of the TC1305 is ensured valid down to $V_{DET} = 1V$ and is optimized to reject fast transient glitches on the monitored power supply line.

4.0 TYPICAL APPLICATIONS

4.1 Input and Output Capacitor

The TC1305 is stable with a wide range of capacitor values and types. A capacitor with a minimum value of $1\mu\text{F}$ from V_{OUT} to Ground is required. The output capacitor should have an effective series resistance (ESR) of 0.1Ω to 10Ω for a $1\mu\text{F}$ capacitor and 0.01Ω to 10Ω for a $10\mu\text{F}$ capacitor. A $1\mu\text{F}$ capacitor should be connected from the V_{IN} to GND if there is more than 10 inches of wire between the regulator and the AC filter capacitor, or if a battery is used as the power source. Aluminum electrolytic or tantalum capacitor types can be used. (Since many aluminum electrolytic capacitors freeze at approximately -30°C , solid tantalums are recommended for applications operating below -20°C). When operating from sources other than batteries, supply-noise rejection and transient response can be improved by increasing the value of the input and output capacitors and employing passive filtering techniques.

4.2 Bypass Capacitor

A $0.01\mu\text{F}$ capacitor connected from the bypass input to ground reduces noise present on the internal reference, which in turn significantly reduces output noise. If output noise is not a concern, this input may be left unconnected.

Larger capacitor values may be used, but result in a longer time period to rated output voltage when power is initially applied.

4.3 Shutdown Mode

Applying a logic high to each of the shutdown pins turns on the corresponding output. Each regulator enters shutdown mode when a logic low is applied in the corresponding input. During shutdown mode, the output voltage falls to zero, and regulator supply current is reduced to $0.5\mu\text{A}$ (max). If shutdown mode is not necessary, the pins should be connected to V_{IN} .

4.4 Select Mode™ Operation

The Select Mode™ operation is a tri-state input that allows the user to select V_{OUT1} and V_{OUT2} from three different values. By connecting the SELECT pin to GND, both output voltages (V_{OUT1} , V_{OUT2}) supply 2.5V. Connecting the SELECT pin to V_{IN} results in both output channels supplying a fixed 3.0V output. Last but not least, leaving the SELECT pin floating sets both voltages to 2.8V. This output voltage functionality provides high design flexibility and minimizes costs associated with inventory, time-to-market and new device qualifications.

4.5 RESET Output

The microprocessor supervisor of the TC1305 provides accurate supply voltage monitoring and reset timing during power-up, power-down and brown-out conditions. The RESET output is valid to $V_{DET} = 1.0V$ (below this point it becomes an open circuit and does not sink current) and is able to reject negative going transients (glitches) on the power supply line. Transient immunity can further be improved by adding a capacitor close to the V_{DET} pin of the TC1305.

4.6 Turn On Response

The turn on response is defined as two separate response categories, Wake Up Time (t_{WK}) and Settling Time (t_S).

The TC1305 has a fast Wake Up Time (10 μ sec typical) when released from shutdown. See Figure 4-1 for the Wake Up Time designated as t_{WK} . The Wake Up Time is defined as the time it takes for the output to rise to 2% of the V_{OUT} value after being released from shutdown.

The total turn on response is defined as the Settling Time (t_S), see Figure 4-1. Settling Time (inclusive with t_{WK}) is defined as the condition when the output is within 2% of its fully enabled value (40 μ sec typical) when released from shutdown. The settling time of the output voltage is dependent on load conditions and output capacitance on V_{OUT} (RC response).

FIGURE 4-1: WAKE-UP RESPONSE TIME

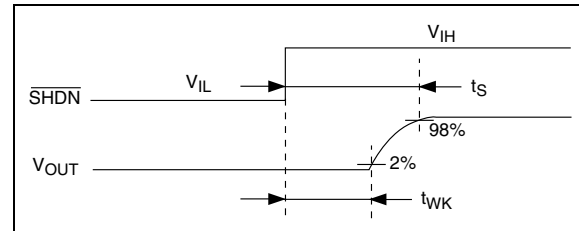

5.0 THERMAL CONSIDERATIONS

5.1 Thermal Shutdown

Integrated thermal protection circuitry shuts the regulator off when die exceeds approximately 160°C. The regulator remains off until the die temperature drops to approximately 145°C.

Thermal shutdown is intended to protect the device under transient accidental (fault) overload conditions. Thermal Shutdown may not protect the LDO while operating above junction temperatures of 125°C continuously. Sufficient thermal evaluation of the design needs to be conducted to ensure that the junction temperature does not exceed 125°C.

5.2 Power Dissipation

The amount of power the regulator dissipates is primarily a function of input and output voltage, and output current. The following equation is used to calculate worst case *actual* power dissipation.

EQUATION 5-1:

$$P_D \approx (V_{INMAX} - V_{OUT1MIN})I_{LOAD1MAX} + (V_{INMAX} - V_{OUT2MIN})I_{LOAD2MAX}$$

Where:

P_D = Worst case actual power dissipation
 V_{INMAX} = Maximum voltage on V_{IN}
 $V_{OUT1MIN}$ = Minimum regulator output voltage1
 $I_{LOAD1MAX}$ = Maximum output (load) current1
 $V_{OUT2MIN}$ = Minimum regulator output voltage2
 $I_{LOAD2MAX}$ = Maximum output (load) current2

The maximum *allowable* power dissipation (Equation 5-2) is a function of the maximum ambient temperature (T_{AMAX}), the maximum allowable die temperature (125°C), and the thermal resistance from junction-to-air (θ_{JA}). The MSOP-10 package has a θ_{JA} of approximately 113°C/W when mounted on a four layer FR4 dielectric copper clad PC board.

EQUATION 5-2:

$$P_{DMAX} = \frac{(T_{JMAX} - T_{AMAX})}{\theta_{JA}}$$

Where all terms are previously defined.

Equation 5-1 can be used in conjunction with Equation 5-2 to ensure regulator thermal operation is within limits. For example:

Given:

$$\begin{aligned} V_{INMAX} &= 3.8V \pm 5\% \\ V_{OUT1MIN} &= 3.0V \pm 2.5\% \\ V_{OUT2MIN} &= 3.0V \pm 2.5\% \\ I_{LOAD1MAX} &= 120mA \\ I_{LOAD2MAX} &= 120mA \\ T_{JMAX} &= 125^\circ C \\ T_{AMAX} &= 55^\circ C \\ \theta_{JA} &= 113^\circ C/W \end{aligned}$$

Find: 1. Actual power dissipation
 2. Maximum allowable dissipation

Actual power dissipation:

$$\begin{aligned} P_D &\approx [(V_{INMAX} - V_{OUT1MIN}) \times I_{LOAD1MAX} \\ &+ [(V_{INMAX} - V_{OUT2MIN}) \times I_{LOAD2MAX} \\ &[(3.8 \times 1.05) - (3.0 \times .975)] \times 120 \times 10^{-3} \\ &+ [(3.8 \times 1.05) - (3.0 \times .975)] \times 120 \times 10^{-3} \\ &= 256mW \end{aligned}$$

Maximum allowable power dissipation:

$$\begin{aligned} P_D &= \frac{(T_{JMAX} - T_{AMAX})}{\theta_{JA}} \\ &= \frac{(125 - 55)}{113} \\ &= 620mW \end{aligned}$$

In this example, the TC1305 dissipates a maximum of 256mW; below the allowable limit of 620mW. In a similar manner, Equation 5-1 and Equation 5-2 can be used to calculate maximum current and/or input voltage limits. For example, the maximum allowable V_{IN} is found by substituting the maximum allowable power dissipation of 620mW into Equation 5-1, from which $V_{INMAX} = 5.6V$.

5.3 Layout Considerations

The primary path of heat conduction out of the package is via the package leads. Therefore, layouts having a ground plane, wide traces at the pads, and wide power supply bus lines combine to lower θ_{JA} and therefore increase the maximum allowable power dissipation limit.

TC1305

6.0 TYPICAL CHARACTERISTICS

Note: The graphs and tables provided following this note are a statistical summary based on a limited number of samples and are provided for informational purposes only. The performance characteristics listed herein are not tested or guaranteed. In some graphs or tables, the data presented may be outside the specified operating range (e.g., outside specified power supply range) and therefore outside the warranted range.

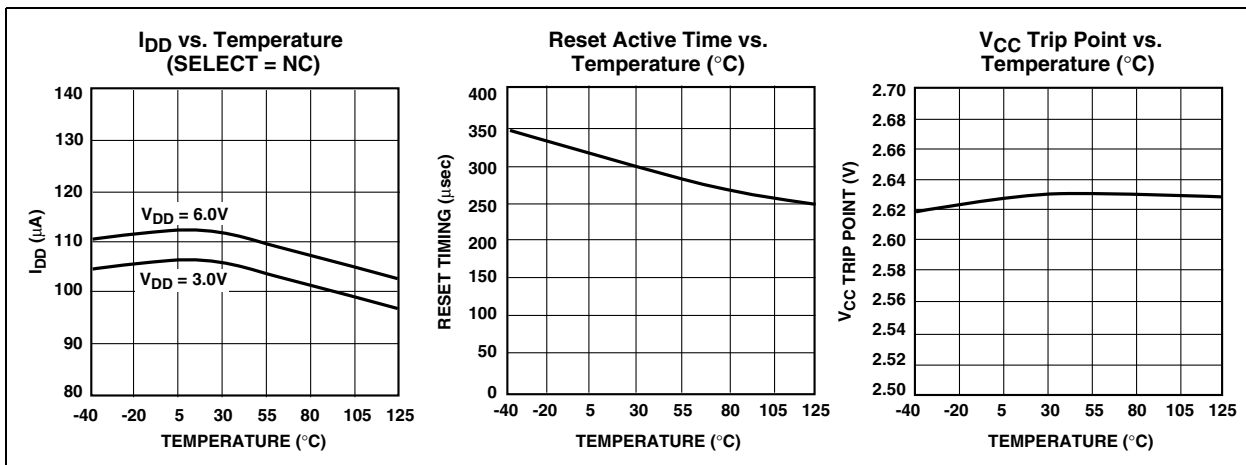
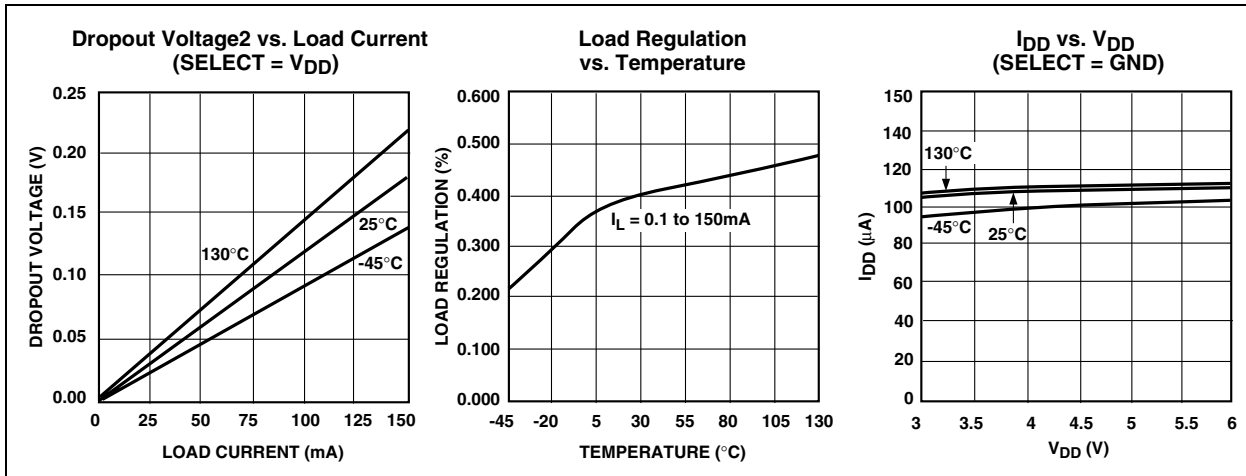
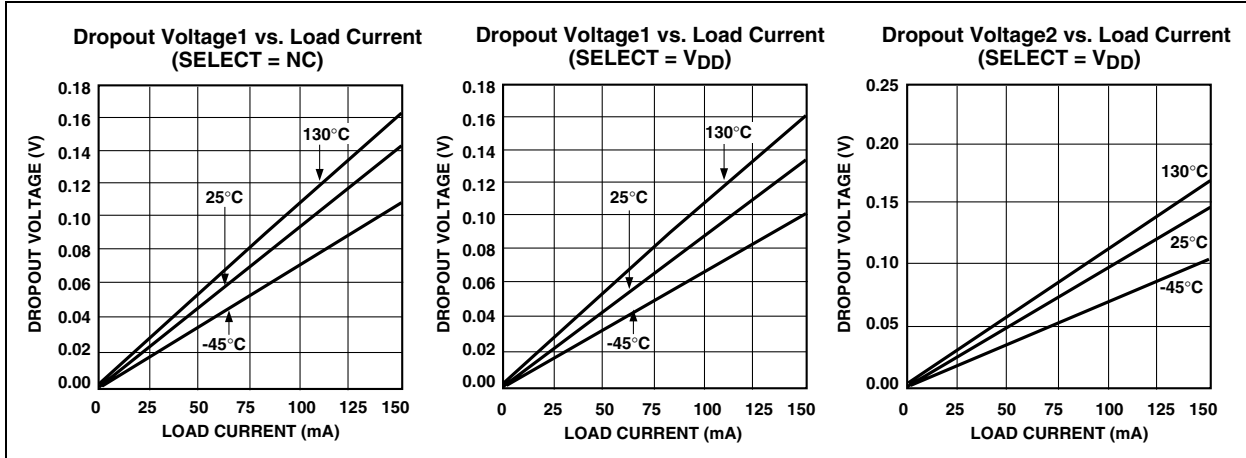

6.0 TYPICAL CHARACTERISTICS (CONTINUED)

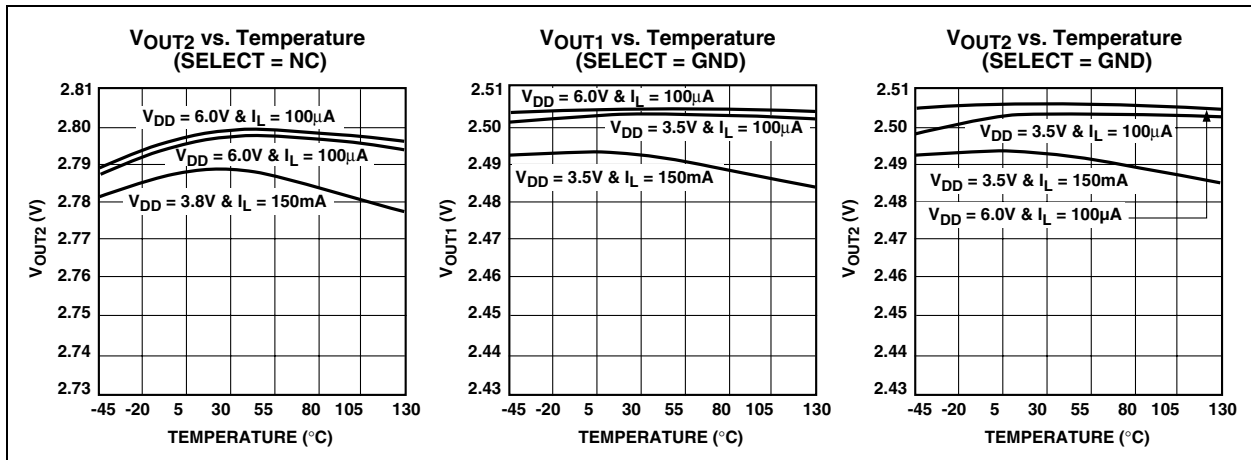
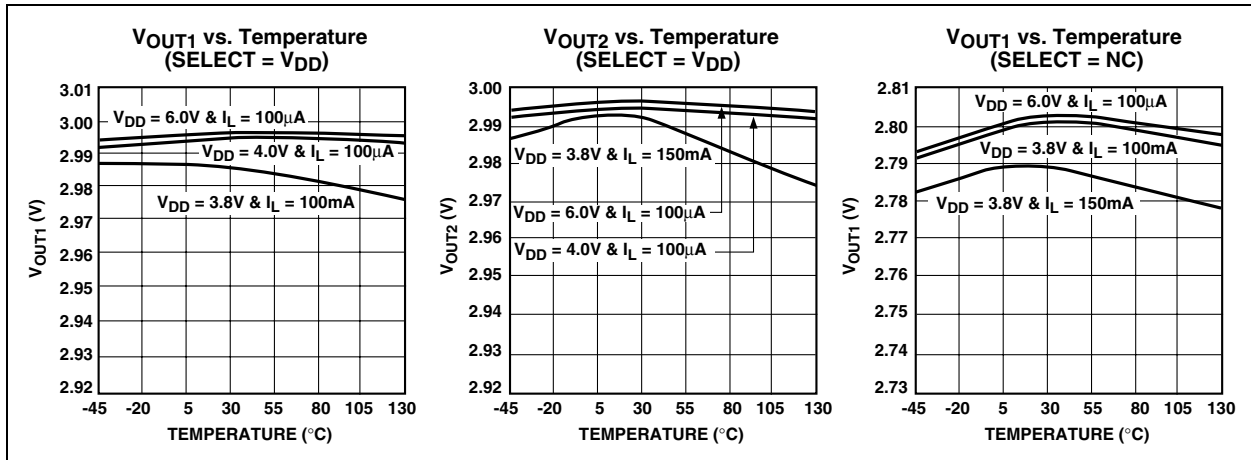

6.0 TYPICAL CHARACTERISTICS (CONTINUED)

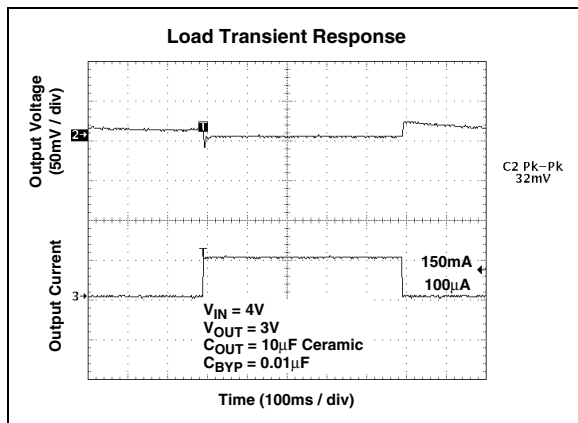
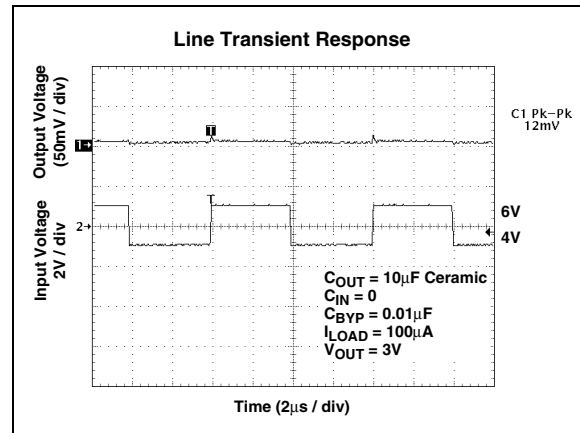
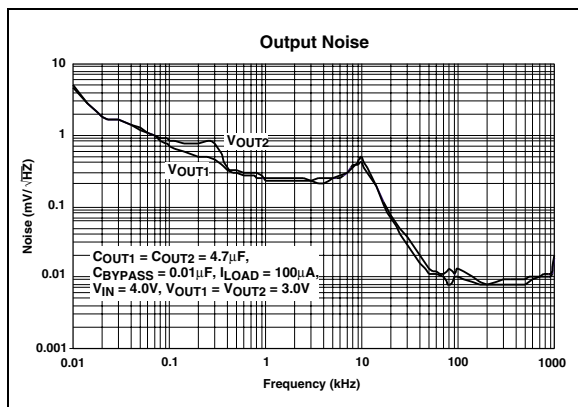
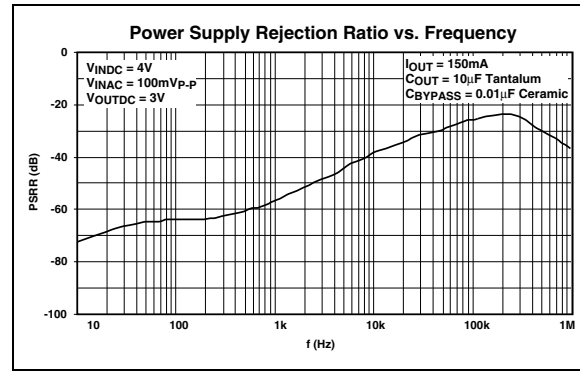
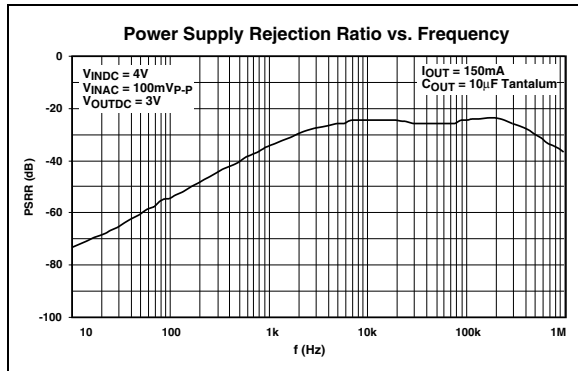

6.0 TYPICAL CHARACTERISTICS (CONTINUED)

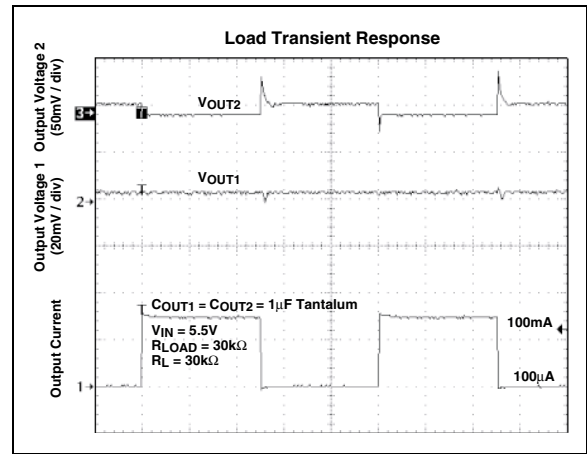
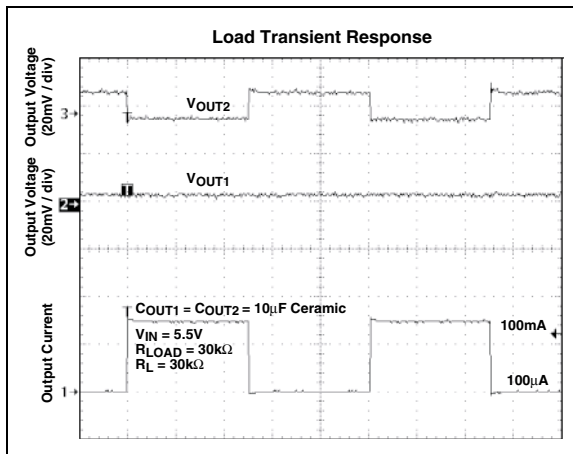
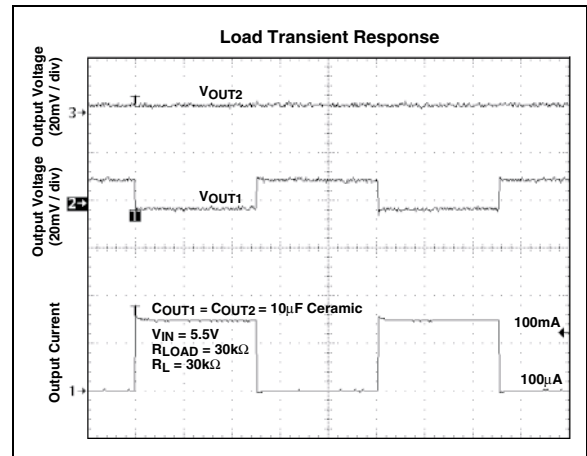
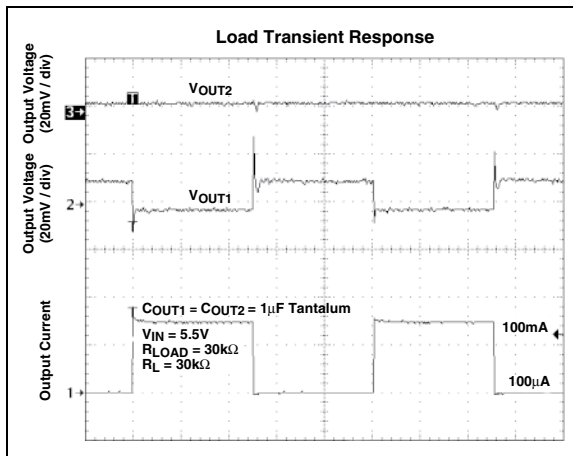
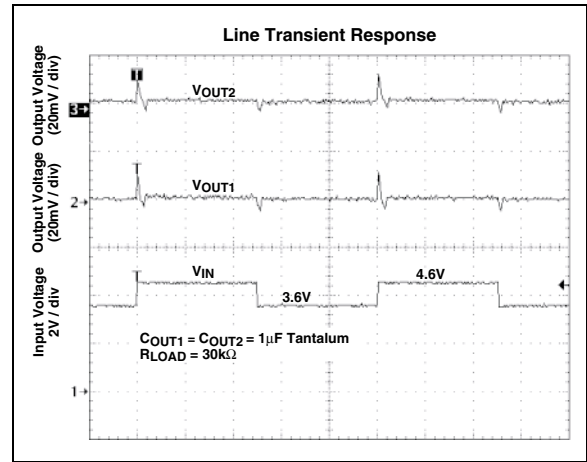
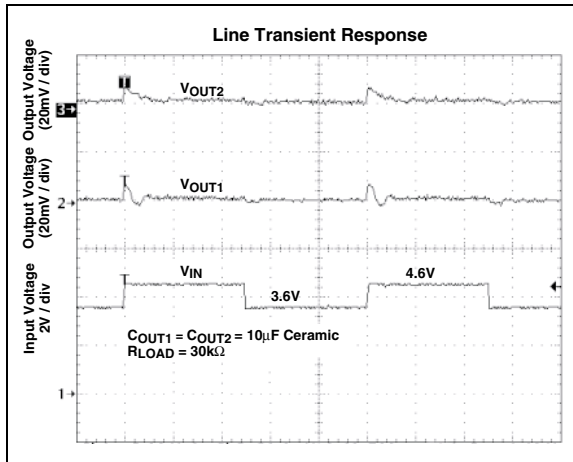

6.0 TYPICAL CHARACTERISTICS (CONTINUED)

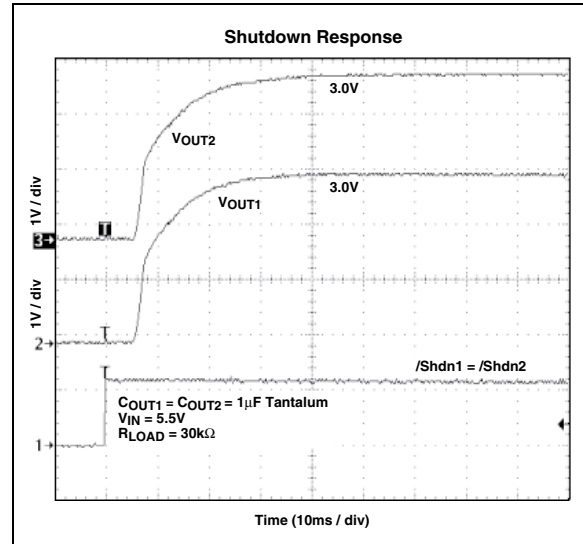
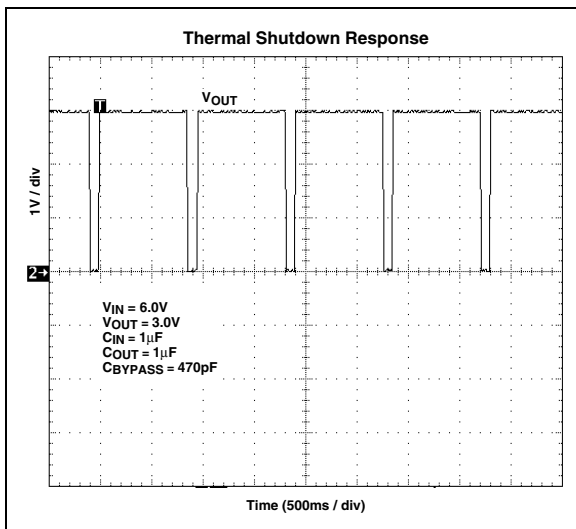
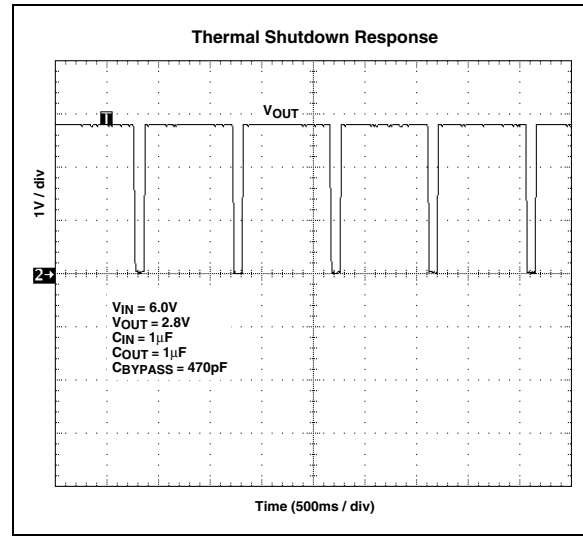
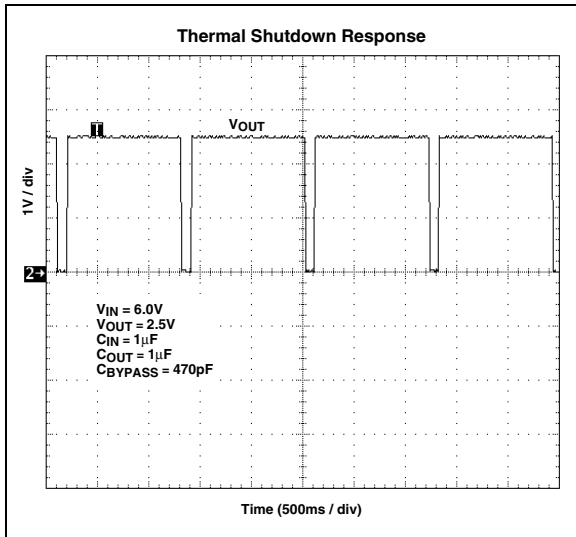

7.0 PACKAGING INFORMATION

7.1 Package Marking Information

Package marking data not available at this time.

7.2 Taping Form

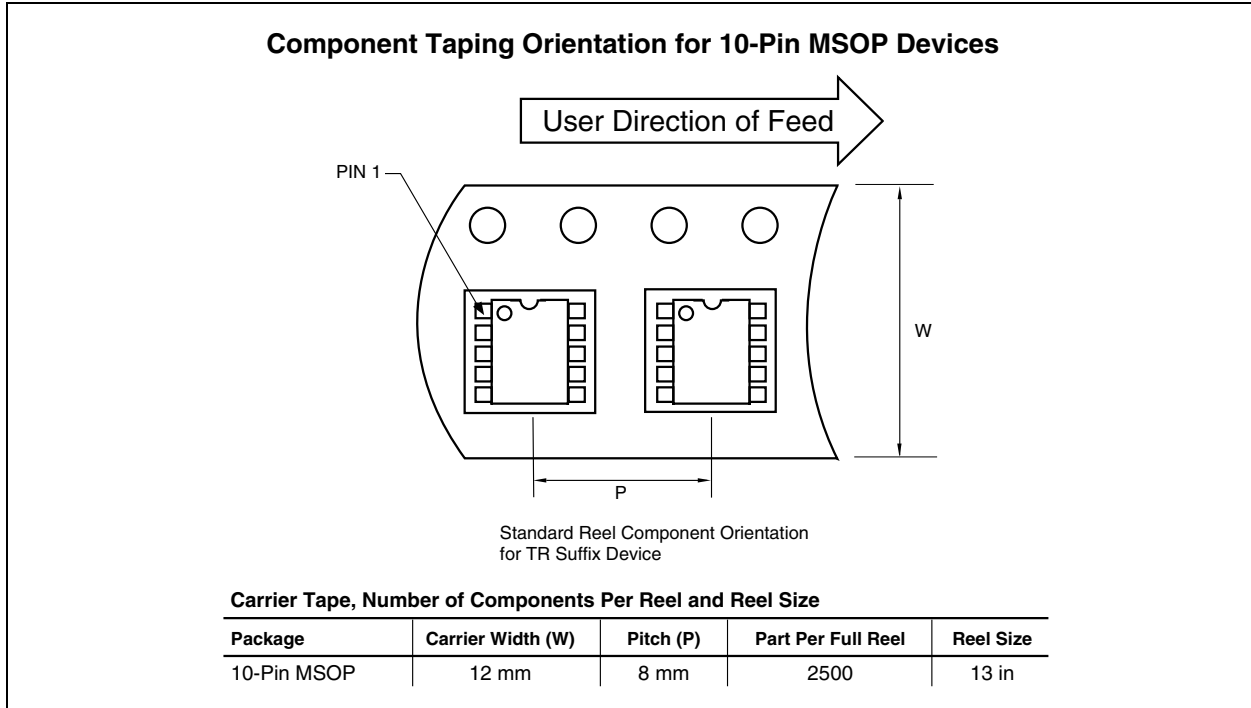

7.3 Package Dimensions

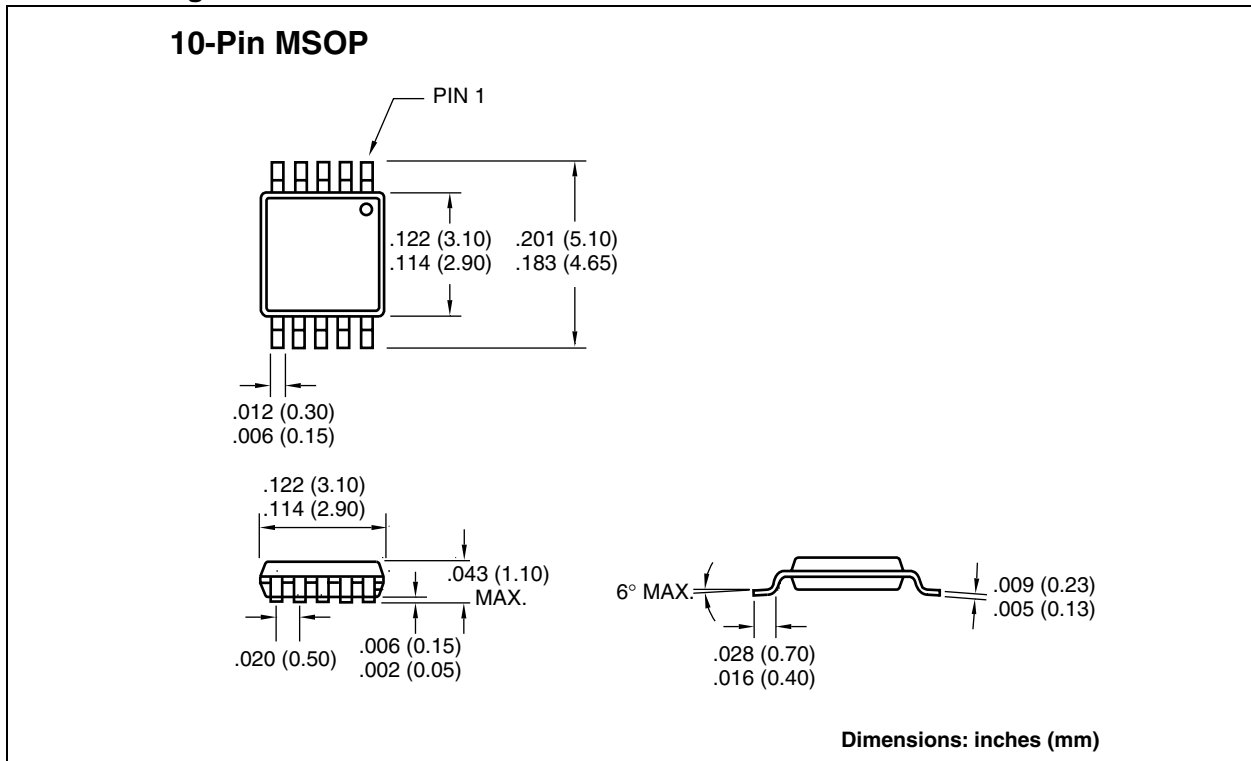

TC1305

NOTES:

Sales and Support

Data Sheets

Products supported by a preliminary Data Sheet may have an errata sheet describing minor operational differences and recommended workarounds. To determine if an errata sheet exists for a particular device, please contact one of the following:

1. Your local Microchip sales office
2. The Microchip Corporate Literature Center U.S. FAX: (480) 792-7277
3. The Microchip Worldwide Site (www.microchip.com)

Please specify which device, revision of silicon and Data Sheet (include Literature #) you are using.

New Customer Notification System

Register on our web site (www.microchip.com/cn) to receive the most current information on our products.

TC1305

NOTES:

Information contained in this publication regarding device applications and the like is intended through suggestion only and may be superseded by updates. It is your responsibility to ensure that your application meets with your specifications. No representation or warranty is given and no liability is assumed by Microchip Technology Incorporated with respect to the accuracy or use of such information, or infringement of patents or other intellectual property rights arising from such use or otherwise. Use of Microchip's products as critical components in life support systems is not authorized except with express written approval by Microchip. No licenses are conveyed, implicitly or otherwise, under any intellectual property rights.

Trademarks

The Microchip name and logo, the Microchip logo, FilterLab, KEELOQ, microID, MPLAB, PIC, PICmicro, PICMASTER, PICSTART, PRO MATE, SEEVAL and The Embedded Control Solutions Company are registered trademarks of Microchip Technology Incorporated in the U.S.A. and other countries.

dsPIC, ECONOMONITOR, FanSense, FlexROM, fuzzyLAB, In-Circuit Serial Programming, ICSP, ICEPIC, microPort, Migratable Memory, MPASM, MPLIB, MPLINK, MPSIM, MXDEV, PICC, PICDEM, PICDEM.net, rfPIC, Select Mode and Total Endurance are trademarks of Microchip Technology Incorporated in the U.S.A.

Serialized Quick Turn Programming (SQTP) is a service mark of Microchip Technology Incorporated in the U.S.A.

All other trademarks mentioned herein are property of their respective companies.

© 2002, Microchip Technology Incorporated, Printed in the U.S.A., All Rights Reserved.

 Printed on recycled paper.

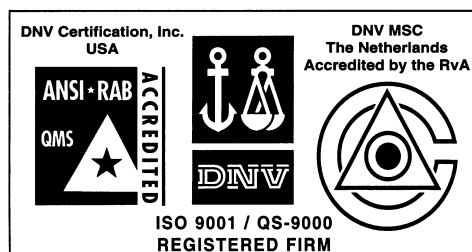

Microchip received QS-9000 quality system certification for its worldwide headquarters, design and wafer fabrication facilities in Chandler and Tempe, Arizona in July 1999 and Mountain View, California in March 2002. The Company's quality system processes and procedures are QS-9000 compliant for its PICmicro® 8-bit MCUs, KEELOQ® code hopping devices, Serial EEPROMs, microperipherals, non-volatile memory and analog products. In addition, Microchip's quality system for the design and manufacture of development systems is ISO 9001 certified.



MICROCHIP

WORLDWIDE SALES AND SERVICE

AMERICAS

Corporate Office

2355 West Chandler Blvd.
Chandler, AZ 85224-6199
Tel: 480-792-7200 Fax: 480-792-7277
Technical Support: 480-792-7627
Web Address: <http://www.microchip.com>

Rocky Mountain

2355 West Chandler Blvd.
Chandler, AZ 85224-6199
Tel: 480-792-7966 Fax: 480-792-7456

Atlanta

500 Sugar Mill Road, Suite 200B
Atlanta, GA 30350
Tel: 770-640-0034 Fax: 770-640-0307

Boston

2 Lan Drive, Suite 120
Westford, MA 01886
Tel: 978-692-3848 Fax: 978-692-3821

Chicago

333 Pierce Road, Suite 180
Itasca, IL 60143
Tel: 630-285-0071 Fax: 630-285-0075

Dallas

4570 Westgrove Drive, Suite 160
Addison, TX 75001
Tel: 972-818-7423 Fax: 972-818-2924

Detroit

Tri-Atria Office Building
32255 Northwestern Highway, Suite 190
Farmington Hills, MI 48334
Tel: 248-538-2250 Fax: 248-538-2260

Kokomo

2767 S. Albright Road
Kokomo, Indiana 46902
Tel: 765-864-8360 Fax: 765-864-8387

Los Angeles

18201 Von Karman, Suite 1090
Irvine, CA 92612
Tel: 949-263-1888 Fax: 949-263-1338

New York

150 Motor Parkway, Suite 202
Hauppauge, NY 11788
Tel: 631-273-5305 Fax: 631-273-5335

San Jose

Microchip Technology Inc.
2107 North First Street, Suite 590
San Jose, CA 95131
Tel: 408-436-7950 Fax: 408-436-7955

Toronto

6285 Northam Drive, Suite 108
Mississauga, Ontario L4V 1X5, Canada
Tel: 905-673-0699 Fax: 905-673-6509

ASIA/PACIFIC

Australia

Microchip Technology Australia Pty Ltd
Suite 22, 41 Rawson Street
Epping 2121, NSW
Australia
Tel: 61-2-9868-6733 Fax: 61-2-9868-6755

China - Beijing

Microchip Technology Consulting (Shanghai)
Co., Ltd., Beijing Liaison Office
Unit 915
Bei Hai Wan Tai Bldg.
No. 6 Chaoyangmen Beidajie
Beijing, 100027, No. China
Tel: 86-10-85282100 Fax: 86-10-85282104

China - Chengdu

Microchip Technology Consulting (Shanghai)
Co., Ltd., Chengdu Liaison Office
Rm. 2401, 24th Floor,
Ming Xing Financial Tower
No. 88 TIDU Street
Chengdu 610016, China
Tel: 86-28-6766200 Fax: 86-28-6766599

China - Fuzhou

Microchip Technology Consulting (Shanghai)
Co., Ltd., Fuzhou Liaison Office
Unit 28F, World Trade Plaza
No. 71 Wusi Road
Fuzhou 350001, China
Tel: 86-591-7503506 Fax: 86-591-7503521

China - Shanghai

Microchip Technology Consulting (Shanghai)
Co., Ltd.
Room 701, Bldg. B
Far East International Plaza
No. 317 Xian Xia Road
Shanghai, 200051
Tel: 86-21-6275-5700 Fax: 86-21-6275-5060

China - Shenzhen

Microchip Technology Consulting (Shanghai)
Co., Ltd., Shenzhen Liaison Office
Rm. 1315, 13/F, Shenzhen Kerry Centre,
Renminnan Lu
Shenzhen 518001, China
Tel: 86-755-2350361 Fax: 86-755-2366086

Hong Kong

Microchip Technology Hongkong Ltd.
Unit 901-6, Tower 2, Metroplaza
223 Hing Fong Road
Kwai Fong, N.T., Hong Kong
Tel: 852-2401-1200 Fax: 852-2401-3431

India

Microchip Technology Inc.
India Liaison Office
Divyasree Chambers
1 Floor, Wing A (A3/A4)
No. 11, O'Shaugnessey Road
Bangalore, 560 025, India
Tel: 91-80-2290061 Fax: 91-80-2290062

Japan

Microchip Technology Japan K.K.
Benex S-1 6F
3-18-20, Shinyokohama
Kohoku-Ku, Yokohama-shi
Kanagawa, 222-0033, Japan
Tel: 81-45-471-6166 Fax: 81-45-471-6122

Korea

Microchip Technology Korea
168-1, Youngbo Bldg. 3 Floor
Samsung-Dong, Kangnam-Ku
Seoul, Korea 135-882
Tel: 82-2-554-7200 Fax: 82-2-558-5934

Singapore

Microchip Technology Singapore Pte Ltd.
200 Middle Road
#07-02 Prime Centre
Singapore, 188980
Tel: 65-6334-8870 Fax: 65-6334-8850

Taiwan

Microchip Technology Taiwan
11F-3, No. 207
Tung Hua North Road
Taipei, 105, Taiwan
Tel: 886-2-2717-7175 Fax: 886-2-2545-0139

EUROPE

Denmark

Microchip Technology Nordic ApS
Regus Business Centre
Lautrup høj 1-3
Ballerup DK-2750 Denmark
Tel: 45 4420 9895 Fax: 45 4420 9910

France

Microchip Technology SARL
Parc d'Activite du Moulin de Massy
43 Rue du Saule Trapu
Batiment A - 1er Etage
91300 Massy, France
Tel: 33-1-69-53-63-20 Fax: 33-1-69-30-90-79

Germany

Microchip Technology GmbH
Gustav-Heinemann Ring 125
D-81739 Munich, Germany
Tel: 49-89-627-144 0 Fax: 49-89-627-144-44

Italy

Microchip Technology SRL
Centro Direzionale Colleoni
Palazzo Taurus 1 V. Le Colleoni 1
20041 Agrate Brianza
Milan, Italy
Tel: 39-039-65791-1 Fax: 39-039-6899883

United Kingdom

Arizona Microchip Technology Ltd.
505 Eskdale Road
Winnersh Triangle
Wokingham
Berkshire, England RG41 5TU
Tel: 44 118 921 5869 Fax: 44-118 921-5820

03/01/02

