

REVISIONS				
ZONE	REV	DESCRIPTION	DATE	APPROVED

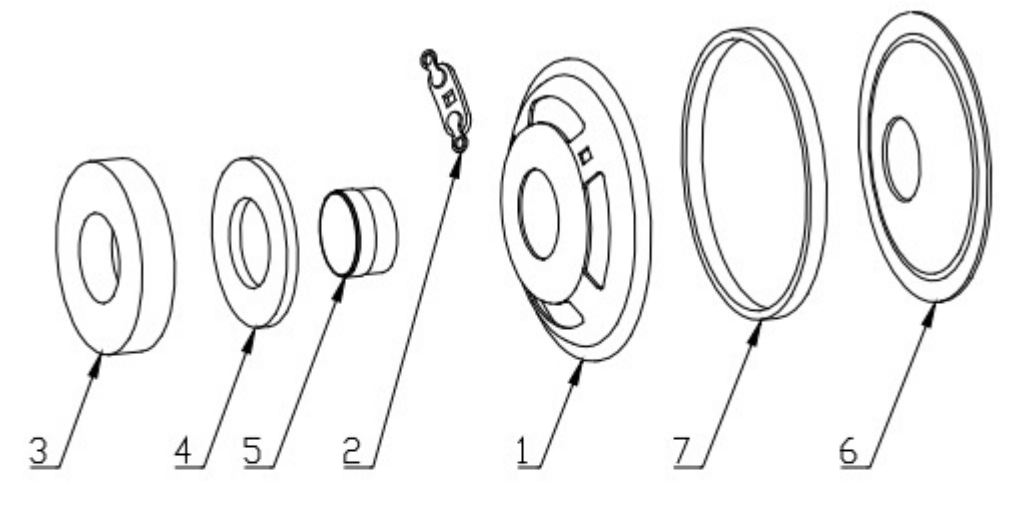

no	item	material	quantity
1	Frame	Metal	1
2	PCB Terminal	Paper+metal	1
3	Magnet	Ferrite	1
4	Plate	SPCC	1
5	Voice Coil	Paper+Cu	1
6	Diaphragm	Foam + paper	1
7	Casket	Paper	1

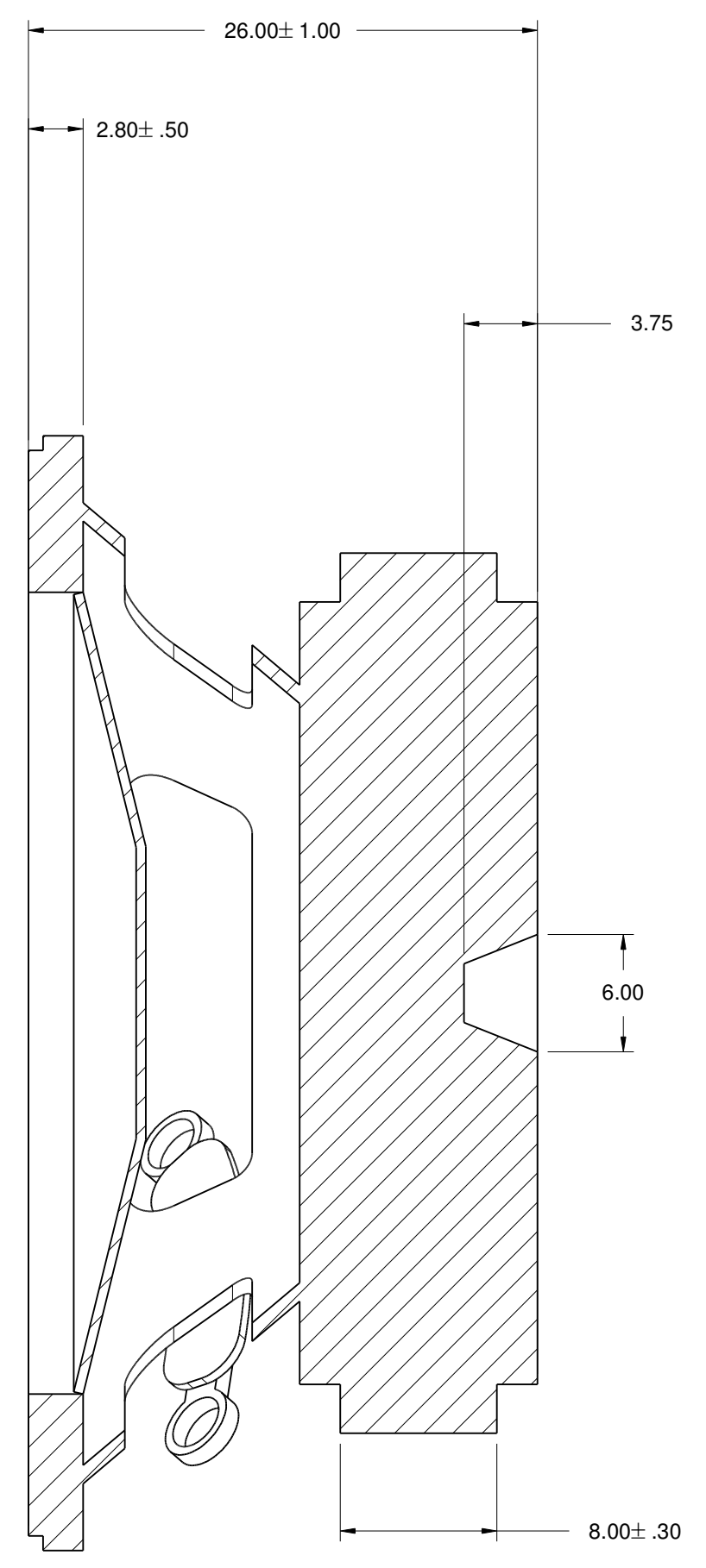
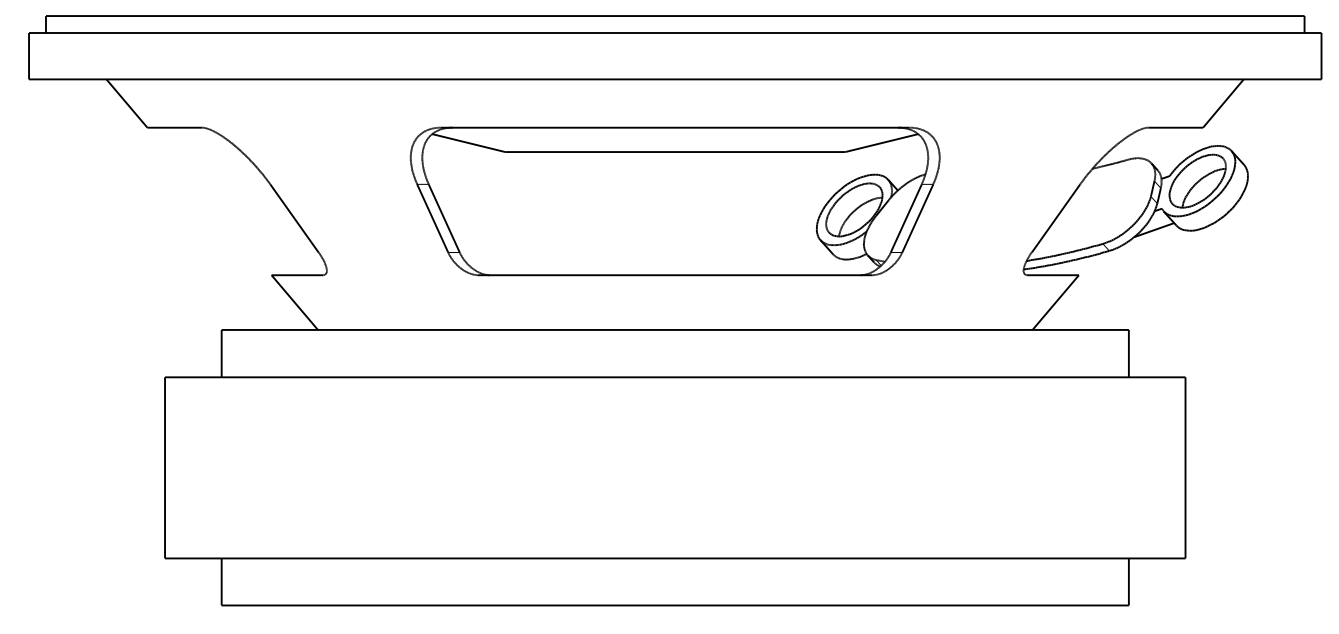

Section A-A

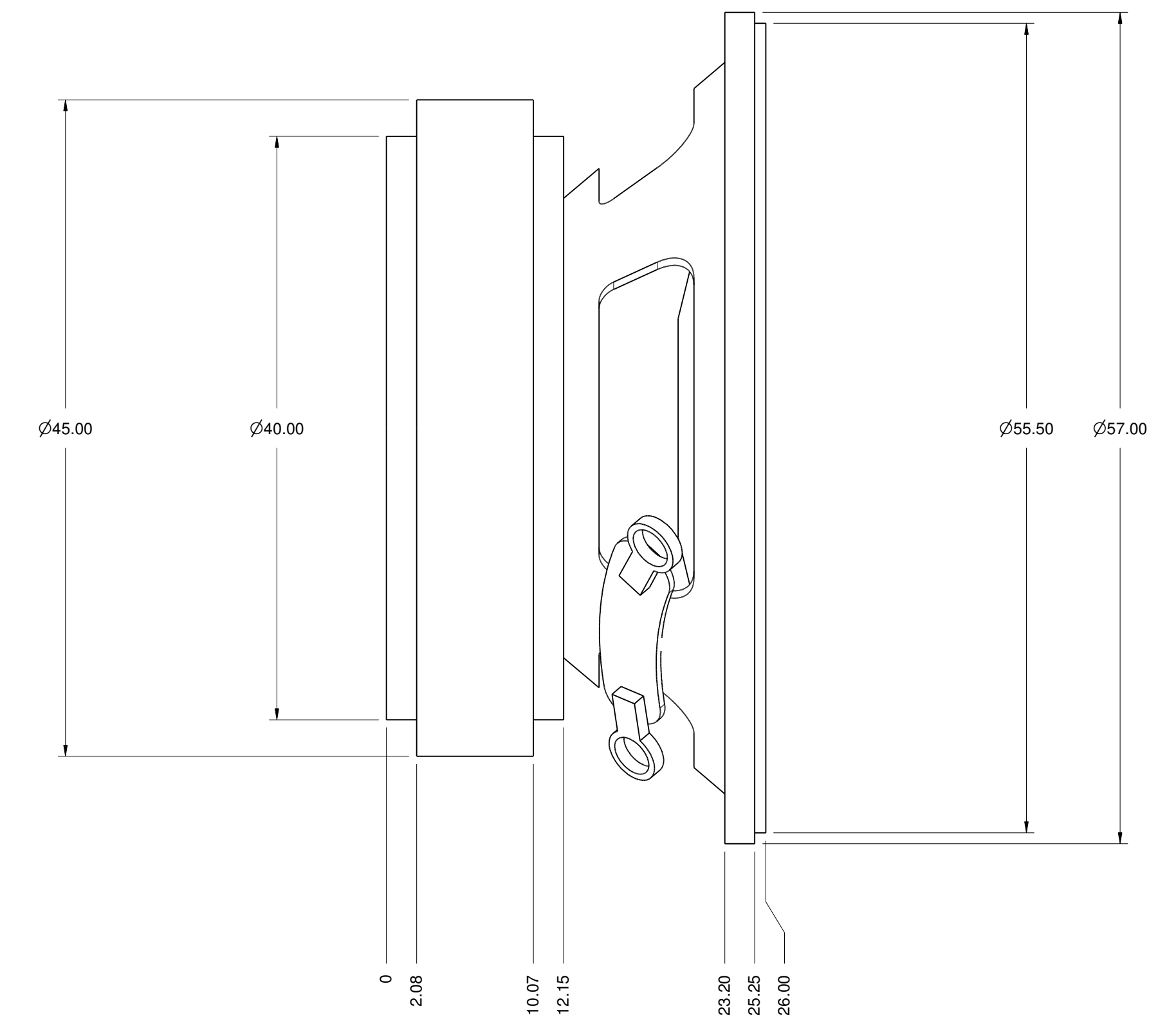
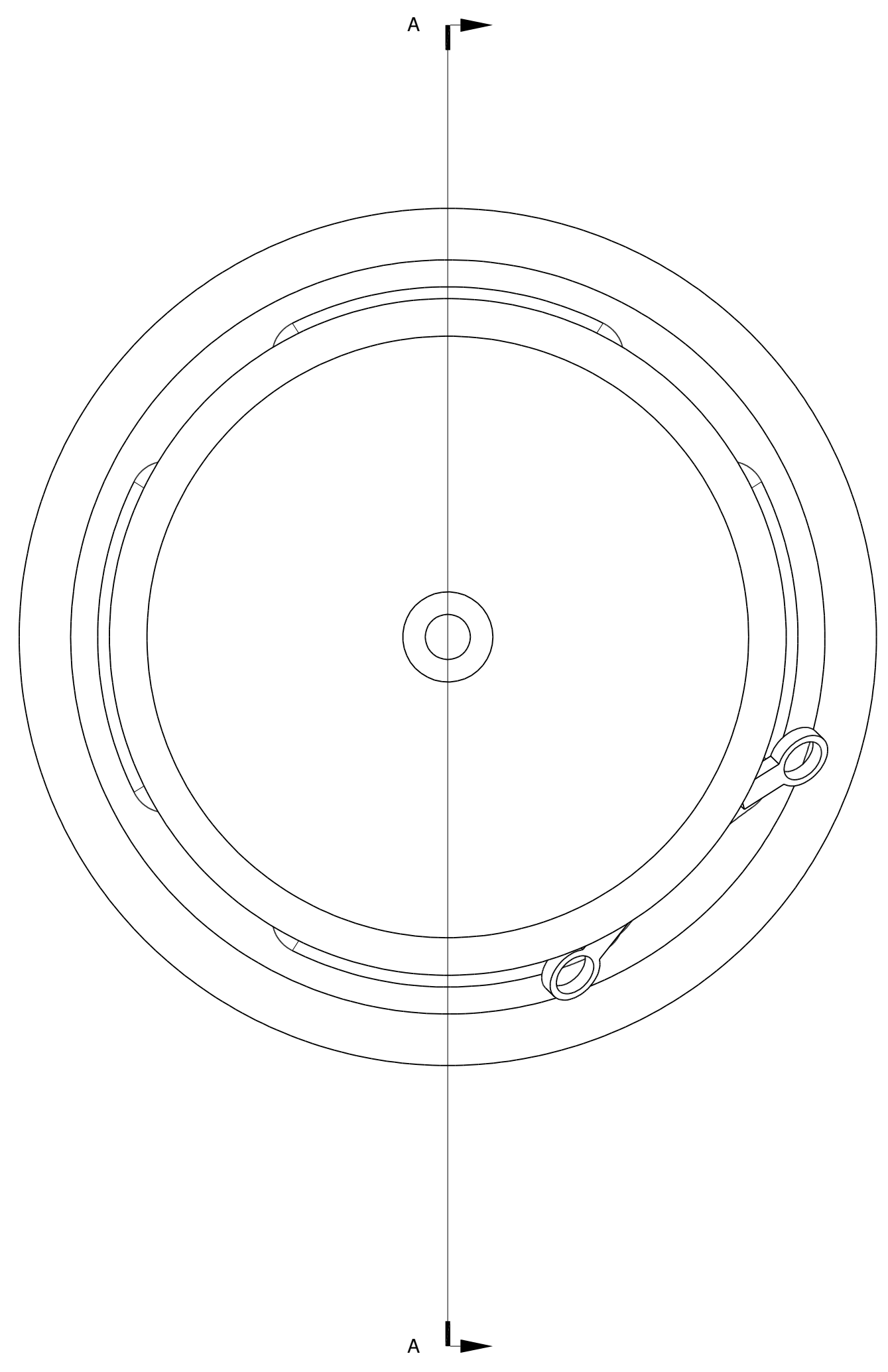

SIZE	FSCM NO.	DWG NO.	REV
D		SP-5726	
SCALE	SHEET		1 OF 1
1:1			