

Features

- 100-240VAC Input
- Primary side regulated
- EI-30 transformer pinout
- Full load operation: -25 to 55°C
- No load power consumption <100mW
- Household and ITE certified

Regulated Converter



RAC05E-KT

5 Watt



1.07"x1.26"

Single Output

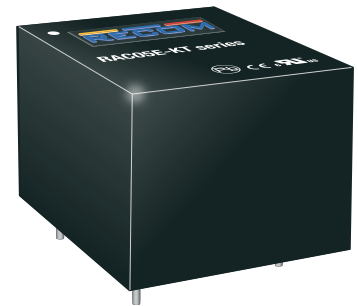

UL/IEC/EN62368-1 certified
 CAN/CSA C22.2 No. 62368-1 certified
 IEC/EN60335-1 certified
 EN62233 certified
 IEC/EN61558-1 certified
 IEC/EN61558-2-16 certified
 EN55032/EN55035 compliant
 EN IEC 61204-3 compliant
 CB Report

Description

The economically priced RAC05E-KT series of primary side regulated AC/DC converters is designed to meet general purpose requirements for ITE and office use as well as household applications or light industrial automation processes, with less than 0.1W no load power consumption. The footprint is based on the common industry standard pinning for EI30 transformers and AC/DC modules such as the RAC05-K/277 Series for enhanced performance. The RAC05E-KT modules hold UL and CB certifications to IEC 62368-1 standard and to EN 60335-1 for household applications. Certified for full load operation from -25°C to +55°C and worldwide input voltage ranges of nominal 100-240VAC, the modules feature a semi regulated output with permanent short circuit and over voltage protection. Without external components the series meets EN 55014, EN 55032 class B and FCC15 limits for worldwide electromagnetic compatibility.

Selection Guide

Part Number	Input Voltage Range [VAC]	Output Voltage [VDC]	Output Current [mA]	Efficiency typ. (1) [%]
RAC05E-04SKT	90-264	4	1250	72
RAC05E-05SKT	90-264	5	1000	74
RAC05E-12SKT	90-264	12	417	78
RAC05E-15SKT	90-264	15	333	79
RAC05E-24SKT	90-264	24	208	80

Notes:

Note1: Efficiency is tested at nominal input and full load at +25°C ambient

Model Numbering



Ordering Examples:

RAC05E-04SKT 5 Watt 4Vout
 RAC05E-24SKT 5 Watt 24Vout

Specifications (measured @ Ta= 25°C, nom. Vin= 230VAC, full load and after warm-up unless otherwise stated)

BASIC CHARACTERISTICS					
Parameter	Condition		Min.	Typ.	Max.
Internal Input Filter					Pi type
Nominal Input Voltage	50/60Hz		100VAC		240VAC
Operating Range ^(2,3)	47-63Hz		90VAC	230VAC	264VAC
	DC		130VDC		
Input Current	115VAC				250mA
	230VAC				100mA
Inrush Current	cold start at 25°C	115VAC			20A
		230VAC			10A
No load Power Consumption					100mW
Input Frequency Range	AC Input		47Hz		63Hz
ErP Standby Mode Conformity (Output Load Capability)	Input power= 0.5W				0.32
	1.0W				0.68
Minimum Load			0%		
Power Factor	115VAC		0.55		
	230VAC		0.45		
Start-up Time				20ms	
Rise Time				15ms	
Hold-up Time	115VAC		8ms		
	230VAC		20ms		
Internal Operating Frequency	100% load at nominal Vin				130kHz
Output Ripple and Noise ⁽⁴⁾	20MHz BW	4Vout & 5Vout			70mVp-p
		others			1% of Vout

Notes:

- Note2: The products were submitted for safety files at AC-Input operation
- Note3: Refer to **“Line Derating”**
- Note4: Measurements are made with a 0.1µF MLCC & 10µF E-cap in parallel across output. (low ESR)

Efficiency vs. Load

RAC05E-04SKT + RAC05E-05SKT

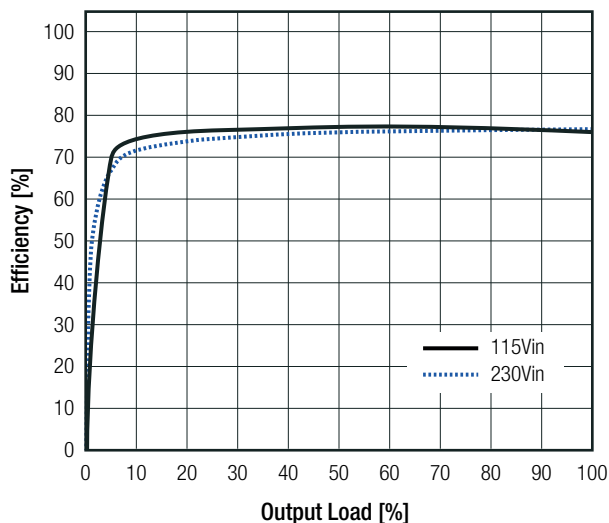

RAC05E-12SKT + RAC05E-15SKT

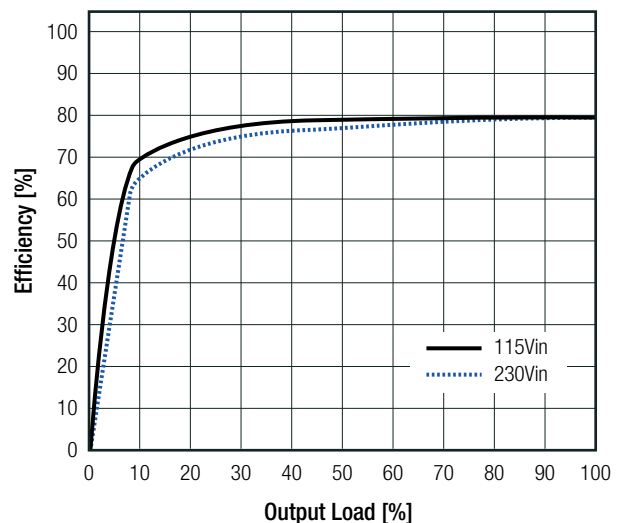

continued on next page

Specifications (measured @ Ta= 25°C, nom. Vin= 230VAC, full load and after warm-up unless otherwise stated)

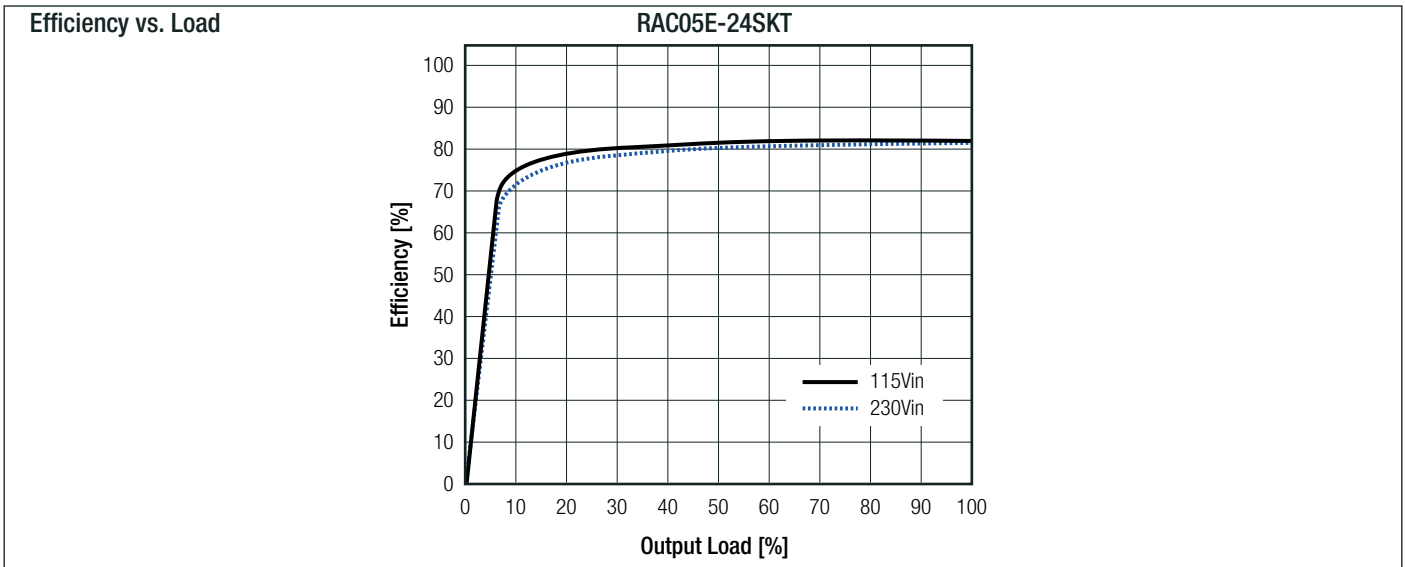

REGULATIONS

Parameter	Condition	Value
Output Accuracy		±3.0% typ.
Line Regulation		±2.0% typ.
Load Regulation ⁽⁵⁾		2.0% typ.

Notes:

Note5: Operation below 10% load will not harm the converter, but specifications may not be met

Deviation vs. Load

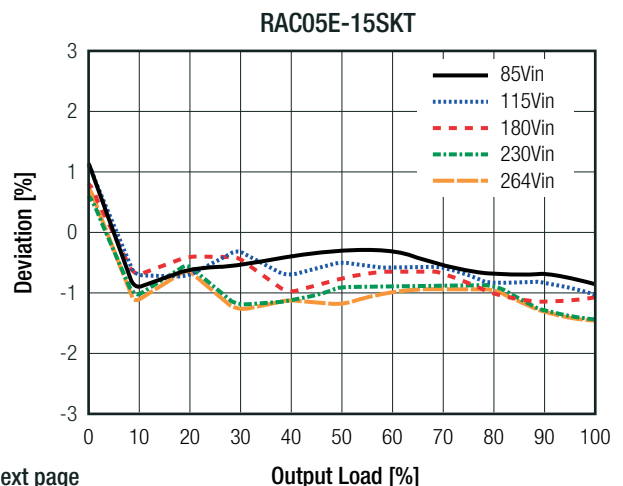
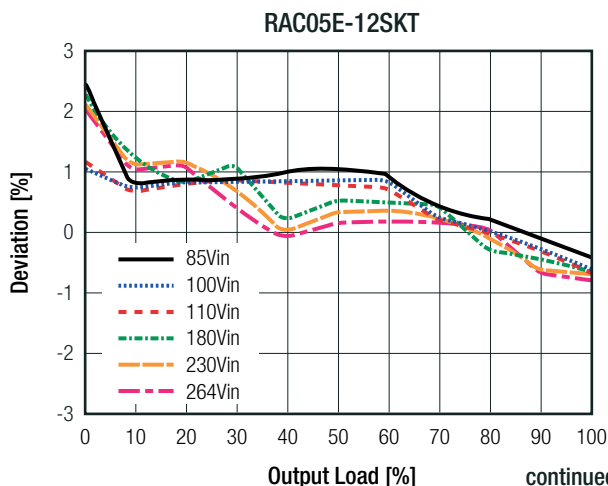
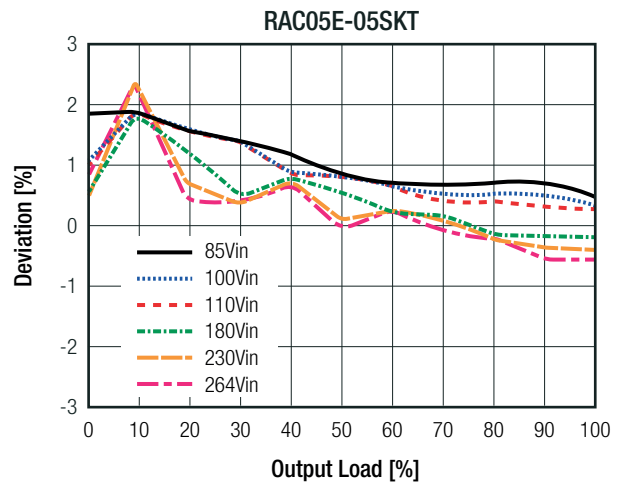
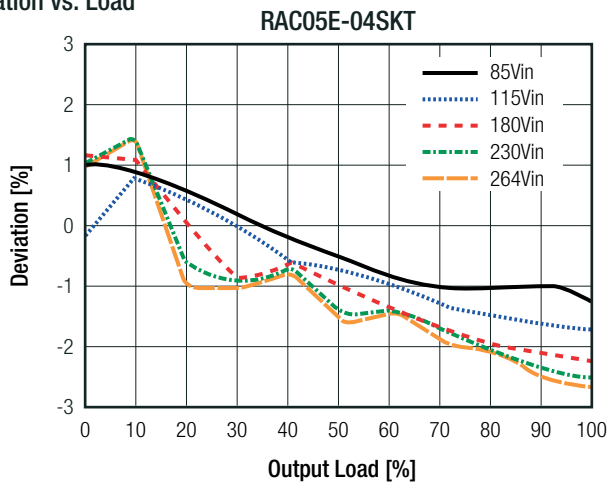

continued on next page

Specifications (measured @ Ta= 25°C, nom. Vin= 230VAC, full load and after warm-up unless otherwise stated)

Deviation vs. Load

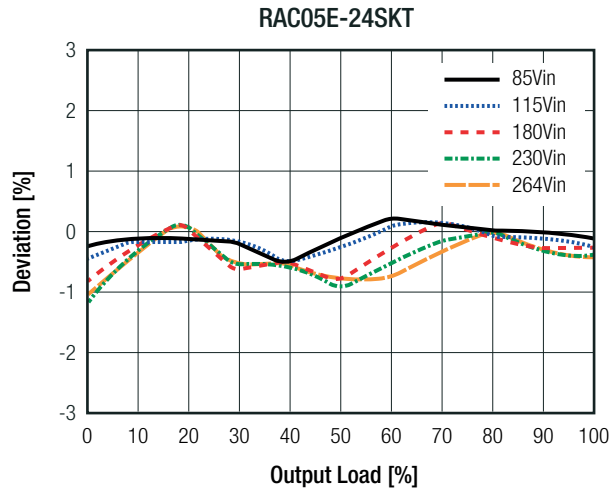

PROTECTIONS

Parameter	Type			Value
Input Fuse	internal			fusible resistor 5.1Ω
Short Circuit Protection (SCP)	below 100mΩ			Hiccup mode, auto recovery
Over Voltage Category (OVC)				OVCII
Over Current Protection (OCP)				120% - 180%, hiccup mode
Isolation Voltage (safety certified)	I/P to O/P	1 minute	according to 60335-1 according to 62368-1 according to 61558	3kVAC 2877Vrms 4.2kVAC
Insulation Grade				reinforced

ENVIRONMENTAL

Parameter	Condition		Value
Operating Temperature Range	full load refer to <i>"Derating Graph"</i>		-25°C to +75°C
Maximum Case Temperature			+90°C
Temperature Coefficient			±0.05%/K
Operating Altitude			5000m
Operating Humidity	non-condensing		20% - 95% RH max.
Pollution Degree			PD2
Vibration			10-500Hz, 2G10min./1cycle, period 60min. each along x,y,z axes
MTBF	according to MIL-HDBK-217F, G.B.	+25°C +40°C	2250 x 10 ³ hours 2140 x 10 ³ hours
Design Lifetime	230VAC/60Hz and full load	+50°C	>40 x 10 ³ hours

continued on next page

Specifications (measured @ Ta= 25°C, nom. Vin= 230VAC, full load and after warm-up unless otherwise stated)

Derating Graph

(@ Chamber and natural convection 0.1m/s)

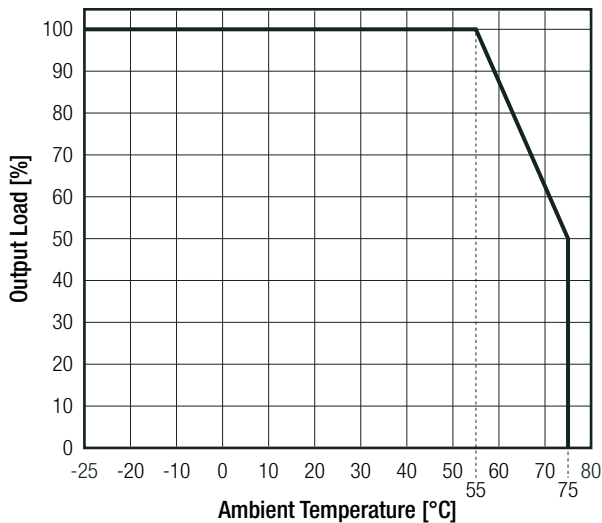

Line Derating

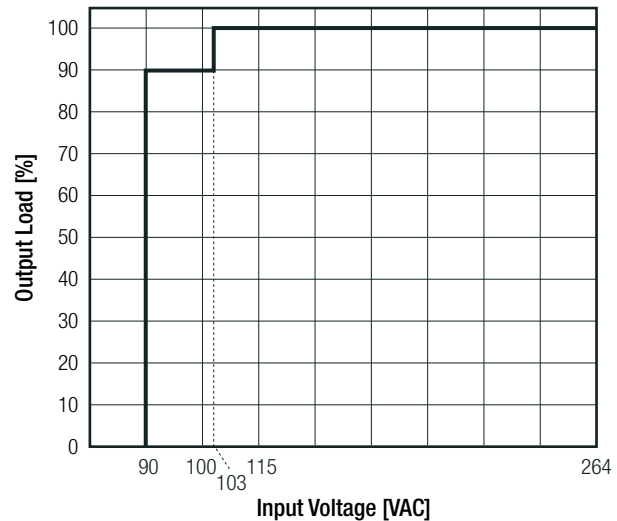

SAFETY AND CERTIFICATIONS

Certificate Type (Safety)	Report Number	Standard
Audio/Video, information and communication technology equipment - Part 1: Safety requirements	E518942-A6003-UL	UL62368-1:2014 CAN/CSA-C22.2 No. 62368-1:2014
Audio/Video, information and communication technology equipment - Safety requirements (CB Scheme)	E518942-A6003-CB-1	IEC62368-1:2014 2nd Edition
Audio/Video, information and communication technology equipment - Safety requirements (LVD)		EN62368-1:2014 + A11:2017
Household and similar electrical appliances – Safety – Part 1: General requirements (CB Scheme)	LCS200820072AS	IEC60335-1:2010 5th Edition + C1:2016
Household and similar electrical appliances – Safety – Part 1: General requirements (LVD)		EN60335-1:2012 + A11:2014+A13:2017+A1:2019+A2:2019+A14:2019
Measurement methods for electromagnetic fields of household appliances and similar apparatus with regard to human exposure		EN62233:2008
Safety of power transformers, power supplies, reactors and similar products for supply voltages up to 1100 V (CB Scheme)	NN20TGSJ-001	IEC61558-1:2005 2nd Edition + A1:2009
Safety of power transformers, power supplies, reactors & similar products for supply voltages up to 1100 V Part 2: Particular requirements (CB Scheme)		IEC61558-2-16:2009 1st Edition + A1:2013
Safety of power transformers, power supplies, reactors and similar products for supply voltages up to 1100 V	NN20UK56-001	EN61558-1:2005 + A1:2009
Safety of power transformers, power supplies, reactors & similar products for supply voltages up to 1100 V Part 2: Particular requirements		EN61558-2-16:2009 + A1:2013
RoHS2		RoHS 2011/65/EU + AM2015/863

EMC Compliance (Industrial)

EMC Compliance (Industrial)	Condition	Standard / Criterion
Electromagnetic compatibility of multimedia equipment - Emission requirements		EN55032:2015, Class A/B
Electromagnetic compatibility of multimedia equipment – Immunity requirements		EN55035:2017
ESD Electrostatic Discharge Immunity Test	Air: ± 2, 4, 8kV Contact: ±2, 4kV	IEC61000-4-2:2008, Criteria B EN61000-4-2:2009, Criteria B
Radiated, Radio-Frequency, Electromagnetic Field Immunity Test	3V/m: 80-1000MHz 1800MHz, 2600MHz 3500MHz, 5000MHz	IEC/EN61000-4-3:2006+A2:2010, Criteria A

continued on next page

Specifications (measured @ Ta= 25°C, nom. Vin= 230VAC, full load and after warm-up unless otherwise stated)

EMC Compliance (Industrial)	Condition		Standard / Criterion
Fast Transient and Burst Immunity	AC Port: ±1kV		IEC/EN61000-4-4:2012, Criteria B
Surge Immunity	AC Power Port: ±1kV		IEC61000-4-5:2014, Criteria B EN61000-4-5:2014+A1:2017, Criteria B
Immunity to Conducted Disturbances, Induced by Radio-Frequency Fields	3Vrms: 0.15-10MHz 3-1Vrms: 10-30MHz 1Vrms: 30-80MHz		IEC61000-4-6:2013, Criteria A EN61000-4-6:2014+AC:2015, Criteria A
Power Magnetic Field Immunity	1A/m		IEC61000-4-8:2009, Criteria A EN61000-4-8:2010, Criteria A
Voltage Dips and Interruption	Voltage Dips:	100%	IEC61000-4-11:2004, Criteria B EN61000-4-11:2004+A1:2017, Criteria B
		30%	IEC61000-4-11:2004, Criteria C EN61000-4-11:2004+A1:2017, Criteria C
	Interruptions:	100%	IEC61000-4-11:2004, Criteria C EN61000-4-11:2004+A1:2017, Criteria C
EMC Compliance (Low Voltage PSU)	Condition		Standard / Criterion
Low voltage power supplies, d.c. output Part 3: Electromagnetic compatibility (EMC)			EN IEC 61204-3:2018, Class A/B
ESD Electrostatic Discharge Immunity Test	Air: ± 2, 4, 8kV Contact: ±2, 4kV		IEC61000-4-2:2008, Criteria B EN61000-4-2:2009, Criteria B
Radiated, Radio-Frequency, Electromagnetic Field Immunity Test	10V/m: 80-1000MHz 3V/m: 1400-2000MHz 1V/m: 2000-2700MHz		IEC/EN61000-4-3:2006+A2:2010, Criteria A
Fast Transient and Burst Immunity	AC Port: ±2kV		IEC/EN61000-4-4:2012, Criteria B
Surge Immunity	AC Power Port: ±1kV		IEC61000-4-5:2014, Criteria B EN61000-4-5:2014+A1:2017, Criteria B
Immunity to Conducted Disturbances, Induced by Radio-Frequency Fields	10Vrms: 0.15-80MHz		IEC61000-4-6:2013, Criteria A EN61000-4-6:2014+AC:2015, Criteria A
Power Magnetic Field Immunity	30A/m		IEC61000-4-8:2009, Criteria A EN61000-4-8:2010, Criteria A
Voltage Dips and Interruption	Voltage Dips:	100% (0.5P; 1.0P)	IEC61000-4-11:2004, Criteria B EN61000-4-11:2004+A1:2017, Criteria B
		20%, 30%, 60%	IEC61000-4-11:2004, Criteria C EN61000-4-11:2004+A1:2017, Criteria C
	Interruptions:	100%	IEC61000-4-11:2004, Criteria C EN61000-4-11:2004+A1:2017, Criteria C
Limits of Voltage Fluctuations & Flicker			EN61000-3-3:2013+A1:2019
Limitations on the amount of electromagnetic interference allowed from digital and electronic devices			FCC 47 CFR Part 15 Subpart B, Class B
Limitations on the amount of electromagnetic interference allowed from digital and electronic devices, industrial, scientific, and medical equipment			FCC 47 CFR Part 18

DIMENSION AND PHYSICAL CHARACTERISTICS

Parameter	Type	Value
Material	case/baseplate potting PCB	black plastic, (UL94 V-0) PU, (UL94 V-0) FR4, (UL94 V-0)
Dimension (LxWxH)		27.1 x 32.1 x 21.8.0mm
Weight		26.4g typ.

continued on next page

Specifications (measured @ Ta= 25°C, nom. Vin= 230VAC, full load and after warm-up unless otherwise stated)

Dimension Drawing (mm)

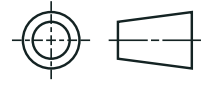
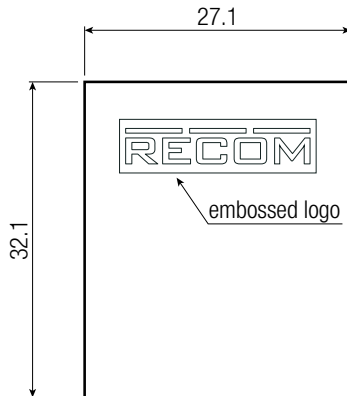

General tolerances according to ISO 2768-m (table for reference only)	
Dimension range	Tolerances
0.5 - 6 mm	±0.1 mm
6 - 30 mm	±0.2 mm
30 - 120 mm	±0.3 mm
120 - 400 mm	±0.5 mm

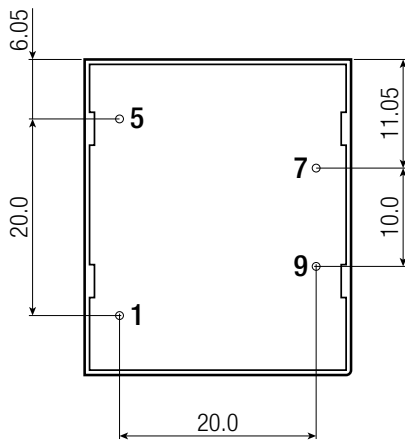
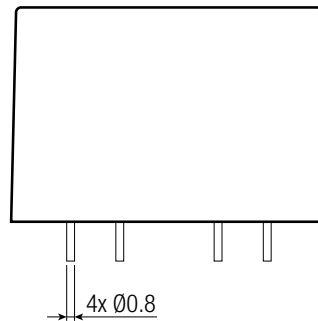
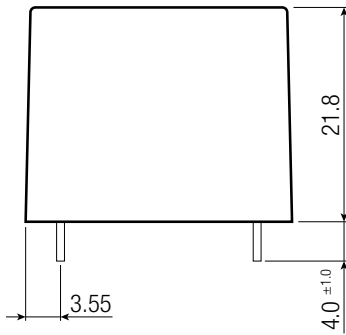

Recommended Footprint Details

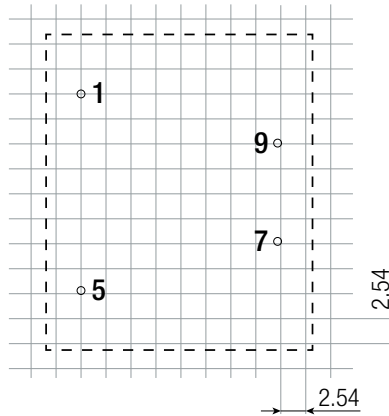

Pinning Information

Pin #	Single
1	VAC in (N)
5	VAC in (L)
7	+Vout
9	-Vout

PACKAGING INFORMATION

Parameter	Type	Value
Packaging Dimension (LxWxH)	tube	466.0 x 29.3 x 30.4mm
Packaging Quantity		12pcs

The product information and specifications may be subject to changes even without prior written notice. The product has been designed for various applications; its suitability lies in the responsibility of each customer. The products are not authorized for use in safety-critical applications without RECOM's explicit written consent. A safety-critical application is an application where a failure may reasonably be expected to endanger or cause loss of life, inflict bodily harm or damage property. The applicant shall indemnify and hold harmless RECOM, its affiliated companies and its representatives against any damage claims in connection with the unauthorized use of RECOM products in such safety-critical applications.