

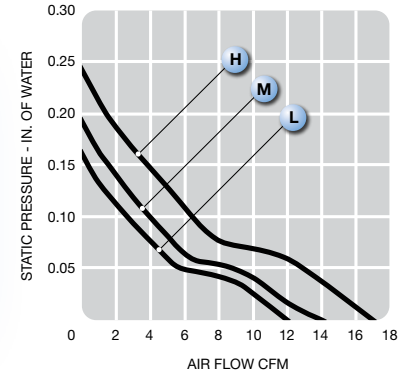

LPH60B99 series

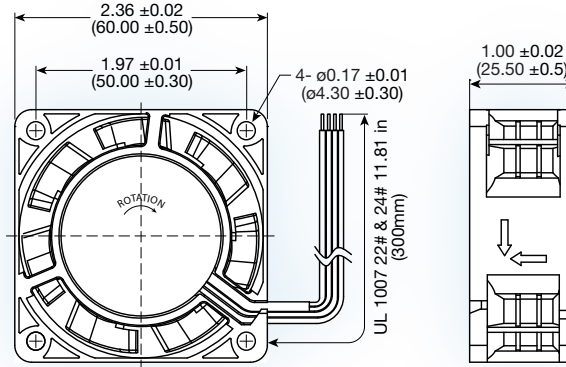

(60 x 60 x 25 mm)

2.36 x 2.36 x 1.00 inches

Operating voltage: 85 to 265 VAC

Construction: plastic frame and impeller

Bearing option: ball bearing

Motor: electronically commutated

Air flow: exhaust over struts

Connection: lead wire UL1007 24AWG
or terminal

Protection/IP Level: auto restart / IP54

Options: tachometer, PWM,
environmental protection

Model No.	Rated Voltage V	Freq. HZ	Input Power W	Rated Cur. A	Speed RPM	Air Volume		Max. Static Pressure (H ₂ O)		Sound Noise dB(A)	Weight g
						M ³ /Min.	CFM	MM	INCH		
LPH60B99-L*	100-240	50/60	1.4	0.04	3500	0.34	12	4.1	0.16	31	69
LPH60B99-M*	100-240	50/60	1.7	0.05	4000	0.36	13	4.8	0.19	33	69
LPH60B99-H	100-240	50/60	2.3	0.06	4500	0.48	17	6.1	0.24	35	69

*This speed not UL recognized