



TiM581-2050101

TiM5xx

2D LIDAR SENSORS

SICK
Sensor Intelligence.



Ordering information

| Type | Part no. |
|----------------|----------|
| TiM581-2050101 | 1099504 |

Other models and accessories → www.sick.com/TiM5xx



Detailed technical data

Features

| | |
|------------------------------|---------------------------------------|
| Measurement principle | HDDM ⁺ |
| Application | Outdoor |
| Light source | Infrared (850 nm) |
| Laser class | 1 (IEC 60825-1:2014, EN 60825-1:2014) |
| Aperture angle | Horizontal 270° |
| Scanning frequency | 15 Hz |
| Angular resolution | 0.33° |
| Working range | 0.05 m ... 25 m |
| Scanning range | At 10% remission 8 m |

Mechanics/electronics

| | |
|-------------------------------|--|
| Connection type | 1 x "Ethernet" connection, 4-pin M12 female connector 1 x connection "Power/Synchronization output" 5-pin, M12 male connector 1 x Micro USB female connector, type B |
| Supply voltage | 9 V DC ... 28 V DC |
| Power consumption | Typ. 4 W |
| Housing color | Gray (RAL 7032) |
| Enclosure rating | IP67, applies only when the plastic cover of the "Aux interface" is closed (IEC 60529:1989+AMD1:1999+AMD2:2013) |
| Protection class | III (IEC 61140:2016-1) |
| Weight | 250 g, without connecting cables |
| Dimensions (L x W x H) | 60 mm x 60 mm x 86 mm |

Performance

| | |
|----------------------|--------------------|
| Response time | 1 scan, typ. 67 ms |
|----------------------|--------------------|

¹⁾ At +45° to +225° of the working range; max. 150 ms at -45° to +45° of the working range.

²⁾ Typical value at 90% remission up to maximum scanning range; real value depends on ambient conditions.

| | |
|--------------------------------|------------------------------------|
| | 2 scans, $\leq 134 \text{ s}^{1)}$ |
| Detectable object shape | Almost any |
| Systematic error | $\pm 60 \text{ mm}^{2)}$ |
| Statistical error | $< 20 \text{ mm}^{2)}$ |
| Integrated application | Output of measurement data |

¹⁾ At $+45^\circ$ to $+225^\circ$ of the working range; max. 150 ms at -45° to $+45^\circ$ of the working range.

²⁾ Typical value at 90% remission up to maximum scanning range; real value depends on ambient conditions.

Interfaces

| | |
|---------------------------|--------------------------------|
| Ethernet | ✓, TCP/IP |
| USB | ✓ |
| Remark | Micro USB |
| Function | AUX, parameterization |
| Digital inputs | 0 |
| Digital outputs | 1 (PNP, "SYNC"/"device ready") |
| Optical indicators | 2 LEDs (ON, "device ready") |

Ambient data

| | |
|--|---|
| Object remission | 4 % ... 1,000 % (reflectors) |
| Electromagnetic compatibility (EMC) | |
| Emitted radiation | Residential area (EN 61000-6-3:2007+AMD:A1:2011) |
| Electromagnetic immunity | Industrial environment (EN 61000-6-2:2005) |
| Vibration resistance | |
| Sine resonance scan | 10 Hz ... 1,000 Hz ¹⁾ |
| Sine test | 10 Hz ... 500 Hz, 5 g, 10 frequency cycles ¹⁾ |
| Noise test | 10 Hz ... 250 Hz, 4.24 g RMS, 5 h ²⁾ |
| Shock resistance | 50 g, 11 ms, ± 3 single shocks/axis ³⁾ 25 g, 6 ms, $\pm 1,000$ continuous shocks/axis ³⁾ 50 g, 3 ms, $\pm 5,000$ continuous shocks/axis ³⁾ |
| Ambient operating temperature | $-25^\circ \text{C} \dots +50^\circ \text{C}^{4)}$ |
| Storage temperature | $-40^\circ \text{C} \dots +75^\circ \text{C}^{4)}$ |
| Temperature change | $-25^\circ \text{C} \dots +50^\circ \text{C}$, 10 cycles ⁵⁾ |
| Damp heat | $+25^\circ \text{C} \dots +55^\circ \text{C}$, 95 % rF, 6 cycles ⁶⁾ |
| Permissible relative humidity | |
| Operation | $< 80 \%$, Non-condensing (EN 60068-2-30:2005) |
| Storage | $\leq 95 \%$, Non-condensing (EN 60068-2-30:2005) |
| Ambient light immunity | 80,000 lx |

¹⁾ IEC 60068-2-6:2007.

²⁾ IEC 60068-2-64:2008.

³⁾ IEC 60068-2-27:2008.

⁴⁾ IEC 60068-2-14:2009.

⁵⁾ EN 60068-2-14:2009.

⁶⁾ EN 60068-2-30:2005.

General notes

| | |
|--------------------|---|
| Note on use | The sensor does not constitute a safety component as defined by relevant legislation on machine safety. |
|--------------------|---|

Classifications

| | |
|-----------------------|----------|
| ECl@ss 5.0 | 27270990 |
| ECl@ss 5.1.4 | 27270990 |
| ECl@ss 6.0 | 27270913 |
| ECl@ss 6.2 | 27270913 |
| ECl@ss 7.0 | 27270913 |
| ECl@ss 8.0 | 27270913 |
| ECl@ss 8.1 | 27270913 |
| ECl@ss 9.0 | 27270913 |
| ECl@ss 10.0 | 27270913 |
| ECl@ss 11.0 | 27270913 |
| ETIM 5.0 | EC002550 |
| ETIM 6.0 | EC002550 |
| ETIM 7.0 | EC002550 |
| ETIM 8.0 | EC002550 |
| UNSPSC 16.0901 | 46171620 |

Dimensional drawing (Dimensions in mm (inch))

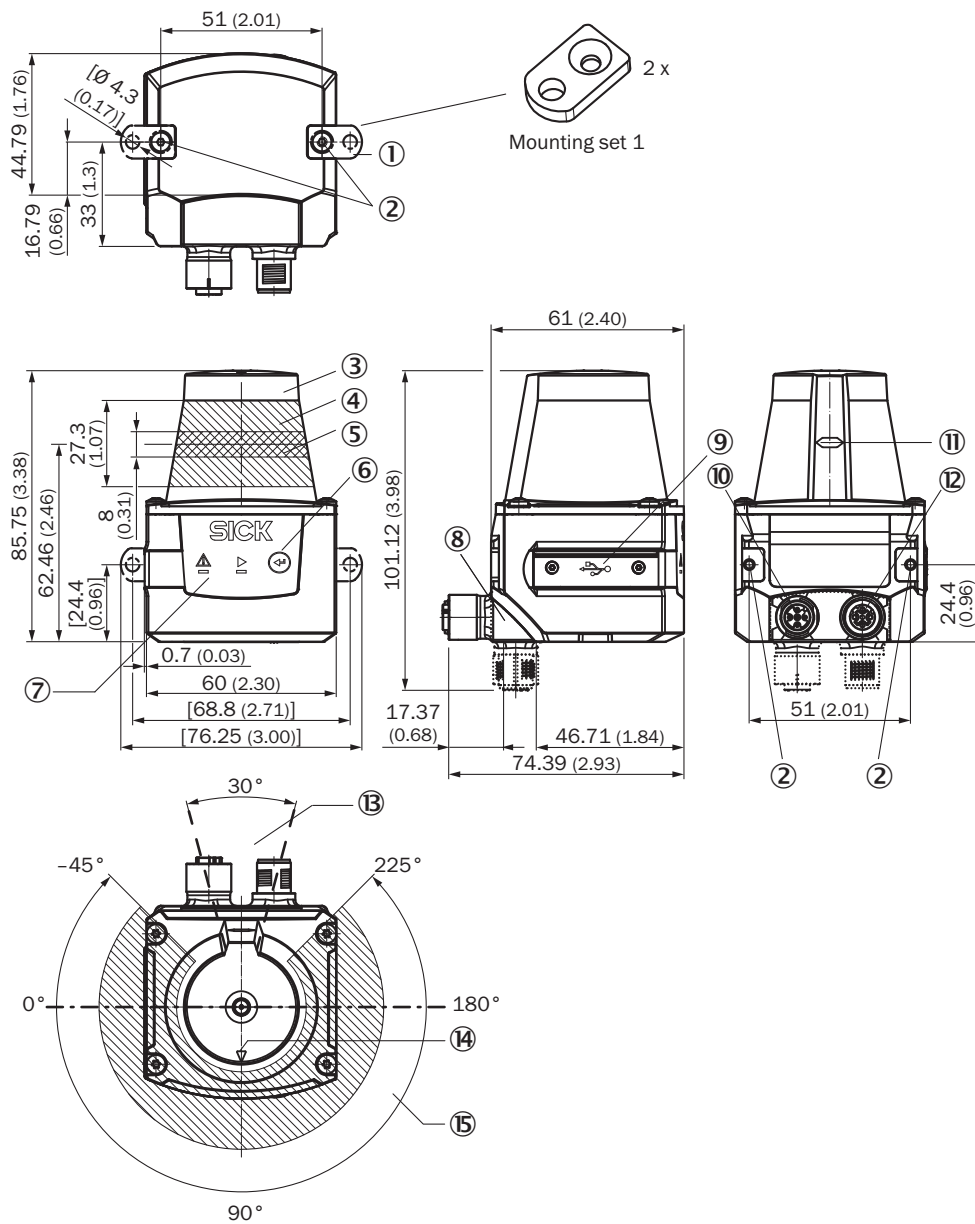

- ① 2 x straight plates with M3 x 4 mm screw (included in delivery)
- ② M3 threaded mounting hole, 2.8 mm deep (blind hole thread), max. tightening torque 0.8 Nm
- ③ Optical hood
- ④ Receiving range (light inlet)
- ⑤ Transmission range (light emission)
- ⑥ Push-button (no function)
- ⑦ Red and green LED (status displays)
- ⑧ Swivel connector unit
- ⑨ Micro USB female connector, type B
- ⑩ Connection "Power/Synchronization output" 5-pin, M12 male connector
- ⑪ Marking for the position of the light emission level
- ⑫ "Ethernet" connection, 4-pin M12 female connector
- ⑬ Area in which no reflective surfaces are allowed for mounted devices
- ⑭ Bearing marking to support alignment (90° axis)
- ⑮ Aperture angle 270° (scanning angle)

Working range diagram

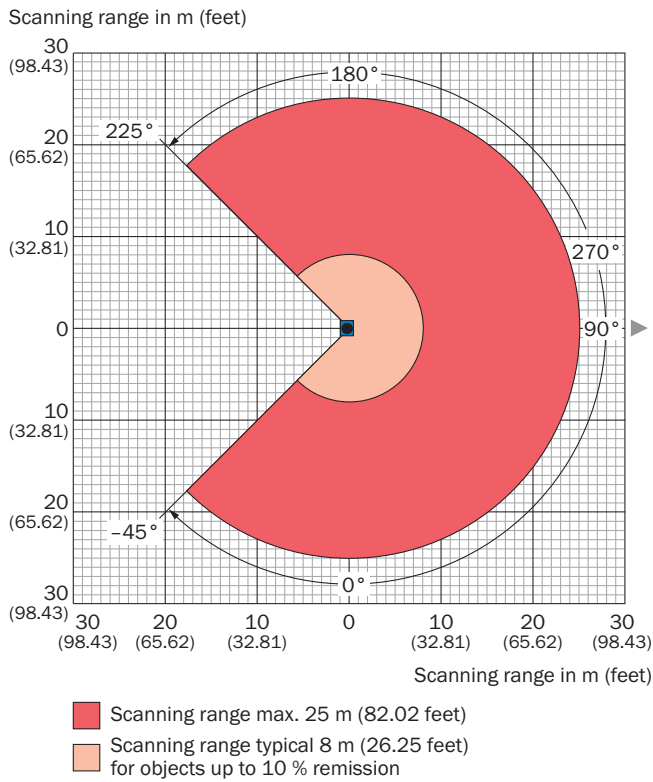

Connection type

Ethernet

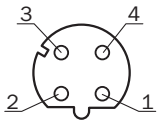

M12 female connector, 4-pin, D-coded

- ① TX+
- ② RX+
- ③ TX-
- ④ RX-

PIN assignment

Power

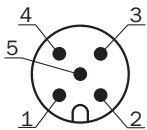





Connector M12, 5-pin, A-coded

- ① DC 9 V ... 28 V
- ② "SYNC"/"device ready"
- ③ GND
- ④ nc
- ⑤ nc

Recommended accessories

Other models and accessories → www.sick.com/TiM5xx

| | Brief description | Type | Part no. |
|--|--|--------------------|----------|
| Mounting brackets and plates | | | |
|  | Mounting kit with shock absorber, Anodized aluminum, mounting hardware included | Mounting kit | 2086074 |
| Plug connectors and cables | | | |
|  | Head A: female connector, M12, 5-pin, straight, A-coded Head B: Flying leads Cable: Power, PUR, halogen-free, shielded, 5 m | YF2A64-050XXXXLEAX | 6036159 |
|  | Head A: male connector, USB-A Head B: male connector, Micro-B Cable: USB 2.0, unshielded, 2 m | USB cable | 6036106 |
|  | Head A: male connector, M12, 4-pin, straight, D-coded Head B: male connector, RJ45, 8-pin, straight Cable: Ethernet, shielded, 5 m | YM2D24-050EB2MRJA4 | 6050200 |

Recommended services

Additional services → www.sick.com/TiM5xx

| | Type | Part no. |
|---|--|----------|
| Product, system, and software training | | |
| <ul style="list-style-type: none"> • Range of services: The training contents relate to the following 2D and 3D LiDAR sensors: LMS series, MRS1000, MRS6000, NAV series or TiM series, Training format and location can be worked out in collaboration with SICK | Training LMS/MRS/NAV/TiM | 1612234 |
| Commissioning | | |
| <ul style="list-style-type: none"> • Product area: 2D LiDAR sensors, 3D LiDAR sensors • Range of services: Inspection of connection, fine adjustment, configuration of monitored areas, configuration and optimization of parameters of the LMS/MRS/NAV/TiM as well as tests, Setup of previously defined functions of basic settings, parameters of field application, filters for raw data output and product-specific configuration • Travel expenses: The prices do not include travel costs such as hotel, flight, travel time and expenses. • Duration: Additional work will be invoiced separately | Commissioning LMS/MRS/NAV/TiM/People Counter (Prime package) | 1680672 |

| | Type | Part no. |
|--|---|----------|
| Maintenance | | |
| <ul style="list-style-type: none"> • Product area: 2D LiDAR sensors, 3D LiDAR sensors • Range of services: Inspection, analysis and restoring of defined functions, Inspection and adaptation of basic settings, parameters of field application, filters for raw data output, and product-specific configuration • Travel expenses: The prices do not include travel costs such as hotel, flight, travel time and expenses. • Duration: Additional work will be invoiced separately | Maintenance LMS/ MRS/NAV/TiM | 1682593 |
| Warranty extensions | | |
| <ul style="list-style-type: none"> • Product area: Identification solutions, machine vision, Distance sensors, Detection and ranging solutions • Range of services: The services correspond to the scope of the statutory manufacturer warranty (SICK general terms and conditions of purchase) • Duration: Five-year warranty from delivery date. | Extended warranty for a total of five years from delivery date | 1680671 |

SICK AT A GLANCE

SICK is one of the leading manufacturers of intelligent sensors and sensor solutions for industrial applications. A unique range of products and services creates the perfect basis for controlling processes securely and efficiently, protecting individuals from accidents and preventing damage to the environment.

We have extensive experience in a wide range of industries and understand their processes and requirements. With intelligent sensors, we can deliver exactly what our customers need. In application centers in Europe, Asia and North America, system solutions are tested and optimized in accordance with customer specifications. All this makes us a reliable supplier and development partner.

Comprehensive services complete our offering: SICK LifeTime Services provide support throughout the machine life cycle and ensure safety and productivity.

For us, that is “Sensor Intelligence.”

WORLDWIDE PRESENCE:

Contacts and other locations –www.sick.com