

TABLE 2		
POS	"A"	"B"
-030	.839 [21.31]	.793 [20.13]
-060	1.627 [41.31]	1.580 [40.13]
-090	2.417 [61.38]	2.368 [60.13]
-120	3.204 [81.38]	3.155 [80.14]
-150	3.991 [101.37]	3.943 [100.14]

TABLE 1	
No OF POS	COPLANARITY INCLUDING GROUND PLANE
-030 THRU -060	.004 [0.10]
-090 THRU -150	.006 [0.15]

QSH-XXX-01-X-D-XXX

**No. OF POSITIONS**  
 -030, -060, -090,  
 \*-120, \*-150 (PER ROW)  
 (\* = SEE NOTE 11)

**LEAD STYLE**  
 -01: .1280[3.25]

**PLATING SPECIFICATION**  
 (SEE NOTES 8, 10 & 12)  
 -S: 30µ" SELECTIVE GOLD IN CONTACT AREA, MATTE TIN ON TAIL (USE C126-21-S/T-1G2-01-L)  
 -F: 3µ" FLASH SELECTIVE IN CONTACT AREA, MATTE TIN ON TAIL (USE C126-21-F/T-1G2-01-F) (SEE NOTE 8)  
 -L: 10µ" LIGHT SELECTIVE GOLD IN CONTACT AREA, MATTE TIN ON TAIL (USE C126-21-L/T-1G2-01-L)  
 -H: 30µ" HEAVY GOLD IN CONTACT AREA, 3µ" GOLD ON TAIL (USE C126-21-H/T-1G2-01-G)  
 -C: 50µ" ELECTRO-POLISHED SELECTIVE GOLD IN CONTACT AREA, MATTE TIN ON TAIL (USE C126-21-C/T-1G2-01-L)

**OPTION**  
 -A: ALIGNMENT PINS (USE QSH-30-01-D-XX-A) (NOT AVAILABLE WITH -LC)  
 -LC: LOCKING CLIPS (USE LC-08-TM-01, SEE FIG 2, SHT 2) (NOT AVAILABLE WITH -A) (SEE NOTE 13)  
 -GP: GUIDE POSTS (USE QSH-30-01-D-XX-X-GP) (SEE FIG 4, SHT 3) (TAPE & REEL FOR -GP, -060 POS MAX)  
 -K: POLYIMIDE FILM PAD (USE K-DOT-.325-.450-.005, SEE FIG 3, SHT 2)  
 -TR: TAPE & REEL (-090 POS MAX) (SEE NOTE 16)  
 -FR: FULL REEL QTY. TAPE & REEL (-090 POS MAX) (SEE NOTE 17)  
 -FL: FRICTION LOCKS (SEE FIG 5, SHT 3) (NOT AVAILABLE WITH -GP)  
 -RT1: RETENTION (MUST USE -A OPTION) (USE QSH-30-01-D-XX-A-RT1 & SUB-SC-05-01-FF, SEE FIG 6, SHT 4) (NOT AVAILABLE WITH -LC, -GP, OR -FL) (NOT AVAILABLE WITH -120 & -150 POS)  
 -L: LATCHING (USE QSH-30-01-D-XX-A-L, SEE FIG 7, SHT 4) (NOT AVAILABLE WITH -LC, -GP, -FL, OR -RT1) (NOT AVAILABLE WITH -090, -120, & -150 POS)

**ROW SPECIFICATION**  
 -D: DOUBLE (USE QSH-30-01-D-XX)

No OF BANKS

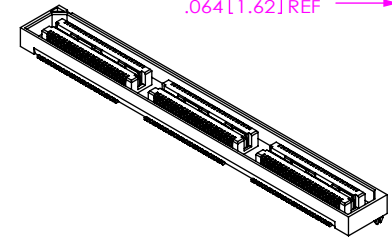
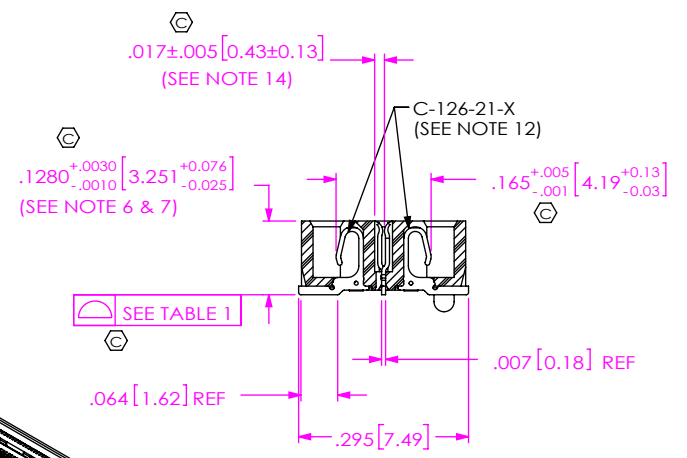
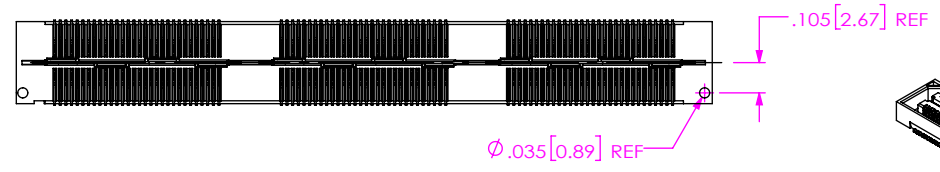
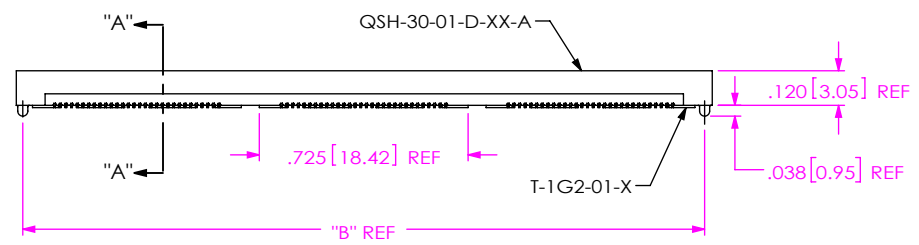
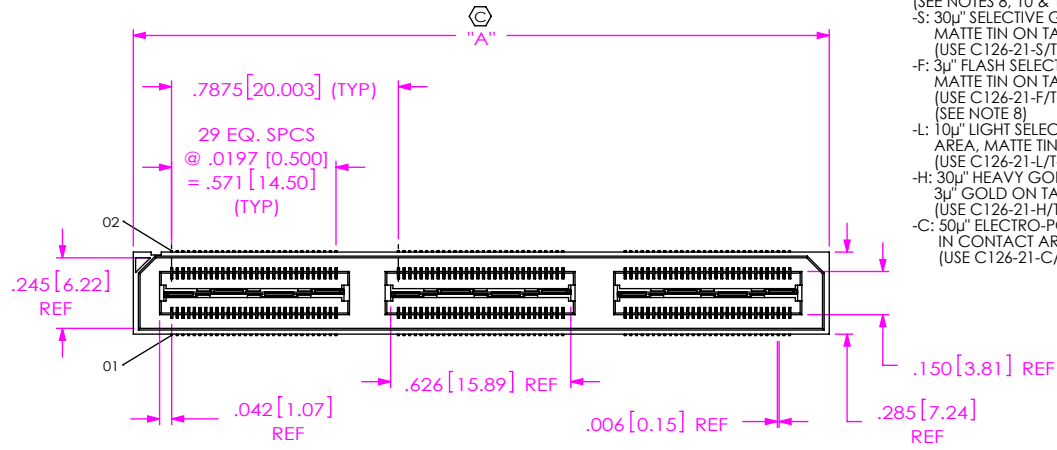
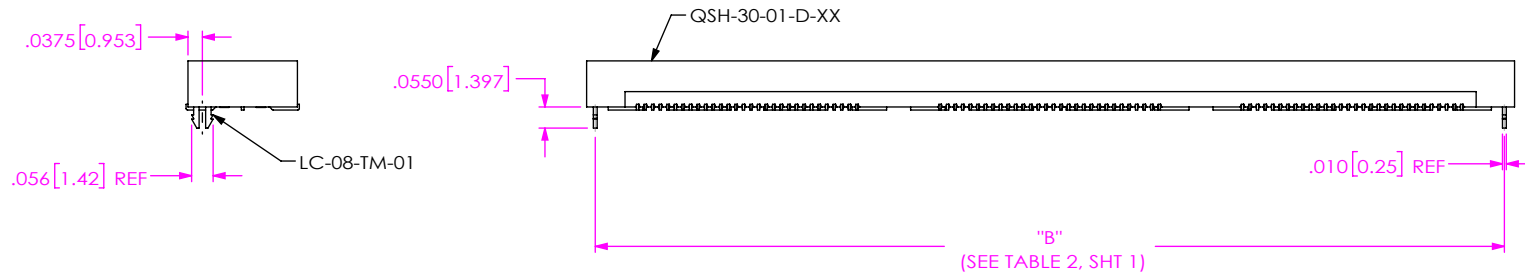

FIG 1  
 -A: ALIGNMENT PIN OPTION  
 (QSH-090-01-X-D-A SHOWN)

- NOTES:
- ⊕ REPRESENTS A CRITICAL DIMENSION.
  - NOTE DELETED.
  - ⊕ CONTACT RETENTION: 8 OZ. MINIMUM.
  - GROUND PLANE RETENTION: 8 OZ. MINIMUM.
  - BURR ALLOWANCE: .0015[0.038] MAX.
  - MAX VARIANCE: .002[0.05].
  - DIMENSION APPLIES TO CONTACT & GROUND PLANE.
  - L PLATING CAN BE SUBSTITUTED FOR -F PLATING.
  - SUB-SC-05-01-XX RETENTION TO BE 1.0 LBF IN BODY.
  - MAY SUB C-126-01 FOR C-126-21.
  - FOR NEW APPLICATIONS REQUIRING THESE POSITIONS, PLEASE CONTACT SAMTEC INTERCONNECT PROCESSING GROUP.
  - FOR -120, -150 POSITIONS USE C-269-11-X. DO NOT SUB C-126.
  - DUE TO THE HIGH AMOUNT OF INSERTION FORCE NEEDED, THE -LC OPTION IS NOT COMPATIBLE WITH AUTO PLACEMENT. SAMTEC RECOMMENDS MANUAL PLACEMENT FOR ALL ASSEMBLIES WITH THE -LC OPTION.
  - CHECK ONCE PER BANK ALTERNATING SIDES FOR MULTIPLE BANK PARTS.
  - SIDE WALLS ARE RIBBED AS NECESSARY TO CONTROL BOW.
  - TR OPTION ORDERS INVOLVING PARTIAL REEL QUANTITIES MAY BE PACKAGED ACCORDING TO THE SAMTEC PACKAGING EFFICIENCY STANDARDS (SPES) FOUND ON WWW.SAMTEC.COM.
  - FR OPTIONS WILL BE SHIPPED AT THE MAX QUANTITY PER REEL, BASED ON OPTIONS SELECTED.

UNLESS OTHERWISE SPECIFIED, DIMENSIONS ARE IN INCHES. TOLERANCES ARE: DECIMALS .XX: ±.01[.3] .XXX: ±.005[.13] .XXXX: ±.0020[.051]	<b>PROPRIETARY NOTE</b> THIS DOCUMENT CONTAINS CONFIDENTIAL AND PROPRIETARY INFORMATION AND ALL DESIGN, MANUFACTURING, REPRODUCTION, USE, PATENT RIGHTS AND SALES RIGHTS ARE EXPRESSLY RESERVED BY SAMTEC, INC. THIS DOCUMENT SHALL NOT BE DISCLOSED, IN WHOLE OR PART, TO ANY UNAUTHORIZED PERSON OR ENTITY NOR REPRODUCED, TRANSFERRED OR INCORPORATED IN ANY OTHER PROJECT IN ANY MANNER WITHOUT THE EXPRESS WRITTEN CONSENT OF SAMTEC, INC.	<b>samtec</b> 520 PARK EAST BLVD, NEW ALBANY, IN 47150 PHONE: 812-944-6733 FAX: 812-948-5047 e-Mail info@SAMTEC.com code 55322
<b>MATERIAL:</b> DO NOT SCALE DRAWING SHEET SCALE: 3:2	<b>DESCRIPTION:</b> .5mm DOUBLE ROW HS SOCKET ASSEMBLY	
INSULATOR: LCP UL94V-0, COLOR: BLACK CONTACT & GROUND PLANE: PHOS BRONZE	DWG. NO. QSH-XXX-01-X-D-XXX	
F:\DWG\MISC\MKTG\QSH-XXX-01-X-D-XXX-MKT.SLDDRW	BY: DEAN P 05/21/1999	SHEET 1 OF 4



**FIG 2**  
 -LC: LOCKING CLIP OPTION  
 (QSH-090-01-X-D-LC SHOWN)  
 (SAME AS FIG 1, EXCEPT AS SHOWN)

No OF POS	"R"				"S"			
	-LC, -A, -FL	-GP	-RT1	-L	-LC, -A, -FL	-GP	-RT1	-L
-030	.839 [21.31]	1.216 [30.89]	1.438 [36.51]	1.048 [26.61]	.257 [6.53]	.446 [11.32]	.556 [14.13]	.361 [9.18]
-060	1.627 [41.31]	2.004 [50.89]	2.225 [56.52]	1.835 [46.61]	.651 [16.53]	.839 [21.32]	.950 [24.13]	.755 [19.18]
-090	2.417 [61.38]	2.791 [70.89]	3.013 [76.52]	2.623 [66.61]	1.046 [26.56]	1.233 [31.32]	1.344 [34.13]	1.149 [29.18]
-120	3.204 [81.38]	3.579 [90.89]	N/A	N/A	1.440 [36.56]	1.627 [41.32]	N/A	N/A
-150	3.991 [101.37]	4.366 [110.90]	N/A	N/A	1.833 [46.56]	2.021 [51.32]	N/A	N/A

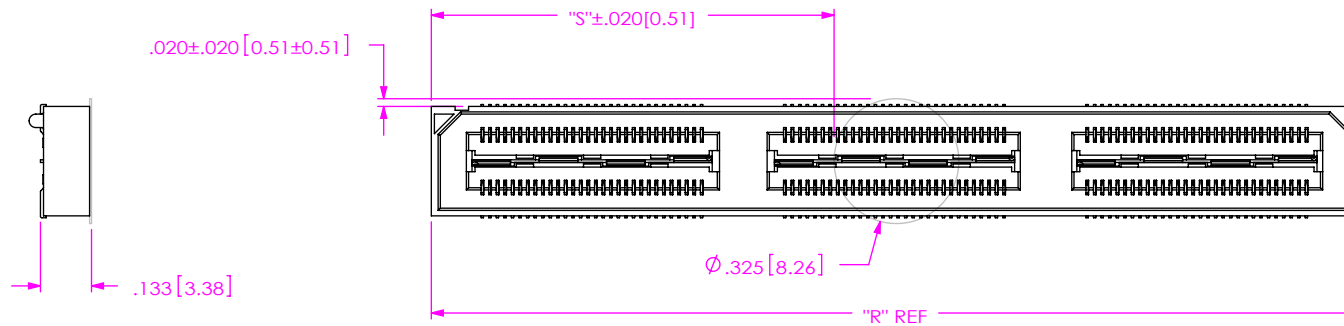

**FIG 3**  
 -K: POLYIMIDE FILM PAD  
 (USE K-DOT-.325-.450-.005)

<p>DO NOT SCALE DRAWING</p> <p>SHEET SCALE: 2:1</p>	<p><b>PROPRIETARY NOTE</b></p> <p>THIS DOCUMENT CONTAINS CONFIDENTIAL AND PROPRIETARY INFORMATION AND ALL DESIGN, MANUFACTURING, REPRODUCTION, USE, PATENT RIGHTS AND SALES RIGHTS ARE EXPRESSLY RESERVED BY SAMTEC, INC. THIS DOCUMENT SHALL NOT BE DISCLOSED, IN WHOLE OR PART, TO ANY UNAUTHORIZED PERSON OR ENTITY NOR REPRODUCED, TRANSFERRED OR INCORPORATED IN ANY OTHER PROJECT IN ANY MANNER WITHOUT THE EXPRESS WRITTEN CONSENT OF SAMTEC, INC.</p>	 <p>520 PARK EAST BLVD, NEW ALBANY, IN 47150                  PHONE: 812-944-6733 FAX: 812-948-5047                  e-Mail: info@SAMTEC.com code 55322</p>
	<p>DESCRIPTION:</p> <p>.5mm DOUBLE ROW HS SOCKET ASSEMBLY</p>	
	<p>DWG. NO.</p> <p><b>QSH-XXX-01-X-D-XXX</b></p>	
<p>BY: DEAN P 05/21/1999</p>		<p>SHEET 2 OF 4</p>

TABLE 4		
POS	"C"	"D"
-030	1.216 [30.89]	1.013 [25.73]
-060	2.004 [50.89]	1.801 [45.73]
-090	2.791 [70.89]	2.588 [65.74]
-120	3.579 [90.89]	3.376 [85.74]
-150	4.366 [110.90]	4.163 [105.74]

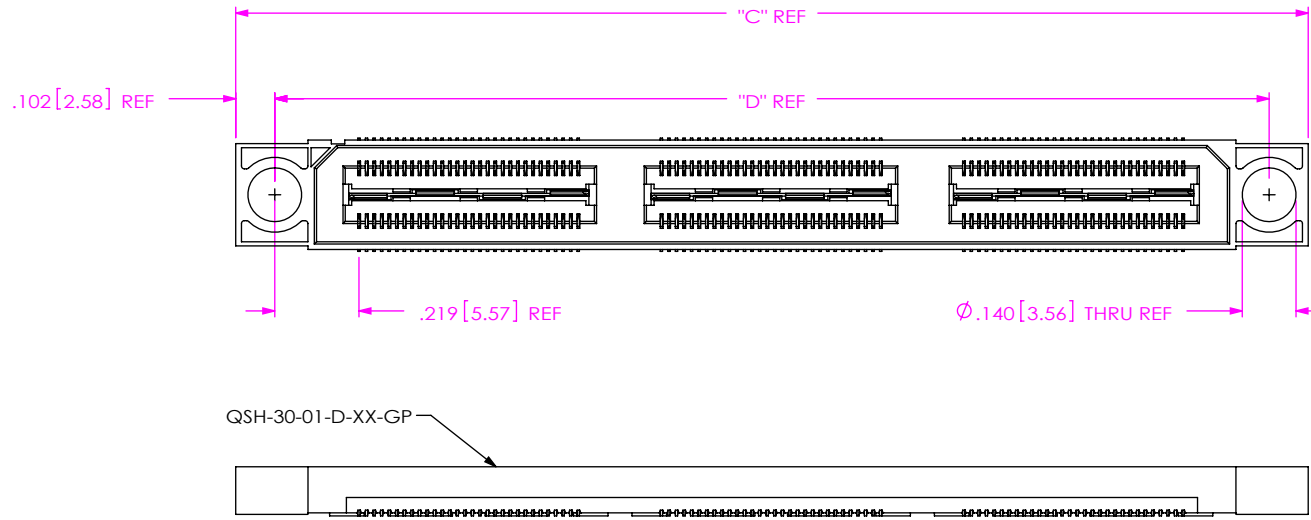

FIG 4  
 -GP: GUIDE POSTS  
 (QSH-090-01-X-D-GP SHOWN)  
 (SAME AS FIG 1, EXCEPT AS SHOWN)

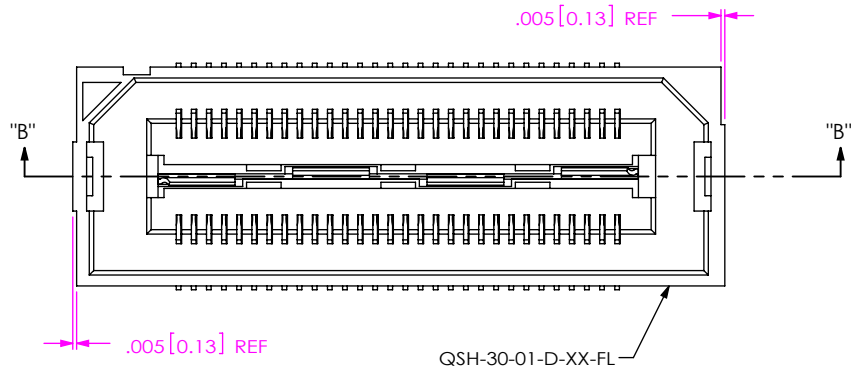
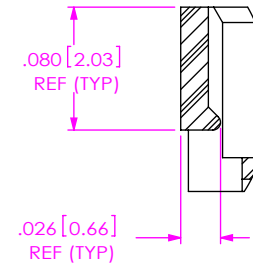
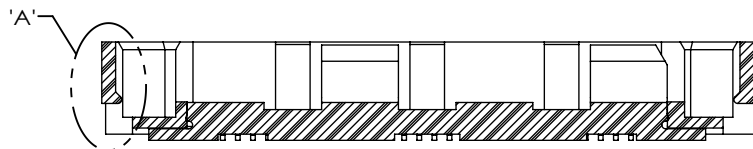

FIG 5  
 -FL: FRICTION LOCKS  
 (QSH-030-01-X-D-FL SHOWN)  
 (NOT AVAILABLE WITH -GP OPTION)  
 (SAME AS FIG 1, EXCEPT AS SHOWN)



DETAIL 'A'  
 SCALE 8 : 1



SECTION "B"-"B"  
 SCALE 4 : 1

DO NOT SCALE DRAWING  SHEET SCALE: 2:1	<p><b>PROPRIETARY NOTE</b></p> <p>THIS DOCUMENT CONTAINS CONFIDENTIAL AND PROPRIETARY INFORMATION AND ALL DESIGN, MANUFACTURING, REPRODUCTION, USE, PATENT RIGHTS AND SALES RIGHTS ARE EXPRESSLY RESERVED BY SAMTEC, INC. THIS DOCUMENT SHALL NOT BE DISCLOSED, IN WHOLE OR PART, TO ANY UNAUTHORIZED PERSON OR ENTITY NOR REPRODUCED, TRANSFERRED OR INCORPORATED IN ANY OTHER PROJECT IN ANY MANNER WITHOUT THE EXPRESS WRITTEN CONSENT OF SAMTEC, INC.</p>	<p><b>samtec</b></p> <p>520 PARK EAST BLVD, NEW ALBANY, IN 47150                  PHONE: 812-944-6733 FAX: 812-948-5047                  e-Mail: info@SAMTEC.com code 55322</p>
	DESCRIPTION: .5mm DOUBLE ROW HS SOCKET ASSEMBLY	
	DWG. NO. <b>QSH-XXX-01-X-D-XXX</b>	
BY: DEAN P      05/21/1999      SHEET 3 OF 4		

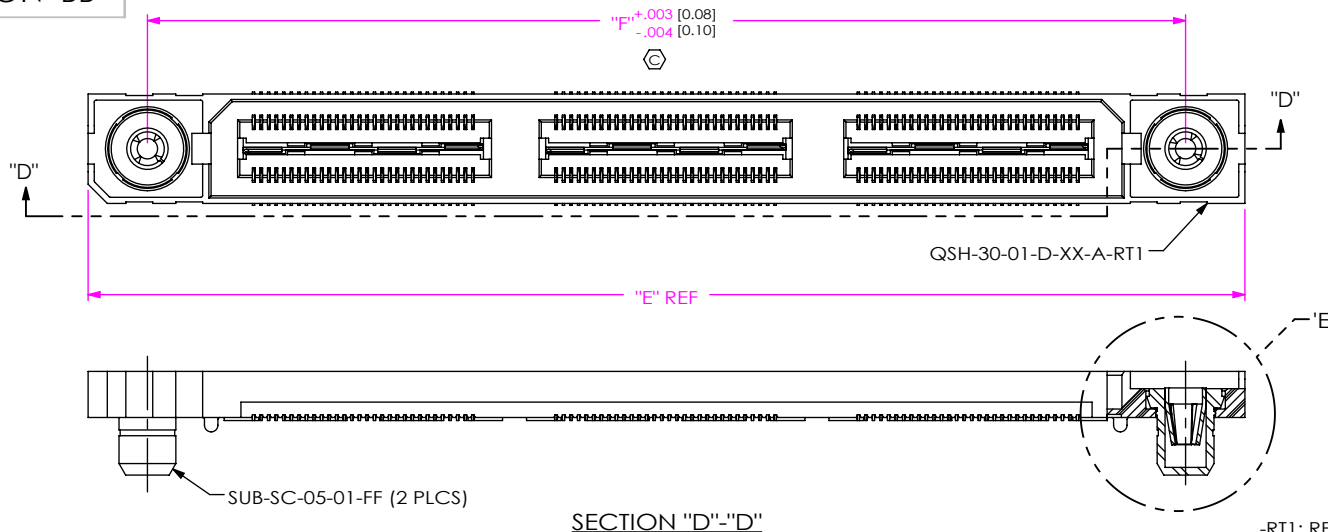

SECTION "D"-"D"

POS	"E"	"F"
-030	1.438 [36.51]	1.129 [28.66]
-060	2.225 [56.52]	1.916 [48.67]
-090	3.013 [76.52]	2.704 [68.67]
-120	N/A	N/A
-150	N/A	N/A

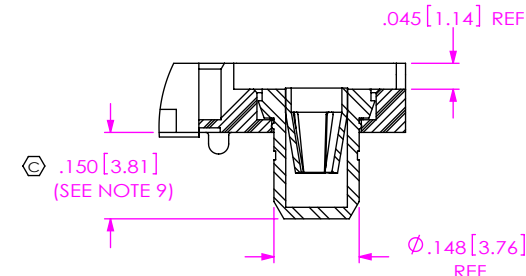

**FIG 6**  
 -RT1: RETENTION OPTION  
 (MUST USE -A OPTION)  
 (QSH-090-01-X-D-A-RT1 SHOWN)  
 (NOT AVAILABLE WITH -LC, -GP, OR -FL OPTIONS)  
 (NOT AVAILABLE WITH -120 & -150 POS)  
 (SAME AS FIG 1, EXCEPT AS SHOWN)

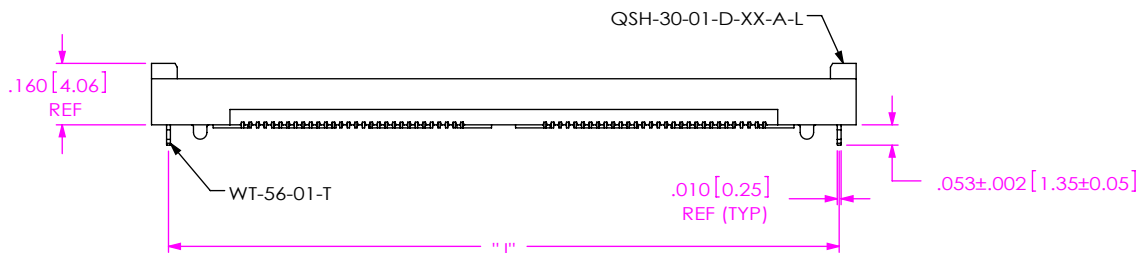
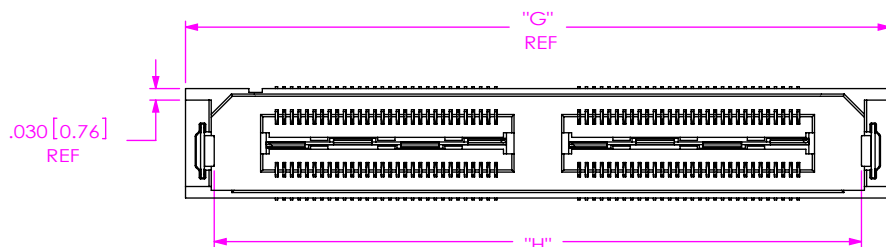

**FIG 7**  
 -L: RETENTION OPTION  
 (QSH-060-01-X-D-A-L SHOWN)  
 (NOT AVAILABLE WITH -LC, -GP, -FL, OR -RT1 OPTIONS)  
 (NOT AVAILABLE WITH -090, -120, & -150 POS)  
 (SAME AS FIG 1, EXCEPT AS SHOWN)

POS	"G"	"H"	"J"
-030	1.048 [26.61]	.897 [22.78]	.959 [24.36]
-060	1.835 [46.61]	1.684 [42.78]	1.747 [44.36]
**090	2.623 [66.61]	2.472 [62.78]	2.534 [64.36]

(\*\* = NOT RELEASED)

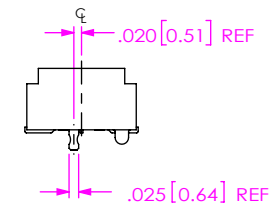

**PROPRIETARY NOTE**  
 THIS DOCUMENT CONTAINS CONFIDENTIAL AND PROPRIETARY INFORMATION AND ALL DESIGN, MANUFACTURING, REPRODUCTION, USE, PATENT RIGHTS AND SALES RIGHTS ARE EXPRESSLY RESERVED BY SAMTEC, INC. THIS DOCUMENT SHALL NOT BE DISCLOSED, IN WHOLE OR PART, TO ANY UNAUTHORIZED PERSON OR ENTITY NOR REPRODUCED, TRANSFERRED OR INCORPORATED IN ANY OTHER PROJECT IN ANY MANNER WITHOUT THE EXPRESS WRITTEN CONSENT OF SAMTEC, INC.

**samtec**  
 520 PARK EAST BLVD, NEW ALBANY, IN 47150  
 PHONE: 812-944-6733 FAX: 812-948-5047  
 e-Mail info@SAMTEC.com code 55322

DO NOT SCALE DRAWING  
 SHEET SCALE: 2:1

DESCRIPTION:  
 .5mm DOUBLE ROW HS SOCKET ASSEMBLY  
 DWG. NO.

**QSH-XXX-01-X-D-XXX**

BY: DEAN P 05/21/1999 SHEET 4 OF 4