

SPECIFICATION SHEET

SPECIFICATION SHEET NO.	Q0129 - XP27M00000S416
DATE	Jan. 29, 2023
REVISION	A0
DESCRIPTION	MHz SMD Crystal, L6.0*W3.5*H1.2mm, Glass Seal, 2 Pads, CMG632 series 27.000MHz, Tolerance +/-30ppm, Load Capacitor 16pF, Frequency stability +/-30ppm @Operating Temp. Range -40°C ~+85°C, ESR 50 ohm Max, Reflow Profile Condition 260 °C Max. Tape/Reel, 1000pcs/Reel RoHS/RoHS III compliant, RoHS Annex III lead Exemption (exempt per RoHS EU 2015/863)
CUSTOMER	
CUSTOMER PART NUMBER	
CROSS REF. PART NUMBER	
ORIGINAL PART NUMBER	TGS CMG632 27M0A30-16-30-40-50 TLH
PART CODE	XP27M00000S416

VENDOR APPROVE			
Issued/Checked/Approved			
DATE: Jan. 29, 2023			

CUSTOMER APPROVE	
DATE:	

1/29/2023

MHz SMD CRYSTAL GLASS SEAL 6035 TYPE 2 PADS

MAIN FEATURE

- MHz SMD Crystal Glass seal, 2 Pads, L6.0*W3.5*H1.2mm
- Low cost, High precision, High frequency stability
- Reflow Profile Condition 260 °C Max.
- Cross more competitors part
- RoHS/RoHS III compliant, RoHS Annex III lead Exemption (exempt per RoHS EU 2015/863)



APPLICATION

- Measurement Instrument
- Communication Electronics

PART CODE GUIDE

RFQ

Request For Quotation

XP	27M00000	S	416
1	2	3	4

- 1) XP: Part family Code for SMD Crystal Glass seal, L6.0*W3.5*H1.2mm, 2 Pads, CMG632 series
- 2) 27M00000: Frequency range code for 27.0000MHz
- 3) S: SMD type, Package Tape/Reel, 1000pcs/Reel
- 4) 416: Specification code for original part no. **TGS CMG632 27M0A30-16-30-40-50 TLH**

MHZ SMD CRYSTAL GLASS SEAL 6035 TYPE 2 PADS

DIMENSION (Unit: mm, +/-0.2mm)

Image for reference



Top View



Marking

Frequency Range
or Internal control
code

Bottom type 1
View



OR

Bottom Type 2
View



Pin Configuration

#1 Crystal

#2 Crystal

Side View



MHZ SMD CRYSTAL GLASS SEAL 6035 TYPE 2 PADS
ELECTRICAL PARAMETERS

Parameter	Part No. Symbol	Units	Value			Condition
			Min.	Typical	Max.	
Original Manufacturer	TGS		TGS Crystals			
Holder Type	CMG632		MHz SMD Crystal, Glass Seal, L6.0*W3.5*H1.2mm, 2 pads			
Frequency Range	27M0	MHz	27.000			
Mode of Oscillation	A		AT Fundamental			
Frequency Tolerance	30	ppm	-30		+30	@25°C
Load Capacitance	-16	pF	16			
Stability over Operation Temperature	-30	ppm	-30		+30	
Operation Temperature	-40	°C	-40		+85	
Storage Temperature		°C	-40		+85	
Equivalent Series Resistance (ESR)	50	Ω			50	
Drive Level		μW			100	
Shunt Capacitance (C0)		pF	0		5.0	
Motional Capacitance (C1)		fF	N/A			
DLD2		Ω	N/A			
FLD2		ppm	N/A			
RDL2		Ω	N/A			
SPDB		dB	N/A			
Aging		ppm/year			±3	@1 st year
Insulation Resistance		MΩ	500			@100VDC ± 15Vdc
Others	Package	T	Tape/Reel, 1000pcs/Reel			
	RoHS Status	LH	RoHS III compliant, RoHS Annex III lead Exemption (exempt per RoHS EU 2015/863)			
	Add Value		N/A			
	Internal Control Code *		N/A			

 Note: 1) Original Part Number: **TGS CMG632 27M0A30-16-30-40-50 TLH**

2) * Internal Control Code- 2 letter or digits; Blank: N/A

1/29/2023

MHZ SMD CRYSTAL GLASS SEAL 6035 TYPE 2 PADS

RELIABILITY

Test Items	Test Method And Conditions	Reference Documents
High Temperature High Humidity Storage	Temperature: 85°C±3°C Relative Humidity:85%RH Time: 96 Hours	JIS C5023
High Temperature Storage	Temperature: 125°C±3°C Time: 96 Hours.	MIL-STD-883E Method 1005.8
Low Temperature Storage	Temperature: -40°C±3°C Time: 96 Hours.	MIL-STD-883E Method 1013
Thermal Shock	Temperature 1: -55°C±5°C Temperature 2: 85°C±5 °C Temperature change between T1 and T2 5 min 10cycles maintain T1 and T2 for 30 minutes each cycle	MIL-STD-202F Method 107 Condition A
Resistance to Solder Heat	Solder Temperature: 260°C±5°C Time: 10±1 Seconds	MIL-STD-202F Method 210E
Solderability	The solder pot temperature is 245±5°C , dwell time 5±0.5sec	J-STD-002B
Drop Test	3 Times Free Fall from 50cm height table to 3cm thickness hard wood board	J-STD-002B
Mechanical Shock	Half sine wave,1000 G 3 Times for all 3 directions(X,Y Z)	MIL STD 202F Method 213B
Vibration	Frequency Range: 10Hz ~ 55Hz Amplitude: 0.75mm 2 Hours in each direction, total 6 Hours	MIL-STD-883E Method 2007.3
Leakage Test	Take measurements with a helium Leakage detector Leakage Rate≤1×10 ⁻³ Pa cm ³ /s	MIL-STD-883E

MHZ SMD CRYSTAL GLASS SEAL 6035 TYPE 2 PADS

SUGGESTED REFLOW PROFILE (For Reference Only)

Total time: 200 Sec. Max. Solder melting point: 220°C



Profile Feature		Pb-Free Assembly
Average Ramp-up Rate (Ts Max to Tp)		3°C/second Max
Preheat	Temperature Min (Ts Min.)	125°C
	Temperature Max (Ts Max.)	200°C
	Time (ts Min. to ts Max.)	60 ~ 180 seconds
Time maintained above	Temperature (Tl)	217°C
	Time (tL)	60 ~ 150 seconds
Peak/Classification Temperature (Tp)		260 °C
Time within 5°C of actual Peak Temperature (tp)		20 ~ 40 seconds
Ramp-down rate		6 °C /Second Max.
Time 25 °C to Peak Temperature		8 minutes Max.
Suggest reflow times		3 Times Max.

MHZ SMD CRYSTAL GLASS SEAL 6035 TYPE 2 PADS

TAPE/REEL (Unit: mm, 1000pcs/Reel)

All Devices are packed in accordance with EIA standard RS-481-2 and specifications., 1000pcs/Reel



Code	Dimension (mm)
A	1.70
B	5.45
C	3.65
D	8.00
E	12.0

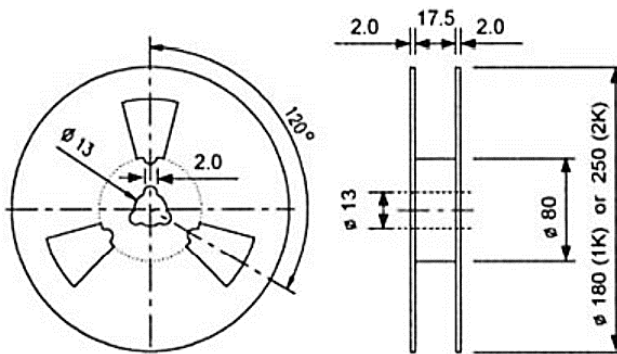

DISCLAIMER

NextGen Components, Inc. reserves the right to make changes to the product(s) and or information contained herein without notice. No liability is assumed as a result of their use or application. No rights under any patent accompany the sale of any such product(s) or information