

ANT-5GWWS4-ccc Cellular Sub-6 5G Antenna

The ANT-5GWWS4 is a dipole, blade-style antenna for 5G New Radio, LTE, and cellular IoT (LTE-M, NB-IoT) applications requiring a cost-effective but stylish and very capable antenna solution.

The ANT-5GWWS4 antenna is made from rugged ABS plastic and is available in black or white. The hinged design allows for the antenna to be positioned for optimum performance and reduces the potential for damage from impact compared to a fixed whip design. The antenna is available with an SMA plug (male pin) connector.



ANT-5GWWS4-SMA-W shown

Features

- Performance at 3300 MHz to 3800 MHz
 - VSWR: ≤ 3.6
 - Peak Gain: 4.9 dBi
 - Efficiency: 58%
- Performance at 698 MHz to 803 MHz
 - VSWR: ≤ 3.9
 - Peak Gain: 2.8 dBi
 - Efficiency: 60%
- Hinged design with detents for straight, 45 degree and 90 degree positioning
- SMA plug (male pin) connection

Applications

- Worldwide 5G/4G/3G/2G
- Cellular IoT: LTE-M (Cat-M1) and NB-IoT
- Internet of Things (IoT) devices
- Home and business networking

Ordering Information

Part Number	Description
ANT-5GWWS4-SMA	Cellular 5G blade-style antenna with SMA plug (male pin), black
ANT-5GWWS4-SMA-W	Cellular 5G blade-style antenna with SMA plug (male pin), white

Available from Linx Technologies and select distributors and representatives.

Table 1. Electrical Specifications

Bands	Frequency Range	VSWR (max.)	Peak Gain (dBi)	Avg. Gain (dBi)	Efficiency (%)
71	617 MHz to 698 MHz	4.3	1.7	-1.8	69
12, 13, 14, 17, 26, 28, 29	698 MHz to 803 MHz	3.9	2.8	-2.6	60
5, 8, 20	791 MHz to 960 MHz	4.7	2.7	-3.7	48
1, 2, 3, 4, 25, 66	1710 MHz to 2200 MHz	3.2	4.4	-2.4	63
30, 40	2300 MHz to 2400 MHz	3.2	4.1	-2.6	57
7, 41	2496 MHz to 2690 MHz	2.5	3.4	-1.2	79
22, 42, 43, 48, 49, 52, n77, n78	3300 MHz to 3800 MHz	3.6	4.9	-2.8	58
48 (CBRS)	3550 MHz to 3700 MHz	3.5	4.8	-2.2	61
C-Band	3700 MHz to 4200 MHz	3.3	4.9	-3.8	50
n79	4400 MHz to 5000 MHz	3.0	5.2	-3.1	53
Impedance	50 Ω				
Wavelength	1/2-wave				
Electrical Type	Dipole				
Radiation	Omnidirectional				
Polarization	Linear				
Max Power	1 W				

Electrical specifications and plots measured with the antenna in a 90 degree orientation on the edge of a 102 mm x 102 mm ground plane.

Table 2. Mechanical Specifications

Parameter	Value
Connection	SMA plug (male pin)
Antenna Color	Black, White (-W)
Operating Temp. Range	-20 °C to +65 °C
Weight	20.4 g (0.72 oz)
Dimensions	175.3 mm x 19.6 mm x 13.0 (6.90 in x 0.77 in x 0.51 in)

Packaging Information

The ANT-5GWWS4 antenna is individually sealed in a clear plastic bag. Distribution channels may offer alternative packaging options.

Product Dimensions

Figure 1 provides dimensions of the ANT-5GWS4-ccc. The antenna whip can be tilted 90 degrees, with a detent at 45 degrees enabling the antenna to be oriented in any direction. The rotating base allows for continuous positioning through 360 degrees even while installed.

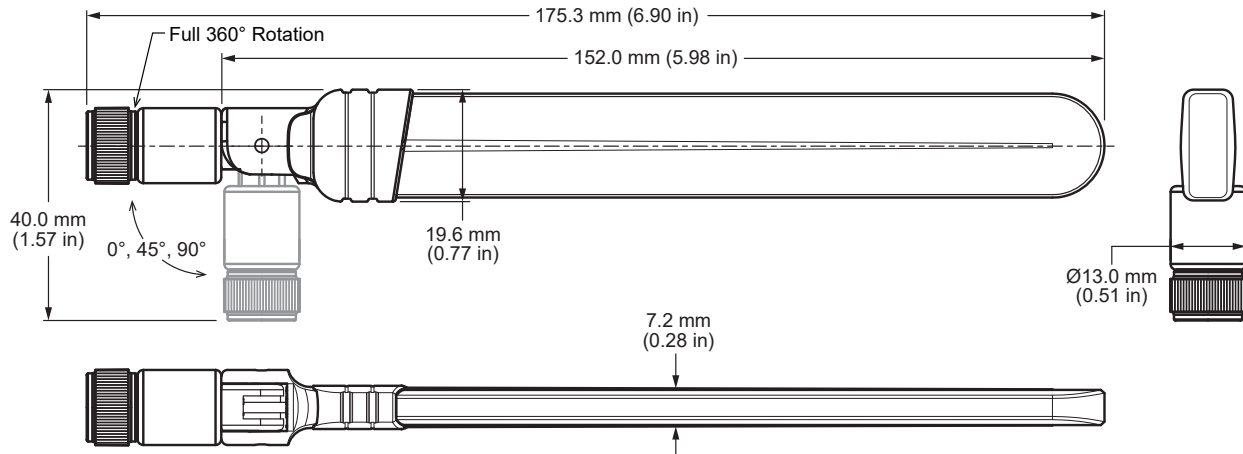
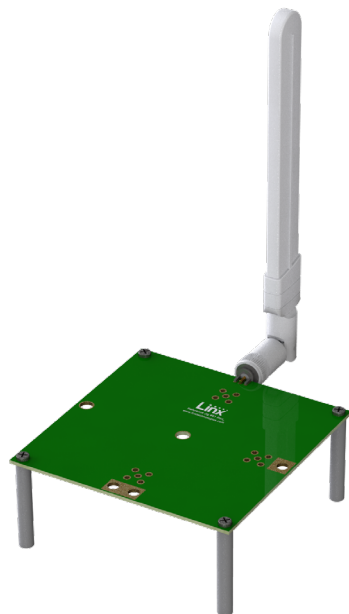

Figure 1. ANT-5GWS4-ccc Antenna Dimensions

Antenna Orientation

The ANT-5GWS4-ccc antenna is characterized in two antenna orientations as shown in Figure 2. The antenna straight orientation characterizes use of an antenna attached to an enclosure-mounted connector which is connected by cable to a printed circuit board. Although the antenna is a dipole not requiring a ground plane for function, characterization with an adjacent ground plane, (102 mm x 102 mm) provides insight into antenna performance when attached directly to a printed circuit board mounted connector. The two orientations represent the most common end-product use cases.



Edge of ground plane, bent 90 degrees



Straight, without ground plane

Figure 2. ANT-5GWS4-ccc on evaluation PCB

Edge of Ground Plane, Bent 90 Degrees

The charts on the following pages represent data taken with the antenna oriented at the edge of the ground plane, bent 90 degrees (Edge-Bent), as shown in Figure 3.

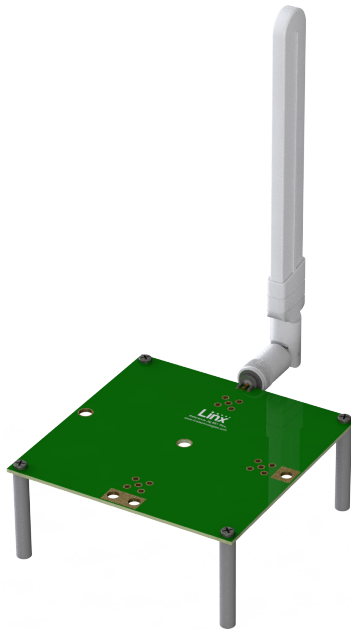

Figure 3. ANT-5GWWS4-ccc on Edge of Ground Plane, Bent 90 Degrees (Edge-Bent)

VSWR

Figure 4 provides the voltage standing wave ratio (VSWR) across the antenna bandwidth. VSWR describes the power reflected from the antenna back to the radio. A lower VSWR value indicates better antenna performance at a given frequency. Reflected power is also shown on the right-side vertical axis as a gauge of the percentage of transmitter power reflected back from the antenna.

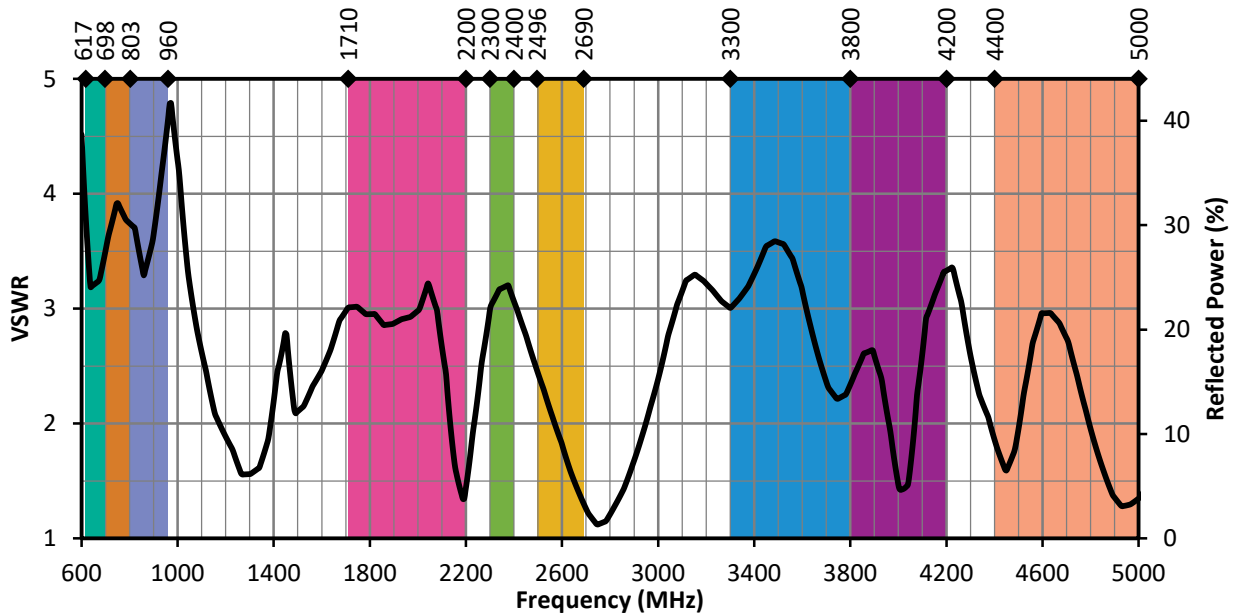

Figure 4. ANT-5GWWS4-ccc VSWR, Edge-Bent

Return Loss

Return loss (Figure 5), represents the loss in power at the antenna due to reflected signals. Like VSWR, a lower return loss value indicates better antenna performance at a given frequency.

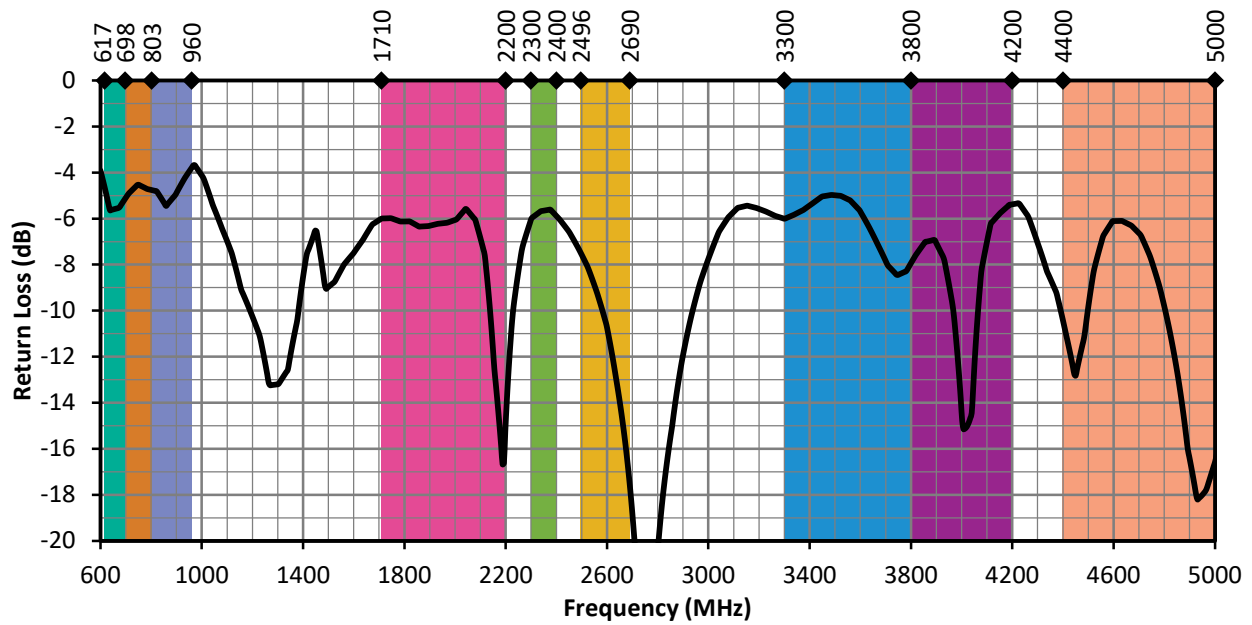

Figure 5. ANT-5GWWS4-ccc Return Loss, Edge-Bent

Peak Gain

The peak gain across the antenna bandwidth is shown in Figure 6. Peak gain represents the maximum antenna input power concentration across 3-dimensional space, and therefore peak performance at a given frequency, but does not consider any directionality in the gain pattern.

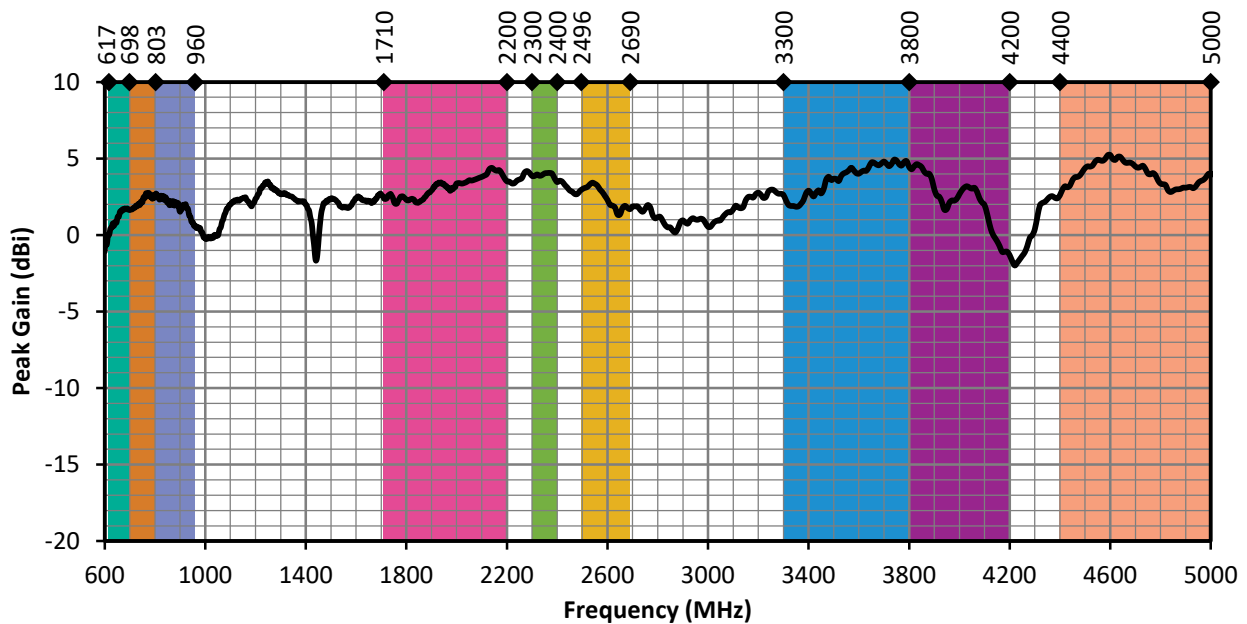

Figure 6. ANT-5GWWS4-ccc Peak Gain, Edge-Bent

Average Gain

Average gain (Figure 7), is the average of all antenna gain in 3-dimensional space at each frequency, providing an indication of overall performance without expressing antenna directionality.

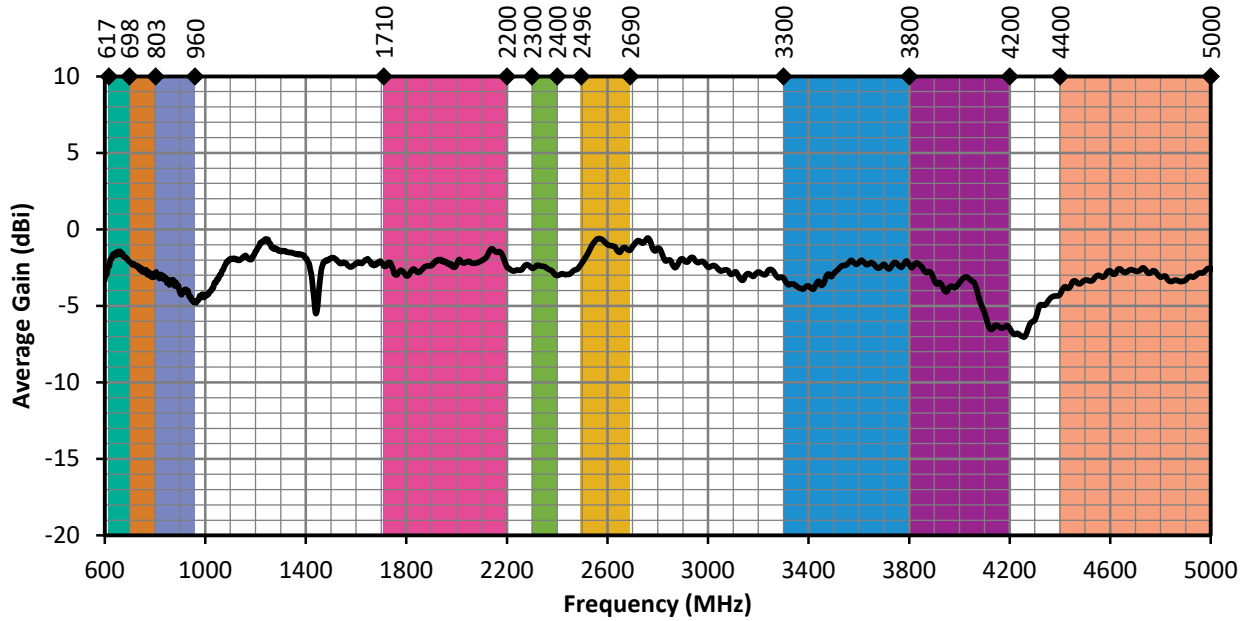

Figure 7. ANT-5GWWS4-ccc Antenna Average Gain, Edge-Bent

Radiation Efficiency

Radiation efficiency (Figure 8), shows the ratio of power delivered to the antenna relative to the power radiated at the antenna, expressed as a percentage, where a higher percentage indicates better performance at a given frequency.

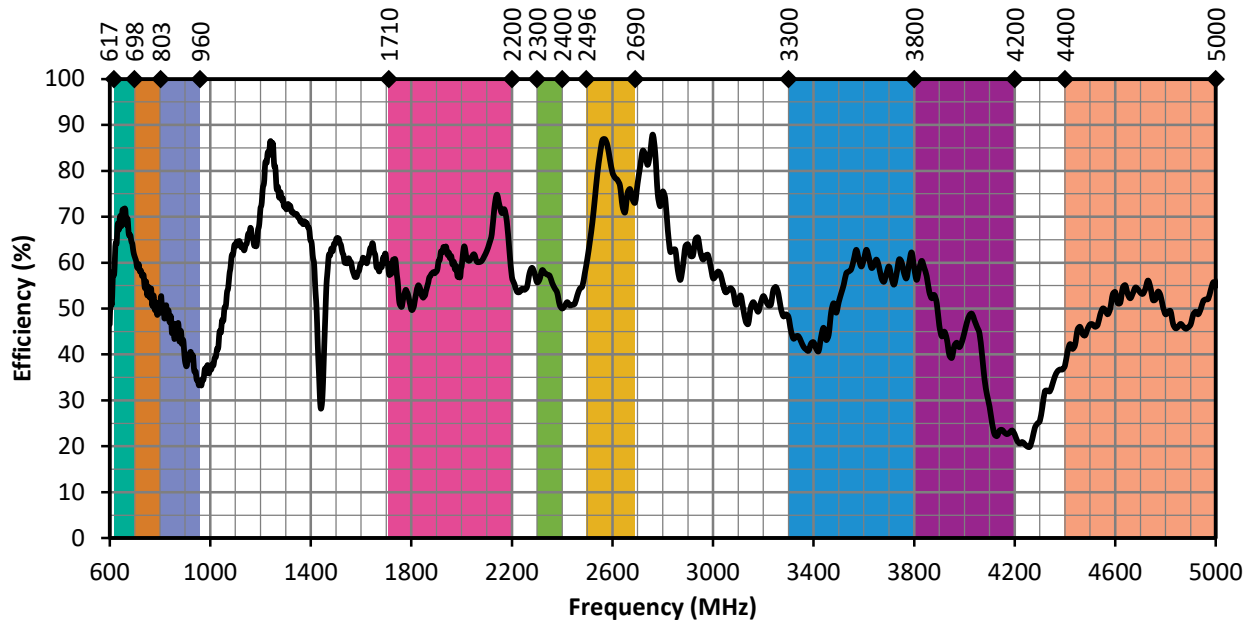
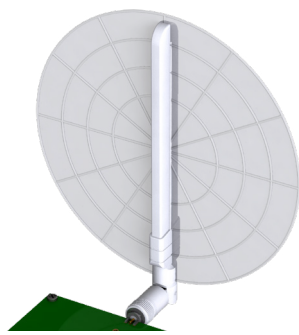

Figure 8. ANT-5GWWS4-ccc Antenna Efficiency, Edge-Bent

Radiation Patterns

Radiation patterns provide information about the directionality and 3-dimensional gain performance of the antenna by plotting gain at specific frequencies in three orthogonal planes. Antenna radiation patterns for an Edge-Bent orientation are shown in Figure 9 using polar plots covering 360 degrees. The antenna graphic at the top of the page provides reference to the plane of the column of plots below it. Note: when viewed with typical PDF viewing software, zooming into radiation patterns is possible to reveal fine detail.

Radiation Patterns - Edge-Bent



XZ-Plane Gain



YZ-Plane Gain

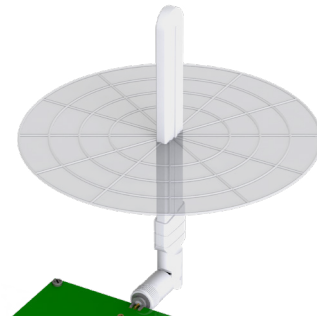

XY-Plane Gain

617 MHz to 698 MHz (660 MHz)

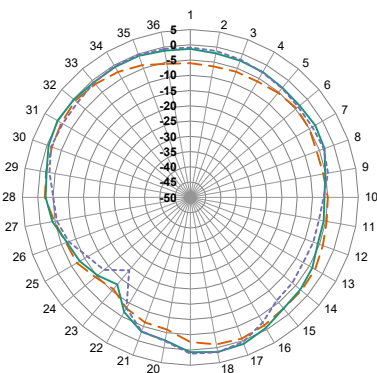

XZ-Plane Gain

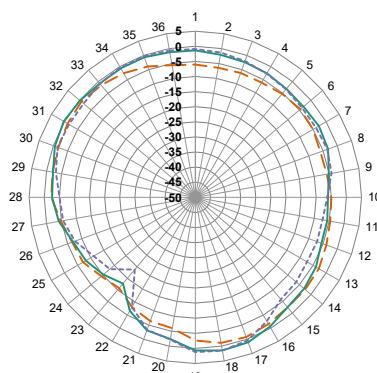

YZ-Plane Gain

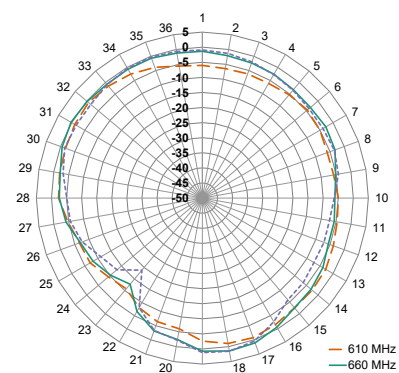

XY-Plane Gain

— 610 MHz
— 660 MHz
- - 700 MHz

698 MHz to 803 MHz (750 MHz)

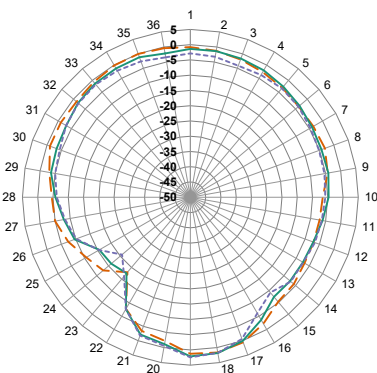

XZ-Plane Gain

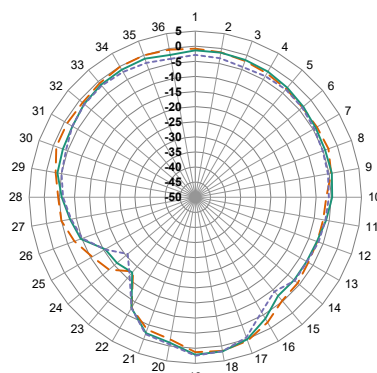

YZ-Plane Gain

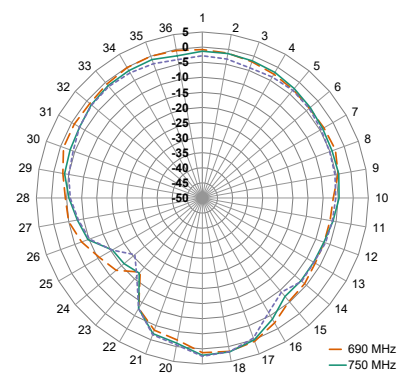

XY-Plane Gain

— 690 MHz
— 750 MHz
- - 810 MHz

Radiation Patterns - Edge-Bent

791 MHz to 960 MHz (870 MHz)

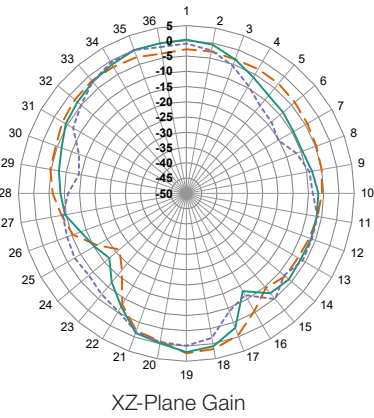

XZ-Plane Gain

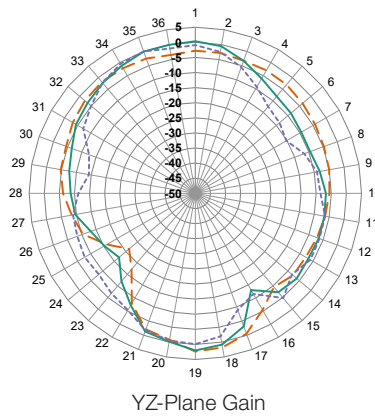

YZ-Plane Gain

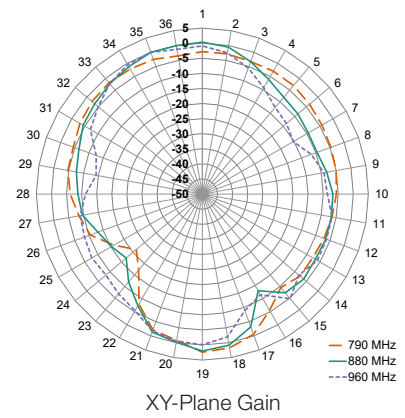

XY-Plane Gain

1710 MHz to 2200 MHz (1950 MHz)

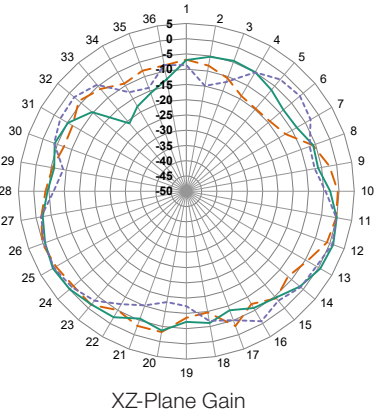

XZ-Plane Gain

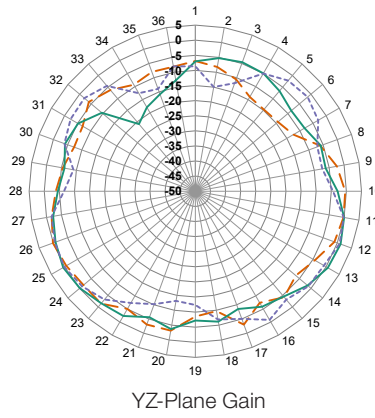

YZ-Plane Gain

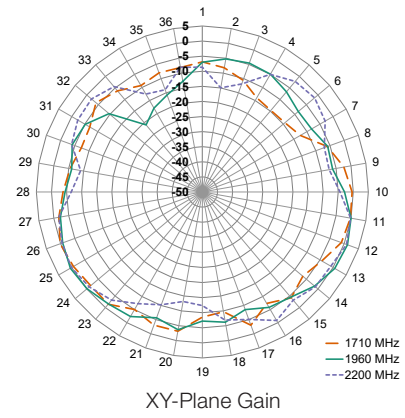

XY-Plane Gain

2300 MHz to 2400 MHz (2350 MHz)

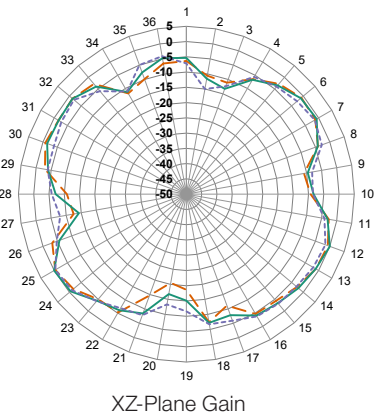

XZ-Plane Gain

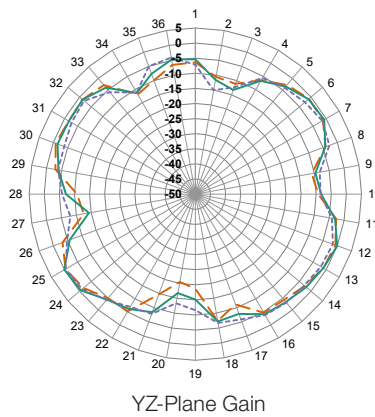

YZ-Plane Gain

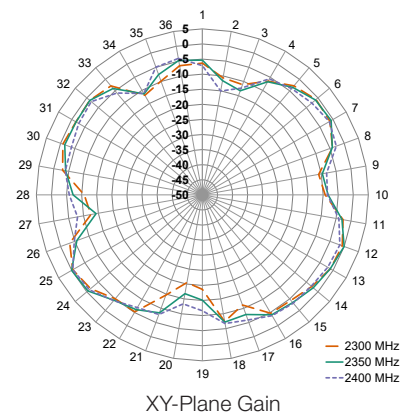

XY-Plane Gain

Radiation Patterns - Edge-Bent

2496 MHz to 2690 MHz (2590 MHz)

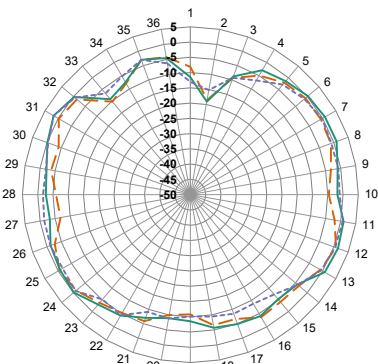

XZ-Plane Gain

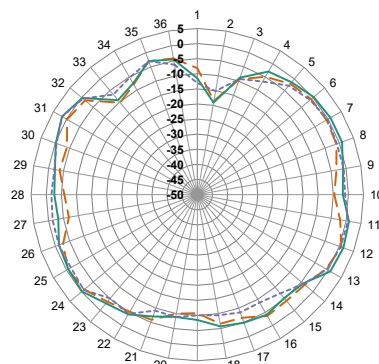

YZ-Plane Gain

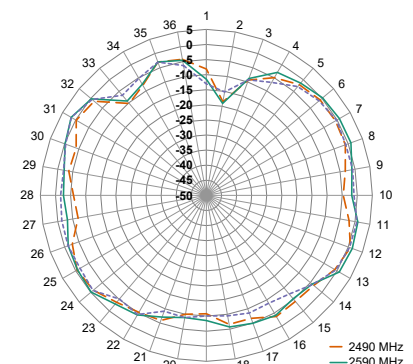

XY-Plane Gain

3300 MHz to 3800 MHz (3550 MHz)

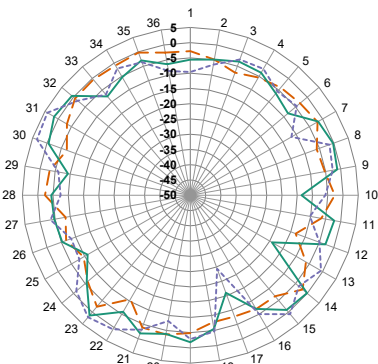

XZ-Plane Gain

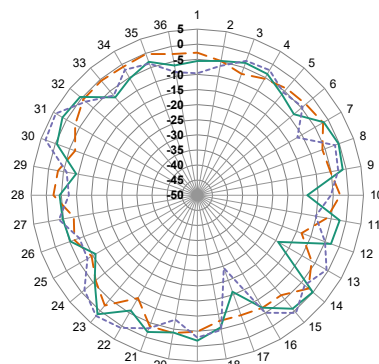

YZ-Plane Gain

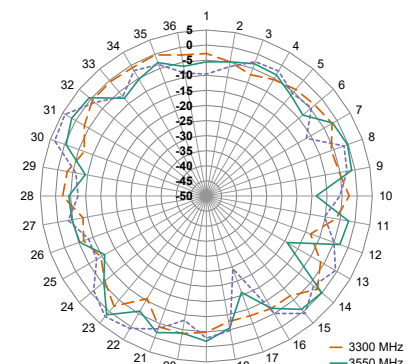

XY-Plane Gain

3550 MHz to 3700 MHz (3630 MHz)

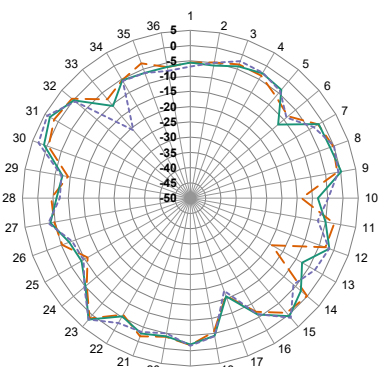

XZ-Plane Gain

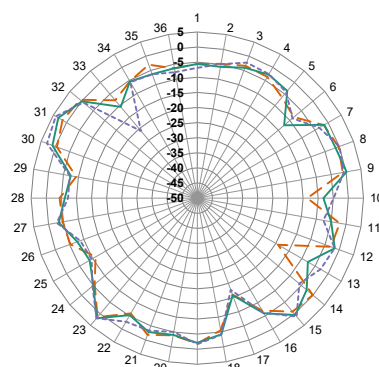

YZ-Plane Gain

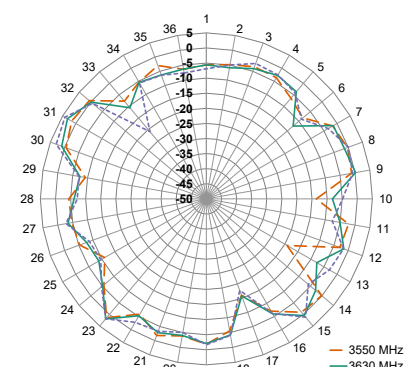

XY-Plane Gain

Radiation Patterns - Edge-Bent

3700 MHz to 4200 MHz (3950 MHz)

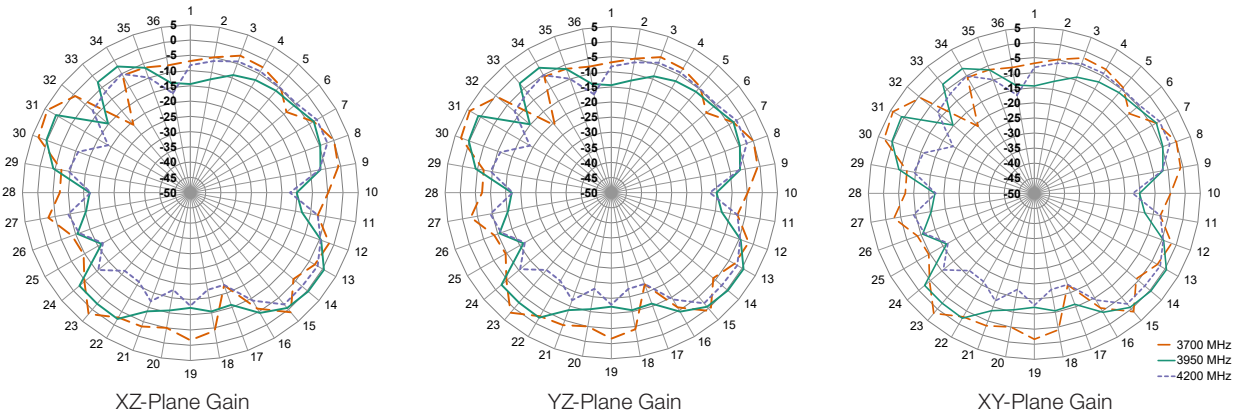

4400 MHz to 5000 MHz (4700 MHz)

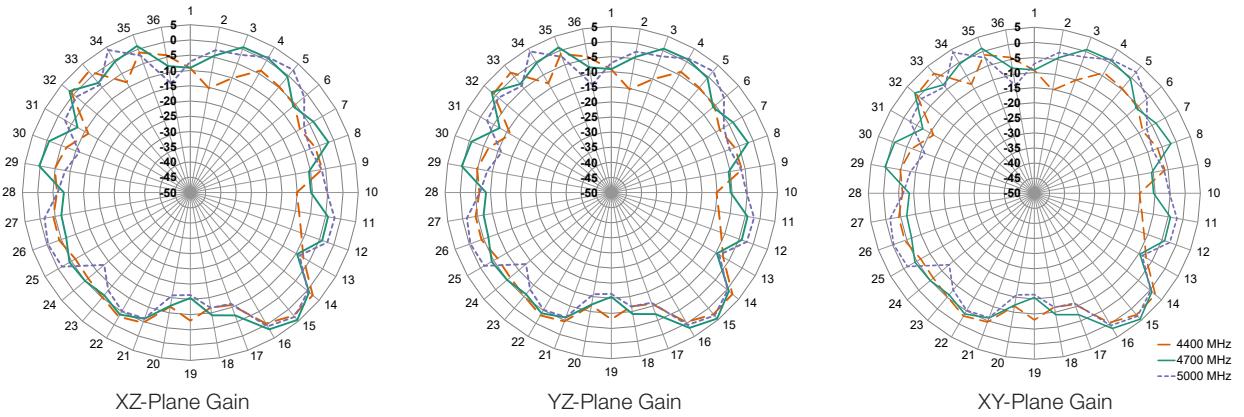

Figure 9. Radiation Patterns for ANT-5GWS4-ccc, Edge-Bent

Straight, No Ground Plane

The charts on the following pages represent data taken with the antenna oriented straight, as shown in Figure 10.



Figure 10. ANT-5GWWS4-ccc Straight, No Ground Plane (Straight)

VSWR

Figure 11 provides the voltage standing wave ratio (VSWR) across the antenna bandwidth. VSWR describes the power reflected from the antenna back to the radio. A lower VSWR value indicates better antenna performance at a given frequency. Reflected power is also shown on the right-side vertical axis as a gauge of the percentage of transmitter power reflected back from the antenna.

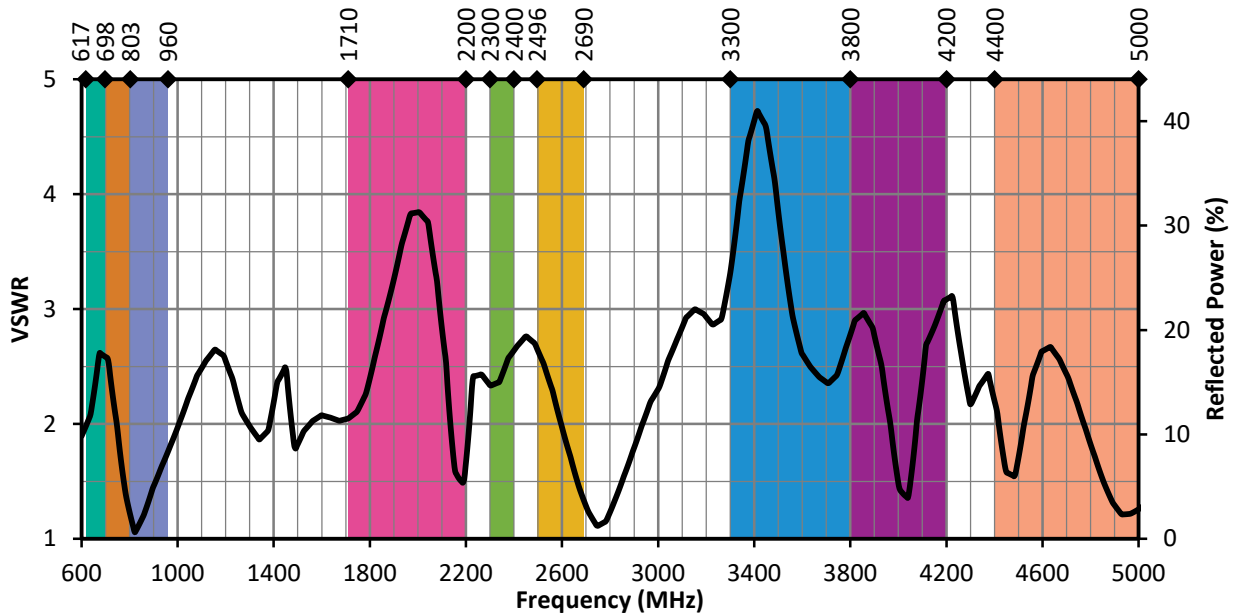

Figure 11. ANT-5GWWS4-ccc VSWR, Straight

Return Loss

Return loss (Figure 12), represents the loss in power at the antenna due to reflected signals. Like VSWR, a lower return loss value indicates better antenna performance at a given frequency.

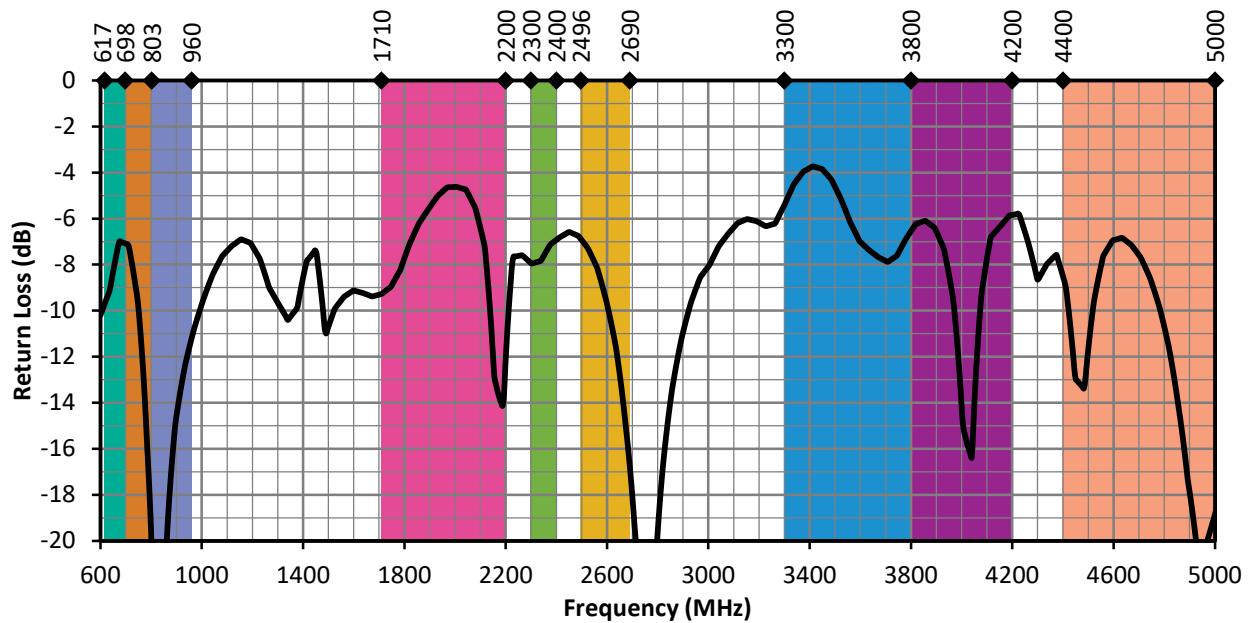

Figure 12. ANT-5GWWS4-ccc Return Loss, Straight

Peak Gain

The peak gain across the antenna bandwidth is shown in Figure 13. Peak gain represents the maximum antenna input power concentration across 3-dimensional space, and therefore peak performance at a given frequency, but does not consider any directionality in the gain pattern.

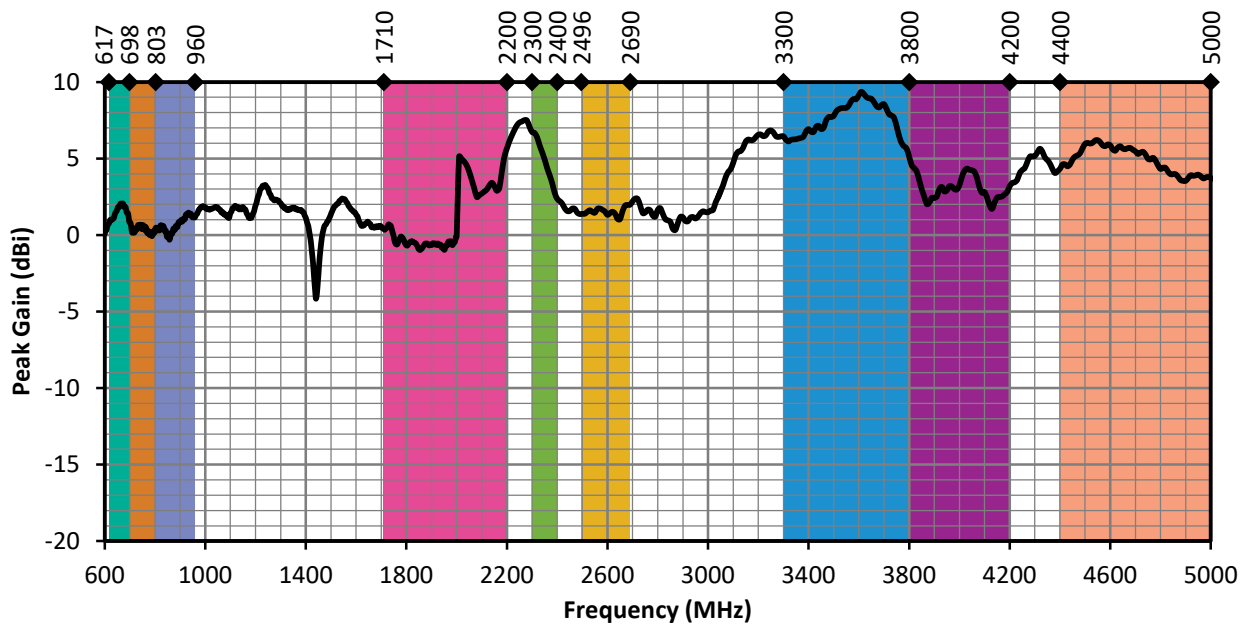

Figure 13. ANT-5GWWS4-ccc Peak Gain, Straight

Average Gain

Average gain (Figure 14), is the average of all antenna gain in 3-dimensional space at each frequency, providing an indication of overall performance without expressing antenna directionality.

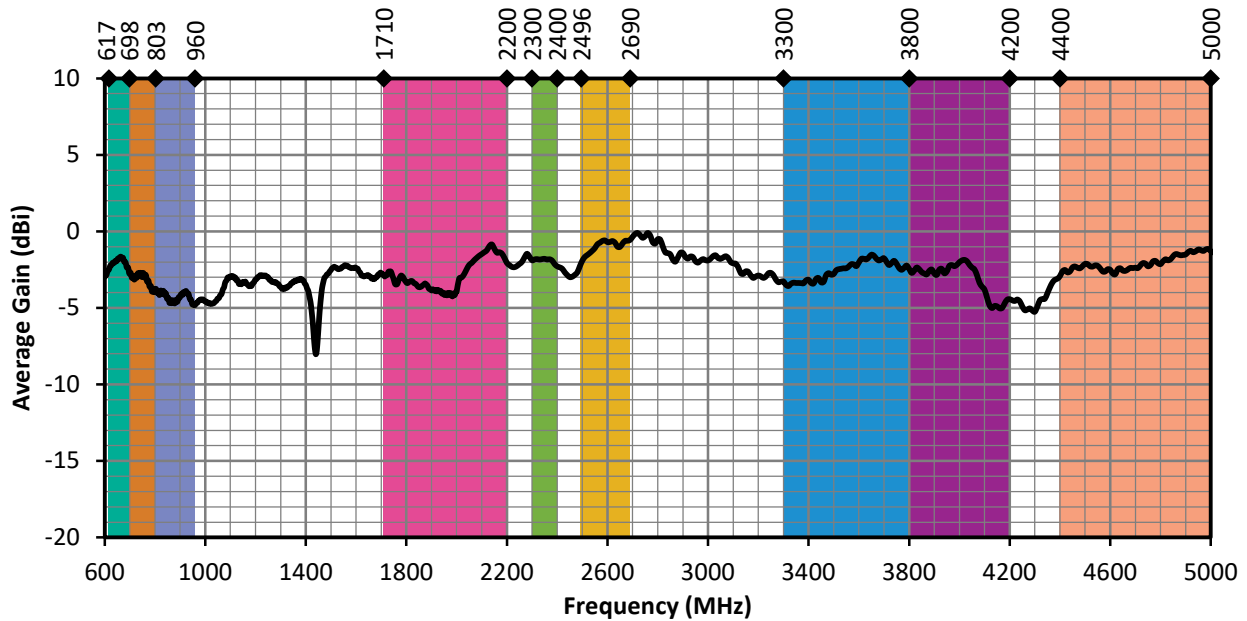

Figure 14. ANT-5GWWS4-ccc Antenna Average Gain, Straight

Radiation Efficiency

Radiation efficiency (Figure 15), shows the ratio of power delivered to the antenna relative to the power radiated at the antenna, expressed as a percentage, where a higher percentage indicates better performance at a given frequency.

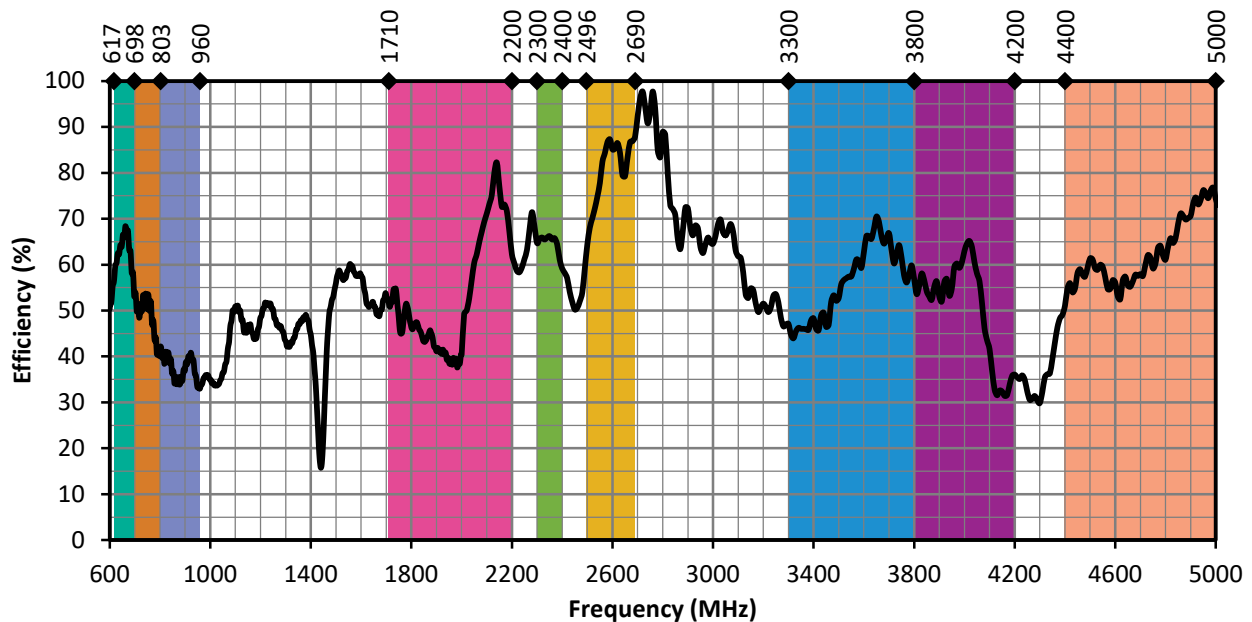

Figure 15. ANT-5GWWS4-ccc Antenna Efficiency, Straight

Radiation Patterns

Radiation patterns provide information about the directionality and 3-dimensional gain performance of the antenna by plotting gain at specific frequencies in three orthogonal planes. Antenna radiation patterns for a straight orientation are shown in Figure 16 using polar plots covering 360 degrees. The antenna graphic at the top of the page provides reference to the plane of the column of plots below it. Note: when viewed with typical PDF viewing software, zooming into radiation patterns is possible to reveal fine detail.

Radiation Patterns - Straight



XZ-Plane Gain



YZ-Plane Gain



XY-Plane Gain

617 MHz to 698 MHz (660 MHz)

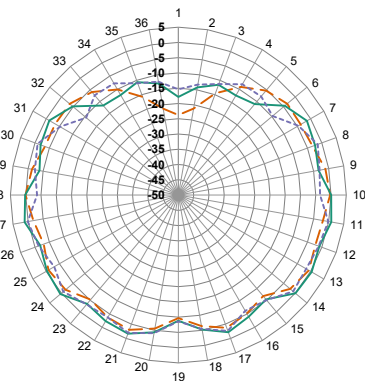

XZ-Plane Gain

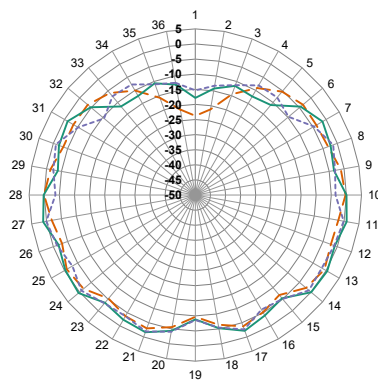

YZ-Plane Gain

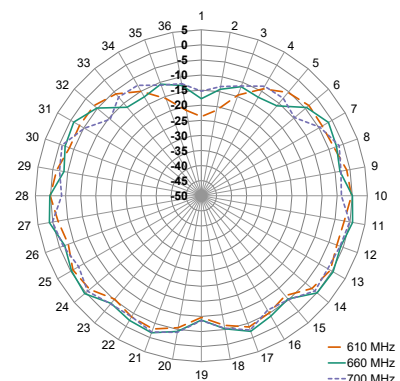

XY-Plane Gain

— 610 MHz
— 660 MHz
- - - 700 MHz

698 MHz to 803 MHz (750 MHz)

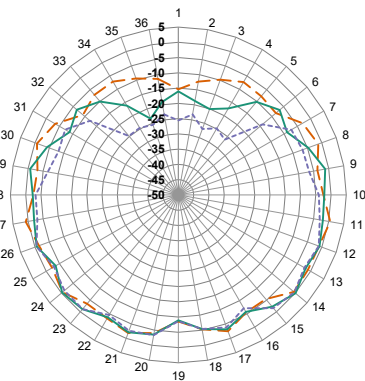

XZ-Plane Gain

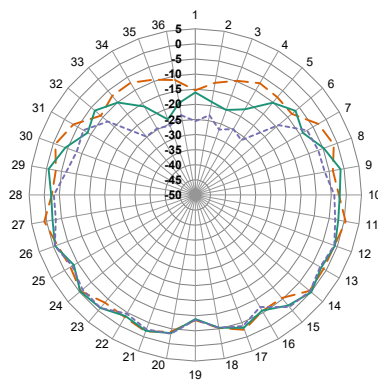

YZ-Plane Gain

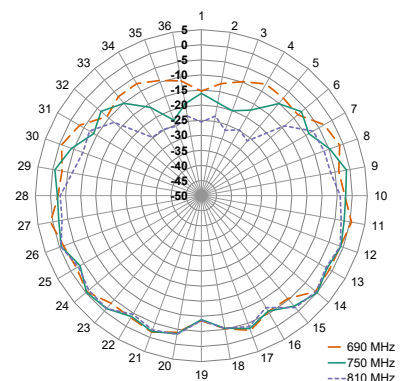

XY-Plane Gain

— 690 MHz
— 750 MHz
- - - 810 MHz

Radiation Patterns - Straight

791 MHz to 960 MHz (880 MHz)

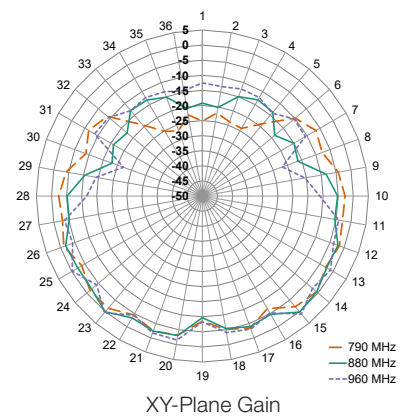
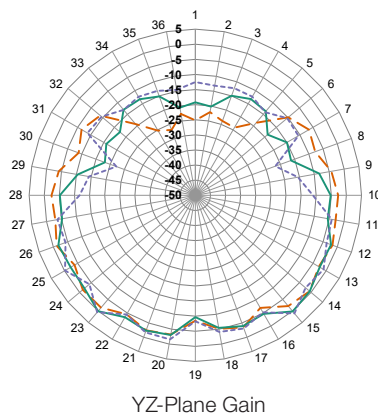
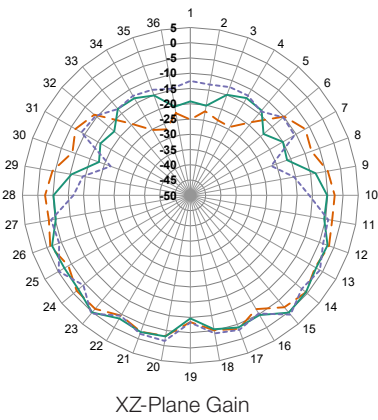

1710 MHz to 2200 MHz (1960 MHz)

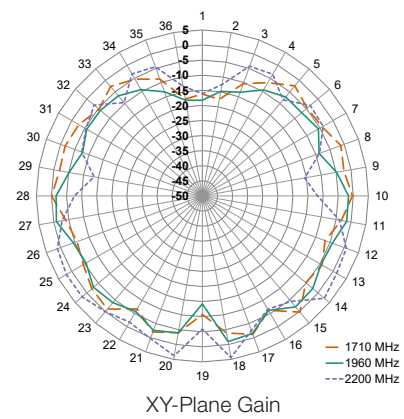
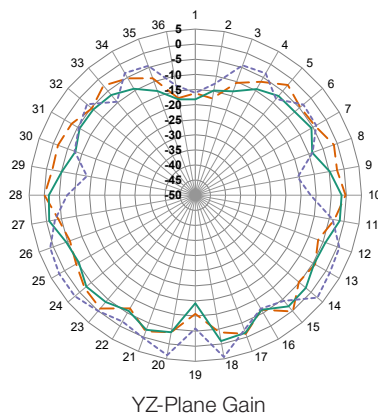
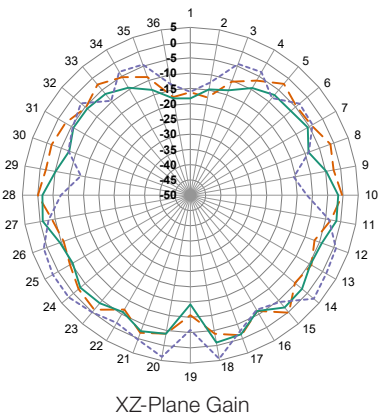

2300 MHz to 2400 MHz (2350 MHz)

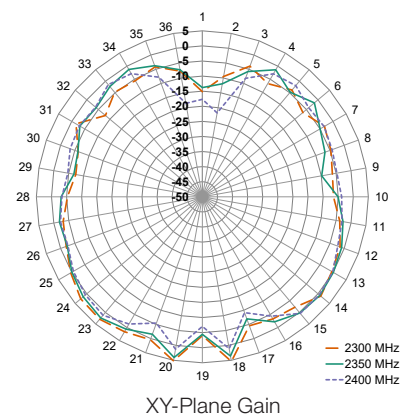
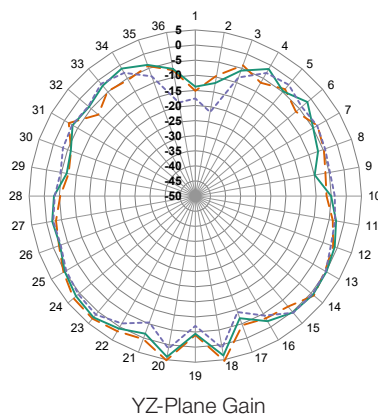
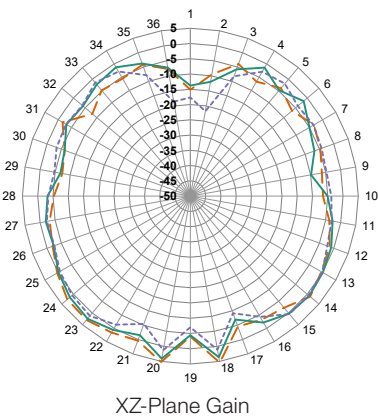

Radiation Patterns - Straight

2496 MHz to 2690 MHz (2600 MHz)

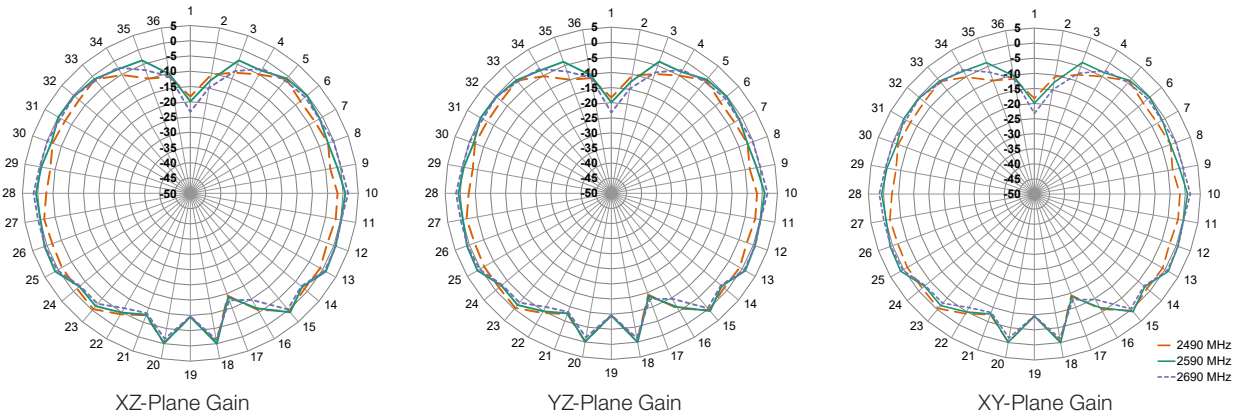

3300 MHz to 3800 MHz (3550 MHz)

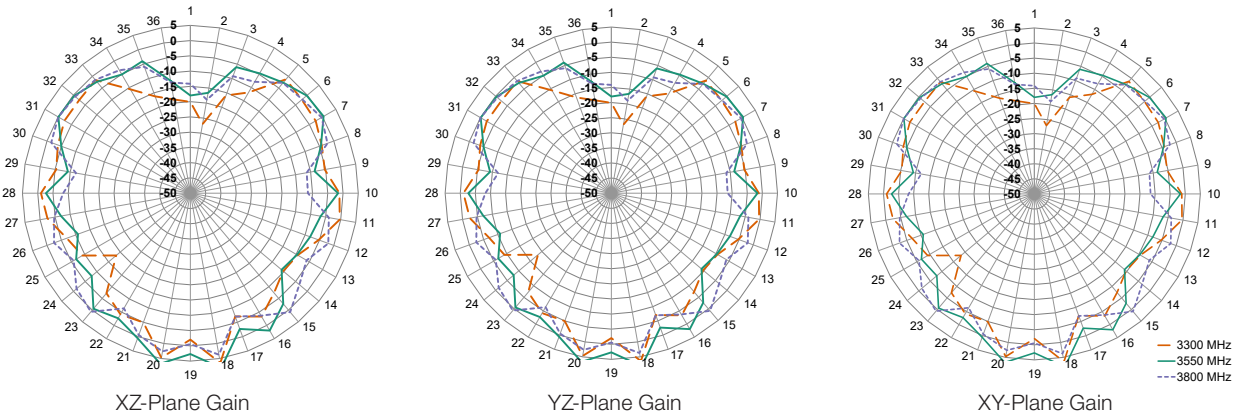

3550 MHz to 3700 MHz (3630 MHz)

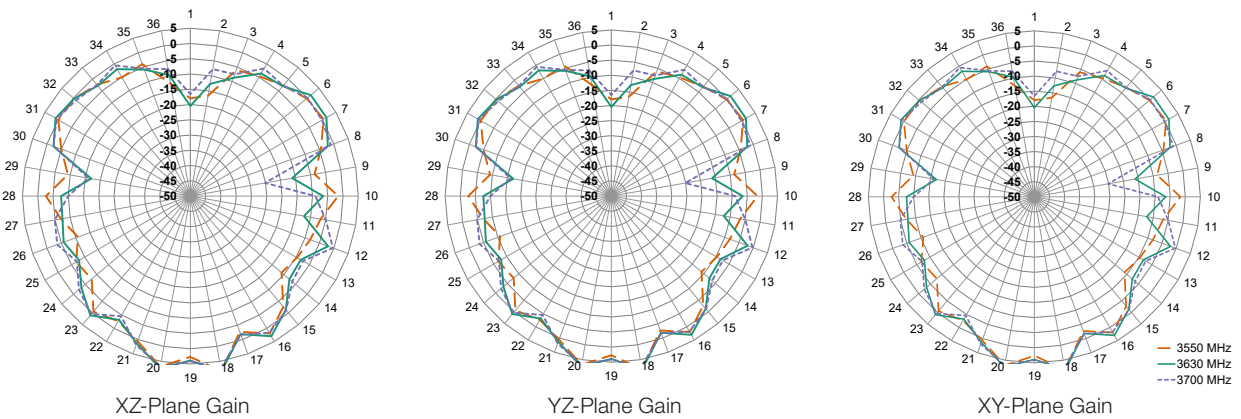

Radiation Patterns - Straight

3700 MHz to 4200 MHz (3950 MHz)

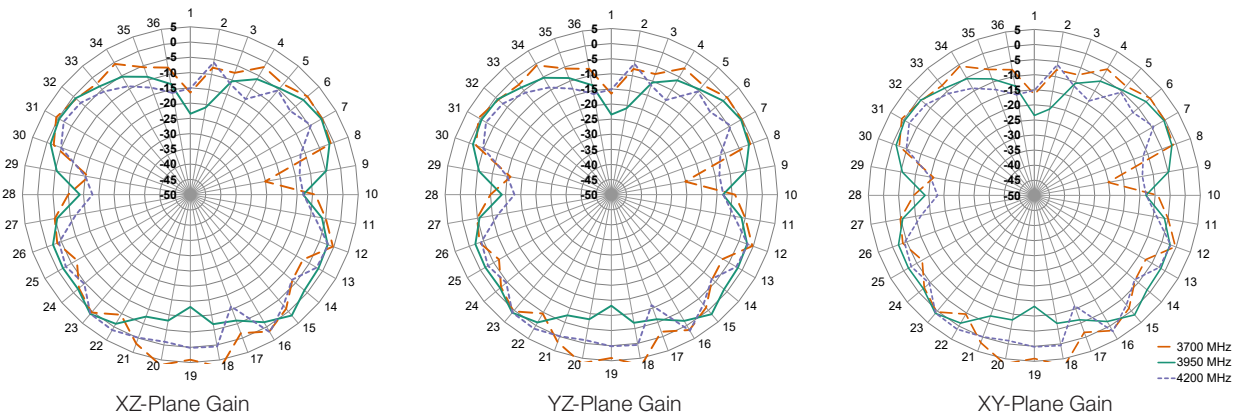

4400 MHz to 5000 MHz (4700 MHz)

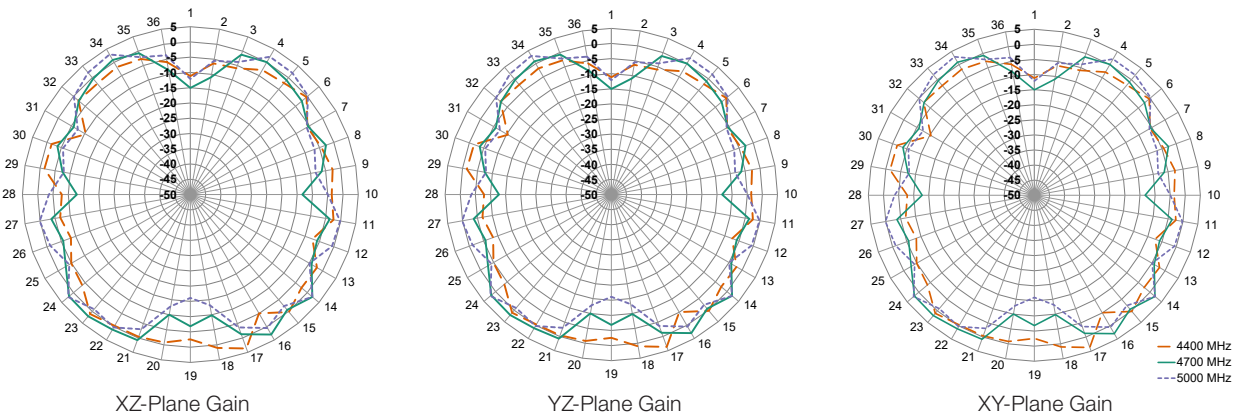

Figure 16. Radiation Patterns for ANT-5GWWS4-ccc, Straight

Website: <http://linxtechnologies.com>
Linx Offices: 159 Ort Lane, Merlin, OR, US 97532
Phone: +1 (541) 471-6256
E-MAIL: info@linxtechnologies.com

Linx Technologies reserves the right to make changes to the product(s) or information contained herein without notice. No liability is assumed as a result of their use or application. No rights under any patent accompany the sale of any such product(s) or information.

Wireless Made Simple is a registered trademark of Linx Acquisitions LLC. Other product and brand names may be trademarks or registered trademarks of their respective owners.

Copyright © 2021 Linx Technologies

All Rights Reserved

Doc# DS21344-169ANT Replaces (DS21314-169ANT)

