



DVI-I, DISPORT PORT, HDMI INTERFACE CONTROLLER FOR TFT PANEL

Model: HX-1920-PRO

Part number : 4177301XX-3 or up

INSTRUCTIONS

CONTENTS

Page:	2. Introduction, How to Proceed, Usage Note, Disclaimer
	3. System design – Diagram of a suggested system
	4. Assembly notes – Important information about system elements
	6. Connection & Operation – How to use the controller
	10. Connectors, pinouts & jumpers – Essential connection information
	23. Controller dimensions
	24. Application notes
	26. Troubleshooting
	27. Specifications
	28. Appendix I – Supported graphics modes table
	31. Appendix II – RS-232 control protocols
	38. Appendix III – Mapping definition
	41. Appendix IV – Auto Color Gain
	42. Appendix V – DV remote control unit work for HX-1920-PRO
	43. Appendix VI – PIP mix table
	44. Appendix VII – Light Sensor Function work for HX-1920-PRO
	45. Warranty, Caution & Limitation of Liability, Trademarks
	46. Contact details
	47. Revision History

It is essential that these instructions are read and understood before connecting or powering up this controller.

Introduction

Designed for LCD monitor and other flat panel display applications, the HX-1920-PRO is a feature rich interface controller for :

- TFT (active matrix) LCD panels of 1920x1200, 1920x1080, 1920x480, 1680x1050, 1600x1200, 1600x900, 1440x900, 1366x768, 1280x1024, 1280x800, 1280x768 1024x768, 1024x600, 800x600, 800x480 and 640x480 resolutions.
- Computer video signals of VGA, SVGA, XGA, SXGA, WXGA, UXGA, WUXGA standard.
- Support true 10 bits panel
- Support HDMI, DVI-I, Displayport input.
- Low mass tantalum capacitors for maximum vibration and shock tolerance, conformal coating, operating temperature range from -40°C to +80°C plus calculated MTBF in excess of 100K hours.
- Overall suitability for usage in critical applications must be independently tested and verified by the user.

Ordering information :

Controller	Part number	Ordering part number
HX-1920-PRO	P/N 41773012X-3	P/N 4177301XX-3

HOW TO PROCEED

- Ensure you have all parts & that they are correct, refer to:
 - Connection diagram

Controller Solution Generator

Full web resource matching controllers & panels with **connection diagrams** for download.
See at : <http://www.digitalview.com/csg>

- Connector reference (in following section)
- Assembly notes
- Check controller switch & jumper settings (errors may damage the panel)
- Prepare the PC
- Connect the parts
- Understand the operation & functions

IMPORTANT USAGE NOTE

This equipment is for use by developers and integrators, the manufacturer accepts no liability for damage or injury caused by the use of this product. It is the responsibility of the developer, integrators or other user of this product to:

- Ensure that all necessary and appropriate safety measures are taken.
- Obtain suitable regulatory approvals as may be required.
- **Check power settings to all component parts before connection.**

DISCLAIMER

There is no implied or expressed warranty regarding this material.

SYSTEM DESIGN

A typical LCD based display system utilizing this controller is likely to comprise the following:

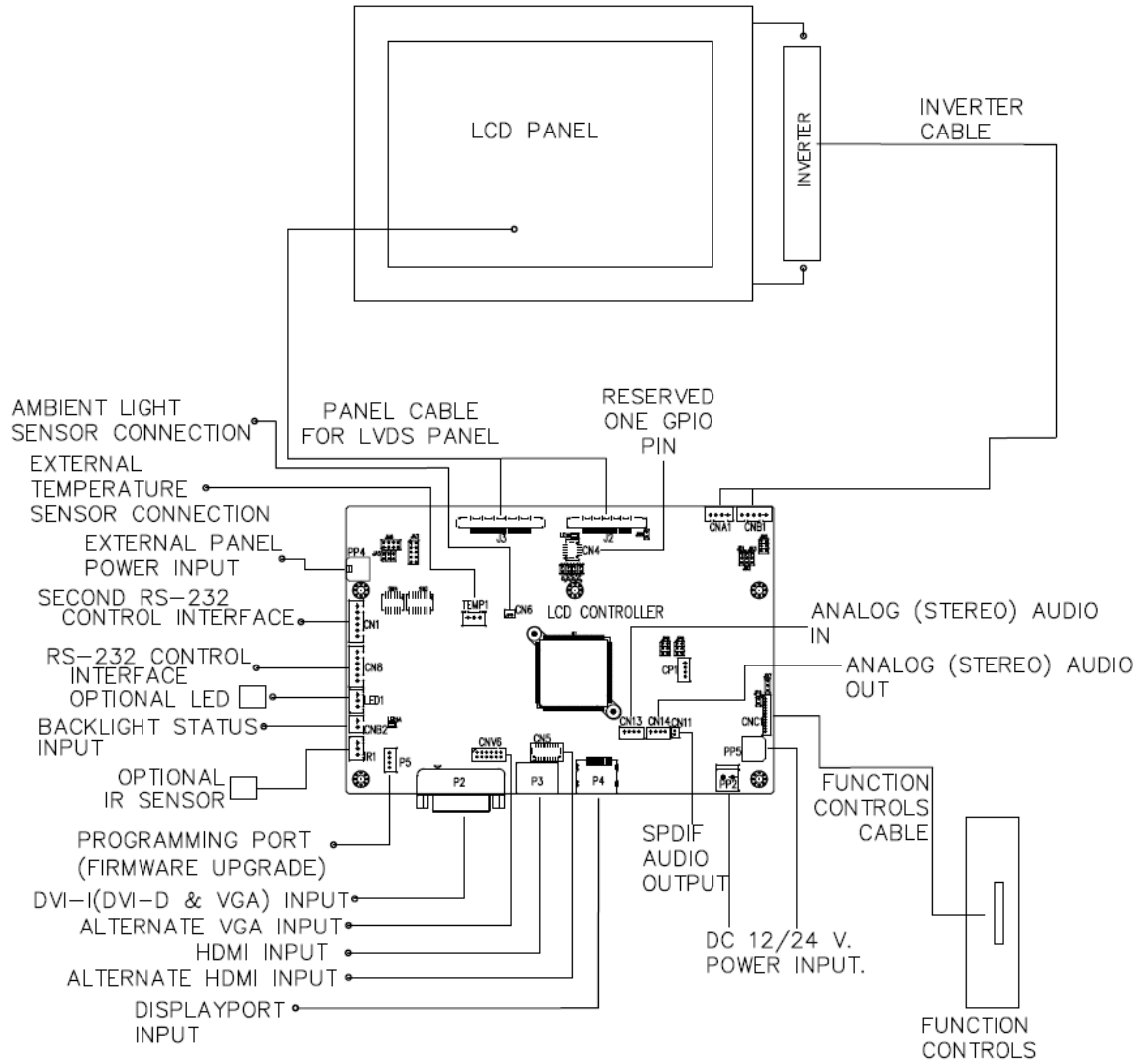

ASSEMBLY NOTES

This controller is designed for monitor and custom display projects using 1920x1200 or 1920x1080 or 1600x1200 or 1680x1050 or 1440x900 or 1366x768 or 1280 x 1024 or 1024 x 768 or 800x600 or 640x480 resolution TFT panels with a VGA, SVGA, WXGA, XGA, SXGA, UXGA or WUXGA signal input. The following provides some guidelines for installation and preparation of a finished display solution.

Preparation: Before proceeding it is important to familiarize yourself with the parts making up the system and the various connectors, mounting holes and general layout of the controller. As much as possible connectors have been labeled. Guides to connectors and mounting holes are shown in the following relevant sections.

1. **LCD Panel:** This controller is designed for typical LVDS interfaced panels with panel voltage 3.3V(4A), 5V(4A), 10v(4A) 12V(4A) or 18V(3A), External for 12V~18V interface. Due to the variation between manufacturers of panels signal timing and other panel characteristics, factory setup and confirmation should be obtained before connecting to a panel. **(NOTE: Check panel power jumper settings before connection)**
2. **Controller:** Handle the controller with care as static charge may damage electronic components. Make sure correct jumper and dip switches settings to match the target LCD panel.
3. **LCD signal cable (LVDS panel):** In order to provide a clean signal it is recommended that LVDS signal cables are no longer than 46cm (18 inches). If those wire cabling is utilized these can be made into a harness with cable ties. Care should be taken when placing the cables to avoid signal interference. Additionally it may be necessary in some systems to add ferrite cores to the cable to minimize signal noise.
4. **Inverter:** This will be required for the backlight of an LCD, some LCD panels have an inverter built in. As LCD panels may have 1 or more backlight tubes and the power requirements for different panel backlights may vary it is important to match the inverter in order to obtain optimum performance. See Application notes page 24 for more information on connection.
5. **Inverter Cables:** Different inverter models require different cables and different pin assignment. Make sure correct cable pin out to match inverter. Using wrong cable pin out may damage the inverter.
6. **Function Controls:** The following section discusses the controls required and the section on connectors provides the detail. The controls are minimal: On/Off, Backlight Brightness (depends on inverter), OSD (5 momentary buttons) analog VR type or (8 momentary buttons) digital type.
7. **Function controls cable:** The cables to the function switches should be of suitable quality and length so that impedance does not affect performance. Generally lengths up to 1 meter (3 feet) should be acceptable.
8. **Status LED:** The pin direction of the LED should be corrected for right color indication. Red color stands for no signal and backlight on. Orange color stands for no signal and backlight off. Green colors stands for signal on. The status LED is an optional part only, can be unconnected.
9. **IR sensor:** It is an optional part only, can be unconnected if not using IR remote control. See Appendix IV in details.
10. **RS-232 control interface :** Serial control via this interface port.
11. **Second RS-232 control interface :** Secondary serial control via this interface port.
12. **External panel power output :** User for specific panel model.
13. **Panel control signal :** Reserved for GPIO control for NVIS application
14. **Ambient light sensor connection :** Support for connection using light sensor cable P/N 426305900-3 (1250mm) and light sensor board P/N 416021310-3 via CN6 connector.
15. **Backlight status input :** 2 ways connector provides interface for connection with the specific panel type which support the panel with backlight status monitoring function.
16. **DVI-I input cable :** Plug the DVI-I cable to the connector P2 on the controller board providing VGA and DVI-D inputs.
17. **HDMI input :** Support HDMI 1.4 standard. Plug the HDMI cable to the connector P3 on the controller board.
18. **Alternate HDMI input :** This port (CN5) gives alternate HDMI 1.4 input support. This port is not support when P3 connector is connected.
19. **Analog RGB Input :** As this may affect regulatory emission test results and the quality of the signal to the controller a suitably shielded cable should be utilized.
20. **Display Port input :** Support single-link Display Port 1.2. Plug the Display Port cable to the connector P4 on the controller board.
21. **Audio Line in (Stereo) :** The CN13 port supports Stereo audio line in.

Specifications subject to change without notice

- 22. Audio Line out (Stereo) output from HDMI or Displayport :** The CN14 port supports Stereo audio line out from the HDMI or Displayport audio source inputted. The audio output will follow the HDMI audio source.
- 23. Power Input:** 12V/24VDC is required, this should be a regulated supply. The power rating is depending on the panel and inverter used. Normally, power supply with 3.5Amp current output should be enough for most of 4x CCFT panels. Although the controller provides power regulation for the LCD power this does not relate to the power supplied to the backlight inverter. If an unregulated power supply is provided to an inverter any fluctuations in power may affect operation, performance and lifetime of the inverter and or backlight tubes.
- 24. External panel power input :** Allow to supply external power to the panel separately for max 3.3V (7A) or 5V (7A) or 12V (5A) or 18V (3.5A) via PP4 power input connector. Corresponding jumper setting of JA3, JA5 & JA6 are required for each panel power input by referring to page 13.
- **Power output:** Note the controller has an overall 3Amp current limit and the current available from the auxiliary power output will be dependent on the power input and other system requirements.
 - **Power Safety:** Note that although only 12V / 24VDC is required as 'power-in' a backlight inverter for panel backlighting produces significantly higher voltages (the inverter does not connect to the ground plane). We strongly advise appropriate insulation for all circuitry.
 - **EMI:** Shielding will be required for passing certain regulatory emissions tests. Also the choice of external Controller to PC signal cable can affect the result.
 - **Ground:** The various PCB mounting holes are connected to the ground plane.
 - **Servicing:** The board is not user serviceable or repairable. Warranty does not cover user error in connecting up to the controller and is invalidated by unauthorized modification or repairs.
 - **Controller Mounting:** It is recommended that a clearance of at least 10mm is provided above and 5mm below the controller when mounted. Additionally consideration should be given to:
 - Electrical insulation.
 - Grounding.
 - EMI shielding.
 - Cable management. Note: It is important to keep panel signal cables apart from the inverter & backlight cables to prevent signal interference.
 - Heat & Ventilation: Heat generated from other sources, for example the backlight of a very high brightness panel may generate significant heat which could adversely affect the controller.
 - Other issues that may affect safety or performance.
 - **PC Graphics Output:** A few guidelines:
 - Signal quality is very important, if there is noise or instability in the PC graphics output this may result in visible noise on the display.
 - Refer to graphics modes table in specifications section for supported modes.
 - Non-interlaced & interlaced video input is acceptable.

IMPORTANT: Please read the Application Notes section for more information.

CONNECTION & OPERATION

CAUTION: Never connect or disconnect parts of the display system when the system is powered up as this may cause serious damage.

CONNECTION

Connection and usage is quite straight forward (it is useful to have the relevant connection diagram available at this time):

- LCD panel & Inverter:** Connect the inverter (if it is not built-in the panel) to the CCFT lead connector of the LCD panel.
- LVDS type panels:** The controller board has the built-in LVDS transmitter driver. Plug the LVDS cable to J3. Insert the panel end of the cable the LCD panel connector.
- Inverter & Controller:** Plug the inverter cable to CNB1 and CNA1 (if necessary). Plug another end to the connector on the inverter.
- Function switch & Controller:** Plug the OSD switch mount cable to CNC1 on the controller board and another to the OSD switch mount.
- LED & Controller:** Plug in a 3-way with dual color LED to connector LED1 on the controller board.
- IR & Controller:** Plug in a 3-way with IR sensor to connector IR1 on the controller board.
- Jumpers & Switches:** Check all jumpers and switches (SW3, SW4) are set correctly. Details referring the connection diagram (a separate document) or the jumpers and switches setting table (in the following section).
- Jumpers & Inverter & Panel voltage:** Particularly pay attention to the settings of JA3, JA5, JA6, JB2 and JB3. JB2 & JB3 are used for inverter control (read inverter specification and information on the jumper table to define the correct settings). JA3 & JA5 & JA6 is used for panel voltage input (read panel specification and information on the jumper table to define the correct settings).
- Input signal cable & Controller:** Plug the corresponding signal input to the connector on the controller board.
- Power supply & Controller:** Plug the DC 12V/24V power in to the connector PP5 or PP2. You can consider to use DigitalView mating power cable P/N 426013800-3, 160mm for PP5 connection.
- External panel power input :** Plug power cable : P/N 426013700-3 for external panel power input (3.3 (max 7A) / 5V (max 7A) / 12V (max 5A) / 18V (max3.5))
- Power on:** Switch on the controller board and panel by using the OSD switch mount.

Controller LED status (LED1/LED1A) :

State	LED color
No signal & backlight off	RED
No signal & backlight on	ORANGE
With signal & backlight on	GREEN

Controller LED status (LED6) :

Panel power output status	LED color
10V / 12V / 18V panel power output	GREEN
3.3V / 5V panel power output	RED

General:

- If you are using supplied cables & accessories, ensure they are correct for the model of panel and controller.
- If you are making your own cables & connectors refer carefully to both the panel & inverter specifications and the section in this manual, "Connectors, Pinouts & Jumpers" to ensure the correct pin to pin wiring.

PC SETTINGS

The controller has been designed to take a very wide range of input signals however to optimize the PC's graphics performance we recommend choosing 60Hz vertical refresh rate – this will not cause screen flicker.

OPERATION

Once the system has been connected and switched on there are a number of functions available to adjust the display image as summarized in the following sections. The settings chosen will be saved for each mode independently.

LCD DISPLAY SYSTEM SETTINGS

NOTE: By way of explanation the following refers to a set of sample buttons that may be obtained as an option. In addition to power on/off and connection for backlight brightness the controller provides an On Screen Display of certain functions which are controlled by 5 momentary type buttons (analog VR type) or 8 momentary type buttons (digital type):

Controls	Digital type	5 button OSD switch mount board
On/Off – turns controller board power on	On/Off button	-
Brightness – controls backlight brightness	Brightness +/- buttons	-
Menu – Turns OSD menu On or Off (it will auto time off)	Menu button	Menu button
Select down – Moves the selector to the next function (down)	SEL DN	SEL DN
Select up – Moves the selector to the previous function (up)	SEL UP	SEL UP
+ – Increase the OSD parameter values – Moves the selector to next function (forward)	+	+
- – Decrease the OSD parameter value – Moves the selector to previous function (backward)	-	-
Reset to Factory Defaults	Press and hold SEL DN button, then power on the controller	Press and hold SEL DN button, then power on the controller
Soft power off and on	Hold Menu button for 3-4 seconds. Press Menu button to turn back on.	Hold Menu button for 3-4 seconds. Press Menu button to turn back on.

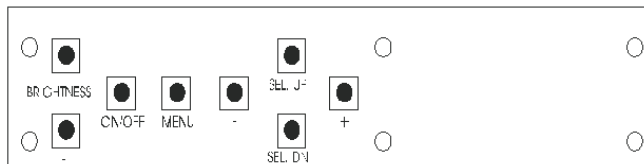

Digital type





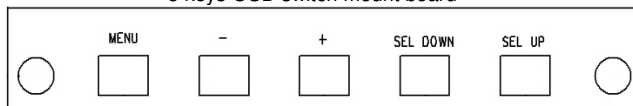





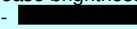

Digital 10K Type OSD switch mount
P/N 416100520-3 or up,
matching cable P/N
426122200-3.

5 keys OSD switch mount board

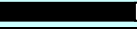

5 buttons OSD switch mount board P/N 4161003700-3,
matching cable
P/N 426123010-3.

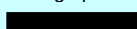
OSD functions

Picture	
Black Level	Increase/decrease brightness level. Press – or + (-  +) 0~100 [Default : 50]
Contrast	Increase/decrease contrast level. Press – or + (-  +) 0~100 [Default : 50]
Sharpness	Increase/decrease sharpness level. Press – or + (-  +) 0~100 [Default : 50]
Hue	Increase/decrease hue level. Press – or + (-  +) 0~100 [Default : 50]
Saturation	Increase/decrease saturation level. Press – or + (-  +) 0~100 [Default : 50]
Gamma	1.8 / 2.0 / 2.2 / 2.4 / 2.6 [Default 2.2]
Monochrome Mode	Off Blue Only Red Only Green Only Blue Mono Red Mono Green Mono
Color Temp.	5000K 6500K 7500K [Default] 9300K User Red : Press – or + (-  +) 0~100 [Default : 100] Green : Press – or + (-  +) 0~100 [Default : 100] Blue : Press – or + (-  +) 0~100 [Default : 100]
Brightness	
Brightness	Backlight brightness adjustment Press – or + (-  +) 0~100
Invert	Off / On : Invert for the backlight brightness
Control	D/A / PWM : Selection for voltage level dimming control / PWM dimming control
Frequency(Hz)	Backlight frequency 100 ~ 440Hz in a step of 20 Press – or + (-  +)
Minimum	Min Backlight Level : 0 ~ 50% : Default the minimum backlight adjustment.
Light sensor	Off / On
Display	
Rotate	Normal 90° 180° 270° H Flip V Flip
Aspect/Size	Full Screen : Scaling format to Fill Screen.[Default] Fill to Aspect Ratio : Enable fill screen expansion for lower resolution image according to aspect ratio 4:3 : Scaling format to 4:3 5:4 : Scaling format to 5:4 16:9 : Scaling format to 16:9 1:1 : Display the exact image resolution on the screen without image expansion.
Horizontal Position[#]	Use +/- to adjust image position horizontally. Press – or + (-  +) 0~100
Vertical Position[#]	Use +/- to adjust image position vertically. Press – or + (-  +) 0~100
Pixel Clock[#]	Adjust the image horizontal size. Press – or + (-  +) 0~100
Phase[#]	Fine tune the data sampling position (adjust image quality) Press – or + (-  +) 0~100
Auto Adjust[#]	Auto adjust the positions, phase, frequency

Specifications subject to change without notice

Input		
	Main Source	VGA DVI HDMI DisplayPort Auto Select : Enable / Disable the Auto source seek function
	PIP Source	VGA DVI HDMI DisplayPort Auto Select : Enable / Disable the Auto source seek function
PIP		
	Mode	Off PIP PBP
	PIP Size	Adjust the PIP size, total: 5 steps Press – or + (- <input type="text"/> +) 1~5 [Default : 1]
	PIP H-Position	Move the PIP position to the left/right position, total: 100 steps Press – or + (- <input type="text"/> +) 0~100 [Default : 0]
	PIP V-Position	Move the PIP position to the up/down position, total: 100 steps Press – or + (- <input type="text"/> +) 0~100 [Default : 0]
Audio		
(Function when HDMI and Display Port connected and selected)		
	Volume	Increase/decrease volume level, total: 100 steps Press – or + (- <input type="text"/> +) 0~100 [Default : 50]
	Mute	Off / On [Default: OFF]
Hotkey		
	Hotkey1	Volume / Black level / Contrast / Inputs / Aspect/Size / PIP Size / PIP ON/OFF / Saturation / Hue / Brightness / Auto Adjust / Rotate / No Function
	Hotkey2	Volume / Black level / Contrast / Inputs / Aspect/Size / PIP Size / PIP ON/OFF / Saturation / Hue / Brightness / Auto Adjust / Rotate / No Function
Utilities		
	Language	OSD menu language selection : English French Spanish
	Auto Power	Off : Disable standby mode function On : Enable standby mode if absence of input signals.
	Default Power State	Off : When the controller detects power in, it will stay in 'Stand-by' mode. On : When the controller detects power in, it will turn on the power and display
	OSD Transparency	Transparency : Set OSD transparency Press – or + (- <input type="text"/> +) 0~100 [Default : 0]
	OSD Timeout	Timer : OSD Timeout in seconds Press – or + (- <input type="text"/> +) 5~60 [Default : 15]
	Factory Reset	Reset : Load factory default settings. Press down on OSD keypad to factory reset
	Firmware Upgrade	Are you sure to upgrade ? No / Yes.
Information		
	Model : SVX-1920-PRO Firmware version Main resolution Pip resolution	

Function in VGA mode only

Firmware V1.11.00.00 or up

CONNECTORS, PINOUTS & JUMPERS

The various connectors are:

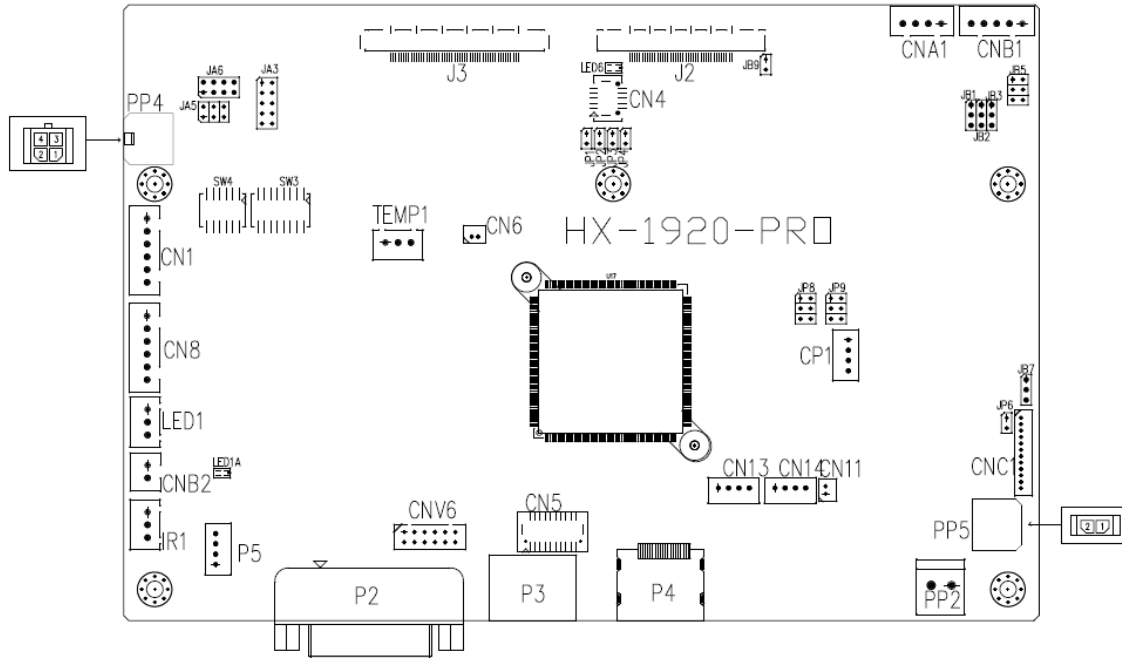

Summary: Connectors

Ref	Purpose	Description
CN1	Reserved for second RS-232 serial control	JST 6-way, B6B-XH-A or compatible (Matching type : XHP-6 or compatible) (Matching cable with DB9 female connector P/N 426090200-3) (Matching cable with DB9 male connector P/N 426090400-3)
CN4	Panel control signal (GPIO) connector	Hirose 10-pin, DF20G-10DP-1V (Matching type : DF20A-10DS-1C)
CN5	Alternate HDMI connector	JST BM20B-SRDS (Matching type : SHDR-20V-S-B) (Matching extend cable with female HDMI connector : P/N 426301800-3) (Matching extend cable with male HDMI connector : P/N 426006600-3)
CN6	Ambient light sensor connector	DF13 2 ways (Mating type : DF13-2S-1.25C)
CN8	RS-232 serial control	JST 6-way, B6B-XH-A or compatible (Matching type : XHP-6) (Matching cable with DB9 female connector P/N 426090200-3) (Matching cable with DB9 male connector P/N 426090400-3)
CN11	SPDIF Audio output	JST B2B-ZR or compatible (Matching type : ZHR-2) (Matching extend cable P/N 426007400-3)
CN13	Analog (Stereo) audio in	JST B4B-PH-K-S compatible (Matching type : PHR-4) (Matching connection cable P/N 426002500-3 (RCA plug, 610mm) or P/N 426002600-3 (RCA jack, 150mm))
CN14	Analog (Stereo) audio out	JST B4B-PH-K-S compatible (Matching type : PHR-4) (Matching connection cable P/N 426002500-3 (RCA plug, 610mm) or P/N 426002600-3 (RCA jack, 150mm))
CNA1	Auxiliary power output	JST 4-way, B4B-XH-A or compatible (Matching type : XHP-4) (Matching cable P/N 426040200-3)
CNB1	Backlight inverter	JST 5-way, B5B-XH-A or compatible (Matching type : XHP-5) (Matching cable P/N 426058300-3)
CNB2	Backlight status input connector	JST 2 way, B2B-XH-A or compatible (Matching type : XHP-2)
CNC1	OSD control	Hirose DF13A-12P-1.25H (Mating type : DF13-12S-1.25C) (For 8 buttons OSD switch mount (P/N 416100520-3): Matching OSD switch mount cable P/N 426122200-3 (150mm) or 426122210-3 (250mm) (For 5 buttons OSD switch mount (P/N 416103700-3) : Matching OSD switch mount cable P/N 426123010-3)

Specifications subject to change without notice



CNV6	Alternate VGA input	Hirose 12-pin, DF11-12DP-2DSA compatible (Matching type : DF11-12DS-2C) (Matching cable Modified P/N 426003300-3 by removing by disconnecting pin 10 and pin 12 connected to CNV6)
CP1	Reserved for factory use	Reserved
IR1	Infra-red sensor connector	JST 3-way, B3B-XH-A or compatible (Matching type : XHP-3)
LED1	Dual color LED connector	JST B3B-XH-A or compatible (Matching type : XHP-3)
J2	LVDS panel signal output 1	JAE FI-RE41S-HF (Matching type : FI-RE41HL)
J3	LVDS panel signal output 2	JAE FI-RE51S-HF (Matching type : FI-RE51HL)
P2	DVI-I	DVI-I connector
P3	HDMI signal input (HDMI 1.4)	HDMI connector
P4	Displayport	Display port connector
P5	Connector for firmware upgrade	JST B4B-PH-K compatible (Matching type : PHR-4) (Matching USB extend cable P/N 426895100-3)
PP2	Power input (alternative)	DC power Molex 2 pin 0.156" pitch
PP4	External panel power input	Molex 43045-0400 compatible (Matching connector type : Molex 43025-0400 compatible) (Matching power cable : P/N 426013700-3)
PP5	Power input	Molex 43650-0200 compatible (Matching connector type : Molex 43645-0200 compatible) (Matching power cable : P/N 426013800-3)
TEMP1	Reserved for external temperature sensor	JST 3-way, B3B-XH-A or compatible (Matching type : XHP-3)
SW3	Panel selection	8-way DIP Switch
SW4	Function selection	6-way DIP Switch

All connectors used may use the compatible type.

Summary: Jumpers setting

Ref	Purpose	Note
JA3	Panel power voltage select CAUTION: Incorrect setting can damage panel	See panel voltage setting table 1
JA5	Panel power voltage select CAUTION: Incorrect setting will cause panel damage	See panel voltage setting table 1
JA6	Panel power voltage select CAUTION: Incorrect setting will cause panel damage	See panel voltage setting table 1
JB1	Backlight brightness voltage range	1-2 closed = 5V max 2-3 closed = 3.3V max
JB2	Backlight inverter on/off control – signal level	2-3 = On/Off control signal 'High' = +5V 1-2 = On/Off control signal 'High' = +3.3V Open = On/Off control signal 'High' = Open collector CAUTION: Incorrect setting can damage inverter.
JB3	Backlight inverter on/off control – polarity	1-2 = control signal 'high' = CCFT ON 2-3 = control signal 'low' = CCFT ON
JB5	Backlight control type selection	1-2 = VR/Digital switch mount control 3-4 = Analog backlight brightness - voltage range 0~5V 5-6 = PWM (Pulse Width Modulation) brightness
JB7	Backlight control voltage on CNB1 pin 4 (Function when JB5 sets 1-2 closed)	Open = For OSD switch mount control (Default) 1-2 = 0V 2-3 = 3.3V / 5V controlled by JB1
JP1	GPIO pins enable	Open : Enable J3 – pin 16 (OP1) to 3.3V Closed : Enable J3 – pin 16 (OP1) to Ground
JP2	GPIO pins enable	Open : Enable J3 – pin 17 (OP2) to 3.3V Closed : Enable J3 – pin 17 (OP2) to Ground
JP3	GPIO pins enable	Open : Enable J3 – pin 18 (OP3) to 3.3V Closed : Enable J3 – pin 18 (OP3) to Ground
JP4	GPIO pins enable	Open : Enable J3 – pin 19 (OP4) to 3.3V Closed : Enable J3 – pin 19 (OP4) to Ground
JP6	Input power control	Short = External switch control Open = Switch mount control
JP8	Factory use	Default 1-3 & 2-4
JP9	Factory use	Default Open
SW3	Panel & function selection	See table 2
SW4	Panel & function selection	See table 3

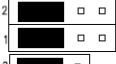
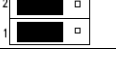
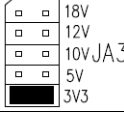
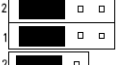
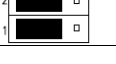
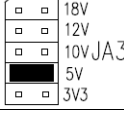
Table 1 : Panel voltage setting table :

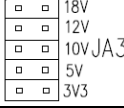
Input voltage via PP2/PP5	Panel Voltage	JA3	JA5	JA6	Jumper on board
12VDC	3.3V	3V3 closed	1-3 & 2-4	1-3 & 2-4	  
	5V	5V closed	1-3 & 2-4	1-3 & 2-4	  
	12V	OPEN	1-3 & 2-4	5-7 & 6-8	  

CAUTION: Incorrect setting can damage panel & controller

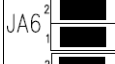
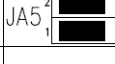
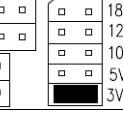
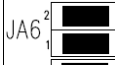
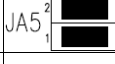
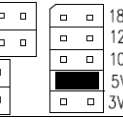
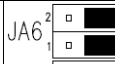
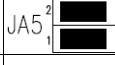
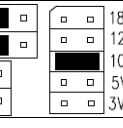
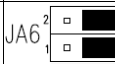
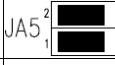
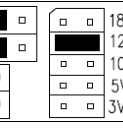
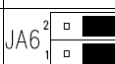
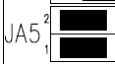
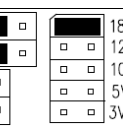

* Maximum current for 3.3V, 5V = 4A,

Input voltage via PP2, PP5	Panel Voltage	JA3	JA5	JA6	Jumper on board
24VDC**	3.3V	3V3 closed	1-3 & 2-4	1-3 & 2-4	  
	5V	5V closed	1-3 & 2-4	1-3 & 2-4	  
	10V	10V closed	1-3 & 2-4	3-5 & 4-6	  
	12V	12V closed	1-3 & 2-4	3-5 & 4-6	  
	18V	18V closed	1-3 & 2-4	3-5 & 4-6	  

CAUTION: Incorrect setting can damage panel & controller

* Maximum current for 3.3V, 5V = 4A, Maximum current for 10V,12V = 4A, Maximum current for 18V = 3A

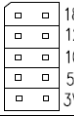
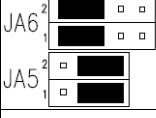
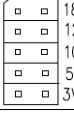
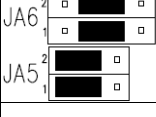
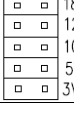
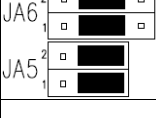
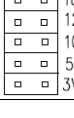
**** Ensure that the backlight inverter supports 24V operation prior to connecting a 24VDC input. Because CNA1 pin 1 and CNB1 pin 2 will output 24VDC if input 24VDC via PP2 or PP5.**

Input voltage via PP4	Input voltage via PP2 / PP5	Panel Voltage	JA3	JA5	JA6	Jumper on board
3.3 / 5 / 12 / 18VDC*	12V / 24VDC	3.3V	OPEN	3-5 & 4-6	1-3 & 2-4	 
		5V	OPEN	3-5 & 4-6	1-3 & 2-4	 
		10V	OPEN	3-5 & 4-6	3-5 & 4-6	 
		12V	OPEN	3-5 & 4-6	3-5 & 4-6	 
		18V	OPEN	3-5 & 4-6	3-5 & 4-6	 

* Maximum current for 3.3V, 5V = 7A, Maximum current for 12V = 5A, Maximum current for 18V = 3.5A

JA3, JA5 & JA6 location on board : (Please pay attention to the jumper settings on JA3, JA5 & JA6 which are red in color)

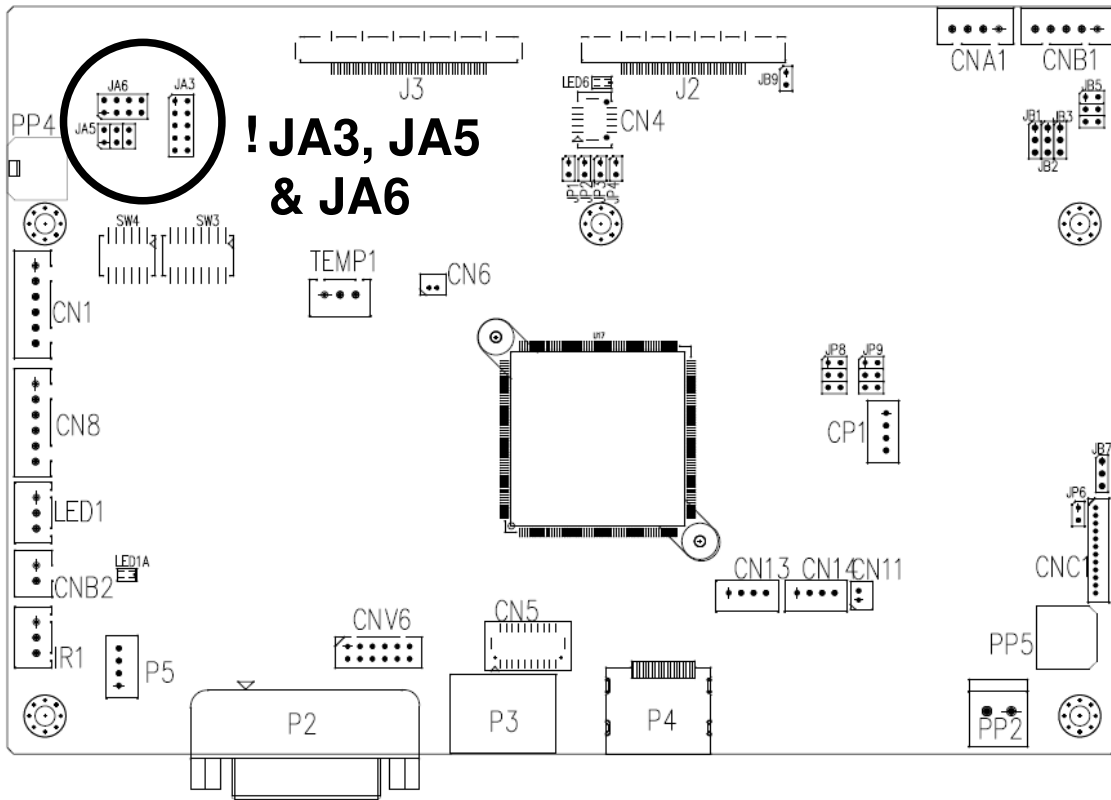

Table 2 : DIP Switch selection – SW3

Pos #1	Pos #2	Pos #3	Pos.#4	Description	Panel resolution
For WUXGA panels					
OFF	ON	ON	OFF	LG LM260WU1-SLB1/Samsung LTM220CS01	1920x1200
ON	ON	ON	OFF	LG LM240WU2-SLA1	1920x1200
OFF	OFF	OFF	OFF	Sharp LQ445D3LZ19	1920x1080
ON	OFF	OFF	OFF	Samsung LTA460H2-L02	1920x1080
OFF	ON	OFF	OFF	Sharp LQ170M1LZ04	1920x1200
ON	ON	OFF	OFF	Samsung LTA700HH-LH1 (1 st trial testing)	1920x1080
OFF	OFF	ON	OFF	Samsung LTA700HH-LH1 (2 nd trial testing)	1920x1080
OFF	OFF	ON	ON	AU Optronics P645HW03 V0 (1920x1080)	1920x1080
OFF	OFF	ON	ON	AU Optronics P645HW03 V0	1920x1080
OFF	ON	ON	ON	Samsung ASI545FB01-0 (OLED)	1920x1080
For UXGA panels					
OFF	OFF	OFF	OFF	Fujitsu FLC59UXC8V-02A	1600x1200
ON	OFF	OFF	OFF	Samsung LTM213U6-L01	1600x1200
For WXGA panels					
OFF	OFF	OFF	OFF	LG LC420W02-A4	1366x768
ON	OFF	OFF	OFF	Sharp LQ315T3LZ24	1366x768
ON	ON	OFF	OFF	Samsung LTA320W2-L01 / LTA230W1-L02	1366x768
ON	ON	ON	ON	NEC NL12876BC26-21 / Samsung LTM170W1-L01	1280x768
OFF	ON	ON	ON	CHI MEI N15414-L01	1280x800
OFF	OFF	ON	OFF	AU Optronics M190PW01	1440x900
OFF	OFF	ON	ON	Sharp LQ072K1LA03	1280x768
For SXGA panel					
OFF	OFF	OFF	OFF	Sharp LQ181E1LW31	1280x1024
ON	OFF	OFF	OFF	AU Optronics M170EN05	1280x1024
For XGA panel					
OFF	OFF	OFF	OFF	Sharp LQ150X1LGN2A / LQ150X1LGB1	1024x768
				AUO M150XN07V2	1024x768
For SVGA panel					
OFF	OFF	OFF	OFF	Sharp LQ121S1DG11/41	800x600
				Toshiba LTM08C351	800x600
For WVGA panel					
OFF	OFF	OFF	OFF	NEC NL8048BC24-01	800x480
ON	OFF	OFF	OFF	Kyocera TCG085WV1AB-G00	800x480
ON	OFF	ON	OFF	Sharp LQ070Y3LG4A	800x480
For VGA panel					
OFF	OFF	OFF	OFF	Sharp LQ104V1DG51	640x480
ON	OFF	OFF	OFF	Sharp LQ104V1DG21	640x480
ON	OFF	ON	OFF	Kyocera TCG075VG2AC-G00	640x480
Others					
OFF	ON	OFF	OFF	AU Optronics M201EW02 V8	1680x1050
ON	OFF	OFF	ON	Samsung LTM201M1-L01	1680x1050
OFF	OFF	ON	OFF	Samsung LT1430LA01	1920x480
OFF	ON	ON	OFF	NEC NL10260BC19-01D	1024x600
ON	ON	ON	OFF	AU Optronics M200RW01	1600x900
				Samsung LTM200KP01	1600x900
OFF	OFF	ON	ON	Hitachi TX48D02VM0BAA	1680x1050
				JDI TX48D02VM0BAA	1680x1050

Remark : The above panel timings are generated based on the panel specification. Some of the panel timings settings may not exactly to match the panel model we specified in this table.

Pos #5	Pos #6	Pos #7	Description
OFF	OFF	OFF	WUXGA
ON	OFF	OFF	UXGA
OFF	ON	OFF	SXGA
ON	ON	OFF	WXGA
OFF	OFF	ON	XGA
ON	OFF	ON	SVGA
OFF	ON	ON	VGA
ON	ON	ON	WVGA / Others

Pos. #8	Video lock	ON – Disable : Always fix the output be 60Hz. OFF – Enable : The output refresh rate locks to the input for 50Hz / 60Hz mode (other resolution lock the output be 60Hz.)
---------	------------	--

Table 3 : DIP switch selection – SW4

Pos. #	Function	Description
1	Reserved	
2	Panel pixel format	OFF : Double Pixel ON : Single Pixel
3	Panel selection	ON : LVDS panel OFF : Reserved
4	LVDS data mapping select (Refer to Table 2)	If SW4 position 5 = OFF (8 bit) OFF : Mapping B ON : Mapping A Please adjust to get the correct picture. See as Appendix III for details of mapping of A and B. If SW4 position 5 = ON (10 bit) OFF : JEIDA (LVDS panel) ON : VESA (LVDS panel) Please adjust to get the correct picture. See as Appendix III for details of mapping of VESA and JEIDA.
5	Output LVDS display mode selection	OFF : 8 bit ON : 10 bit
6	Reserved	

Support "Resolution default by EDID" for different resolution panel.

The controller will set the preferred timing based off the dip switch setting (SW3 position 1-7) selection, but also be able to go higher to 1920x1200. For example, if the panel is a 1024x768 and the dip switch setting are set for 1024x768. The preferred EDID resolution should be 1024x768. It should also have the capability to set the max resolution to 1920x1200.

CN1 – Slave RS-232 serial control: JST B6B-XH-A (Matching type : XHP-6)

PIN	SYMBOL	DESCRIPTION
1	EXT_MSTR2_SCL	Reserved
2	EXT_MSTR2_SDA	Reserved
3	VCC	+5V
4	TXD	RS-232 Tx data
5	GND	Ground
6	RXD	RS-232 Rx data

CN4 – Panel connector: HIROSE DF20G-10DP-1V (Matching type : DF20A-10DS-1C)

PIN	SYMBOL	DESCRIPTION
1	OP1	Reserved
2	OP2	Reserved
3	OP3	Reserved
4	OP4	Reserved
5	IP1	Reserved
6	IP2	Reserved
7	IP3	Reserved
8	IP4	Reserved
9	EXT_MSTR2_SDA	Reserved
10	EXT_MSTR2_SCL	Reserved

CN5 - Alternate HDMI connector : JST BM20B-SRDS (Matching type : SHDR-20V-S-B)

PIN	SYMBOL	DESCRIPTION
1	GND	Ground
2	GND	Ground
3	RXC+	TMDS Data C+
4	RXC-	TMDS Data C-
5	RX0+	TMDS Data 0+
6	RX0-	TMDS Data 0-
7	RX1+	TMDS Data 1+
8	RX1-	TMDS Data 1-
9	RX2+	TMDS Data 2+
10	RX2-	TMDS Data 2-
11	GND	Ground
12	GND	Ground
13	MSTR2_SCL	Reserved
14	MSTR2_SDA	Reserved
15	DDC_5V	+5V power supply for DDC (optional)
16	HPD	Hot plug detection
17	DDC_SCL	DDC serial clock
18	DDC_SDA	DDC Data
19	CEC	Consumer Electronics Control(CEC) pin
20	VCC2	VCC 5V output

CN6 – Ambient light sensor connector : DF13 2 ways compatible (Matching type : DF13-2S-1.25C)

PIN	SYMBOL	DESCRIPTION
1	3.3V	3.3V
2	ALS	Ambient light sensing

CN8 – RS-232 serial control: JST B6B-XH-A (Matching type : XHP-6)

PIN	SYMBOL	DESCRIPTION
1	EXT_MSTR2_SCL	Reserved
2	EXT_MSTR2_SDA	Reserved
3	VCC	+5V
4	TXD	RS-232 Tx data
5	GND	Ground
6	RXD	RS-232 Rx data

CN11 – SPDIF audio output connector : JST B3B-PH-K (Matching type : PHR-3)

PIN	SYMBOL	DESCRIPTION
1	SPDIF	SPDIF Digital audio output
2	GND	Ground

CN13 –Audio line in (Stereo) connector: JST B4B-PH-K compatible (Matching type : PHR-4)

PIN	SYMBOL	DESCRIPTION
1	GND	GND
2	AUDIO LIN	AUDIO LINE IN LEFT
3	GND	GND
4	AUDIO RIN	AUDIO LINE IN RIGHT

CN14 –Audio line out (Stereo) connector: JST B4B-PH-K compatible (Matching type : PHR-4)

PIN	SYMBOL	DESCRIPTION
1	GND	GND
2	AUDIO LOUT	AUDIO LINE OUT LEFT
3	GND	GND
4	AUDIO ROUT	AUDIO LINE OUT LEFT

CNA1 - Auxiliary power output: JST B4B-XH-A (Matching type : XHP-4)

PIN	SYMBOL	DESCRIPTION
1	AUX 12V / 24V	+12V / +24V DC, 500mA max
2	GND	Ground
3	GND	Ground
4	AUX 5V	+5V DC, 500mA max

CNB1 – Backlight inverter connector: JST B5B-XH-A (Matching type : XHP-5)

PIN	SYMBOL	DESCRIPTION
1	GND	Ground
2	VBKL	+12V / +24V DC, backlight power supply
3	BLCTRL	On/Off control (enable) – see JB2 & JB3
4	BVR_WIP	Brightness VR – WIP
5	BVR_A	Brightness VR A

CNB2 – Backlight status input inverter connector: JST B2B-XH-A (Matching type : XHP-2)

PIN	SYMBOL	DESCRIPTION
1	BL_STATUS	Backlight status (Normal = High)
2	GND	Ground

CNC1 – OSD switch mount control, Hirose DF13A-12P-1.25H (Mating type : DF13-12S-1.25C)

PIN	SYMBOL	DESCRIPTION
1	PSWIN	Power button A
2	SW_ON	Power button B
3	BVR_A	Backlight Brightness VR pin A
4	BVR_WIP	Backlight Brightness R pin WIP
5	BVR_B	Backlight Brightness VR pin B (470 ohm resistor to +5V Vcc)
6	GND	Ground
7	MENU	OSD menu
8	-/LEFT	OSD -/Left
9	+ /RIGHT	OSD +/Right
10	SEL_DN	OSD Select down
11	SEL_UP	OSD Select up
12	NC	No connection

The VR for brightness depends on the inverter. The main power load for On/Off is handled by a relay on the controller.

CNV6 - Alternate VGA input : HIROSE DF11-12DP-2DSA compatible

PIN	SYMBOL	DESCRIPTION
1	R	Red, analog
2	DDC_5V	+5V power supply for DDC (optional)
3	G	Green, analog
4	GND	Ground
5	B	Blue, analog
6	GND	Ground
7	HS	Horizontal sync or composite sync, input
8	GND	Ground
9	VS	Vertical sync, input
10	DDC_SCL	DDC serial clock
11	NC	No connection
12	DDC_SDA	DDC serial data

IR1 – Infra-Red sensor connector: JST B3B-XH-A (Matching type : XHP-3)

PIN	SYMBOL	DESCRIPTION
1	GND	Ground
2	STDBY_Vcc	Stand by voltage
3	IR Data	IR data

J2 – LVDS output connector: JAE FI-RE41S-HF (Matching type : JAE FI-RE41HL)

PIN	SYMBOL	DESCRIPTION
1	GND	Ground
2	LVDS_OUT2_B0-	Negative differential LVDS data bit B0
3	LVDS_OUT2_B0+	Positive differential LVDS data bit B0
4	LVDS_OUT2_B1-	Negative differential LVDS data bit B1
5	LVDS_OUT2_B1+	Positive differential LVDS data bit B1
6	LVDS_OUT2_B2-	Negative differential LVDS data bit B2
7	LVDS_OUT2_B2+	Positive differential LVDS data bit B2
8	LVDS_OUT2_BC-	Negative LVDS clock for B channel
9	LVDS_OUT2_BC+	Positive LVDS clock for B channel
10	GND	Ground
11	LVDS_OUT2_B3-	Negative differential LVDS data bit B3
12	LVDS_OUT2_B3+	Positive differential LVDS data bit B3
13	GND	Ground
14	LVDS_OUT2_B4-	Negative differential LVDS data bit B4
15	LVDS_OUT2_B4+	Positive differential LVDS data bit B4
16	GND	Ground
17	LVDS_OUT2_A0-	Negative differential LVDS data bit A0
18	LVDS_OUT2_A0+	Positive differential LVDS data bit A0
19	LVDS_OUT2_A1-	Negative differential LVDS data bit A1
20	LVDS_OUT2_A1+	Positive differential LVDS data bit A1
21	LVDS_OUT2_A2-	Negative differential LVDS data bit A2
22	LVDS_OUT2_A2+	Positive differential LVDS data bit A2
23	LVDS_OUT2_AC-	Negative LVDS clock for A channel
24	LVDS_OUT2_AC+	Positive LVDS clock for A channel
25	GND	Ground
26	LVDS_OUT2_A3-	Negative differential LVDS data bit A3
27	LVDS_OUT2_A3+	Positive differential LVDS data bit A3
28	GND	Ground
29	LVDS_OUT2_A4-	Negative differential LVDS data bit A4
30	LVDS_OUT2_A4+	Positive differential LVDS data bit A4
31	GND	Ground
32	GND	Ground
33	GND	Ground
34	GND	Ground
35	GND	Ground
36	GND	Ground
37	NC	No connection
38	NC	No connection
39	NC	No connection
40	NC	No connection
41	NC	No connection

J3 – LVDS output connector: JAE FI-RE51S-HF (Matching type : JAE FI-RE51HL)

PIN	SYMBOL	DESCRIPTION
1	VLCD_HV	Panel power supply (+12V / 18V) (selected by JA3, JA5 & JA6)
2	VLCD_HV	Panel power supply (+12V / 18V) (selected by JA3, JA5 & JA6)
3	VLCD_HV	Panel power supply (+12V / 18V) (selected by JA3, JA5 & JA6)
4	VLCD_HV	Panel power supply (+12V / 18V) (selected by JA3, JA5 & JA6)
5	VLCD_HV	Panel power supply (+12V / 18V) (selected by JA3, JA5 & JA6)
6	VLCD_LV	Panel power supply (3,3V/5V) (selected by JA3, JA5 & JA6)
7	VLCD_LV	Panel power supply (3,3V/5V) (selected by JA3, JA5 & JA6)
8	VLCD_LV	Panel power supply (3,3V/5V) (selected by JA3, JA5 & JA6)
9	VLCD_LV	Panel power supply (3,3V/5V) (selected by JA3, JA5 & JA6)
10	VLCD_LV	Panel power supply (3,3V/5V) (selected by JA3, JA5 & JA6)
11	GND	Ground
12	GND	Ground
13	GND	Ground
14	GND	Ground
15	GND	Ground
16	OP1	-
17	OP2	-
18	OP3	-
19	OP4	-

Specifications subject to change without notice

20	GND	Ground
21	GND	Ground
22	LVDS_OUT1_A4+	Positive differential LVDS data bit A4
23	LVDS_OUT1_A4-	Negative differential LVDS data bit A4
24	LVDS_OUT1_A3+	Positive differential LVDS data bit A3
25	LVDS_OUT1_A3-	Negative differential LVDS data bit A3
26	GND	Ground
27	LVDS_OUT1_AC+	Positive LVDS clock for A channel
28	LVDS_OUT1_AC-	Negative LVDS clock for A channel
29	GND	Ground
30	LVDS_OUT1_A2+	Positive differential LVDS data bit A2
31	LVDS_OUT1_A2-	Negative differential LVDS data bit A2
32	LVDS_OUT1_A1+	Positive differential LVDS data bit A1
33	LVDS_OUT1_A1-	Negative differential LVDS data bit A1
34	LVDS_OUT1_A0+	Positive differential LVDS data bit A0
35	LVDS_OUT1_A0-	Negative differential LVDS data bit A0
36	GND	Ground
37	LVDS_OUT1_B4+	Positive differential LVDS data bit B4
38	LVDS_OUT1_B4-	Negative differential LVDS data bit B4
39	LVDS_OUT1_B3+	Positive differential LVDS data bit B3
40	LVDS_OUT1_B3-	Negative differential LVDS data bit B3
41	GND	Ground
42	LVDS_OUT1_BC+	Positive LVDS clock for B channel
43	LVDS_OUT1_BC-	Negative LVDS clock for B channel
44	GND	Ground
45	LVDS_OUT1_B2+	Positive differential LVDS data bit B2
46	LVDS_OUT1_B2-	Negative differential LVDS data bit B2
47	LVDS_OUT1_B1+	Positive differential LVDS data bit B1
48	LVDS_OUT1_B1-	Negative differential LVDS data bit B1
49	LVDS_OUT1_B0+	Positive differential LVDS data bit B0
50	LVDS_OUT1_B0-	Negative differential LVDS data bit B0
51	GND	Ground

LED1 – Status LED connector: JST B3B-XH-A (Matching type : XHP-3)

PIN	DESCRIPTION
1	Green LED pin (anode)
2	LED pin common (cathode)
3	Red LED pin (anode)

P2 – DVI-I (Single link) in

PIN	SYMBOL	DESCRIPTION
1	/RX2	TMDS Data 2-
2	RX2	TMDS Data 2+
3	GND	Digital Ground
4	NC	No connection
5	NC	No connection
6	DDC_CLK	DDC Clock
7	DDC_DAT	DDC Data
8	NC	No connection
9	/RX1	TMDS Data 1-
10	RX1	TMDS Data 1+
11	GND	Digital Ground
12	NC	No connection
13	NC	No connection
14	DDC_5V	+5V power supply for DDC (optional)
15	GND	Ground (+5, Analog H/V Sync)
16	HPD	Hot Plug Detect
17	/RX0	TMDS Data 0-
18	RX0	TMDS Data 0+
19	GND	Digital Ground
20	NC	No connection
21	NC	No connection
22	GND	Digital Ground
23	RXC	TMDS Clock+
24	/RXC	TMDS Clock-
C1	RIN	Analog Red
C2	GIN	Analog Green
C3	BIN	Analog Blue
C4	HS_IN	Analog horizontal sync
C5	GND	Ground

C6	NC	No connection
----	----	---------------

P3 – HDMI 1.4 connector

PIN	SYMBOL	DESCRIPTION
1	DATA2+	TMDS Data2+
2	DATA2S	TMDS Data2 Shield
3	DATA2-	TMDS Data2-
4	DATA1+	TMDS Data1+
5	DATA1S	TMDS Data1 Shield
6	DATA1-	TMDS Data1-
7	DATA0+	TMDS Data0+
8	DATA0S	TMDS Data0 Shield
9	DATA0-	TMDS Data0-
10	CLK+	TMDS Clock+
11	CLK@	TMDS Clock Shield
12	CLK-	TMDS Clock-
13	CEC	CEC
14	NC	No connection
15	SCL	SCL (I ² C Serial Clock for DDC)
16	SDA	SDA (I ² C Serial Data Line for DDC)
17	CEC/GND	Ground
18	+5V	+5 V Power (max 50 mA)
19	HPDET	Hot Plug Detect

P4 – Display Port input

PIN	SYMBOL	DESCRIPTION
1	ML Lane 0 (p)	Lane 0 (positive)
2	GND	Ground
3	ML Lane 0 (n)	Lane 0 (negative)
4	ML Lane 1 (p)	Lane 1 (positive)
5	GND	Ground
6	ML Lane 1 (n)	Lane 1 (negative)
7	ML Lane 2 (p)	Lane 2 (positive)
8	GND	Ground
9	ML Lane 2 (n)	Lane 2 (negative)
10	ML Lane 3 (p)	Lane 3 (positive)
11	GND	Ground
12	ML Lane 3 (n)	Lane 3 (negative)
13	CONFIG1	connected to Ground ¹⁾
14	CONFIG2	connected to Ground ¹⁾
15	AUX CH (p)	Auxiliary Channel (positive)
16	GND	Ground
17	AUX CH (n)	Auxiliary Channel (negative)
18	Hot Plug	Hot Plug Detect
19	GND	Ground
20	DP_PWR	Power for connector (3.3 V 500 mA)

P5 – Connector for firmware upgrade: JST B4B-PH-K compatible (Matching type : PHR-4)

PIN	DESCRIPTION
1	+5V
2	USB Data -
3	USB Data +
4	Ground

TEMP1 - External temperature sensor connector : JST 3-way, B3B-XH-A or compatible (Matching type : XHP-3)

PIN	SYMBOL	DESCRIPTION
1	GND	Ground
2	VDD	+3.3V
3	EXT TMP SENSOR	Temperature sensor input

PP2 – Alternate 12V/24VDC input power supply

PIN	DESCRIPTION
1	+12VDC / 24VDC in
2	Ground

PP4 – External panel power input

PIN	DESCRIPTION
1	External panel power
2	Ground
3	External panel power
4	Ground

PP5 – 12V/24VDC input power supply

PIN	DESCRIPTION
1	+12V / +24VDC
2	Ground

* All connectors used may use the compatible type.

CONTROLLER DIMENSIONS

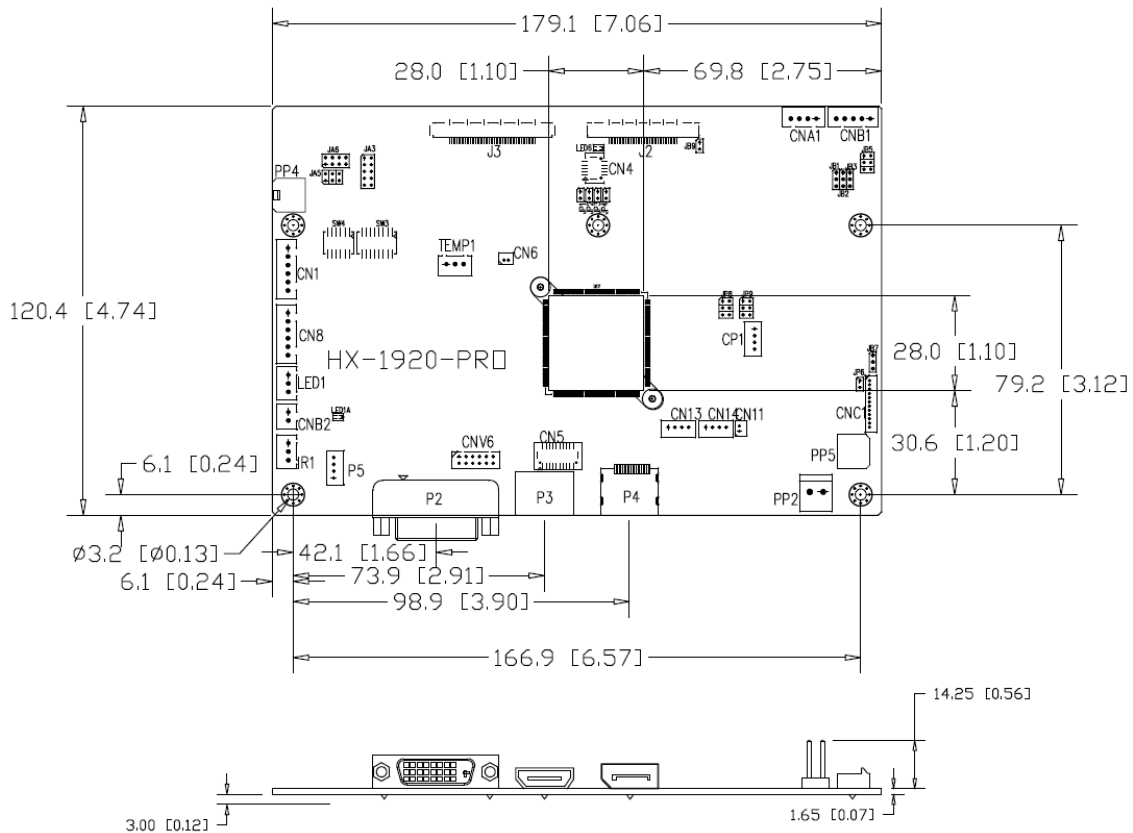

Ready-made 3D Pro-E (SLDPRT) drawing files - Save time and effort for your system volumetric analysis design. Includes jpg file previews. Please go to download at <https://digitalview.com/controllers/hx-1920-pro-lcd-controller.html>

The maximum thickness of the controller is 18.9mm with or without video add-on board (measured from bottom of PCB to top of components, including any underside components & leads). We recommend clearances of:

- 5mm from bottom of PCB - if mounting on a metal plate we also recommend a layer of suitable insulation material is added to the mounting plate surface.
- 10mm above the components
- 3~5mm around the edges

Any of the holes shown above can be used for mounting the PCB, they are 3.2mm in diameter.

CAUTION: Ensure adequate insulation is provided for all areas of the PCB with special attention to high voltage parts such as the inverter.

APPLICATION NOTES

USING THE CONTROLLER WITHOUT BUTTONS ATTACHED

This is very straightforward:

- Firstly setup the controller/display system with the buttons. With controls attached and display system active make any settings for colour, tint and image position as required then switch everything off.
- Remove the control switches, the 12-way (CNC1) cable.
- Use a jumper or similar to connect pins 1 & 2 on CNC1, this will fix the board On.
- Refer to inverter specifications for details as to fixing brightness to a desired level, this may require a resistor, an open circuit or closed circuit depending on inverter.

Summary: On CNC1 the only pins that are used are for On/Off and Brightness (if controller mounted inverter is used). On CNC1 the pins are for momentary type buttons so it doesn't matter that no buttons are attached.

INVERTER CONNECTION

There are potentially 3 issues to consider with inverter connection:

- Power
- Enable
- Brightness

Please read the following sections for a guide to these issues.

Inverter Power: As per the table for CNB1 pin 1 is ground and pin 2 provides 12V/24V DC. This should be matched with the inverter specification: see table.

CNB1

PIN	DESCRIPTION
1	Ground
2	+12V/+24VDC

Remark: For higher power inverter, more current (for 12V/24V) can be taken from CNA1 pin 1.

Enable: This is a pin provided on some inverters for On/Off function and is used by this panel controller for VESA DPMS compliance. If the inverter does not have an enable pin or the enable pin is not used then DPMS will not be operational. Pin 3 should be matched to the inverters specification for the 'enable' or 'disable' pin.

CNB1

PIN	DESCRIPTION
3	Enable

Further, jumpers JB2 & JB3 should be set to match the inverters specification for the enable pin power and High or Low setting: see table.

Ref	Purpose	Note
JB2	Inverter enable voltage	1-2 H = 3.3V, 2-3 H = 5V, OPEN H = open collector
JB3	Inverter control	1-2 H = On, 2-3 L = On

Brightness: There are various methods for brightness control and it is important to consider the specifications for the inverter to be used. Generally the situation is:

- Brightness can control by using a resistor or VR (Variable Resistor).
- Brightness controlled by adding a circuit such as PWM (Pulse Width Modulation).
- No adjustment of brightness is possible.

CNB1 pins 4 & 5 are available for connecting to an inverter or circuit where VR control is supported.

CNB1

PIN	DESCRIPTION
4	VR WIP
5	VR A

This can then be matched with function controls connected to CNC1 pins 4 & 3 or 5: see table.

CNC1

PIN	DESCRIPTION
3	VR A
4	VR WIP
5	VR B

Specifications subject to change without notice

Design Guideline for making VR circuitry :

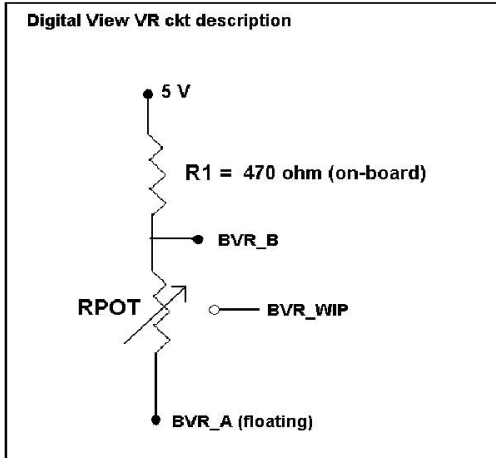

Signal description / Notes :

- 1) R1 : 470ohm on board
- 2) RPOT is an external potentiometer (in-line dip style) that can be plugged directly into CNC1 pins 3,4,5. RPOT must be supplied / installed by user.
- 3) BVR_B : Voltage tapped from “top” of potentiometer, the node of R1 and RPOT.
- 4) BVR_WIP : Voltage tapped from wiper arm of RPOT.
- 5) BVR_A : Voltage tapped from “bottom” of RPOT.

Note : BVR_A voltage is left floating on the controller board. To use this circuit, you need to tie this point to a potential (usually GND, available at CNC1 pin 6).

CNB1 – Backlight inverter connector: JST B5B-XH-A (Matching type : XHP-5)

PIN	SYMBOL	DESCRIPTION
1	GND	Ground
2	VBKL	+12V/24VDC, backlight power supply
3	BLCTRL	On/Off control (enable) – see JB2 & JB3
4	BVR_WIP	Brightness VR - WIP
5	BVR_A	Brightness VR A

CNC1 – OSD switch mount control, Hirose DF13A-12P-1.25H (Mating type : DF13-12S-1.25C)

PIN	SYMBOL	DESCRIPTION
1	PSWIN	Power button A
2	SW_ON	Power button B
3	BVR_A	Backlight Brightness VR pin A
4	BVR_WIP	Backlight Brightness R pin WIP
5	BVR_B	Backlight Brightness VR pin B (470 ohm resistor to +5V Vcc)
6	GND	Ground
7	MENU	OSD menu
8	-/LEFT	OSD -/Left
9	+/RIGHT	OSD +/Right
10	SEL_DN	OSD Select down
11	SEL_UP	OSD Select up
12	NC	No connection

The VR for brightness depends on the inverter. The main power load for On/Off is handled by a relay on the controller.

Example for circuit design :

- 1.) Choose RPOT = 10K
- 2.) Tie BVR_A to GND
- 3.) Circuit analysis gives BVR_WIP as the following (see Figure 1)

$$BVR_WIP = 5 \times (Rbc/10.47)$$

where BVR_WIP is in Volts.
And Rbc is the resistance from the wiper arm to bottom of pot in Kohms.

To evaluate, plug in different values of Rbc :

Rbc	BVR_WIP
0	0 V
2.5 K	1.2 V
5 K	2.4 V
7.5 K	3.6 V
10 K	4.8 V

So this circuit could provide Brightness adjust voltage ranging from 0V to 5V.

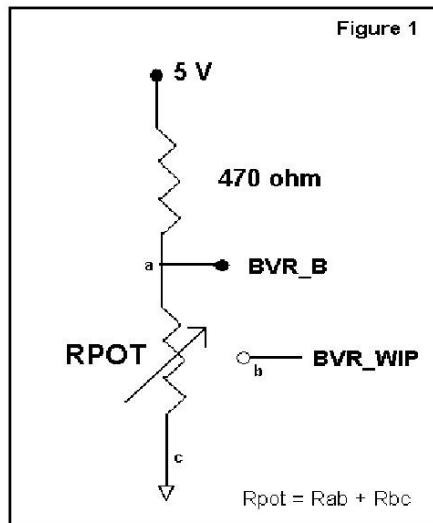

TROUBLESHOOTING

General

A general guide to troubleshooting a flat panel display system it is worth considering the system as separate elements, such as:

- Controller (jumpers, PC settings)
- Panel (controller, cabling, connection, panel, PC settings)
- Backlight (inverter, cabling, backlight tubes)
- Cabling
- Computer system (display settings, operating system)

Through step by step cross checking with instruction manuals and a process of elimination to isolate the problem it is usually possible to clearly identify the problem area.

No image:

- If the panel backlight is not working it may still be possible to just see some image on the display.
- A lack of image is most likely to be caused by incorrect connection, lack of power, failure to provide a signal or incorrect graphic card settings.

Image position:

If it is impossible to position the image correctly, i.e. the image adjustment controls will not move the image far enough, then test using another graphics card. This situation can occur with a custom graphics card that is not close to standard timings or if something is in the graphics line that may be affecting the signal such as a signal splitter (please note that normally a signal splitter will not have any adverse effect).

Image appearance:

- A faulty panel can have blank lines, failed sections, flickering or flashing display
- Incorrect graphics card refresh rate, resolution or interlaced mode will probably cause the image to be the wrong size, to scroll, flicker badly or possibly even no image.
- Incorrect jumper settings on the controller may cause everything from total failure to incorrect image. CAUTION: Do not set the panel power input incorrectly.
- Sparkling on the display: faulty panel signal cable.
- Found "Loading" message displayed on screen message at HDMI / DVI input indicates the unstable HDMI/DVI source detected (especially connected to HDMI splitter) causing flashing image.

Backlight:

Items to check include: Power input, Controls, Inverter and Tubes generally in this order.

If half the screen is dimmer than the other half:

- Check cabling for the inverter.
- For a specific backlight tube check the AC pins orientation (CAUTION: Never reverse any DC power pins).

Also:

- If adjusting brightness control has no effect the chances are that the VR rating or method of adjusting brightness is not compatible or correctly connected to the inverter.
- If system does not power down when there is a loss of signal

Continued failure:

If unit after unit keeps failing consider and investigate whether you are short circuiting the equipment or doing something else seriously wrong.

Generally after common sense issues have been resolved we recommend step by step substitution of known working parts to isolate the problem.

SPECIFICATIONS

Panel compatibility	Compatible with 1920x1200, 1920x1080, 1920x480, 1680x1050, 1600x1200, 1600x900, 1440x900, 1366x768, 1280x1024, 1280x800, 1280x768 1024x768, 1024x600, 800x600, 800x480 and 640x480 resolutions of TFT LCD panels. A specified BIOS and some factory adjustment may be required for individual panel timings.
No. of colors	Up to 3 x 10 bit providing 1.06 billion colors.
Panel power	DC 3.3V, 5V, 10V, 12V, 18V
Panel signal	LVDS
Vertical refresh rate	60Hz at 1920x1200, 60Hz at 1920x1080, 60Hz at UXGA and up to 75Hz other lower resolution
Display clock maximum	165MHz
ADC clock maximum	195 MHz
DVI differential input clock maximum	165MHz
Graphics formats	Standard VESA VGA, SVGA, XGA, SXGA, WXGA, UXGA, WUXGA Other special formats through specified BIOS and factory adjustment.
Graphics auto mode detect	VGA, SVGA, XGA, SXGA, WXGA, UXGA & WUXGA interlaced and non-interlaced
Standard input at source (analog RGB)	VGA analog (15 pin) standard with automatic detection of: Digital Separate Sync; Sync On Green.
Video inputs	DVI-I single link (DVI-D & VGA) HDMI 1.4 DisplayPort 1.2
Functions display	On screen display (OSD) of functions
OSD menu functions	Image controls: Panel brightness/contrast, Saturation, Hue, Color temperature, Sharpness, Aspect ratio etc.
OSD menu controls available	Power On/Off Backlight brightness OSD Menu OSD Select up OSD Select down Setting + Setting -
Control interface	Buttons, RS-232, IR Remote control
Settings memory	Settings are stored in non volatile memory
PC Connectivity	VGA / SVGA / XGA / SXGA / UXGA / WUXGA analog or digital
Controller dimensions	179mm x 120.4mm (7." x 4.74")
Power consumption	4w approx. (not including panel power consumption)
Power load maximum	The controller has an overall 3Amp current limit.
Input voltage	12V/24VDC +/- 5%
Power protection	Fuse fitted (Non resettable type)
DC Power handling	Reverse power polarity protection is equipped on the board
Storage temperature limits	-40°C to +85°C
Operating temperature limits	-40°C to +80°C**
Coating	HumiSeal 1B73 Acrylic Conformal Coating
Calculated Mean Time Between Failures	In excess of 100,000 hours
Operating frequency	12MHz (Scalar) 11.0952MHz (I ² C to Uart)
Latency	32ms [#]
Use of memory on board	- 1 pc SD RAM 1Gbits which is a volatile memory for OSD and frame buffer. - 1 pc flash 64Mbits which is a non-volatile memory for system program. - 1 pc EEPROM 128KBits which is a non-volatile memory for system setting storage. - 1 pc EEPROM 8KBits which is a non-volatile memory for HDCP key. - 2 pc EEPROM 2KBits which is a non-volatile memory for HDMI, DVI EDID.

NOTES

Please note the following:

- For specific panel setup a sample of an LCD may be required (this will be returned) and a copy of the full technical specifications for the panel from the manufacturer.
- Re-layout and custom development services are available.

- Equipment used : Leo Bodnar Electronics Video Signal Input Lag Tester. Controller input port measured based on HDMI port and connect with a Samsung LTM230HT10 (1920x1080) panel.

Specifications subject to change without notice

APPENDIX I – SIGNAL SUPPORT MODE TABLE

ARGB (P1) PORT :

Mode	Resolution	Clk [MHz]	Horizontal freq [KHz]	Vertical freq [Hz]	Sync Mode
V_60	640x480 60Hz	25.175	31.469	59.940	Digital Separate Sync
V_72	640x480 72Hz	31.500	37.861	72.809	Digital Separate Sync
V_72	640x480 72Hz	31.500	37.861	72.809	Sync On Green
V_75	640x480 75Hz	31.500	37.500	75.000	Digital Separate Sync
V_75	640x480 75Hz	31.500	37.500	75.000	Sync On Green
SV_56	800x600 56Hz	36.000	35.156	56.250	Digital Separate Sync
SV_60	800x600 60Hz	40.000	37.879	60.317	Digital Separate Sync
SV_60	800x600 60Hz	40.000	37.879	60.317	Sync On Green
SV_72	800x600 72Hz	50.000	48.077	72.188	Digital Separate Sync
SV_72	800x600 72Hz	50.000	48.077	72.188	Sync On Green
SV_75	800x600 75Hz	49.500	46.875	75.000	Digital Separate Sync
SV_75	800x600 75Hz	49.500	46.875	75.000	Sync On Green
X_60	1024x768 60Hz	65.000	48.363	60.004	Digital Separate Sync
X_60	1024x768 60Hz	65.000	48.363	60.004	Sync On Green
X_70	1024x768 70Hz	75.000	56.476	70.069	Digital Separate Sync
X_70	1024x768 70Hz	75.000	56.476	70.069	Sync On Green
X_75	1024x768 75Hz	78.750	60.023	75.029	Digital Separate Sync
X_75	1024x768 75Hz	78.750	60.023	75.029	Sync On Green
SX_60	1280x1024 60Hz	108	63.81	60.020	Digital Separate Sync
SX_60	1280x1024 60Hz	108	63.81	60.020	Sync On Green
SX_75	1280x1024 75Hz	135	79.976	75	Digital Separate Sync
SX_75	1280x1024 75Hz	135	79.976	75	Sync On Green
UX_60	1600x1200 60Hz	162	75.000	60	Digital Separate Sync

UX_75	1600x1200 60Hz	162	75.000	60	Sync On Green
WUX_60	1920x1080 60Hz	172.8	67.5	60	Digital Separate Sync
WUX_60	1920x1080 60Hz	172.8	67.5	60	Sync On Green

Remark :

The controller has been designed to take a very wide range of input signals however to optimize the PC's graphics performance we recommend choosing 60Hz vertical refresh rate. To support on higher refresh rate over 60Hz, the LCD panel may not support.

HDMI input port (HDMI 1.4):

Resolution
640x480 60Hz
640x480 72Hz
640x480 75Hz
800x600 56Hz
800x600 60Hz
800x600 72Hz
800x600 75Hz
1024x768 60Hz
1024x768 70Hz
1024x768 75Hz
1280x768 60Hz
1280x768 75Hz
1280x1024 60Hz
1280x1024 75Hz
1366x768 60Hz
1400x1050 60Hz
1440x900 60Hz
1600x900 60Hz
1600x1200 60Hz
1680x1050 60Hz
1920x1200 60Hz

Resolution
480i30
480p60
480p59.94
576i25
576p50
720p60
720p59.94
720p50
720p30
720p29.97
720p25
720p24
720p23.976
1080i30
1080i29.97
1080i25
1080p60
1080p59.94
1080p50
1080p30
1080p29.97
1080p25
1080p24
1080p23.976

Display port input port (DP 1.2) :

Resolution
640x480 60Hz
640x480 72Hz
640x480 75Hz
720x480 60Hz
720x576 50Hz
800x600 56Hz
800x600 60Hz
800x600 72Hz
800x600 75Hz
1024x768 60Hz
1024x768 70Hz
1024x768 75Hz
1280x768 60Hz
1280x1024 60Hz
1280x1024 75Hz
1400x1050 60Hz
1440x900 60Hz
1600x900 60Hz
1600x1200 60Hz
1680x1050 60Hz
1920x1200 60Hz

Resolution
720p60
720p59.94
720p50
720p30
720p29.97
720p25
720p24
720p23.976
1080i30
1080i29.97
1080i25
1080p60
1080p59.94
1080p50
1080p30
1080p29.97
1080p25
1080p24
1080p23.976

DVI input port :

Resolution
640x480 60Hz
640x480 72Hz
640x480 75Hz
800x600 56Hz
800x600 60Hz
800x600 72Hz
800x600 75Hz
1024x768 60Hz
1024x768 70Hz
1024x768 75Hz
1280x768 60Hz
1280x768 75Hz
1280x1024 60Hz
1280x1024 75Hz
1366x768 60Hz
1400x1050 60Hz
1440x900 60Hz
1600x900 60Hz
1600x1200 60Hz
1680x1050 60Hz
1920x1200 60Hz

Appendix II – RS-232 control protocols

RS-232 Serial control (Baud rate 9600, 8 bits, 1 stop bit and no parity)

Physical connection :

Controller side
Connector interface : CN8
Mating connector : JST XHP-6

Computer side
Connector interface : Serial port
Mating connector : DB9 Female

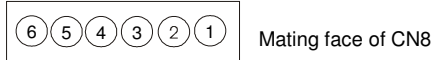

PIN#	Description
4	RS-232 Tx Data
5	Ground
6	RS-232 Rx Data

PIN#	Description
2	RS-232 Rx Data
3	RS-232 Tx Data
5	Ground

Remark :

(1) : RS-232 connection cable, 600mm P/N 426090200-3 can be ordered separately for connection.

Software connection :

The OSD function can be controlled through sending the RS-232 protocol.
The RS-232 program can be custom-made to fit for application or it can be used the serial control program, like Accessport, Telix or Serial Utility program developed by DigitalView. Please contact your local support for information.

1. Commands to implement switch mount control buttons

Function	Command	Description	Remark
Menu button	0xf7	Menu button pressed	Button equivalent
Select-down button	0xfa	Select-down button pressed	Button equivalent
Select-up button	0xfb	Select-up button pressed	Button equivalent
Right/+ button	0xfc	Right/+ button pressed	Button equivalent
Left/- button	0xfd	Left/- button pressed	Button equivalent

2. Parameter setting - immediate, relative, reset and query

Function	Command	Description	Acknowledge (if enabled)
Volume control - left+right channel*	0x80, "a" "A", nn "+" "-" "r" "R" "?"	Set audio (L+R) volume = value/increment/decrement Reset Query	nn = 0x00~ 0x64 (0~100%) Default: 0x32 (50%)
Volume control - on/off (mute)	0x80, "m" "M", "0" "1" "r" "R" "?"	Disable audio output. Enable audio output. Reset Query	"0" - audio off (mute). "1" - audio on. (Default)
Black level control*	0x81, nn "+" "-" "r" "R" "?" "m" "n"	Set brightness = value/increment/decrement Reset Query Current Source Maximum query *1 Minimum query *1	Brightness. nn = 0x00~ 0x64 (0~100%) Default: 0x32 (50%)
Contrast control - all channels*	0x82, "a" "A", nn "+" "-" "r" "R" "?" "m" "n"	Set all contrast = value/increment/decrement Reset Query Maximum query *1 Minimum query *1	Contrast nn = 0x00~ 0x64 (0~100%) Default: 0x32 (50%)
Saturation control*	0x83, nn "+" "-" "r" "R" "?" "m" "n"	Set color = value/increment/decrement Reset Query Maximum query *1 Minimum query *1	nn = 0x00~ 0x64 (0~100%) Default: 0x32 (50%)
Hue control*	0x84, nn "+" "-" "r" "R" "?" "m" "n"	Set tint = value/increment/decrement Reset Query Maximum query *1 Minimum query *1	NTSC tint (In NTSC mode only) nn = 0x00~ 0x64 (0~100%) Default: 0x32 (50%)
Phase (tuning) control	0x85, nn "+" "-" "?"	Set dot clock phase = value/increment/decrement Query	Dot clock phase. (In PC mode only)
Image H position	0x86, nnnn "+" "-" "?"	Set img_hpos = value/increment/decrement Query	Image horizontal position. (In PC mode only)
Image V position	0x87, nnnn "+" "-" "?"	Set img_vpos = value/increment/decrement Query	Image vertical position. (In PC mode only)
Sharpness*	0x8a, nn "+" "-"	Set sharpness = value/increment/decrement	Sharpness. (Video Mode Source only)

Specifications subject to change without notice

	"r" "R" "?"	Reset Query	nn = 0x00~ 0x64 (0~100%) Default: 0x32 (50%)
Frequency	0x8b, nnnn "+" "-" "?"	Set frequency = Value/increment/decrement Query	Graphic mode H active size (in pixels)
Scaling Mode	0x8c, "0" "1" "2" "3" "9" "A" "B" "C" "D" "r" "R" "?"	Set graphic image scaling mode = value Reset Query	Image expansion on/off. "0" – 1:1 "1" – fill screen "2" – fill to aspect ratio "9" – 4:3 "A" – 16:9 "F" - 5:4
Set display orientation	0x8e, n "r" "R" "?"	Set display orientation = value/increment/decrement Reset Query	"0" – Normal. "1" – Vertical Flip. "2" – Horizontal Flip. "3" – 180. "6" - 90 "4" - 270
OSD transparency *	0x92, nn "+" "-" "r" "R" "?"	Set OSD transparency = value/increment/decrement Reset Query	nn = 0x00~ 0x64 (0~100%) Default: 0x00 (No transparency)
OSD menu timeout	0x93, nn "+" "-" "r" "R" "?"	Select menu timeout = value/increment/decrement Reset Query	OSD menu timeout value. nn = 0x35 - 0x3C (5 - 60 sec) if value > max available step, set it to the max available step.
Select OSD language	0x95, n "r" "R" "?"	Select language = English, Chinese,... Reset Query	"0" – English. "2" - French "3" – Spanish
Input main select	0x98, nn "+" "-" "r" "R" "?"	Select input main = PC or VIDEO or next available Reset Query	Main selected. "0x41,0x31" ARGB "0x46,0x31" DVI "0x48,0x31" HDMI "0x50, 0x31" Display Port
Auto Source Seek	0x99, nn , "0" "1" "?"	Set Auto source enable = *1 Source Disable/ Enable Query	"0" – Disable "1" – Enable (Default)
Source Layout	0x9a, n "r" "R" "?"	Select source layout = Single, PIP, PBP, PBPT Reset, Query	Query: "0"- Single "1"- Picture in Picture (PIP) "2"- Picture by Picture (PBP)
Gamma value select *	0x9d, n "r" "R" "?"	Select GAMMA value = Value Reset Query	GAMMA value: "5" – 1.8, "7" – 2.0, "2" – 2.2 (default), "A" – 2.4, "C" – 2.6
Auto power off	0x9f, "0" "1" "r" "R" "?"	Set power down option = On/Off Reset Query	"0" – Off. "1" – On.
Hotkey 1	0xa0, "1", n "r" "R" "?"	Set Hotkey 1= Value Reset Query	"1" - Volume "2" – Black level (Default) "3" – contrast "4" - Saturation "5" – inputs "9" - PIP Size "B" – No function "E" – Aspect Ratio "F" – Rotate

			<p>"G" – Hue "H" – Brightness "I" – Auto Adjust "K" - PIP ON/OFF</p>
Hotkey 2	<p>0xa0, "2", n "r" "R" "?"</p>	<p>Set Hotkey 2 = value Reset Query</p>	<p>"1" - Volume "2" – Black level "3" – contrast (Default) "4" - Saturation "5" – inputs "9" - PIP Size "B" – No function "E" – Aspect Ratio "F" – Rotate "G" – Hue "H" – Brightness "I" – Auto Adjust "K" - PIP ON/OFF</p>
Runtime counter	<p>0xa1, nnnnn "r" "R" "?"</p>	<p>runtime counter value = nnnnn (* 0.5 hour) Reset Query</p>	<p>Runtime = nnnnn. Max. input = 0x1ffe (0x1ffe * 0.5 hour = 65535 hours) Runtime counter counts when backlight is on</p>
PIP window size select	<p>0xa6, nn "r" "R" "?"</p>	<p>Select PIP window size = PIP window size value Reset Query</p>	<p>nn: '0x30, 0x31' – Size 1 '0x30, 0x32' – Size 2 '0x30, 0x33' – Size 3 '0x30, 0x34' – Size 4 '0x30, 0x35' - Size 5</p>
PIP source select	<p>0xa7, n "r" "R" "?"</p>	<p>Select input main = Video source value Reset Query</p>	<p>Main selected. 0x40 0x30 : PIP OFF "0x41,0x31"- ARGB "0x46,0x31"- DVI "0x48,0x31" HDMI "0x50, 0x31" Display Port</p>
Colour temperature select	<p>0xb3, n "r" "R" "?"</p>	<p>Select colour temperature = value Reset Query</p>	<p>Main selected. "5" – 9300K. "6" – 7500K.(Default) "2" – 6500K. "3" – 5000K "4" - User</p>
Red level for selected colour temperature *	<p>0xb4, nn "+" "-" "r" "R" "?" "m" "n"</p>	<p>Set the level of the red channel for the selected colour temp. = value/increment/decrement Reset Query Maximum query Minimum query</p>	<p>Red level for selected colour temperature. nn: 0x00~ 0x64 (0~100) Default: 0x64</p>
Green level for selected colour temperature *	<p>0xb5, nn "+" "-" "r" "R" "?" "m" "n"</p>	<p>Set the level of the green channel for the selected colour temp. = value/increment/decrement Reset Query Maximum query Minimum query</p>	<p>Green level for selected colour temperature nn: 0x00~ 0x64 (0~100) Default: 0x64</p>
Blue level for selected colour temperature *	<p>0xb6, nn "+" "-" "r" "R" "?" "m"</p>	<p>Set the level of the blue channel for the selected colour temp. = value/increment/decrement Reset Query Maximum query</p>	<p>Blue level for selected colour temperature. nn: 0x00~ 0x64 (0~100) Default: 0x64</p>

Specifications subject to change without notice

	"n"	Minimum query	
Graphic horizontal resolution enquiry	0xb7	Horizontal resolution (in pixels) in 3 digit hex number	"nnn" = horizontal resolution
Graphic vertical resolution enquiry	0xb8	Vertical resolution (in lines) in 3 digit hex number	"nnn" = vertical resolution
Graphic horizontal sync frequency enquiry	0xb9	Horizontal sync frequency (in units of 100Hz) in 3 digit hex number	"nnn" = horizontal frequency
Graphic vertical sync frequency enquiry	0xba	Vertical sync frequency (in units of Hz) in 3 digit hex number and 1 char	"nnnn" = vertical frequency nnn = 3 digit hex c= "i" or "p" interlace or Progressive
OSD status enquiry	0xbb	Status of OSD	"0" – OSD turned off "1" – OSD turned on
OSD turn off	0xbd	Turn off the OSD.	"0" – fail. "1" – successful.
Query Revision Number	0xcb, "3"	Read Revision Number	"nn" = Revision number
Backlight control*	0xe0, nn "+" "-" "=" "R" "r" "?"	Set Backlight = value/increment/decrement Display OSD indicator Reset Query	Backlight. nn = 0x00~ 0x64 (0~100%) Default: 0x64 (100%)
Backlight On/Off	0xe1, "0" "1" "R" "r" "?"	Backlight Off / Backlight On /Status	"0" – Backlight Off "1" – Backlight On.(Default) "?" – Backlight On/Off Query
Monochrome mode (Output Channel Select)	0xe2 "0" "1" "2" "3" "4" "5" "6" "R" "r" "?"	Off/ Blue Only/ Red Only/ Green Only/ Blue Mono/ Red Mono/ Green Mono/	"0" – Off "1" – Blue Only "2" – Red Only "3" – Green Only "4" – Blue Mono "5" – Red Mono "6" – Green Mono
Backlight D/A / PWM	0xe5 "0" "1" "R" "r" "?"	Set : PWM or D/A Reset Query	"0" – PWM "1" – D/A (Default)
Backlight PWM Frequency	0xe6, nnn "+" "-" "R" "r" "?"	Set Backlight PWM Frequency = value/increment/decrement Reset Query	+/- 20Hz Value 100Hz : "0", "6", "4" 120Hz : "0", "7", "8" 140Hz : "0", "8", "C" 160Hz : "0", "A", "0" (Default) 180Hz : "0", "B", "4" 200Hz : "0", "C", "8" 220Hz : "0", "D", "C" 240Hz : "0", "F", "0" 260Hz : "1", "0", "4" 280Hz : "1", "1", "8" 300Hz : "1", "2", "C" 320Hz : "1", "4", "0" 340Hz : "1", "5", "4" 360Hz : "1", "6", "8" 380Hz : "1", "7", "C" 400Hz : "1", "9", "0" 420Hz : "1", "A", "4" 440Hz : "1", "B", "8"
Backlight Invert	0xe7 "0" "1"	Set On or Off	"0" – Off (Default) "1" – On

Specifications subject to change without notice

	"R" "r" "?"	Reset Query	
Light Detector	"0xee", "0x4A" "0" "1" "R" "r" "?" "S" "s"	Light Detector Off / Light Detector On Light Detector On/Off Query Light Detector Value Query	"0" –Light Detector Off (Default) "1" –Light Detector On. "?" – Light Detector On/Off Query "S" "s" –Light Detector Value Query 0x00~0xFF
Minimum Backlight Value	0xee, "0x5C" nn "+" "-" "R" "r" "?"	Set Minimum Backlight value = value / increment / decrement Reset Query	Minimum Backlight value/ Range : nn: 0x00 ~ 0x32 (0~50%) Default: 25%
Default Power	"0xee", "0x6B", "0x50" "0" "1" "?"	Default power state after supplying power to controller Off On Query	"0" - default power off "1" - default power on

3. Other control

Function	Command	Description	Acknowledge (if enabled)
Select RS-232 acknowledge	0xc1, "0" "1"	Disable/enable command acknowledge.	"0" – acknowledge disabled. "1" – acknowledge enabled.
Auto-setup	0xc3	Start auto-setup of current vmode.	"0" – fail. "1" – successful.
Command availability	0xc4, n	Check whether a command is available.	"0" – not available. "1" – available.
Soft Power On/Off	0xc8, "0" "1" "?"	Soft power off/on query	"0" - Soft power off "1" - Soft power on
Query video input status	0xc9	Query the status of the primary & pip status	"nn,nn" = input status "nn,xx" digit = primary status: "0", "0" : invalid "A", "1" ARGB "F", "1" DVI "H", "1" HDMI "P", "1" Display Port "xx,nn" = PIP input status: "0", "0": invalid "A", "1" ARGB "F", "1" DVI "H", "1" HDMI "P", "1" Display Port
Query BIOS version	0xcb, "0"	Read BIOS version	BIOS version "VV.YY.ZZ" VV = V0 or E0, V0 = Release version E0 = Engineering Sample YY= Version Number ZZ= Customer Number
Query PCBA number	0xcb, "1"	Read PCBA number	"nnnnn" = PCBA number SVX-1920-PRO= "41773"
Query Revision Number	0xcb, "3"	Read Revision Number	"nn" = Revision number AA in firmware version no. "VV.YY.ZZ.AA"
Reset to Factory Defaults	0xce	Reset all parameters to default value	"1" – successful.

Remark: “*” - This command write to memory and therefore should not be set to write too frequency. We recommend no more than 1,000,000 times over a 3 years operating period.

**n = 1-byte ascii-coded hex number, e.g., parameter value of 0x1 is represented by “1” (0x31).
 mn or nn = 2-byte ascii-coded hex number, e.g., parameter value of 0x1e is represented by “1”, “e” | “E” (0x31, 0x6e|0x4e).**

Please refer to the ASCII to Hex convert table below.

Hex to ASCII conversion table

Hex	ASCII	Hex	ASCII	Hex	ASCII	Hex	ASCII
0x30	0	0x41	A	0x61	a	0x2B	+
0x31	1	0x42	B	0x62	b	0x2D	-
0x32	2	0x43	C	0x63	c	0x3F	?
0x33	3	0x44	D	0x64	d		
0x34	4	0x45	E	0x65	e		
0x35	5	0x46	F	0x66	f		
0x36	6	0x47	G	0x67	g		
0x37	7	0x48	H	0x68	h		
0x38	8	0x49	I	0x69	i		
0x39	9	0x4A	J	0x6A	j		
		0x4B	K	0x6B	k		
		0x4C	L	0x6C	l		
		0x4D	M	0x6D	m		
		0x4E	N	0x6E	n		
		0x4F	O	0x6F	o		
		0x50	P	0x70	p		
		0x51	Q	0x71	q		
		0x52	R	0x72	r		
		0x53	S	0x73	s		
		0x54	T	0x74	t		
		0x55	U	0x75	u		
		0x56	V	0x76	v		
		0x57	W	0x77	w		
		0x58	X	0x78	x		
		0x59	Y	0x79	y		
		0x5A	Z	0x7A	z		

Appendix III – Mapping definition

- Definition of Mapping A :

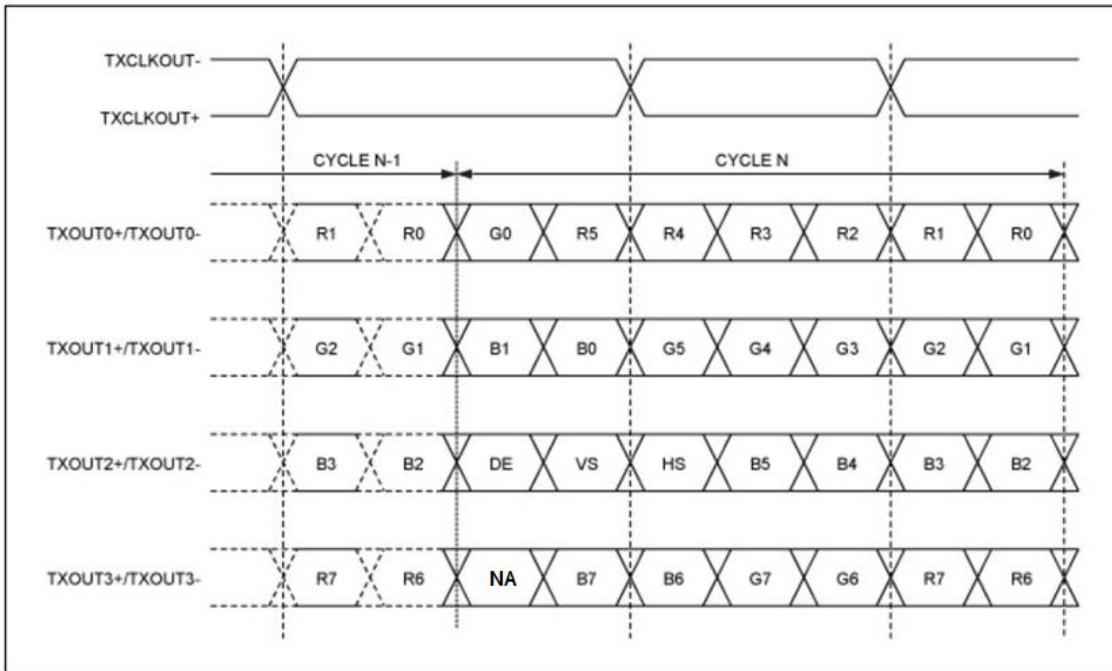

- Definition of Mapping B :

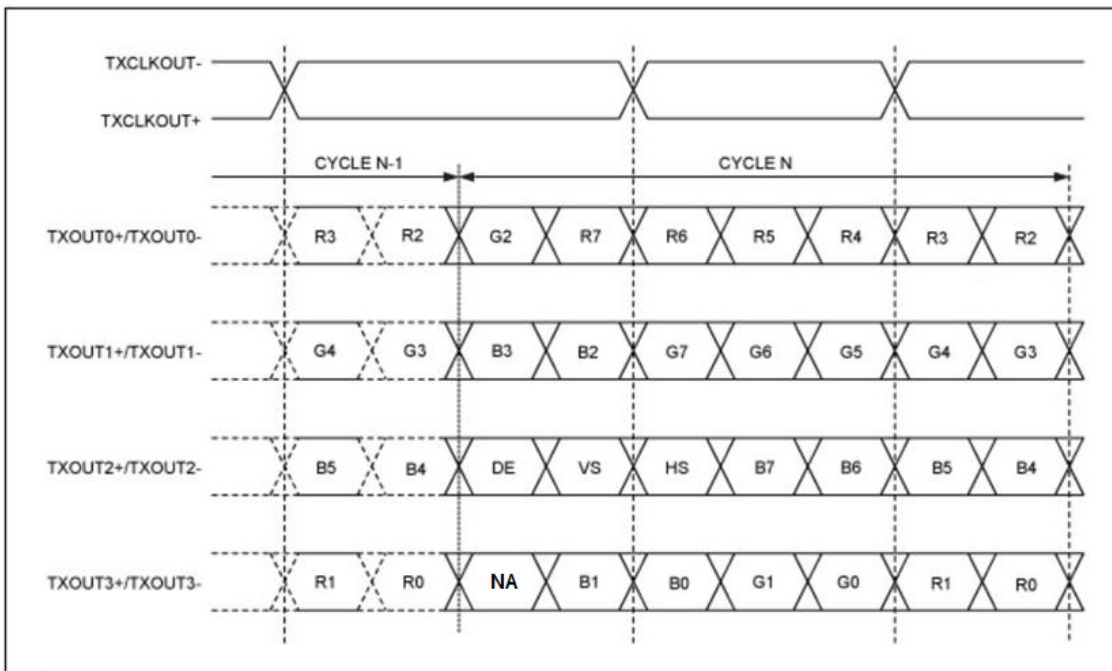

- Definition of VESA :

DPort Output Pair	Bit 6	Bit 5	Bit 4	Bit 3	Bit 2	Bit 1	Bit 0
DB[7:6] / TXDEC							
DB[3:2] / TXDE0	GE0	RE5	RE4	RE3	RE2	RE1	RE0
DB[5:4] / TXDE1	BE1	BE0	GE5	GE4	GE3	GE2	GE1
DB[9:8] / TXDE2	EN	VS	HS	BE5	BE4	BE3	BE2
DG[3:2] / TXDE3	field/prg	BE7	BE6	GE7	GE6	RE7	RE6
DG[5:4] / TXDE4	low	BE9	BE8	GE9	GE8	RE9	RE8
DG[7:6] / TXDO0	GO0	RO5	RO4	RO3	RO2	RO1	RO0
DG[9:8] / TXDO1	BO1	BO0	GO5	GO4	GO3	GO2	GO1
DR[5:4] / TXDO2	EN	VS	HS	BO5	BO4	BO3	BO2
DR[7:6] / TXDO3	field/prg	BO7	BO6	GO7	GO6	RO7	RO6
DR[9:8] / TXDO4	low	BO9	BO8	GO9	GO8	RO9	RO8
DR[3:2] / TXDOC							

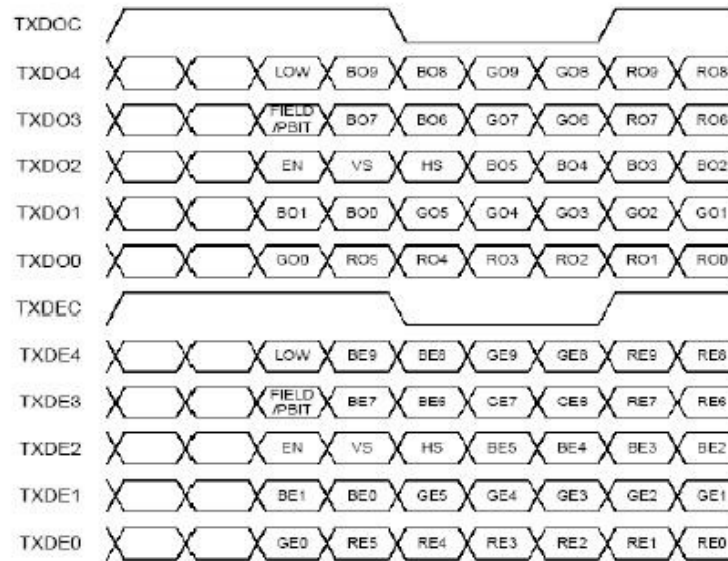

- Definition of JEIDA :

DPort Output Pair	Bit 6	Bit 5	Bit 4	Bit 3	Bit 2	Bit 1	Bit 0
DB[7:6] / TXDEC							
DB[3:2] / TXDE0	GE4	RE9	RE8	RE7	RE6	RE5	RE4
DB[5:4] / TXDE1	BE5	BE4	GE9	GE8	GE7	GE6	GE5
DB[9:8] / TXDE2	EN	VS	HS	BE9	BE8	BE7	BE6
DG[3:2] / TXDE3	field/prg	BE3	BE2	GE3	GE2	RE3	RE2
DG[5:4] / TXDE4	low	BE1	BE0	GE1	GE0	RE1	RE0
DG[7:6] / TXDO0	GO4	RO9	RO8	RO7	RO6	RO5	RO4
DG[9:8] / TXDO1	BO5	BO4	GO9	GO8	GO7	GO6	GO5
DR[5:4] / TXDO2	EN	VS	HS	BO9	BO8	BO7	BO6
DR[7:6] / TXDO3	field/prg	BO3	BO2	GO3	GO2	RO3	RO2
DR[9:8] / TXDO4	low	BO1	BO0	GO1	GO0	RO1	RO0
DR[3:2] / TXDOC							

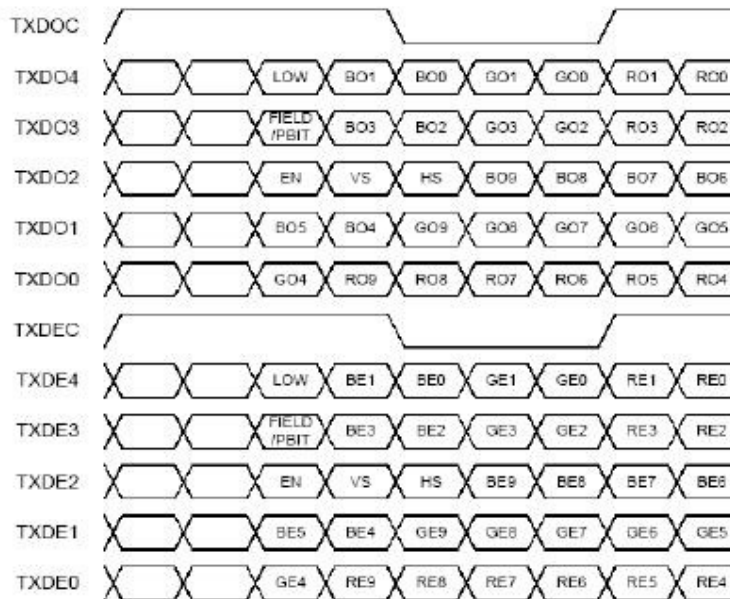

Appendix IV – Auto Color Gain

The Auto Color Gain function is supported in the ARGB mode only and is designed to calibrate the controller to the incoming video signal. In order to calibrate correctly, the display must be displaying a FULL White image (see illustration below) when the function is used. The internal processor of the video controller chip will then execute a process to adjust the relative values of the RGB signals to achieve the best performance. The parameters of the corrected RGB values are then stored in the controller and are unaffected by the Reset Factory Defaults function.



This reference pattern is for 1280x1024 resolution and it needs to set your ARGB input source to 1280x1024 resolution before performing the Auto Color Gain function. The position of the black vertical bar in the pattern at the right side is important. It will affect the calibration result if you are setting the ARGB input to other resolution.

Warning - If the Auto Color Gain is executed without an appropriate image being displayed, then the process will set incorrect values and the display colors will be distorted. If this occurs, then it can either be corrected by performing the process correctly or if this is not possible then the Reset Color Gain function can be used. This function will reset the stored RGB values to a set of approximate values.

Appendix V – DV remote control unit work for HX-1920-PRO

P/N 5590001xx-3 :
DigitalView remote control unit
(without DV logo silk screen
printing)



BUTTON	FUNCTION
POWER BUTTON	Soft power ON/OFF button.
SEL UP (^) / SEL DN (v)	1. In OSD menu, pressing "SEL UP" button to move previous level of selection. 2. In OSD menu, pressing "SEL DN" button to move next level of selection or to CONFIRM the selection.
+ BUTTON	When OSD menu displayed, press this button to select functions (forward) or increase the values.
- BUTTON	When OSD menu displayed, press this button to select functions (backward) or decrease the values.
AV/TV BUTTON	Use to select the input source. (VGA/DVI/HDMI/..)
OSD NEXT BUTTON	Use to turn on/off the OSD menu.
Mute	Mute / Un-mute audio
STOP (VGA) BUTTON	Press this button in the non OSD menu display mode to select VGA source.
DVI BUTTON	Press this button in the non OSD menu display mode to select DVI source.
HDMI BUTTON	Press this button in the non OSD menu display mode to select HDMI source.
PIP	Toggle between PIP mode and 1P mode.

Appendix VI – PIP mix table

PIP \ MAIN	VGA (P2/CNV6)	DVI-D (P2)	HDMI (P3)	Displayport (P4)
VGA (P2/CNV6)	✓	✓	✓	✓
DVI (P2)	✓	✓	✓	✓
HDMI (P3)	✓	✓	✓	✓
Displayport (P4)	✓	✓	✓	✓

Appendix VII – Light Sensor Function work for HX-1920-PRO

HX-1920-PRO provides an interface to enable automatic backlight adjustment. It is possible to connect with a light sensor directly to the controller board.

Use of the light sensor board P/N 416021330-3 and light sensor cable P/N 426305900-3 connect to the HX-1920-PRO via CN6 connector or use the light sensor cable P/N 426321940-3 as shown below :

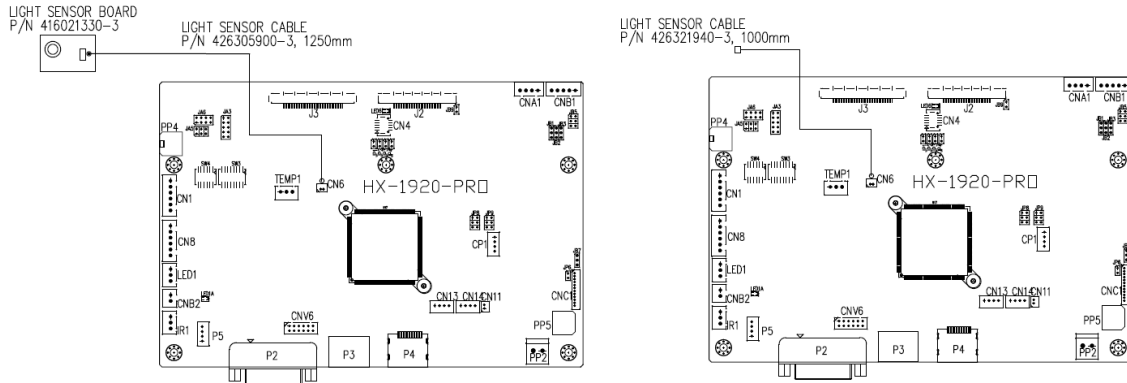

Digital View provides a user-friendly software program (TCP-IP Serial Utility V1.13 or later revision) can set thresholds for ambient light and the LCD panel backlight adjustment.

The settings can be Open/Save as by file.

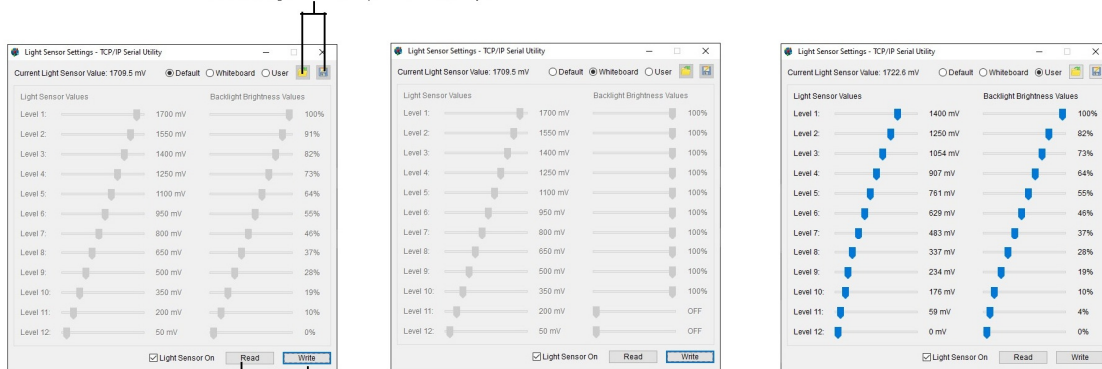

Read the current settings from controller

Confirm to write the current settings onto controller

Three auto dimming modes:

- Default - All the dimming level are preset as linear backlight %.
- Whiteboard - When room light 'ON', set backlight 100%, otherwise 'OFF' the backlight.
- User - Only this mode can be user configurable.

When designing a monitor a light sensor can be placed in a suitable location to detect changes in lighting and adjust the LCD panel backlight brightness appropriately.

WARRANTY

The products are warranted against defects in workmanship and material for a period of three (3) year from the date of purchase provided no modifications are made to it and it is operated under normal conditions and in compliance with the instruction manual.

The warranty does not apply to:

- Product that has been installed incorrectly, this specifically includes but is not limited to cases where electrical short circuit is caused.
- Product that has been altered or repaired except by the manufacturer (or with the manufacturer's consent).
- Product that has subjected to misuse, accidents, abuse, negligence or unusual stress whether physical or electrical.
- Ordinary wear and tear.

Except for the above express warranties, the manufacturer disclaims all warranties on products furnished hereunder, including all implied warranties of merchantability and fitness for a particular application or purpose. The stated express warranties are in lieu of all obligations or liabilities on the part of the manufacturer for damages, including but not limited to special, indirect consequential damages arising out of or in connection with the use of or performance of the products.

CAUTION

Whilst care has been taken to provide as much detail as possible for use of this product it cannot be relied upon as an exhaustive source of information. This product is for use by suitably qualified persons who understand the nature of the work they are doing and are able to take suitable precautions and design and produce a product that is safe and meets regulatory requirements.

LIMITATION OF LIABILITY

The manufacturer's liability for damages to customer or others resulting from the use of any product supplied hereunder shall in no event exceed the purchase price of said product.

TRADEMARKS

The following are trademarks of Digital View Ltd:

- Digital View
- HX-1920-PRO

CONTACT DETAILS

Digital View has offices in Asia, Europe and USA :

USA

Digital View Inc.
18440 Technology Drive
Building 130
Morgan Hill,
California, 95037
USA

Tel: (1) 408-782 7773 **Fax:** (1) 408-782 7883

Sales: ussales@digitalview.com

EUROPE

Digital View Ltd.
The Lake House
Knebworth Park
Herts, SG3 6PY
UK

Tel: +44-(0)20-7631-2150 **Fax:** +44-(0)20-7631-2156

Sales: uksales@digitalview.com

ASIA

Digital View Ltd
Units 705-708, 7/F Texwood Plaza
6 How Ming Street
Kwun Tong
Hong Kong

Tel: (852) 2861 3615 **Fax:** (852) 2520 2987

Sales: hksales@digitalview.com

WEBSITE

www.digitalview.com

Revision History

Date	Rev No.	Page	Summary
21 Jan 2022	1.00	All	First issued