

## ALC80E162DF200

Aliases (A547EH162M200E)

ALC80, Aluminum Electrolytic, 1,600 uF, 20%, 200 VDC, -40/+105°C

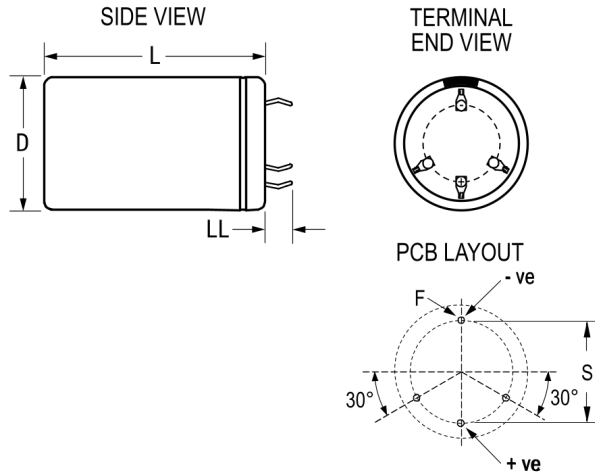

Click [here](#) for the 3D model.

### Dimensions

D	35mm +1mm
L	50mm +/-2mm
S	22.5mm +/-0.1mm
LL	4mm +/-1mm
F	2mm +/-0.1mm

### Packaging Specifications

Sleeving	Yes
Packaging	Bulk, Bag

### General Information

Series	ALC80
Dielectric	Aluminum Electrolytic
Description	Snap-In, Aluminum Electrolytic
RoHS	Yes
Lead	4 Pin Short
AEC-Q200	No
Halogen Free	Yes
Component Weight	80 g
Notes	Dimensions D And L Include Sleeving.
Shelf Life	156 Weeks

### Specifications

Capacitance	1,600 uF
Capacitance Tolerance	20%
Voltage DC	200 VDC, 230 VDC (Surge)
Temperature Range	-40/+105°C
Rated Temperature	105°C
Life	8000 Hrs (Rated Voltage And Ripple Current At 105C), 13000 Hrs (Rated Voltage At 105C)
Resistance	136.9 mOhms (100Hz 20C), 83.72 mOhms (10kHz 20C)
Ripple Current	3.972 Amps (100Hz 105C), 7.943 Amps (10kHz 105C)
Leakage Current	960 uA (5min 20°C)