

## STRADA-SQ-ME

Beam with excellent longitudinal luminance uniformity fulfilling EN13201 M-class requirements where road width is equal to or less than the pole height. Version with location pins and installation tap

### TECHNICAL SPECIFICATIONS:

Dimensions	25.0 mm
Height	8.8 mm
Fastening	tape, pin, screw
Colour	clear
Box size	480 x 280 x 300 mm
Box weight	8.8 kg
Quantity in Box	2058 pcs
ROHS compliant	yes ⓘ



### MATERIAL SPECIFICATIONS:

Component	Type	Material	Colour
STRADA-SQ-ME	Single lens	PMMA	clear
ROSE-TAPE	Tape	PU tape	

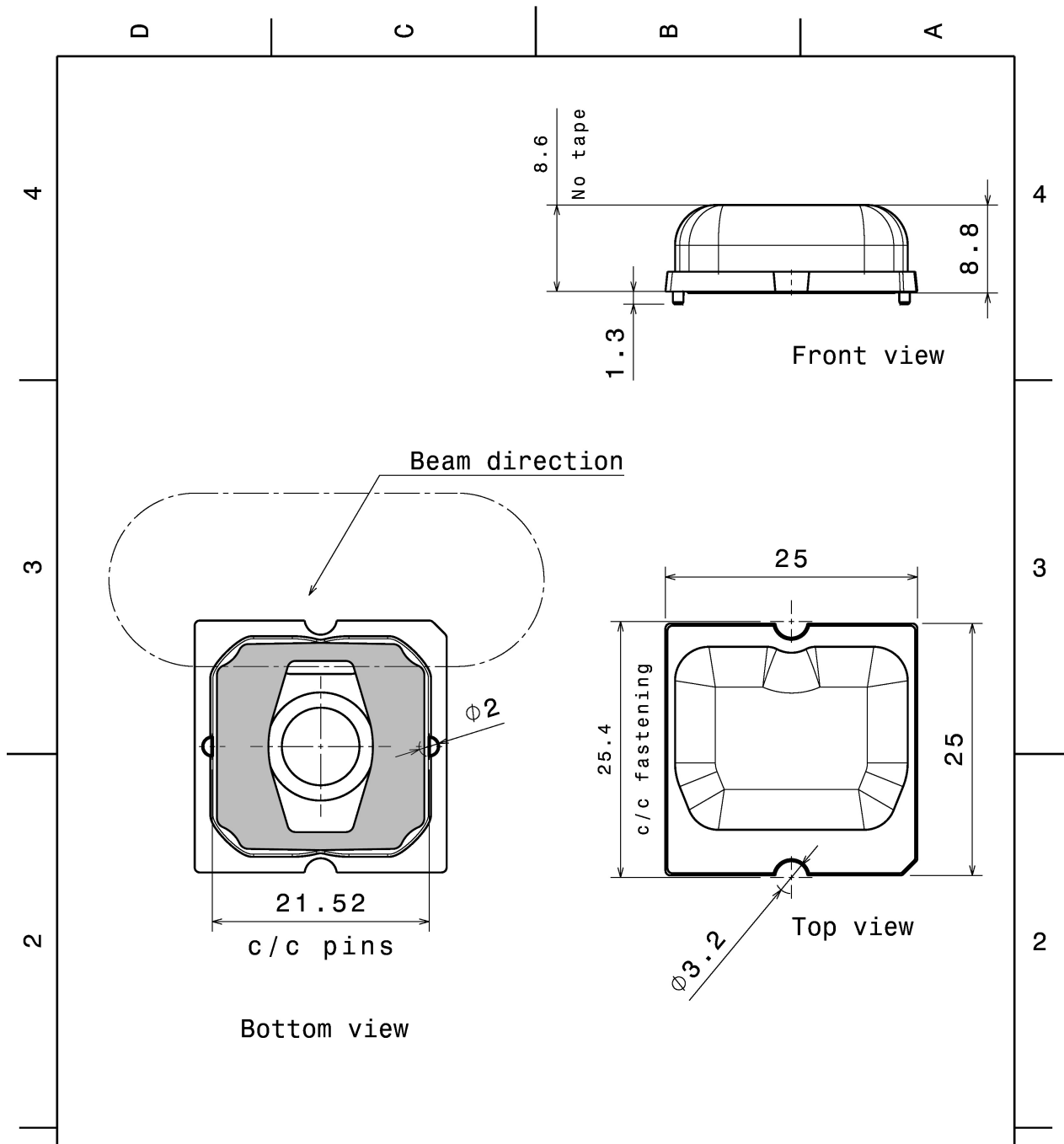

Tolerances if not otherwise shown According to DIN ISO 2768-1 Linear measures: Up to 30mm class M, otherwise class C. According to DIN ISO 2768-2 Form and position: class L		<b>LEDiL</b> LediL Oy Salorankatu 10 FIN 24240 SALO Finland	
THIRD ANGLE PROJECTION: 		<b>DRAWING TITLE</b> <b>STRADA-SQ-ME_Mechanicaldrawing</b>	
This drawing is the property of LEDiL Oy. It may not be reproduced, copied or communicated without a written agreement with LEDiL Oy.		<b>SIZE</b> <b>A4</b>	<b>PART NUMBER</b> -
		<b>SCALE</b> 2:1	<b>WEIGHT</b> -
		<b>SHEET</b> 1/1	

#### PHOTOMETRIC DATA (MEASURED):

#### CREE

LED MK-R  
 FWHM Asymmetric  
 Efficiency 93 %  
 Peak intensity 0.640 cd/lm  
 LEDs/each optic 1  
 Light colour White  
 Required components:

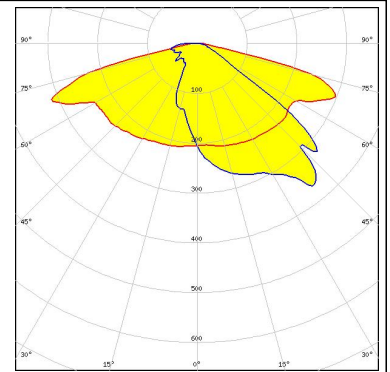

#### CREE

LED XHP35 HD  
 FWHM Asymmetric  
 Efficiency 93 %  
 Peak intensity 0.850 cd/lm  
 LEDs/each optic 1  
 Light colour White  
 Required components:

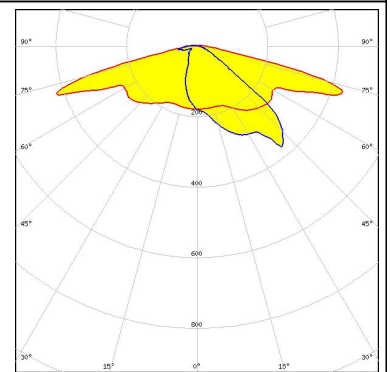

#### CREE

LED XHP50  
 FWHM Asymmetric  
 Efficiency 92 %  
 Peak intensity 0.580 cd/lm  
 LEDs/each optic 1  
 Light colour White  
 Required components:

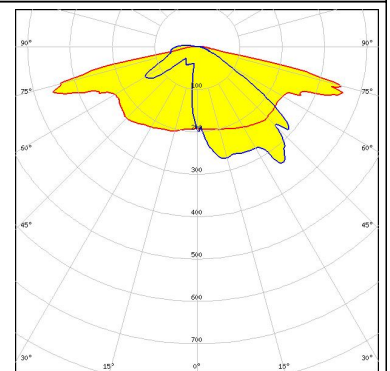

#### LUMILEDS

LED LUXEON M/MX  
 FWHM Asymmetric  
 Efficiency 92 %  
 Peak intensity 0.670 cd/lm  
 LEDs/each optic 1  
 Light colour White  
 Required components:

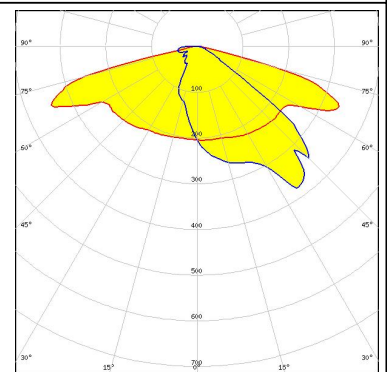

#### PHOTOMETRIC DATA (MEASURED):

##### LUMILEDS

LED LUXEON MZ  
 FWHM Asymmetric  
 Efficiency 93 %  
 Peak intensity 0.960 cd/lm  
 LEDs/each optic 1  
 Light colour White  
 Required components:

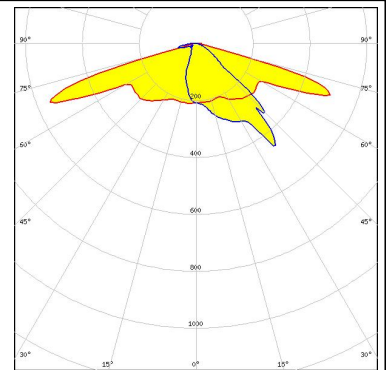

##### LUMILEDS

LED LUXEON XR-M linear 1x3, 1x4, 1x5  
 FWHM Asymmetric  
 Efficiency 93 %  
 Peak intensity 0.670 cd/lm  
 LEDs/each optic 1  
 Light colour White  
 Required components:

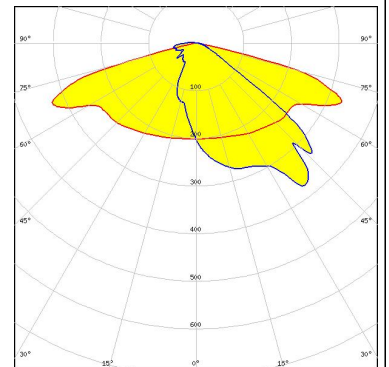

##### NICHIA

LED NV4x144A  
 FWHM Asymmetric  
 Efficiency 91 %  
 Peak intensity 0.540 cd/lm  
 LEDs/each optic 1  
 Light colour White  
 Required components:

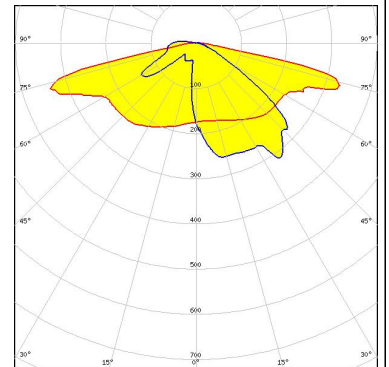

##### NICHIA

LED NVSW319B  
 FWHM Asymmetric  
 Efficiency 91 %  
 Peak intensity 0.930 cd/lm  
 LEDs/each optic 1  
 Light colour White  
 Required components:

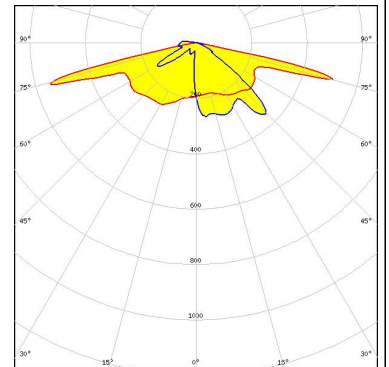

## PHOTOMETRIC DATA (MEASURED):

**OSRAM**  
Opto Semiconductors

LED	Duris S10
FWHM	Asymmetric
Efficiency	90 %
Peak intensity	0.510 cd/lm
LEDs/each optic	1
Light colour	White
Required components:	

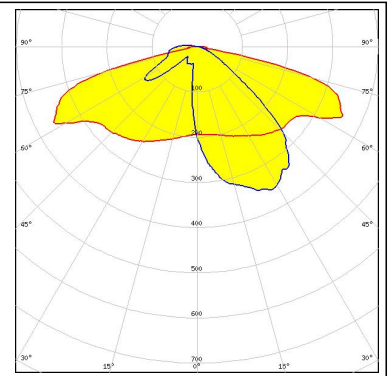

#### PHOTOMETRIC DATA (SIMULATED):



LED MHB-A/B  
 FWHM Asymmetric  
 Efficiency %  
 Peak intensity cd/lm  
 LEDs/each optic 1  
 Light colour White  
 Required components:

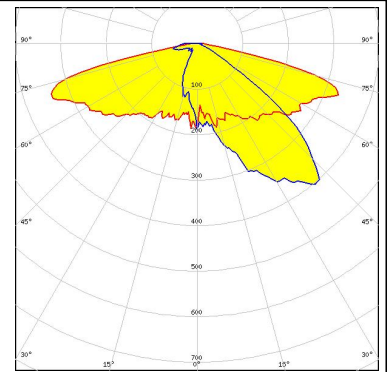

LED LUXEON 5050 Round LES  
 FWHM Asymmetric  
 Efficiency 94 %  
 Peak intensity 0.750 cd/lm  
 LEDs/each optic 1  
 Light colour White  
 Required components:

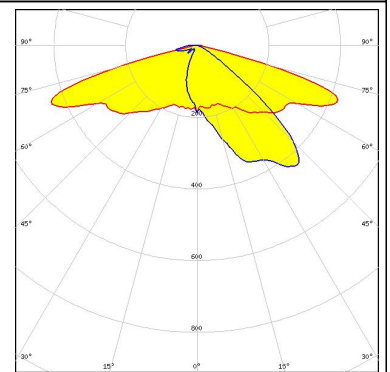

LED LUXEON M/MX  
 FWHM Asymmetric  
 Efficiency 78 %  
 Peak intensity 0.450 cd/lm  
 LEDs/each optic 1  
 Light colour White  
 Required components:

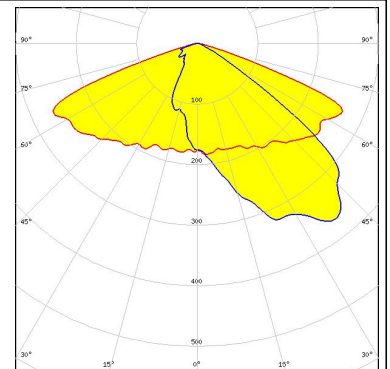

LED NVSxx19B/NVSxx19C  
 FWHM Asymmetric  
 Efficiency 92 %  
 Peak intensity 0.980 cd/lm  
 LEDs/each optic 1  
 Light colour White  
 Required components:

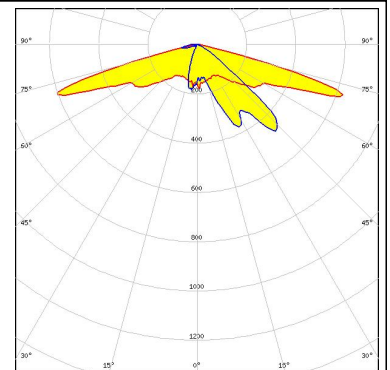

#### PHOTOMETRIC DATA (SIMULATED):

**OSRAM**  
Opto Semiconductors

LED	OSCONIQ P 7070
FWHM	Asymmetric
Efficiency	91 %
Peak intensity	0.647 cd/lm
LEDs/each optic	1
Light colour	White
Required components:	

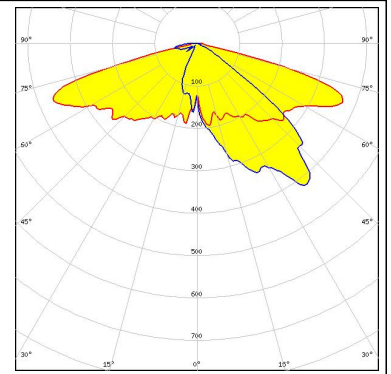

### GENERAL INFORMATION:

NOTE: The typical beam angle will be changed by different color, chip size and chip position tolerance. The typical total beam angle is the full angle measured where the luminous intensity is half of the peak value.

### MATERIALS:

As part of our continuous research and improvement processes, and to ensure the best possible quality and availability of our products, LEDiL reserves the right to change material grades without notice.

### PRODUCT DATA USER AGREEMENT AND DISCLAIMER:

The measured data in the provided downloadable LEDiL Product Datasheets and Mechanical 2D-Drawings is rounded and provided as reference for planning. LEDiL Oy's optical specifications have been verified by conducting performance testing of the products in accordance with the company's quality system. The reported data are averaged results of multiple measurements with typical variation. LEDiL Oy reserves the right to without prior notification make changes and improvements to its products.

LEDiL Oy assumes neither warranty, nor guarantee nor any other liability of any kind for the contents and correctness of the provided data. The provided data has been generated with highest diligence but the provided data may in reality not represent the complete possible variation range of all intrinsic parameters. Therefore, in certain cases a deviation from the provided data could occur.

LEDiL Oy reserves the right to undertake technical changes of its products without further notification which could lead to changes in the provided data. LEDiL Oy assumes no liability of any kind for the possible deviation from any provided data or any other damage resulting from the usage of the provided data.

The user agrees to this disclaimer and user agreement with the download or usage of the provided files.

#### LEDiL Oy

Joensuunkatu 13  
FI-24240 SALO  
Finland

#### LEDiL Inc.

228 West Page Street  
Suite D  
Sycamore IL 60178  
USA

#### Local sales and technical support

[www.ledil.com/  
where\\_to\\_buy](http://www.ledil.com/where_to_buy)

#### Shipping locations

Salo, Finland  
Hong Kong, China

#### Distribution Partners

[www.ledil.com/  
where\\_to\\_buy](http://www.ledil.com/where_to_buy)