

PCB VIEWING HOLES
 DETAIL A
 SCALE 5:1

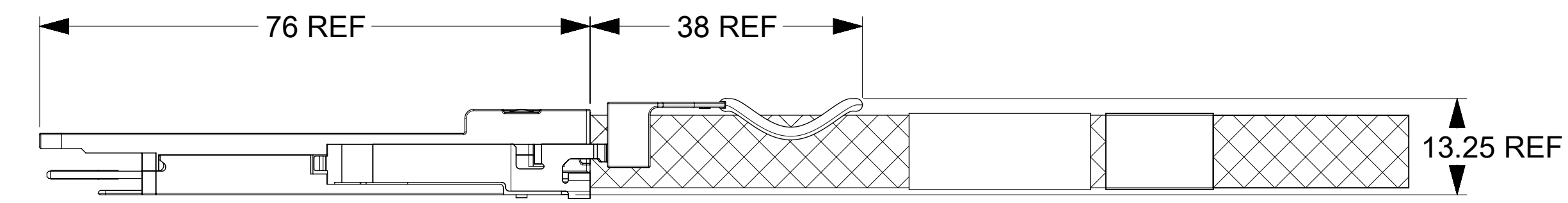
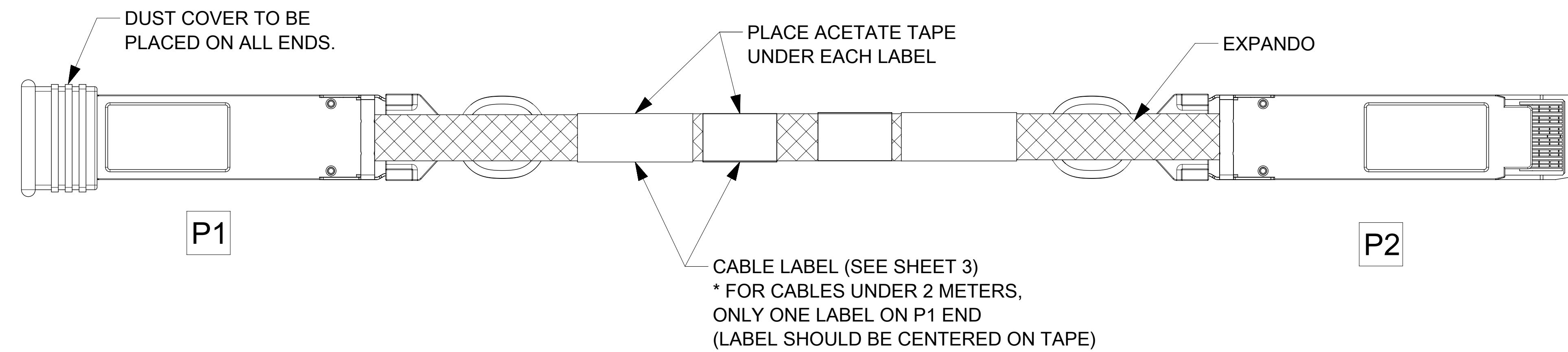

- NOTES:**
- CABLE LENGTH DEPENDS ON WIRE GAUGE, DATA RATE, AND HOST BOARD DRIVER CAPABILITIES
 - MATERIALS:**
 - BACKSHELLS - ZINC DIE CAST WITH BRIGHT NICKEL PLATING
 - DELATCH - STAINLESS STEEL WITH OVERMOLDED NYLON
 - RIVETS - STAINLESS STEEL
 - IMPEDANCE - 100 OHMS DIFFERENTIAL
 - BUNDLED CABLE RATED UL VW-1 FLAME PER UL STYLE 21479
 - EEPROM MAP AVAILABLE UPON REQUEST
 - RoHS COMPLIANT, NO EXEMPTIONS

FUNCTIONAL SYMBOLS $F_A = 0$ $F_C = 0$ $F_P = 0$ DIVISIONAL SYMBOLS	THIS DRAWING CONTAINS INFORMATION THAT IS PROPRIETARY TO MOLEX ELECTRONIC TECHNOLOGIES, LLC AND SHOULD NOT BE USED WITHOUT WRITTEN PERMISSION		DIMENSION UNITS: mm		SCALE: 2:1	CURRENT REV DESC: SHEET4 : ADDED LENGTH 2M 30AWG IN P/N TABLE																		
	GENERAL TOLERANCES (UNLESS SPECIFIED)		ANGULAR TOL $\pm 5.0^\circ$		EC NO: 677116		DRWN: ADITHK 2021/05/24 CHK'D: VITTAD 2021/09/09 APPR: MGARRISON 2021/09/10				QSFP-DD TO QSFP-DD 56G PASSIVE CABLE ASY													
	4 PLACES \pm		3 PLACES \pm		2 PLACES ± 0.13		1 PLACE ± 0.25		0 PLACES \pm		PRODUCT CUSTOMER DRAWING													
	DRAFT WHERE APPLICABLE MUST REMAIN WITHIN DIMENSIONS		THIRD ANGLE PROJECTION		DRAWING: D-SIZE		SERIES: 201591		INITIAL REVISION: DRWN: TPRATT 2016/11/08 APPR: CHIRSCHY 2016/11/10		DOCUMENT NUMBER: 2015911005		DOC TYPE: PSD	DOC PART: 000	REVISION: U									
DOCUMENT STATUS: P1	RELEASE DATE: 2021/09/10	01:01:00	MATERIAL NUMBER: SEE P/N TABLE	CUSTOMER: GENERAL MARKET	SHEET NUMBER: 1 OF 4	19	18	17	16	15	14	13	12	11	10	9	8	7	6	5	4	3	2	1

CABLE BEND RADIUS

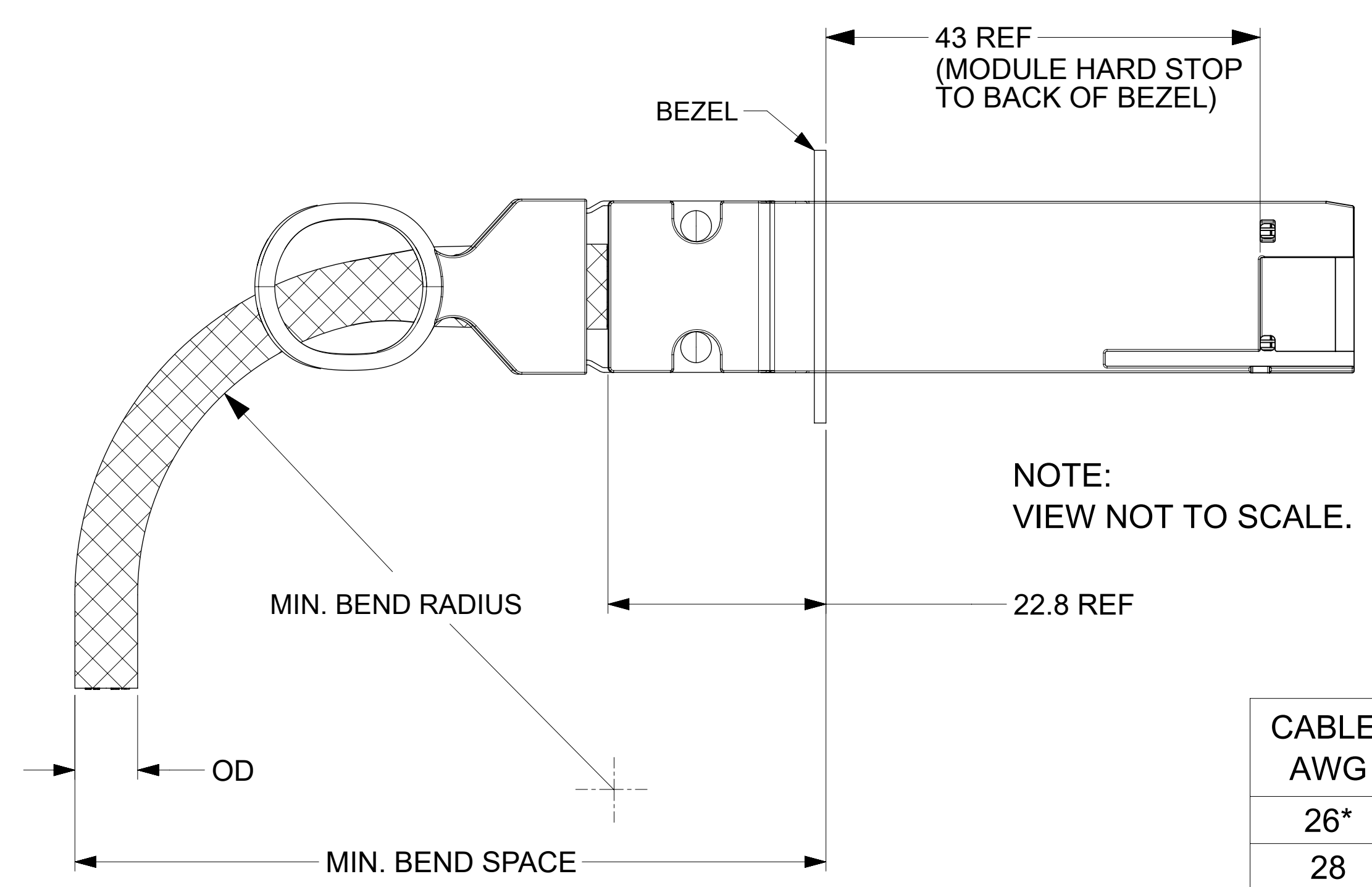

NOTE:
VIEW NOT TO SCALE.

CABLE AWG	OD (mm)	MIN BEND RADIUS (mm)	MIN BEND SPACE (mm)
26*	(13)	(65)	(101)
28	(11)	(55)	(89)
30	(9.4)	(45)	(77)

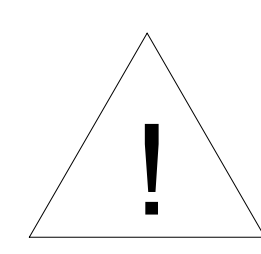

*MINIMUM BEND RADIUS PENDING QUALIFICATION. NUMBERS ABOVE ARE ESTIMATES AND SUBJECT TO CHANGE.

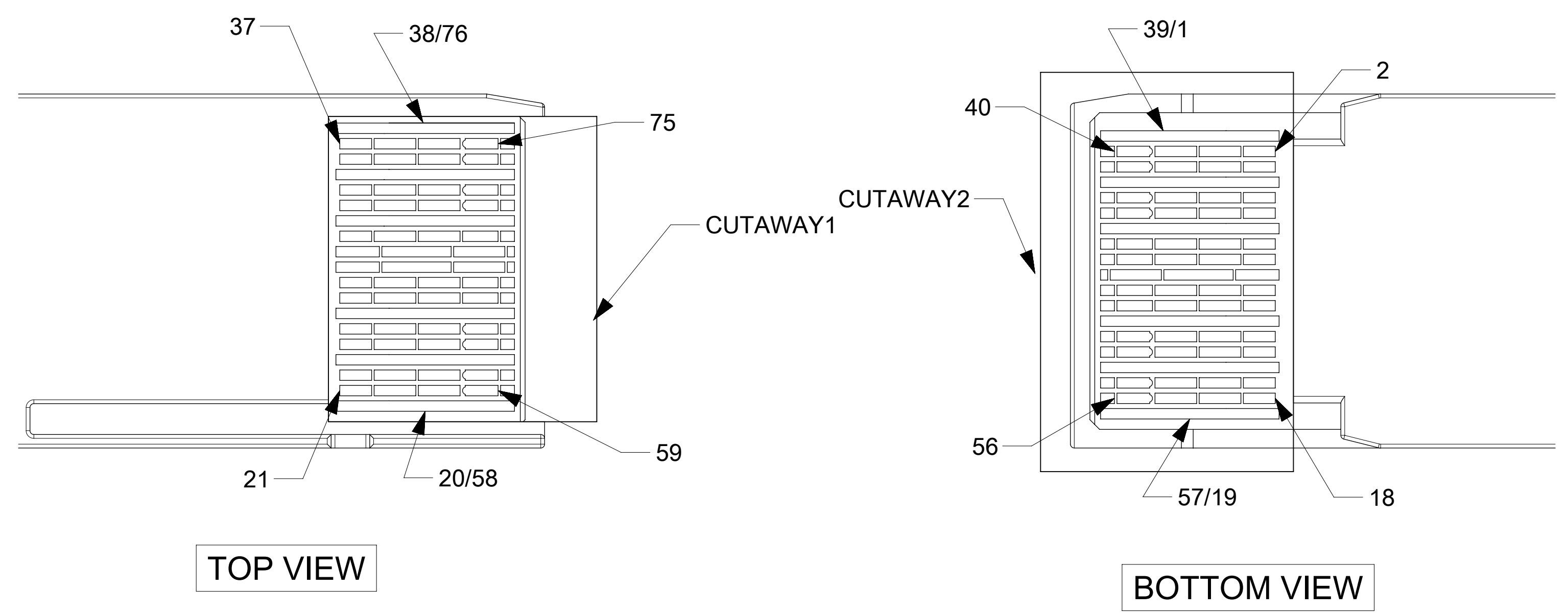

- NOTES:
- DC BLOCKING CAPS ON RECEIVE SIDE ONLY
 - CABLE COILED AND PACKAGED IN BEST FIT ESD BAG AND SEALED WITH ESD LABEL FOR SHIPPING

FUNCTIONAL SYMBOLS $F_A = 0$ $F_C = 0$ $F_D = 0$	DIMENSION UNITS: mm SCALE: 20:1		CURRENT REV DESC: SHEET4 : ADDED LENGTH 2M 30AWG IN P/N TABLE				
	GENERAL TOLERANCES (UNLESS SPECIFIED)		EC NO: 677116 DRWN: ADITHK 2021/05/24 CHK'D: VITTAD 2021/09/09 APPR: MGARRISON 2021/09/10			PRODUCT CUSTOMER DRAWING	
	ANGULAR TOL $\pm 5.0^\circ$		INITIAL REVISION: DRWN: TPRATT 2016/11/08 APPR: CHIRSCHY 2016/11/10				DOCUMENT NUMBER: 2015911005
	DRAFT WHERE APPLICABLE MUST REMAIN WITHIN DIMENSIONS		THIRD ANGLE PROJECTION	DRAWING: D-SIZE		SERIES: 201591	MATERIAL NUMBER: SEE P/N TABLE

WIRING DIAGRAM

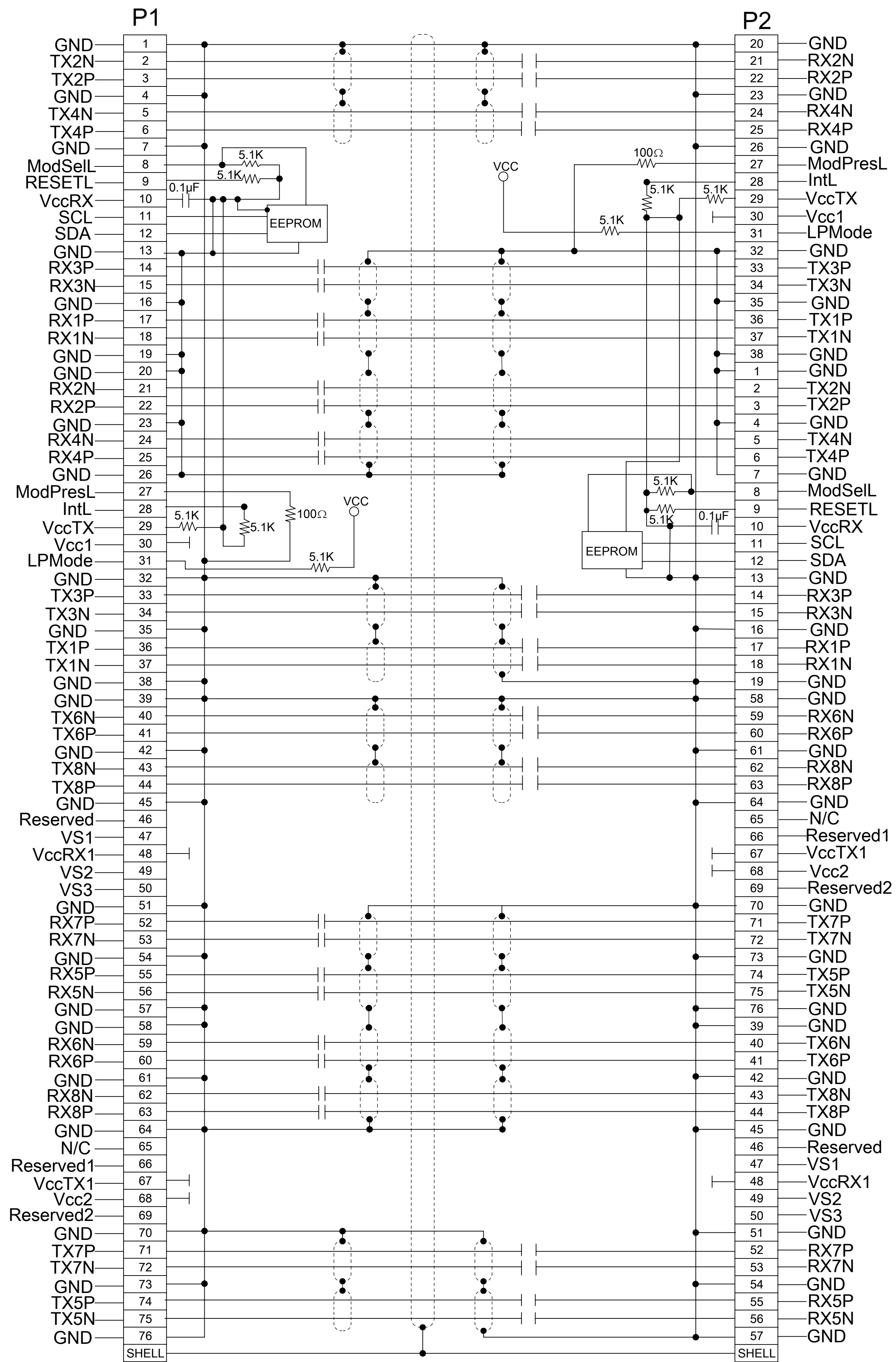

FUNCTIONAL SYMBOLS	THIS DRAWING CONTAINS INFORMATION THAT IS PROPRIETARY TO MOLEX ELECTRONIC TECHNOLOGIES, LLC AND SHOULD NOT BE USED WITHOUT WRITTEN PERMISSION		CURRENT REV DESC: SHEET4 : ADDED LENGTH 2M 30AWG IN P/N TABLE	
	DIMENSION UNITS	SCALE		
$\nabla_A = 0$	mm	1:1		
$\nabla_C = 0$	GENERAL TOLERANCES (UNLESS SPECIFIED)			
$\nabla_P = 0$	ANGULAR TOL $\pm 5.0^\circ$		EC NO: 677116	
DIVISIONAL SYMBOLS	4 PLACES	\pm	DRWN: ADITHK	2021/05/24
	3 PLACES	\pm	CHK'D: VITTAD	2021/09/09
	2 PLACES	± 0.13	APPR: MGARRISON	2021/09/10
	1 PLACE	± 0.25	INITIAL REVISION:	
0 PLACES	\pm	DRWN: TPRATT	2016/11/08	
DRAFT WHERE APPLICABLE MUST REMAIN WITHIN DIMENSIONS		THIRD ANGLE PROJECTION	DRAWING	SERIES
			D-SIZE	201591
DOCUMENT STATUS		P1	RELEASE DATE	2021/09/10 01:01:00
2015911005		PSD	000	U
SEE P/N TABLE		GENERAL MARKET	SHEET NUMBER 3 OF 4	

LABEL DETAILS

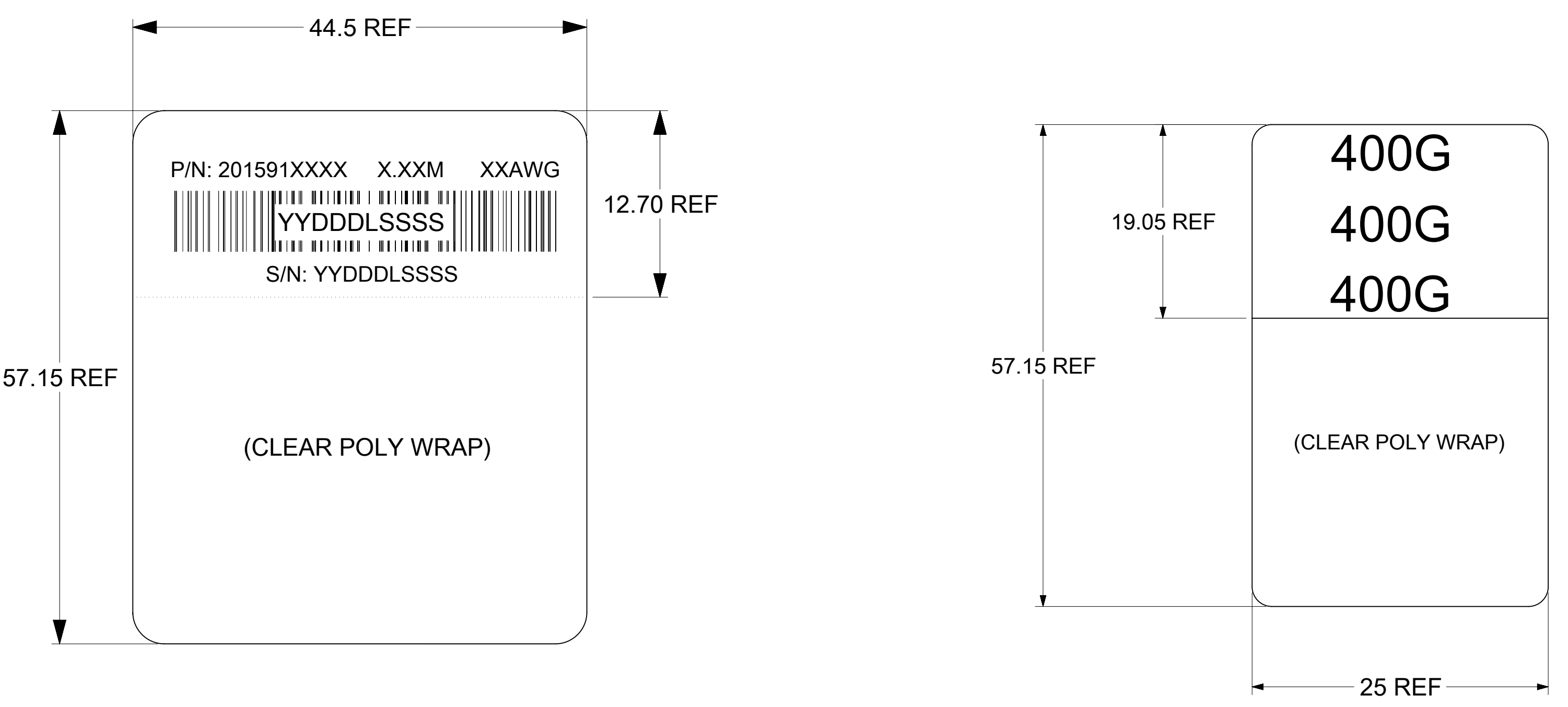

P/N: 201591XXXX - MOLEX PART NUMBER (SEE P/N TABLE)

X.XXM - CABLE LENGTH IN METERS (EXAMPLES - 0.5M, 1.0M, 1.5M)
SEE P/N TABLE FOR THE NUMBER OF DIGITS

XXAWG - CABLE SIZE IN AWG

S/N: YYDDLSSSS - SERIAL NUMBER
 YY = YEAR, THE LAST 2 DIGITS OF YEAR
 DDD = DAY OF THE YEAR
 L = LOCATION
 1 - USA
 2 - MEXICO
 3 - CHINA
 4 - PHILIPPINES
 SSSS = SERIAL NUMBER (0001-9999)

MOLEX P/N	LENGTH (M)	AWG
2015911005*	0.5M +/- 0.05M	30
2015911007	0.75M +/- 0.05M	30
2015911010	1.0M +/- 0.05M	30
2015911012	1.25M +/- 0.05M	30
2015911015	1.5M +/- 0.08M	30
2015911020	2.0M +/- 0.08M	30
2015913005*	0.5M +/- 0.05M	28
2015913010	1.0M +/- 0.05M	28
2015913012	1.25M +/- 0.05M	28
2015913015	1.5M +/- 0.08M	28
2015913017	1.75M +/- 0.08M	28
2015913020	2.0M +/- 0.08M	28
2015913025	2.5M +/- 0.08M	28
2015913252	2.5M +/- 0.08M	26
2015913027	2.75M +/- 0.08M	26
2015913030	3.0M +/- 0.08M	26

*CABLES MAY NOT MEET ALL IEEE 802.3cd 56G PAM4 PARAMETERS

FUNCTIONAL SYMBOLS $\nabla_A = 0$ $\nabla_C = 0$ $\nabla_D = 0$ DIVISIONAL SYMBOLS	THIS DRAWING CONTAINS INFORMATION THAT IS PROPRIETARY TO MOLEX ELECTRONIC TECHNOLOGIES, LLC AND SHOULD NOT BE USED WITHOUT WRITTEN PERMISSION		CURRENT REV DESC: SHEET4 : ADDED LENGTH 2M 30AWG IN P/N TABLE		
	DIMENSION UNITS	SCALE	GENERAL TOLERANCES (UNLESS SPECIFIED)		
	mm	1:1	ANGULAR TOL $\pm 5.0^\circ$		
	4 PLACES \pm		3 PLACES \pm		
3 PLACES \pm		2 PLACES ± 0.13		EC NO: 677116	PRODUCT CUSTOMER DRAWING DOCUMENT NUMBER: 2015911005 DOC TYPE: PSD DOC PART: 000 REVISION: U
2 PLACES ± 0.25		1 PLACE \pm		DRWN: ADITHK 2021/05/24	
0 PLACES \pm		DRAFT WHERE APPLICABLE MUST REMAIN WITHIN DIMENSIONS		DRWN: VITTAD 2021/09/09	
THIRD ANGLE PROJECTION		DRAWING		APPR: MGARRISON 2021/09/10	
		D-SIZE		DRWN: TPRATT 2016/11/08	
		SERIES		APPR: CHIRSCHY 2016/11/10	
		201591		MATERIAL NUMBER: SEE P/N TABLE	
				CUSTOMER: GENERAL MARKET	
				SHEET NUMBER: 4 OF 4	