

10689.0

PZK 3000/1/5,00/5,08 LG

**CRA<sup>®</sup>**

**US**

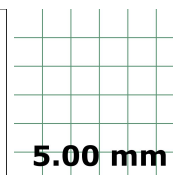
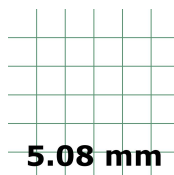
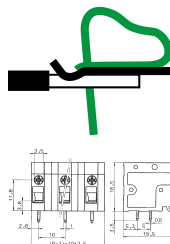

PCB terminal, Tension-spring connection, No. of poles: 1, Width: 7.2 mm, Colour: Pebble grey

## Business data

Packaging unit	50
Quantity unit	PC
Packaging type	Carton
Type of banding	Without
Weight per piece (not including packaging)	0.8 g
Weight per piece (including packaging)	1.22 g
Unit of weight	G
Customs number	85369010
Country of origin	TN
Prio-Article	10689.1

10689.0

PZK 3000/1/5,00/5,08 LG

---

## Technical data

---

### Dimensions

---

Length	14.2 mm
Length of the pin	4 mm
Width	7.2 mm
Width left	3.65 mm
Width right	3.55 mm
Height	12.9 mm
Drill hole diameter	1.1 mm
Diameter of connecting pin	0.7 mm
Pitch	5 mm

### Ratings

---

Rated voltage	250 V
Rated current	24 A
Rated cross-section	2.5 mm <sup>2</sup>
Rated impulse voltage	2 kV
Overvoltage category	III
Contamination degree	3

---

**10689.0**

**PZK 3000/1/5,00/5,08 LG**

---

## Technical data

---

### Connection data

---

Connection principle	Tension-spring connection
Connection type of PCB	Solder connection
Type of attachment to circuit board	Connecting contact
Angle of PCB/wire connection	45°/135° (slanted upwards)
No. of poles	1
Number of levels	1
Wire cross-section single-core (rigid) / stranded, min.	0.08 mm <sup>2</sup>
Wire cross-section single core (rigid)/stranded, max.	2.5 mm <sup>2</sup>
Wire cross-section stranded, min.	0.14 mm <sup>2</sup>
Wire cross-section stranded, max.	2.5 mm <sup>2</sup>
Wire cross-section stranded with wire-end ferrules, min.	0.14 mm <sup>2</sup>
Wire cross-section stranded with wire-end ferrules, max.	1.5 mm <sup>2</sup>
Wire cross-section AWG, min.	28
Wire cross-section AWG, max.	14
Stripping length	6 mm

### Materials

---

Insulation housing	Polyamide 6.6
Flammability class UL 94	V-0
Working temperature, min.	-30 °C
Working temperature, max.	105 °C
Tension spring	Stainless steel
Soldering lug	Copper alloy

---

10689.0

PZK 3000/1/5,00/5,08 LG

---

## Technical data

---

### Further technical data

---

Storage temperature, min.	-40 °C
Storage temperature, max.	105 °C
Insulation resistance	1*10 <sup>13</sup> Ohm x cm
Creepage-current resistance	CTI 600
Glow wire flammability index GWFI	GWFI 850
GWFI after-glow time	30 Sek.
Glow wire ignition temperature GWIT	GWIT 775 °C
GWIT exposure time	5 Sek.
Connection cycles, in compliance with standard	10
Recommended wave soldering temperature	265 °C
Recommended wave soldering duration, min.	3 Sek.
Recommended wave soldering duration, max.	4 Sek.

### Print

---

Colour	Pebble grey
--------	-------------

### Environmental Product Compliance

---

REACH Conform	yes
REACH Reference date	2021-07-08
REACH Candidate Substance Note	No
RoHS Conform	yes

10689.0

PZK 3000/1/5,00/5,08 LG

## Approvals

### cUL Recognized

cUL approval	CSA 22.2 No.158
cUL Usegroup B: rated voltage	300 V
cUL Usegroup B: rated current	15 A
cUL Usegroup D: rated voltage	300 V
cUL Usegroup D: rated current	10 A
cUL wire cross-section single-core (rigid) AWG, min.	28
cUL wire cross-section single-core (rigid) AWG, max.	14
cUL wire cross-section stranded AWG, min.	28
cUL wire cross-section stranded AWG, max.	14
cUL wire material	Cu
cUL Recognized	yes

### UL Recognized

UL approval	UL 1059
UL Usegroup B: rated voltage	300 V
UL Usegroup B: rated current	15 A
UL Usegroup D: rated voltage	300 V
UL Usegroup D: rated current	10 A
UL wire cross-section single-core (rigid) AWG, min.	28
UL wire cross-section single-core (rigid) AWG, max.	14
UL wire cross-section stranded AWG, min.	28
UL wire cross-section stranded AWG, max.	14
UL wire material	Cu
UL factory wiring	yes
UL field wiring	yes
UL Recognized	yes

**10689.0**

**PZK 3000/1/5,00/5,08 LG**

---

## Approvals

---

### VDE approval

---

VDE approval	DIN EN 60998
VDE approval granted	yes
VDE rated voltage	250 V
VDE rated current	24 A
VDE rated current wire cross-section rigid, max.	24 A
VDE rated current wire cross-section stranded, max.	24 A
VDE rated impulse voltage	2 kV
VDE wire cross-section rigid, min.	0.5 mm <sup>2</sup>
VDE wire cross-section rigid, max.	2.5 mm <sup>2</sup>
VDE wire cross-section stranded, min.	0.5 mm <sup>2</sup>
VDE wire cross-section stranded, max.	2.5 mm <sup>2</sup>
VDE overvoltage category	III
VDE contamination degree	3

---

10689.0

PZK 3000/1/5,00/5,08 LG

## Media

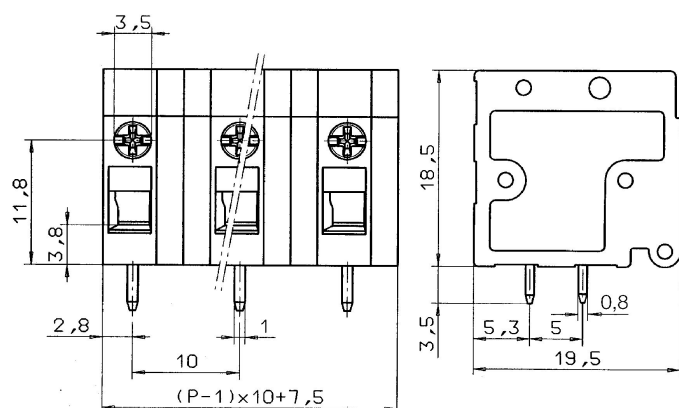
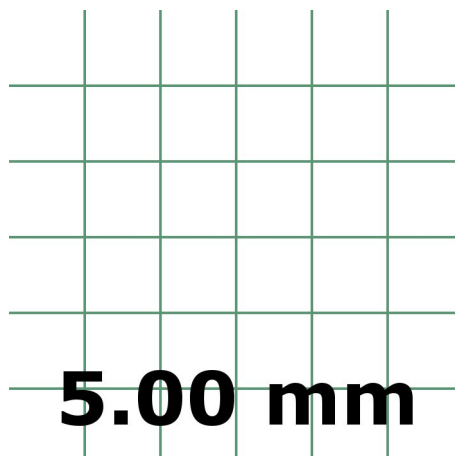
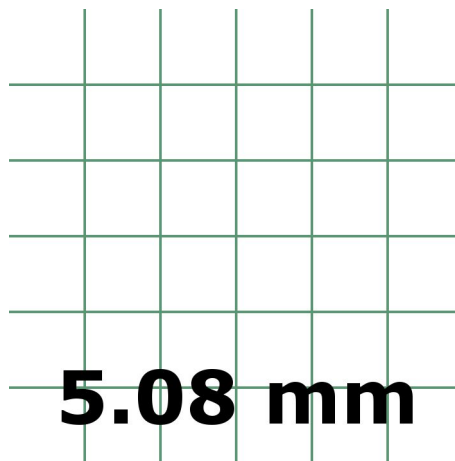
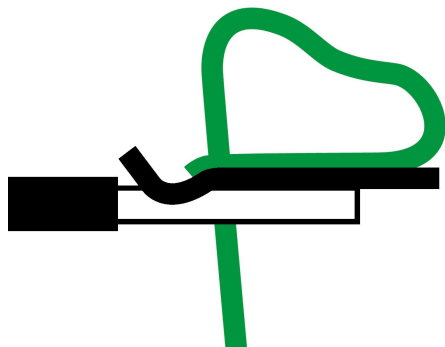

# Data sheet



10689.0

PZK 3000/1/5,00/5,08 LG

---

## Accessories

---