

R3100SD

REED INSTRUMENTS

Data Logging Conductivity/ TDS/Salt Meter



Instruction Manual

REED Instruments

1-877-849-2127 | info@reedinstruments.com | www.reedinstruments.com

Table of Contents

Introduction	3
Product Quality.....	3
Safety	4
Features	4
Included	4
Specifications.....	4-5
Instrument Description	6
Display Description	7
Operating Instructions.....	8-10
<i>Power ON/OFF</i>	8
<i>Selecting Measurement Modes</i>	8
<i>Conductivity Measurement</i>	8-9
<i>Manual Ranging</i>	9
<i>Zero Adjustment</i>	9
<i>TDS Measurement</i>	9
<i>Salt Measurement</i>	9-10
<i>Data Hold</i>	10
<i>Recording Maximum and Minimum Readings</i>	10
<i>Backlight</i>	10
Setup Mode	11-14
<i>Formatting the SD Card (Sd F)</i>	11-12
<i>Setting the Time and Date (dAtE)</i>	12
<i>Setting the Data Logging Sampling Rate (SP-t)</i>	12
<i>Enabling/Disabling Auto Power Off (PoFF)</i>	13
<i>Enabling/Disabling the Beeper (bEEP)</i>	13
<i>Setting Data Decimal Format (dEC)</i>	13
<i>Selecting the Temperature Unit of Measure (t-CF)</i>	14
<i>Setting CD Temperature Compensation Factor (PEr C)</i>	14
<i>ESC</i>	14
<i>Verify Set Time and Date</i>	14
<i>Verify Sampling Rate</i>	14

continued...

Data Logging	15-17
<i>Data Recording Modes</i>	15
<i>Manual Data Logging Mode</i>	15
<i>Automatic Data Logging Mode</i>	16
<i>Transferring Data from the SD Memory Card to a Computer</i>	16-17
<i>Calibration</i>	17
<i>Clearing Conductivity Calibration Data</i>	18
Data Stream Output	18-19
<i>3.5mm Terminal to RS-232 Serial Connection</i>	19
System Reset	19
Battery Replacement	19
Applications	20
Accessories and Replacement Parts	20
Frequently Asked Questions (FAQ's)	21
Product Care	21
Product Warranty	22
Product Disposal and Recycling	22
Product Support	22

Introduction

Thank you for purchasing your REED R3100SD Data Logging Conductivity/TDS/Salt Meter. Please read the following instructions carefully before using your instrument. By following the steps outlined in this manual your meter will provide years of reliable service.

Product Quality

This product has been manufactured in an ISO9001 facility and has been calibrated during the manufacturing process to meet the stated product specifications. If a certificate of calibration is required please contact the nearest authorized REED distributor or authorized Service Center. Please note an additional fee for this service will apply.

Safety

Never attempt to repair or modify your instrument. Dismantling your product, other than for the purpose of replacing batteries, may cause damage that will not be covered under the manufacturer's warranty. Servicing should only be provided by an authorized service center.

Features

- Measures conductivity, total dissolved solids (TDS) and salt levels in water
- Automatic temperature compensation
- Real time datalogger with integrated SD memory card (optional)
- User selectable sampling rate
- Easy-to-read backlit LCD display
- Data hold and Min/Max functions
- Tripod mount for long-term monitoring
- Low battery indicator and auto shut off

Included

- Probe
- Hard Carrying Case
- Batteries

Specifications

Conductivity

Measuring Range:	200 μ S/cm, 2mS/cm, 20mS/cm, 200mS/cm
Accuracy:	$\pm(2\%FS + 1 \text{ dgt})$
Resolution:	0.1 μ S, 0.001mS, 0.01mS, 0.1mS

TDS (Total Dissolved Solids)

Measuring Range:	200, 2000, 20,000, 200,000ppm
Accuracy:	$\pm(2\%FS + 1 \text{ dgt})$
Resolution:	0.1, 1, 10, 100 ppm

continued...

REED Instruments

1-877-849-2127 | info@reedinstruments.com | www.reedinstruments.com

Salinity

Measuring Range:	0 to 12% (% weight)
Accuracy:	±0.5% salt
Resolution:	0.01% salt
Temperature:	Measuring Range: 32 to 140°F (0 to 60°C) Accuracy: ±1.5°F (±0.8°C) Resolution: ±0.1°F (±0.1°C)

General Specifications

Display:	Dual Display, LCD
Backlit Display:	Yes
Data Hold:	Yes
Min:	Yes
Max:	Yes
Datalogging Capabilities:	Yes
Real-Time Clock and Date Stamp:	Yes
Sampling Rate:	Yes (1 second to 8 hours, 59 minutes and 59 seconds)
External Memory:	Yes, expandable up to 16GB with SD card (optional)
Auto Shut-off:	Yes (after 10 minutes/off)
Kick Stand:	Yes
Tripod Mountable:	Yes
Low Battery Indicator:	Yes
Power Supply:	6 x AA batteries or AC Adapter (optional)
Data Output:	Yes (RS-232)
Battery Life:	Sampling Time Dependent
Product Certifications:	CE
Operating Temperature:	Meter: 32 to 122°F (0 to 50°C) Probe: 32 to 140°F (0 to 60°C)
Storage Temperature:	14 to 140°F (-10 to 60°C)
Operating Humidity Range:	10 to 80%
Dimensions:	7 x 2.7 x 1.9" (177 x 68 x 45mm)
Weight:	1.1lbs (515g)

Instrument Description

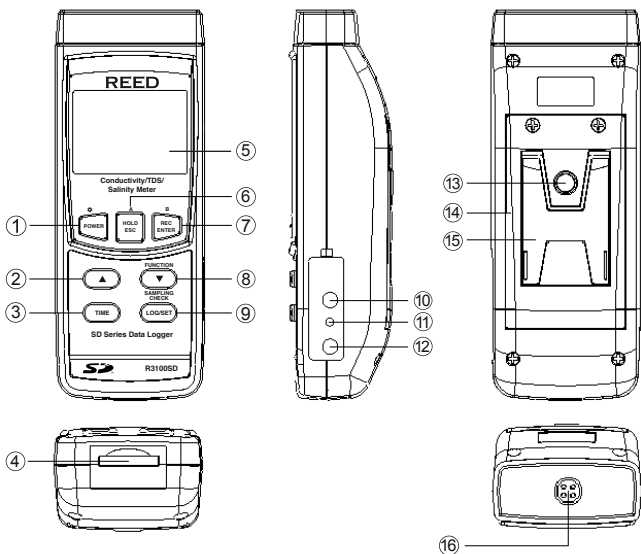

1. POWER/Backlight Button
2. Up Button
3. TIME Button
4. SD Card Slot
5. LCD Display
6. HOLD/ESC/A Button
7. REC/ENTER/B Button
8. Down/FUNCTION Button
9. LOG/SET/SAMPLING CHECK Button

10. RS-232 Output Jack
11. Reset Pin
12. Power Adapter Input Jack
13. Tripod Mounting Screw
14. Battery Cover
15. Kickstand
16. Probe Input Jack

REED Instruments

1-877-849-2127 | info@reedinstruments.com | www.reedinstruments.com

Display Description

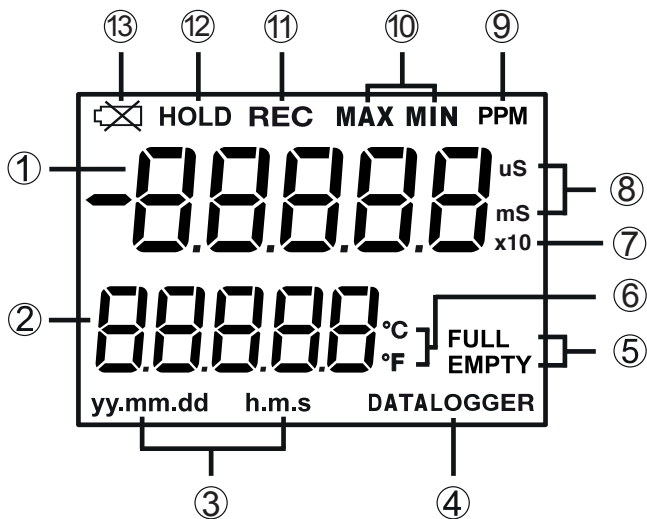

- | | |
|---|--|
| 1. Measurement Reading Indicator | 8. Conductivity Measurement Indicator |
| 2. Date & Time Values/
Temperature Measurement Reading | 9. Parts per million Measurement Indicator |
| 3. Date/Time Stamp | 10. Maximum and Minimum Indicators |
| 4. Data Logging Status Indicator | 11. Record Mode Indicator |
| 5. SD Card Status Indicator | 12. Data Hold Indicator |
| 6. Temperature Unit of Measure | 13. Low Battery Indicator |
| 7. PPM Multiplication Range Indicator | |

Operating Instructions

Power ON/OFF

Turn the meter on by pressing the **POWER** button. To turn the meter off, press, hold and release the **POWER** button for 2 seconds.

Note: This meter can be powered by either six (6) "AA" batteries or AC adapter (sold separately).

Selecting Measurement Modes

The R3100SD offers 3 measurement modes:

- Conductivity
 - Total Dissolved Solids
 - Salinity (Salt)
1. When the meter is on, press the ▲ button to toggle between "Cd" for conductivity measurements, "TDS" for total dissolved solids measurements & "SALT" for salt measurements.
 2. Release the ▲ button to confirm selection.

Note: At start up, the meter's default settings are:

- Display Unit: Conductivity
- Temperature Unit: °C
- Temp. Compensation Factor: 2.0% per °C
- Auto range: ON
- Auto power off: ON
- Datalogger Sampling Time: 2 seconds

Conductivity Measurement

1. Connect the conductivity probe into the input jack.
2. Select "Cd" function (see *Selecting Measurement Modes* for details).
3. Hold the probe handle and fully immerse the probe sensor into the solution under test.
4. Shake the probe to let the probe's internal air bubble drift out from under the sensing head.

continued...

5. The top of the LCD display will indicate the conductivity mS (μ S) value while the lower part of the LCD will display the solution temperature value.

Note: The zero adjustment function can only be used when the measured value is less than 10 digits.

Manual Ranging

Press the Function button to toggle between the ranges 200 μ S/cm, 2mS/cm, 20mS/cm, 200mS/cm and Auto Range.

Zero Adjustment

Follow the steps below if the display does not indicate a zero value when the probe is not immersed in any solution.

1. Press and hold the ▲ button for approx. 10 seconds.
2. When completed, the display will flash "CAL" and indicate a zero value.

Note: The Zero function is only valid for the 200 μ S range and not when the zero value is <2.0 μ S.

TDS Measurement

1. Connect the conductivity probe into the input jack.
2. Select "tdS" function (see *Selecting Measurement Modes* for details).
3. Hold the probe handle and fully immerse the probe sensor into the solution under test.
4. Shake the probe to let the probe's internal air bubble drift out from under the sensing head.
5. The top of the LCD display will indicate the total dissolved solids value while the lower part of the LCD will display the solution temperature value.

Salt Measurement

1. Connect the conductivity probe into the input jack.
2. Select "SALT" function (see *Selecting Measurement Modes* for details).
3. Hold the probe handle and fully immerse the probe sensor into the solution under test.

continued...

4. Shake the probe to let the probe's internal air bubble drift out from under the sensing head.
5. The LCD display will indicate the salt value in % of weight.

Data Hold

1. While taking a measurement, press the **HOLD** button to freeze the current readings on the display.
2. While in this mode a HOLD symbol will appear.
3. Press the **HOLD** button again to resume normal operation.

Note: When the Data Hold feature is active all buttons except the **POWER** button are disabled.

Recording Maximum and Minimum Readings

1. Press the **REC** button to enter recording mode as indicated by "REC" on the LCD. The meter will now begin recording maximum and minimum readings.
2. While in recording mode;
 - A) Press the **REC** button once and the maximum value will appear on the display as indicated by "REC MAX".
 - B) Press the **REC** button again and the minimum value will appear on the display as indicated by "REC MIN".
 - C) To exit recording mode and resume normal operation, press and hold the **REC** button for two seconds.

When in recording mode the **POWER** button is disabled and the meter cannot be turned off.

Backlight

After powering the meter ON, the LCD Backlight will turn on automatically. Press the BACKLIGHT button to turn the LCD Backlight on or off.

Setup Mode

1. Press and hold the **SET** button for 2 seconds to enter Setup Mode.
2. Press the **SET** button continuously to scroll through the following parameters.

Parameter	Description
Sd F	Format the SD memory card
dAtE	Set the time and date
SP-t	Set the data logging sampling rate
PoFF	Enable or disable the auto-power off function
bEEP	Turn the beeper on or off
dEC	Set the decimal format (USA (20.00) or European (20,00))
t-CF	Select the temperature unit of measure (°C or °F)
PEr C	Set Conductivity temperature compensation factor
ESC	Exit Setup mode

3. Once the appropriate parameter has been selected, follow the instructions below.

Formatting the SD Card (Sd F)

Follow steps 1 through 4 when "Sd F" appears on the LCD.

1. Press the ▲ and ▼ buttons to select "YES" to format the card. Select "NO" to abort.
2. Press the **ENTER** button to confirm selection.
3. Press the **ENTER** button again to re-confirm.
4. The meter will format the SD card and automatically return to the Setup menu when formatting is complete.

continued...

Note: At any time, you can press the **ESC** button to exit the Setup mode and resume normal operation. It is recommended that new SD cards should be formatted prior to first use. If the formatting process fails or if no card is inserted, the meter will display:

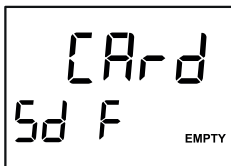

Setting the Time and Date (dAtE)

Follow steps 1 through 4 when "dAtE" appears on the LCD.

1. Press the ▲ and ▼ buttons to adjust the year as indicated by "YY."
2. Press the **ENTER** button to confirm selection.
3. Repeat steps 1 and 2 for month, day, hour, minute and seconds as indicated by (mm/dd/h/m/s).
4. Press the **SET** button to save the time stamp and skip to next parameter.

Note: At any time, you can press the **ESC** button to exit the Setup mode and resume normal operation. The internal clock will keep accurate time when the meter is powered off. When new batteries are installed the clock will have to be reset.

Setting the Data Logging Sampling Rate (SP-t)

Follow steps 1 through 4 when "SP-t" appears on the LCD.

1. The sampling rate can be set from '0' seconds (manual log mode only) up to 8 hours, 59 minutes and 59 seconds.
2. Press the ▲ and ▼ buttons to adjust the required sampling rate by hours, minutes or seconds as indicated by (h/m/s).
3. Press the **ENTER** button to confirm each selection.
4. Press the **SET** button to save the selected sampling rate and skip to next parameter.

Note: At any time, you can press the **ESC** button to exit the Setup mode and resume normal operation.

continued...

Enabling/Disabling Auto Power Off (PoFF)

Follow steps 1 through 3 when "PoFF" appears on the LCD.

1. Press the ▲ and ▼ buttons to select between YES (enabled) or NO (disabled). With the Auto Power OFF feature enabled, the meter will automatically switch OFF after 10 minutes of inactivity to preserve battery life.
2. Press the **ENTER** button to confirm selection.
3. Press the **SET** button to save and skip to next parameter.

Note: At any time, you can press the **ESC** button to exit the Setup mode and resume normal operation.

Enabling/Disabling the Beeper (bEEP)

Follow steps 1 through 3 when "bEEP" appears on the LCD.

1. Press the ▲ and ▼ buttons to select between ON (enabled) or OFF (disabled).
2. Press the **ENTER** button to confirm selection.
3. Press the **SET** button to save and skip to next parameter.

Note: At any time, you can press the **ESC** button to exit the Setup mode and resume normal operation.

Setting Data Decimal Format (dEC)

Numeric formats vary in different countries. By default the meter is set to bASIC mode where a decimal point is used to separate units, (i.e. 20.00). The European format uses a comma (i.e. 20,00) to separate units. To change this setting, follow steps 1 through 3 when "dEC" appears on the LCD.

1. Press the ▲ and ▼ buttons to select between bASIC and Euro.
2. Press the **ENTER** button to confirm selection.
3. Press the **SET** button to save and skip to next parameter.

Note: At any time, you can press the **ESC** button to exit the Setup mode and resume normal operation.

continued...

Selecting the Temperature Unit of Measure (t-CF)

Follow steps 1 through 3 when "t-CF" appears on the LCD.

1. Press the ▲ and ▼ buttons to select to select between °C and °F.
2. Press the **ENTER** button to confirm selection.
3. Press the **SET** button to save and skip to next parameter.

Note: At any time, you can press the **ESC** button to exit the Setup mode and resume normal operation.

Setting CD Temperature Compensation Factor (PEr C)

This function is only for the Conductivity (TDS) mode and is intended to adjust the probe's temperature compensation value in % per °C. Follow steps 1 through 3 when "PEr C" appears on the LCD.

1. Press the ▲ and ▼ buttons to select the desired temperature compensation. The default value is 2% per °C.
2. Press the **ENTER** button to confirm selection.
3. Press the **SET** button to save and skip to next parameter.

Note: At any time, you can press the **ESC** button to exit the Setup mode and resume normal operation.

ESC

Press the **ESC** button when "ESC" appears on the LCD to exit the Setup mode and resume normal operation.

Verify Set Time and Date

During normal operation, press the **TIME** button once to display the hour, minute, seconds. Press the button again to display the year, month and day.

Verify Sampling Rate

During normal operation, press the **SAMPLING CHECK** button to view the selected sampling rate.

Data Logging

Data Recording Modes

Manual Data Logging: Press the **LOG** button to manually log up to 99 readings on a SD memory card (see *Manual Data Logging Mode* for full setup instructions).

Automatic Data Logging: Setup the meter parameters in order to automatically log data on a SD memory card. The number of data points is limited by the size of the memory card.

Note: It is recommended to use a class 4 SDHC memory card between 1Gb and 16Gb. Insert the SD memory card in the slot at the bottom of the meter. The card must be inserted with the label side facing the rear of the meter.

Manual Data Logging Mode

In manual mode, the **LOG** button is pressed to manually log a reading on the inserted SD card at any time. In order to setup the meter for manual data logging, follow steps 1 through 7 below.

1. Set the data logging sampling rate to "0" seconds (see *Setting the Data Logging Sampling Rate* section for details).
 2. Press the **REC** button and "REC" will appear on the LCD.
 3. Press the **LOG** button to enter manual data logging function as indicated by "DATALOGGER".
 4. The meter will also display P-X (X = memory position number between 1 and 99).
 5. Press the **▲** and **▼** buttons to select one of the 99 data memory positions in which to record.
 6. Press the **LOG** button to save a reading to memory. 'DATALOGGER' will flash each time a data point is stored.
- Note:** If a card is not inserted or the card is defective, the meter will flash "EMPTY". In this case, power the meter OFF and try again with another SD memory card or verify that the card is correctly inserted.
7. To exit manual data logging mode, press and hold the **REC** button 2 seconds to resume normal operation.

continued...

Automatic Data Logging Mode

In automatic mode the desired data logging sampling rate can be set between 1 second to 8 hours, 59 minutes and 59 seconds prior to recording (see *Setting the Data Logging Sampling Rate* section for details). In order to setup the meter for automatic data logging, follow steps 1 through 5 below.

1. Press the **REC** button and "REC" will appear on the LCD.
2. Press the **LOG** button to enter automatic data logging function as indicated by "DATALOGGER".

Note: If a card is not inserted or the card is defective, the meter will display "EMPTY DATALOGGER". In this case, power the meter OFF and try again with another SD memory card or verify that the card is correctly inserted.

3. The "DATALOGGER" icon will appear on the LCD and will flash every time a reading is stored.
4. To pause the data logging session, press the **LOG** button and "DATALOGGER" will stop flashing. To resume, press the **LOG** button again.
5. To end the current data logging session, press and hold the **REC** button for 2 seconds.

Transferring Data from the SD Memory Card to a Computer

1. While the meter is powered Off, remove the SD memory card from the SD card slot.
2. Insert the SD memory card into the computer.
3. Open the file(s) with Excel. See sample below:

Position	Date	Time	Ch1_Value	Ch1_Unit	Ch2_Value	Ch2_unit
1	19-07-10	0:01:02	0.419	mS	21.7	Degree_C
2	19-07-10	0:01:04	10	mS	25	Degree_C
3	19-07-10	0:01:10	0.5	mS	21.7	Degree_C
4	19-07-10	0:01:10	0.418	mS	21.7	Degree_C
5	19-07-10	0:01:12	0.419	mS	21.7	Degree_C
6	19-07-10	0:01:14	10	mS	25	Degree_C
7	19-07-10	0:01:16	0.419	mS	21.7	Degree_C
8	19-07-10	0:01:18	0.419	mS	21.7	Degree_C
9	19-07-10	0:01:20	10	mS	25	Degree_C
10	19-07-10	0:01:22	0.419	mS	21.7	Degree_C
11	19-07-10	0:01:24	0.419	mS	21.7	Degree_C
12	19-07-10	0:01:26	0.419	mS	21.7	Degree_C

continued...

REED Instruments

1-877-849-2127 | info@reedinstruments.com | www.reedinstruments.com

The raw data can be used to create a graph in Excel. See sample below:

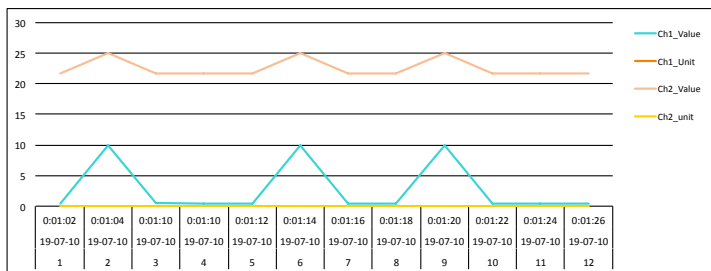

Calibration

1. Prepare the optional standard conductivity solution.
2. Connect the conductivity probe into the input jack.
3. Hold the probe handle and fully immerse the probe sensor into the solution under test.
4. Shake the probe to let the probe's internal air bubble drift out from under the sensing head.
5. The LCD display will indicate the conductivity value.
6. Press the "A" and "B" buttons simultaneously to enter calibration mode.
7. The LCD display will indicate the symbols "Cd" and "CAL".
8. Press the **ENTER** button and the measuring value will appear on both the upper and lower display.
9. Use the ▲ and ▼ buttons to adjust the upper display value to match the standard conductivity value.
10. Press the **ENTER** button to save the calibration data and resume normal operation.

Note: For single point calibration, use the 2mS/cm range (1.413mS Cal.). For multi-point calibration use the 2mS/cm range (1.413mS Cal.) first, followed by the other ranges (2mS/cm, 20mS/cm, 200mS/cm) if required.

continued...

REED Instruments

1-877-849-2127 | info@reedinstruments.com | www.reedinstruments.com

Clearing Conductivity Calibration Data

1. While under normal operation, press the "A" and "B" buttons simultaneously to enter calibration mode.
2. The LCD display will indicate the symbols "Cd" and "CAL".
3. Press the ▲ and ▼ buttons until "CLr" appears on the display.
4. Press the **ENTER** button to confirm and erase all calibration data.
5. The display will continuously blink while the calibration data is being erased.
6. When complete, the meter will resume normal operation.

Data Stream Output

Using Terminal application, a data stream can be viewed from the RS-232 output, connect RS-232/USB cable between the product and terminal/PC and use the following setting to view the data stream.

Terminal Settings:

- Bits per second: 9600
- Data bits: 8
- Parity: None
- Stop bits: 1

41131000001999 = Upper Value, +199.9 μ S

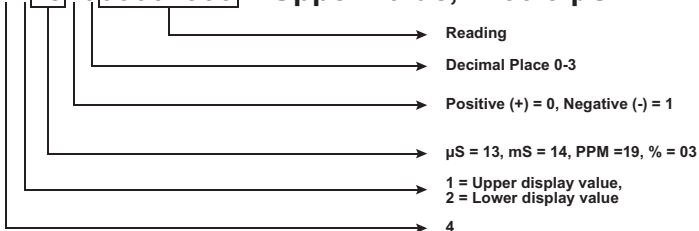

continued...

3.5mm Terminal to RS-232 Serial Connection

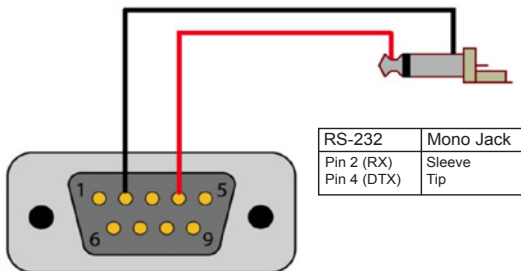

System Reset

If the meter becomes unresponsive or if the display freezes, the Reset Pin can be used to reset the instrument.

1. Use a paper clip or any similar small object to press the Reset Pin.
2. After pressing the Reset Pin, power the meter back up by holding the **POWER** button for 2 seconds.
3. If resetting the meter does not resolve the issue, please return the meter to the nearest authorized REED distributor or authorized Service Center for repair.

Battery Replacement

When the low battery icon  appears on the LCD, the batteries must be replaced.

1. Remove the two (2) Phillips screws on the back of the meter directly located above the top of the kickstand.
2. Remove the battery cover.
3. Replace 6 x "AA" batteries.
4. Secure the battery cover with the two (2) Phillips screws.

Applications

- Water conditioning
- General purpose pH measurement
- Aquariums
- Wastewater monitoring
- Beverage production

Accessories and Replacement Parts

R3100SD-PROBE Replacement Probe for R3100SD

R1430 Conductivity Standard Solution, 1413 μ s, 500ml

R1500 Tripod

RSD-ADP-NA Power Supply, 110V

RSD-ADP-EU Power Supply, 220V

CA-05A Soft Carrying Case

R8888 Deluxe Hard Carrying Case

SD-4GB 4GB Class 4 SDHC Memory Card

RSD-16GB 16GB Micro SD Memory Card w/ Adapter

Don't see your part listed here? For a complete list of all accessories and replacement parts visit your product page on www.REEDInstruments.com.

continued...

REED Instruments

1-877-849-2127 | info@reedinstruments.com | www.reedinstruments.com

Frequently Asked Questions (FAQ's)

I cannot turn off my meter, do you know why?

Often times, the meter cannot be turned off because it is in recording mode ("REC" mode). Make sure to exit that function by holding down the **REC** button before attempting to turn the meter off.

How long can I record for?

Battery life will depend on a number of factors:

- Quality of Battery
- Whether the beeper is ON or OFF
- Whether the backlight is ON or OFF
- Environmental Conditions during data logging

As a reference, using alkaline batteries with both the backlight and beeper on while automatic data logging at a 2 second sampling rate; the batteries lasted approx. 14 hours.

What is the length of the probe's cable? Can the probe handle and cable (excluding the probe plug) be fully immersed in a water source?

The length of the probe cable is approximately 3 feet.

Both the probe handle and cable can be fully immersed in a water source. Please note that where the cable meets the probe there is a rubber plug. After each use we recommend removing this plug to allow the excess water to drain.

Product Care

To keep your instrument in good working order we recommend the following:

- Store your product in a clean, dry place.
- Change the battery as needed.
- If your instrument isn't being used for a period of one month or longer please remove the battery.
- Clean your product and accessories with biodegradable cleaner. Do not spray the cleaner directly on the instrument. Use on external parts only.

Product Warranty

REED Instruments guarantees this instrument to be free of defects in material or workmanship for a period of one (1) year from date of shipment. During the warranty period, REED Instruments will repair or replace, at no charge, products or parts of a product that proves to be defective because of improper material or workmanship, under normal use and maintenance. REED Instruments total liability is limited to repair or replacement of the product. REED Instruments shall not be liable for damages to goods, property, or persons due to improper use or through attempts to utilize the instrument under conditions which exceed the designed capabilities. In order to begin the warranty service process, please contact us by phone at 1-877-849-2127 or by email at info@REEDInstruments.com to discuss the claim and determine the appropriate steps to process the warranty.

Product Disposal and Recycling



Please follow local laws and regulations when disposing or recycling your instrument. Your product contains electronic components and must be disposed of separately from standard waste products.

Product Support

If you have any questions on your product, please contact your authorized REED distributor or REED Instruments Customer Service by phone at 1-877-849-2127 or by email at info@REEDInstruments.com.

Please visit www.REEDInstruments.com for the most up-to-date manuals, datasheets, product guides and software.

*Product specifications subject to change without notice.
All rights reserved. Any unauthorized copying or reproduction of this manual is strictly prohibited without prior written permission from REED Instruments.*

REED Instruments

1-877-849-2127 | info@reedinstruments.com | www.reedinstruments.com

REED INSTRUMENTS

TEST & MEASURE WITH CONFIDENCE



Over 200 portable test and
measurement instruments

Access our
Product Catalog



REED Instruments

1-877-849-2127 | info@reedinstruments.com | www.reedinstruments.com

REED INSTRUMENTS

TEMPERATURE
& HUMIDITY



SOUND



MOISTURE



AIR VELOCITY



ELECTRICAL



REED Instruments

1-877-849-2127 | info@reedinstruments.com | www.reedinstruments.com