

R2450SD

REED INSTRUMENTS

Data Logging Thermometer



Instruction Manual

REED Instruments

1-877-849-2127 | info@reedinstruments.com | www.reedinstruments.com

Table of Contents

Introduction	3
Product Quality.....	3
Safety	4
Features.....	4
Included.....	4
General Specifications	5
Range Specification	6
Accuracy Specifications.....	6-7
Instrument Description	8
Display Description	9
Operating Instructions.....	10-12
<i>Power ON/OFF</i>	10
<i>Temperature Modes</i>	10
<i>Thermocouple Measurement Mode</i>	10
<i>RTD (Pt100 Ohm) Measurement Mode</i>	10
<i>Measuring the Difference Between Two Measurements (T1-T2)</i>	11
<i>Data Hold</i>	11
<i>Recording Maximum and Minimum Readings</i>	11-12
<i>Backlight</i>	12
Setup Mode.....	12-14
<i>Setting the Time and Date (dAtE)</i>	13
<i>Setting the Data Logging Sampling Rate (SP-t)</i>	13
<i>Enabling/Disabling Auto Power Off (PoFF)</i>	13
<i>Enabling/Disabling the Beeper (bEEP)</i>	13-14
<i>Setting Data Decimal Format (dEC)</i>	14
<i>Formatting the SD Card (Sd F)</i>	14

continued...

<i>Selecting the Temperature Unit of Measure (t-CF)</i>	14
<i>Verify Set Time, Date and Sampling Rate</i>	14
Data Logging	15-17
<i>Data Recording Modes</i>	15
<i>Manual Data Logging Mode</i>	15
<i>Automatic Data Logging</i>	16
<i>Transferring Data from the SD Memory Card to a Computer</i>	16-17
Thermocouple Probe Offset Adjustment.....	17
RTD Probe Offset Adjustment.....	18
Data Stream Output	19
<i>3.5mm Terminal to RS-232 Serial Connection</i>	19
Battery Replacement.....	20
Applications.....	20
Accessories and Replacement Parts	20-21
FAQ's.....	21
Product Care	21
Product Warranty	22
Product Disposal and Recycling	22
Product Support.....	22

Introduction

Thank you for purchasing your REED R2450SD Data Logging Thermometer. Please read the following instructions carefully before using your instrument. By following the steps outlined in this manual your meter will provide years of reliable service.

Product Quality

This product has been manufactured in an ISO9001 facility and has been calibrated during the manufacturing process to meet the stated product specifications. If a certificate of calibration is required please contact the nearest authorized REED distributor or authorized Service Center. Please note an additional fee for this service will apply.

Safety

Never attempt to repair or modify your instrument. Dismantling your product, other than for the purpose of replacing batteries, may cause damage that will not be covered under the manufacturer's warranty. Servicing should only be provided by an authorized service center.

Features

- Displays up to 4 separate measurements simultaneously
- Accepts Type K, J, R, S, E, T thermocouples and RTD probes
- Temperature differential (T1-T2), Max/Min and Data hold functions
- User selectable °C, °F
- Real-time data logger with integrated SD memory card
- User selectable sampling rate from 1 to 3600 seconds
- Easy-to-read backlit LCD display
- Tripod mount for long-term monitoring
- Low battery indicator and auto shut off

Included

- Beaded Wire Probe
- Soft Carrying Case
- Batteries

General Specifications

Resolution:	0.1 or 1°F/°C
Type:	4-Channel Thermocouple, 2-Channel RTD
Response Time:	1x/second
Display:	Quad Display, LCD
Backlit Display:	Yes
Data Hold:	Yes
Min:	Yes
Max:	Yes
Differential Measurement (T1-T2):	Yes
Datalogging Capabilities:	Yes
Real-Time Clock and Date Stamp:	Yes
Selectable Sampling Rate:	Yes (1, 2, 5, 10, 30, 60, 120, 300, 600, 1800, 3600 seconds)
External Memory:	Yes, expandable up to 16GB with SD card (optional)
Auto Shut-off:	Yes (after 10 minutes/off)
Kick Stand:	Yes
Tripod Mountable:	Yes
Low Battery Indicator:	Yes
Power Supply:	6 x AA Batteries or AC Adapter (optional)
Data Output:	Yes (RS-232)
Product Certifications:	CE
Operating Temperature:	32 to 122°F (0 to 50°C)
Storage Temperature:	14 to 140°F (-10 to 60°C)
Operating Humidity Range:	Less than 85% RH
Dimensions:	7.0 x 2.7 x 1.8" (177 x 68 x 45mm)
Weight:	0.6lbs (268g)

Range Specifications

Thermocouple	Range	Resolution
Type K	-148 to 2372°F (-100 to 1300°C)	0.1°F (0.1°C) 1°F (1°C) ≥ 1000°
Type J	-148 to 2102°F (-100 to 1150°C)	0.1°F (0.1°C) 1°F (1°C) ≥ 1000°
Type T	-148 to 752°F (-100 to 400°C)	0.1°F (0.1°C)
Type E	-148 to 1652°F (-100 to 900°C)	0.1°F (0.1°C) 1°F ≥ 1000°
Type R	32 to 3092°F (0 to 1700°C)	1°F (1°C)
Type S	32 to 2732°F (0 to 1500°C)	1°F (1°C)

RTD	Range	Resolution
Pt100 Ohm	-327.9 to 1562°F (-199.9 to 850°C)	0.1°F (0.1°C) 1°F ≥ 1000°

Note: RTD Pt100 Ohm is an optional accessory (R2450SD-RTD)

Accuracy Specifications

Thermocouple	Accuracy
Type K	-148.0 to -58.1°F, ± (0.4% + 1.8°F) -58.0 to 999.9°F, ± (0.4% + 1°F) 1000 to 2372°F, ± (0.4% + 2°F) -100.0 to -50.1°C, ± (0.4% + 1°C) -50.0 to 999.9°C, ± (0.4% + 0.5°C) 1000 to 1300°C, ± (0.4% + 1°C)

continued...

REED Instruments

1-877-849-2127 | info@reedinstruments.com | www.reedinstruments.com

Type J	-148.0 to -58.1°F, $\pm(0.4\% + 1.8^\circ\text{F})$ -58.0 to 999.9°F, $\pm(0.4\% + 1^\circ\text{F})$ 1000 to 2102°F, $\pm(0.4\% + 2^\circ\text{F})$ -100.0 to -50.1°C, $\pm(0.4\% + 1^\circ\text{C})$ -50.0 to 999.9°C, $\pm(0.4\% + 0.5^\circ\text{C})$ 1000 to 1150°C, $\pm(0.4\% + 1^\circ\text{C})$
Type T	-148.0 to -58.1°F, $\pm(0.4\% + 1.8^\circ\text{F})$ -58.0 to 752.0°F, $\pm(0.4\% + 1^\circ\text{F})$ -100.0 to -50.1°C, $\pm(0.4\% + 1^\circ\text{C})$ -50.0 to 400.0°C, $\pm(0.4\% + 0.5^\circ\text{C})$
Type E	-148.0 to -58.1°F, $\pm(0.4\% + 1.8^\circ\text{F})$ -58.0 to 999.9°F, $\pm(0.4\% + 1^\circ\text{F})$ 1000 to 1652°F, $\pm(0.4\% + 2^\circ\text{F})$ -100.0 to -50.1°C, $\pm(0.4\% + 1^\circ\text{C})$ -50.0 to 900.0°C, $\pm(0.4\% + 0.5^\circ\text{C})$
Type R	32 to 3092°F, $\pm(0.5\% + 5^\circ\text{F})$ 0 to 1700°C, $\pm(0.5\% + 3^\circ\text{C})$
Type S	32 to 2732°F, $\pm(0.5\% + 5^\circ\text{F})$ 0 to 1500°C, $\pm(0.5\% + 3^\circ\text{C})$

RTD	Range
Pt100 Ohm	-327.0 to 999.9°F, $\pm(0.4\% + 1.8^\circ\text{F})$ 1000 to 1562°F, $\pm(0.4\% + 2^\circ\text{F})$ -199.9 to 850.0°C, $\pm(0.4\% + 1^\circ\text{C})$

Note: Stated Thermocouple RTD accuracy values are specific to the meter. The accuracy of the input probe should be considered when calculating overall accuracy.

Instrument Description

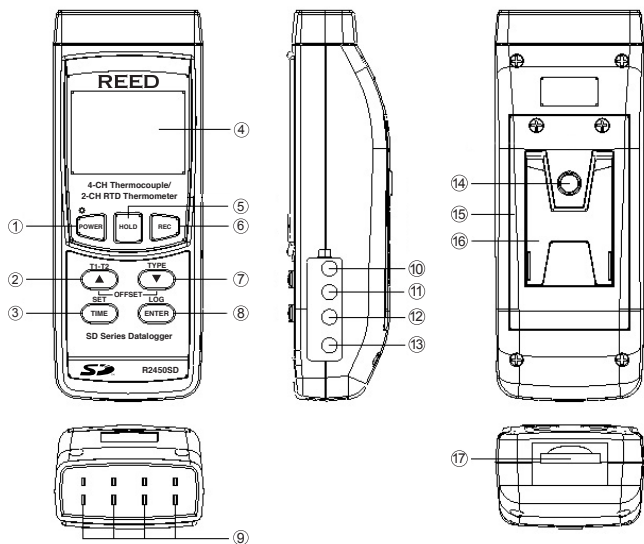

- | | |
|-------------------------------------|---------------------------|
| 1. POWER/Backlight Button | 10. PT1 (RTD) Input Jack |
| 2. Up/T1-T2 Button | 11. PT2 (RTD) Input Jack |
| 3. TIME/SET Button | 12. RS-232 Output Jack |
| 4. LCD Display | 13. Power Adapter Input |
| 5. HOLD Button | 14. Tripod Mounting Screw |
| 6. REC Button | 15. Battery Cover |
| 7. Down/TYPE Button | 16. Kickstand |
| 8. ENTER/LOG Button | 17. SD Card Slot |
| 9. Thermocouple Input Jacks (T1-T4) | |

REED Instruments

1-877-849-2127 | info@reedinstruments.com | www.reedinstruments.com

Display Description

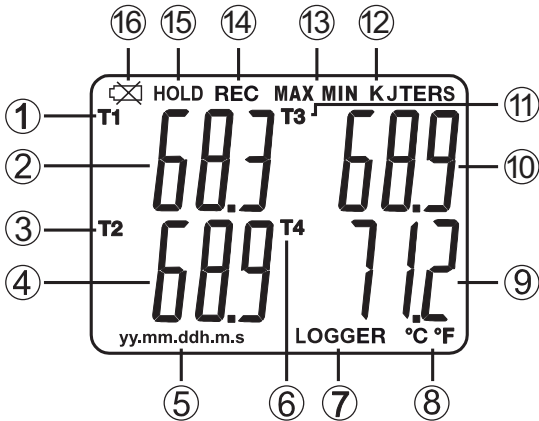

1. T1 (Channel 1) Thermocouple Input or PT1 RTD Input Indicator
2. Temperature Measurement for T1 Thermocouple or PT1 RTD Channel
3. T2 (Channel 2) Thermocouple Input or PT2 RTD Input Indicator
4. Temperature Measurement for T2 Thermocouple or PT2 RTD Channel
5. Date/Time Stamp
6. T4 (Channel 4) Thermocouple Input Indicator
7. Data Logging Status Indicator
8. Temperature Unit of Measure
9. Temperature Measurement for T4 Thermocouple Channel
10. Temperature Measurement for T3 Thermocouple Channel
11. T3 (Channel 3) Thermocouple Input
12. Thermocouple Input Type
13. Maximum and Minimum Indicator
14. Record Mode Indicator
15. Data Hold Indicator
16. Low Battery Indicator

Operating Instructions

Power ON/OFF

1. To turn the meter on or off press and hold the **POWER** button for 2 seconds.

Note: This meter can be powered by either 6 x "AA" batteries or an AC adapter (sold separately).

Temperature Modes

This meter offers a thermocouple mode (thermocouple Types K, J, T, E, R, or S) and a RTD mode (platinum 100 ohm).

Thermocouple Measurement Mode

1. Connect up to four (4) thermocouples to the input jacks located at the top of the meter, identified as T1 through T4.
2. Once one or more thermocouples are connected press and hold the **TYPE** button to scroll through the thermocouple types (K/J/T/E/R/S). Continue to hold the **TYPE** button until the desired type appears on the LCD and release to confirm selection.
3. The LCD will display the temperature values for the channels in use. If an input jack is not in use or the measurement is out of temperature range, the screen will display "- - - -".

RTD (Pt100 Ohm) Measurement Mode

1. Connect up to two (2) RTD probes (R2450SD-RTD) to the RTD input jacks labeled PT1 & PT2.
2. Once one or two RTD probes are connected press and hold the **TYPE** button to scroll through the temperature sensor types until "Pt" is displayed on the LCD. Release the **TYPE** button to confirm the selection.
3. The LCD will display the temperature values for the channels in use. If an input jack is not in use or the measurement is out of temperature range, the screen will display "- - - -".

continued...

Measuring the Difference Between Two Measurements (T1-T2)

1. Insert either two thermocouple probes in the T1 & T2 input jacks, or two RTD (Pt100 Ohm) probes in the PT1 & PT2 input jacks.
2. To view the temperature difference between the two thermocouple probes (T1-T2) or two RTD (PT100 Ohm) probes (PT1 & PT2), hold the "T1-T2" button for 2 seconds and release.

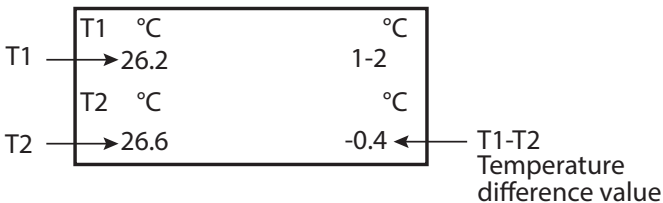

3. To resume normal operation, press and hold the "T1-T2" button for 2 seconds.

Data Hold

1. While taking a measurement, press the **HOLD** button to freeze the current measurement(s) on the display.
2. While in this mode a "HOLD" symbol will appear on the display.
3. Press the button again to resume normal operation.

Note: When the Data Hold feature is active all buttons except the **POWER** button are disabled.

Recording Maximum and Minimum Readings

1. Press the **REC** button to enter recording mode as indicated by "REC" on the LCD. The meter will now begin recording maximum and minimum readings.
2. While in recording mode;
 - A) Press the **REC** button once and the maximum value will appear on the display as indicated by "REC MAX".

continued...

- B) Press the **REC** button again and the minimum value will appear on the display as indicated by "REC MIN".
- C) To exit recording mode and resume normal operation, press and hold the **REC** button for two seconds.

When in recording mode the **POWER** button is disabled and the meter cannot be turned off.

Backlight

After powering the meter ON, the LCD Backlight will turn on automatically. Press the BACKLIGHT button to turn the LCD Backlight on or off.

Setup Mode

1. Press and hold the **SET** button for 2 seconds to enter Setup Mode.
2. Press the **SET** button continuously to scroll through the following parameters.

Parameter	Description
dAtE	Set the time and date
SP-t	Set the data logging sampling rate
PoFF	Enable or disable the auto-power off function
bEEP	Turn the beeper on or off
dEC	Set the decimal format (USA (20.00) or European (20,00))
Sd F	Format the SD memory card
t-CF	Select the temperature unit of measure (°C or °F)

3. Once the appropriate parameter has been selected, follow the instructions below.

Note: The meter will automatically exit out of the Setup mode if no key is pressed within 7 seconds.

continued...

Setting the Time and Date (dAtE)

1. Press the **ENTER** button when "dAtE" appears on the LCD.
2. Press the **▲** and **▼** buttons to adjust the year as indicated by "YY".
3. Press the **ENTER** button to confirm selection.
4. Repeat steps 2 and 3 for month, day, hour, minute and seconds as indicated by (mm/dd/h/m/s).
5. After each value has been selected and confirmed, the meter will automatically skip to the next parameter.

Note: At any time, you can press the **POWER** button to exit the setup mode and resume normal operation. The internal clock will keep accurate time when the meter is powered off. When new batteries are installed the clock will have to be reset.

Setting the Data Logging Sampling Rate (SP-t)

Follow steps 1 and 2 when "SP-t" appears on the LCD.

1. Press the **▲** and **▼** buttons to adjust the sampling rate between 0, 1, 2, 5, 10, 30, 60, 120, 300, 600, 1800, and 3600 seconds.
2. Press the **ENTER** button to confirm selection and skip to next parameter.

Note: At any time, you can press the **POWER** button to exit the setup mode and resume normal operation.

Enabling/Disabling Auto Power Off (PoFF)

Follow steps 1 and 2 when "PoFF" appears on the LCD.

1. Press the **▲** and **▼** buttons to select between ON (enabled) or OFF (disabled). With the Auto Power OFF feature enabled, the meter will automatically switch OFF after 10 minutes of inactivity to preserve battery life.
2. Press the **ENTER** button to confirm selection and skip to next parameter.

Note: At any time, you can press the **POWER** button to exit the setup mode and resume normal operation.

Enabling/Disabling the Beeper (bEEP)

Follow steps 1 and 2 when "bEEP" appears on the LCD.

1. Press the **▲** and **▼** buttons to select between ON (enabled) or OFF (disabled).
2. Press the **ENTER** button to confirm selection and skip to next parameter.

continued...

Note: At any time, you can press the **POWER** button to exit the setup mode and resume normal operation.

Setting Data Decimal Format (dEC)

Numeric formats vary in different countries. By default the meter is set to USA mode where a decimal point is used to separate units, (i.e. 20.00). The European format uses a comma (i.e. 20,00) to separate units. To change this setting, follow steps 1 and 2 when "dEC" appears on the LCD.

1. Press the **▲** and **▼** buttons to select between USA and Euro.
2. Press the **ENTER** button to confirm selection and skip to next parameter.

Note: At any time, you can press the **POWER** button to exit the setup mode and resume normal operation.

Formatting the SD Card (Sd F)

Follow steps 1 through 5 when "Sd F" appears on the LCD.

1. Press the **▲** and **▼** buttons to select "YES" to format the card. Select "NO" to abort.
2. Press the **ENTER** button to confirm selection.
3. Press the **ENTER** button again to re-confirm.
4. The meter will format the SD card while flashing "For-" and automatically return to the Setup menu when formatting is complete.
5. Press the **POWER** button to exit Setup mode and resume normal operation.

Note: It is recommended that new SD cards be formatted prior to first use. If the formatting process fails, the meter will display "Sd -E-".

Selecting the Temperature Unit of Measure (t-CF)

Follow steps 1 and 2 when "t-CF" appears on the LCD.

1. Press the **▲** and **▼** buttons to select between °C and °F.
2. Press the **ENTER** button to confirm selection.

Note: At any time, you can press the **POWER** button to exit the setup mode and resume normal operation.

Verify Set Time, Date and Sampling Rate

During normal operation press the **TIME** button to display the year, month, day, hour, minute, seconds and selected sampling rate.

Data Logging

Data Recording Modes

Manual Data Logging: Press the LOG button to manually log up to 99 readings on a SD memory card (see *Manual Data Logging Mode* for details).

Automatic Data Logging: Setup the meter parameters in order to automatically log data on a SD memory card. The number of data points is limited by the size of the memory card.

Note: It is recommended to use a class 4 SDHC memory card between 1Gb and 16Gb. Insert the SD memory card in the slot at the bottom of the meter. The card must be inserted with the label side facing the rear of the meter.

Manual Data Logging Mode

In manual mode, the LOG button is pressed to manually log a reading on the inserted SD card at any time. In order to setup the meter for manual data logging, follow steps 1 through 5 below.

1. Set the data logging sampling rate to "0" seconds (see *Setting the Data Logging Sampling Rate* section for details).
2. Press and hold the LOG button for 2 seconds at which point the lower portion of the LCD will display P-X (X = memory position number between 1 and 99).
3. Press the ▲ and ▼ buttons to select one of the 99 data memory positions in which to record.
4. Press the LOG button again to save a reading to memory. "LOGGER" will flash each time a data point is stored.
5. To exit manual data logging mode, press and hold the LOG button 2 seconds to resume normal operation.

continued...

Automatic Data Logging Mode

In automatic mode the desired data logging sampling rate is set to 1, 2, 5, 10, 30, 60, 120, 300, 600, 1800 or 3600 seconds prior to recording (see *Setting the Data Logging Sampling Rate* section for details). In order to setup the meter for automatic data logging, follow steps 1 through 5 below.

1. To begin a data logging session press and hold the LOG button for 2 seconds. The meter will scan for a SD memory card. If a card is not inserted or the card is defective, the meter will flash "Sd -E-" indefinitely. In this case, power the meter OFF and try again with another SD memory card.
2. The Logger icon will appear on the LCD and will continuously flash while in a data logging session.
3. To pause the data logging session press the LOG button and Logger will stop flashing. To resume press the LOG button again.
4. To end the current data logging session press and hold the LOG button for 2 seconds.

Transferring Data from the SD Memory Card to a Computer

1. While the meter is powered Off remove the SD memory card from the SD card slot.
2. Insert the SD memory card into the computer.
3. Open the file(s) with Excel. See sample below:

Place	Date	Time	Value	Unit	Value	Unit	Value	Unit	Value	Unit
1	7/10/2019	4:13:07	22.7	T1 KTemp C	22.7	T2 KTemp C	22.7	T3 KTemp C	24	T4 KTemp C
2	7/10/2019	4:13:37	35	T1 KTemp C	38	T2 KTemp C	36	T3 KTemp C	37	T4 KTemp C
3	7/10/2019	4:14:07	40.2	T1 KTemp C	39	T2 KTemp C	39	T3 KTemp C	44	T4 KTemp C
4	7/10/2019	4:14:37	60	T1 KTemp C	67	T2 KTemp C	63	T3 KTemp C	59	T4 KTemp C
5	7/10/2019	4:15:07	87	T1 KTemp C	92	T2 KTemp C	90	T3 KTemp C	85	T4 KTemp C
6	7/10/2019	4:15:37	102.5	T1 KTemp C	101.5	T2 KTemp C	104	T3 KTemp C	107	T4 KTemp C
7	7/10/2019	4:16:07	55.4	T1 KTemp C	52	T2 KTemp C	49	T3 KTemp C	46	T4 KTemp C
8	7/10/2019	4:16:37	80.2	T1 KTemp C	81	T2 KTemp C	87	T3 KTemp C	85	T4 KTemp C
9	7/10/2019	4:17:07	90	T1 KTemp C	90	T2 KTemp C	92	T3 KTemp C	92	T4 KTemp C
10	7/10/2019	4:17:37	42.7	T1 KTemp C	43	T2 KTemp C	42.7	T3 KTemp C	57	T4 KTemp C
11	7/10/2019	4:18:07	75	T1 KTemp C	78	T2 KTemp C	76	T3 KTemp C	75	T4 KTemp C

continued...

REED Instruments

1-877-849-2127 | info@reedinstruments.com | www.reedinstruments.com

The raw data can be used to create a graph in Excel. See sample below:

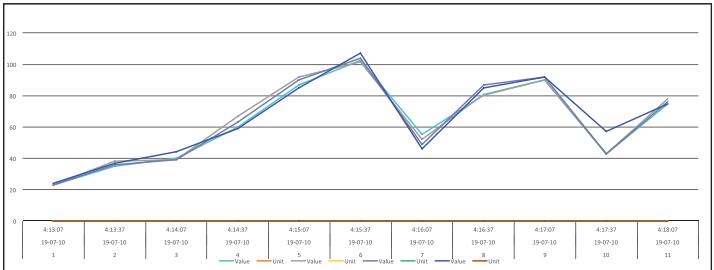

Thermocouple Probe Offset Adjustment

1. Select the desired thermocouple type.
2. Insert the thermocouple probe into the T1 (Channel 1) thermocouple input jack.
3. Press and hold the OFFSET buttons (both up and down arrows) for 2 seconds to enter setup.

Note: "Err" will appear if the selected input does not have a probe inserted.

4. The last measurement value will be displayed on the left side of the LCD, while the offset adjusted value will be displayed on the right as shown below.

SEt	oFS
23.7	23.7

5. Press the ▲ and ▼ buttons to adjust the offset value.
6. Press the **ENTER** button to save the adjusted value and resume normal operation.

Note: The above offset adjustment will be applied to all four inputs. At any time, the offset adjustment can be cancelled by pressing the **POWER** button.

RTD Probe Offset Adjustment

1. Set the sensor input type to "Pt".
2. Insert the RTD Pt100 Ohm probe into the PT1 or the PT2 input jack.

Note: Only one Pt100 Ohm probe can be offset at a time.

3. Press and hold the OFFSET buttons (up and down arrows) for 2 seconds to enter setup.

SEt	oFS
Pt 1	Pt 2

4. Press the ▲ or ▼ buttons to select between PT1 or PT2.

Note: "Err" will appear if the selected input does not have a probe inserted.

5. The last measurement value will be displayed on the left side of the LCD, while the offset adjusted value will be displayed on the right as shown below.

SEt	oFS
23.7	23.7

7. Press the ▲ and ▼ buttons to adjust the offset.
8. Press the **ENTER** button to save the adjusted value and resume normal operation.

Note: The above offset adjustment will be made for the selected input jack, not both. At any time, the offset adjustment can be cancelled by pressing the **POWER** button to resume to normal operation.

continued...

Data Stream Output

Using Terminal application, a data stream can be viewed from the RS-232 output, connect RS-232/USB cable between the product and terminal/PC and use the following setting to view the data stream.

Terminal Settings:

- Bits per second: 9600
- Data bits: 8
- Parity: None
- Stop bits: 1

41010100000221, = Channel T1, +22.1°C

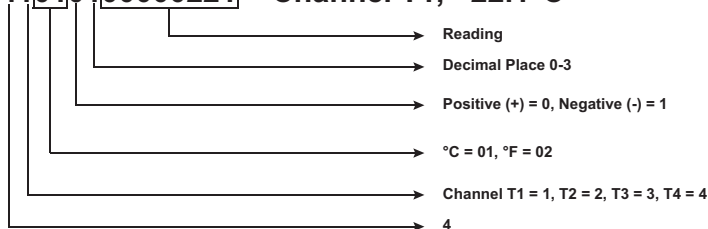

3.5mm Terminal to RS-232 Serial Connection

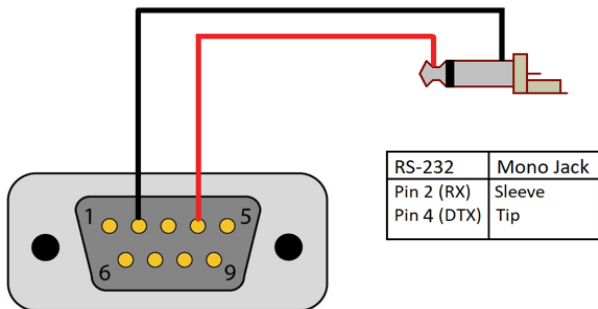

REED Instruments

1-877-849-2127 | info@reedinstruments.com | www.reedinstruments.com

Battery Replacement

When the low battery icon  appears on the LCD, the batteries must be replaced.

1. Remove the two (2) Phillips screws on the back of the meter directly located above the top of the kickstand.
2. Remove the battery cover.
3. Replace 6 x "AA" batteries.
4. Secure the battery cover with the two (2) Phillips screws.

Applications

- Medical
- Pharmaceutical
- Environmental Monitoring
- Industrial and Commercial Temperature Applications
- R&D and Educational Establishments
- Food Service

Accessories and Replacement Parts

R2920 Surface Thermocouple Probe

R2930 Right Angle Thermocouple Probe

R2940 Air/Gas Thermocouple Probe

R2950 Immersion Thermocouple Probe

R2960 Needle Tip Thermocouple Probe

TP-01 Beaded Thermocouple

R2450SD-RTD PT100 Ohm RTD Temperature Probe

R1500 Tripod

RSD-ADP-NA Power Supply, 110V

RSD-ADP-EU Power Supply, 220V

CA-05A Soft Carrying Case

R8888 Deluxe Hard Carrying Case

continued...

REED Instruments

1-877-849-2127 | info@reedinstruments.com | www.reedinstruments.com

SD-4GB 4GB Class 4 SDHC Memory Card

RSD-16GB 16GB Micro SD memory Card w/ Adapter

Don't see your part listed here? For a complete list of all accessories and replacement parts visit your product page on www.reedinstruments.com.

FAQ's

I cannot turn off my meter, do you know why?

Often times, the meter cannot be turned off because it is in recording mode ("REC" mode). Make sure to exit that function by holding down the **REC** button before attempting to turn the meter off.

Can I use multiple Thermocouple types simultaneously (i.e. Type K in channel 1 and Type J in channel 2)?

If using more than 1 channel, they must be the same thermocouple type.

How long can I record for?

Battery life will depend on a number of factors:

- Quality of Battery
- Whether the beeper is ON or OFF
- Whether the backlight is ON or OFF
- Environmental Conditions during data logging

As a reference, using alkaline batteries with both the backlight and beeper on while automatic data logging at a 2 second sampling rate; the batteries will last approximately 14 hours.

Product Care

To keep your instrument in good working order we recommend the following:

- Store your product in a clean, dry place.
- Change the battery as needed.
- If your instrument isn't being used for a period of one month or longer please remove the battery.
- Clean your product and accessories with biodegradable cleaner. Do not spray the cleaner directly on the instrument. Use on external parts only.

REED Instruments

1-877-849-2127 | info@reedinstruments.com | www.reedinstruments.com

Product Warranty

REED Instruments guarantees this instrument to be free of defects in material or workmanship for a period of one (1) year from date of shipment. During the warranty period, REED Instruments will repair or replace, at no charge, products or parts of a product that proves to be defective because of improper material or workmanship, under normal use and maintenance. REED Instruments total liability is limited to repair or replacement of the product. REED Instruments shall not be liable for damages to goods, property, or persons due to improper use or through attempts to utilize the instrument under conditions which exceed the designed capabilities. In order to begin the warranty service process, please contact us by phone at 1-877-849-2127 or by email at info@reedinstruments.com to discuss the claim and determine the appropriate steps to process the warranty.

Product Disposal and Recycling



Please follow local laws and regulations when disposing or recycling your instrument. Your product contains electronic components and must be disposed of separately from standard waste products.

Product Support

If you have any questions on your product, please contact your authorized REED distributor or REED Instruments Customer Service by phone at 1-877-849-2127 or by email at info@reedinstruments.com.

Please visit www.REEDINSTRUMENTS.com for the most up-to-date manuals, datasheets, product guides and software.

*Product specifications subject to change without notice.
All rights reserved. Any unauthorized copying or reproduction of this manual is strictly prohibited without prior written permission from REED Instruments.*

REED Instruments

1-877-849-2127 | info@reedinstruments.com | www.reedinstruments.com

REED

INSTRUMENTS

TEST & MEASURE WITH CONFIDENCE



CHECK OUT OUR LATEST PRODUCTS!

REED Instruments

1-877-849-2127 | info@reedinstruments.com | www.reedinstruments.com

REED INSTRUMENTS

TEMPERATURE
& HUMIDITY



SOUND



MOISTURE



AIR VELOCITY



ELECTRICAL



REED Instruments

1-877-849-2127 | info@reedinstruments.com | www.reedinstruments.com