

# Automotive Ferrite Chip Beads

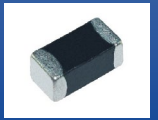

AFBC-Q0603

Request Samples



Check Inventory



1.60 x 0.8 x 0.8 mm  
RoHS/RoHS II Compliant  
MSL Level = 1

## Features

- AEC-Q200 Qualified
- Operating Temperature: -55 ~ +150°C
- Wide range impedance
- Monolithic inorganic material construction
- Excellent heat resistance
- Current ratings up to 3A

## Applications

- Electronic control Units (ECUs)
- Battery Management Systems (BMS)
- Powertrain system
- DC/AC Converters
- Industrial connectivity (IIoT)

## Electrical Specifications

Part Number	Impedance	DC Resistance	Rated Current
Units	$\Omega \pm 25\%$	$\Omega$ Max.	mA Max.
Symbol	Z	R <sub>DC</sub>	I <sub>R</sub>
AFBC-Q0603-300	30	0.04	3000
AFBC-Q0603-800	80	0.04	3000
AFBC-Q0603-121	120	0.10	2000
AFBC-Q0603-151	150	0.10	2000
AFBC-Q0603-221	220	0.10	2000
AFBC-Q0603-301	300	0.2	1000
AFBC-Q0603-471	470	0.2	1000
AFBC-Q0603-601	600	0.2	1000

### Test Conditions and Equipment

Impedance Test Frequency: 100MHz

I<sub>R</sub>: Temperature Rise: 40°C Max. At Rated Current  $\geq 1A$ .

**Operating Temperature:** -55°C to +150°C (Including self-temperature rise)

**Storage Temperature:** <+40°C and RH 60% (Max).

AFBC-Q0603 is **RoHS Compliant and Pb free**

# Automotive Ferrite Chip Beads



**AFBC-Q0603**

Request Samples



Check Inventory



**1.60 x 0.8 x 0.8 mm**  
**RoHS/RoHS II Compliant**  
**MSL Level = 1**

## Electrical Specifications (Cont'd)

**AFBC-Q0603-300**

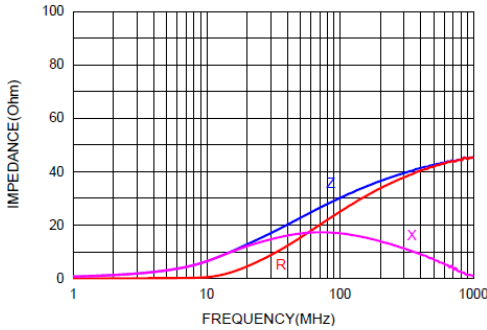

**AFBC-Q0603-800**

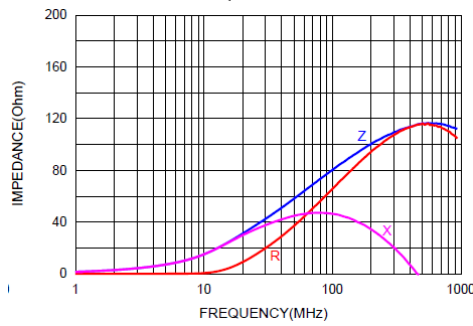

**AFBC-Q0603-121**

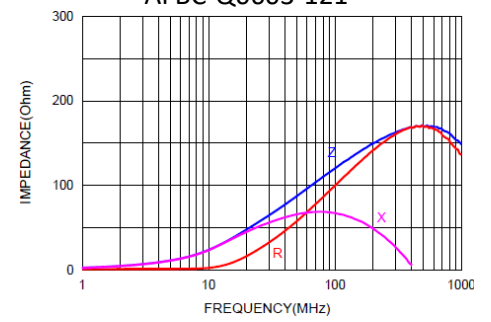

**AFBC-Q0603-151**

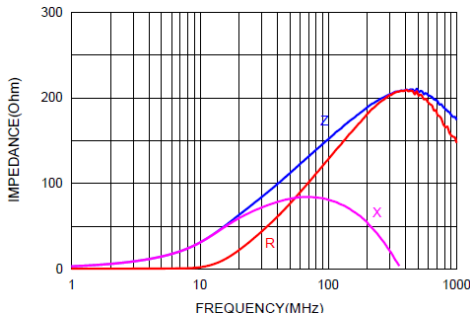

**AFBC-Q0603-221**

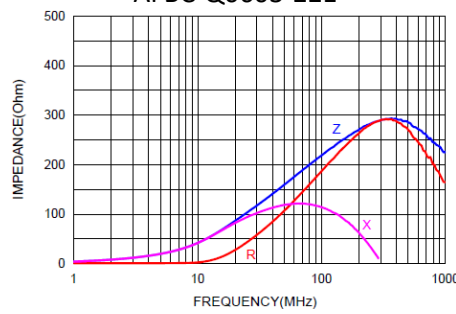

**AFBC-Q0603-301**

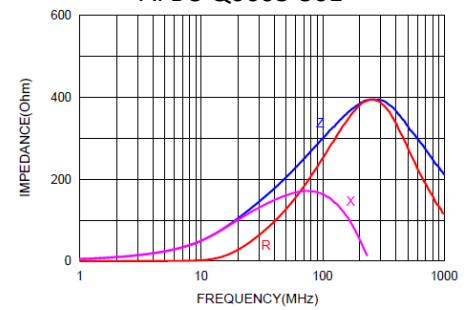

**AFBC-Q0603-471**

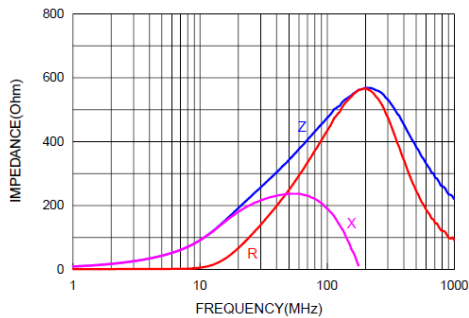

**AFBC-Q0603-601**

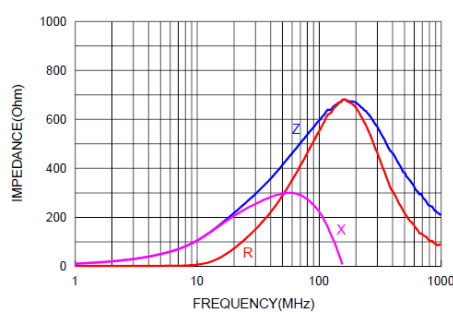

# Automotive Ferrite Chip Beads



**AFBC-Q0603**

Request Samples



Check Inventory



1.60 x 0.8 x 0.8 mm  
**RoHS/RoHS II Compliant**  
 MSL Level = 1

## Part Number Identification

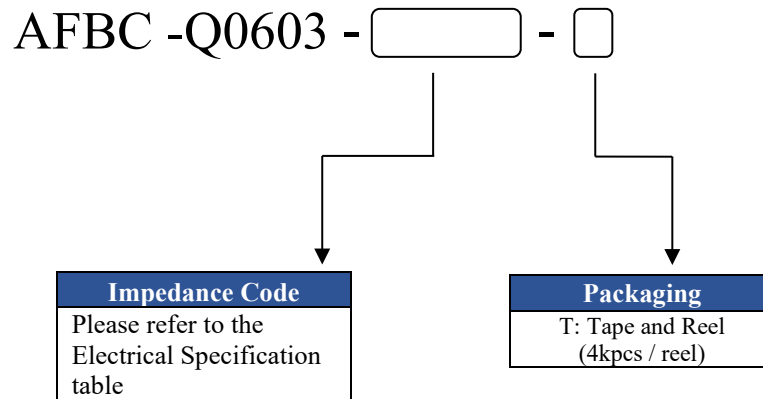

## Mechanical Specifications

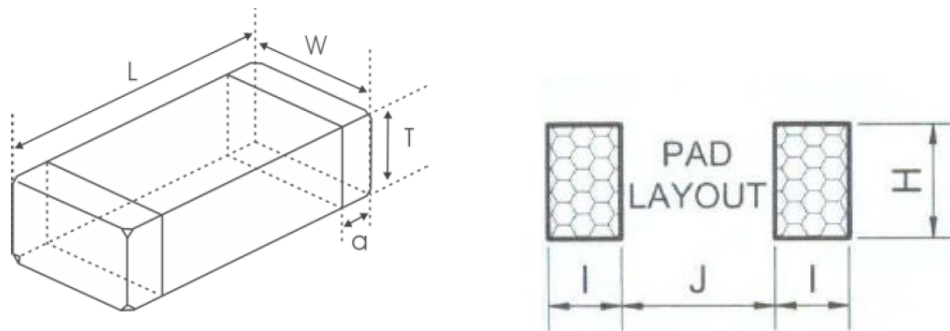

L	W	T	a	H	I	J
1.60±0.15	0.80±0.15	0.80±0.15	0.30±0.20	0.95 Ref.	0.80 Ref.	0.85 Ref.

**Dimension: mm**

# Automotive Ferrite Chip Beads



**AFBC-Q0603**

Request Samples



Check Inventory



1.60 x 0.8 x 0.8 mm  
**RoHS/RoHS II Compliant**  
 MSL Level = 1

## Materials

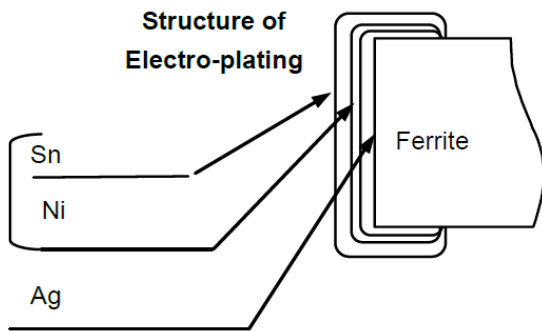

Structure Description	
1	Ferrite for Beads
2	Internal Terminal Electrode: Ag (100%)
3	Electro-plating: Ni (100%)
4	External Electro-plating: Sn (100%)

## Reflow Profile

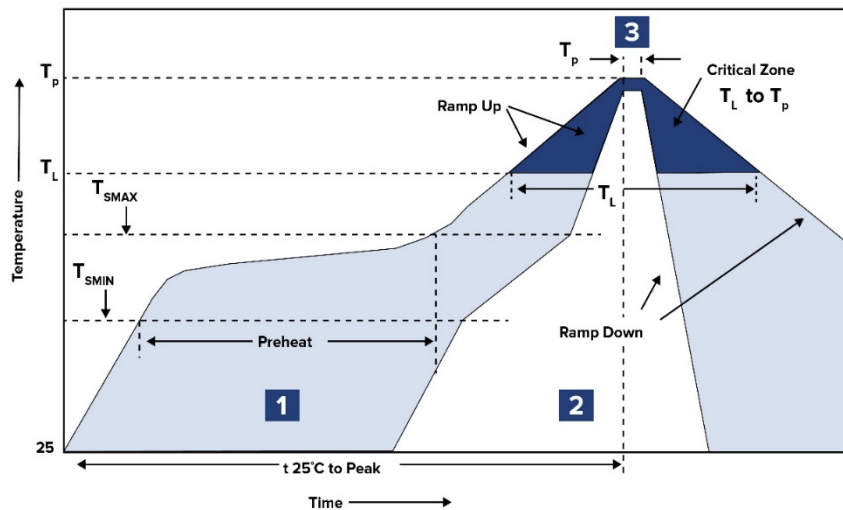

Zone	Description	Temperature	Times
1	Preheat	$T_{SMIN} \sim T_{SMAX}$ 150°C ~ 200°C	60 ~ 180 sec.
2	Reflow	$T_L$ 245°C	20 ~ 40 sec.
3	Peak heat	$T_P$ 260°C	10 sec. MAX

# Automotive Ferrite Chip Beads

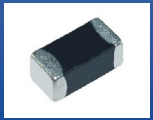

**AFBC-Q0603**

Request Samples



Check Inventory



**1.60 x 0.8 x 0.8 mm**  
**RoHS/RoHS II Compliant**  
**MSL Level = 1**

## Packaging

**T= Tape and reel (4,000 pcs/reel)**

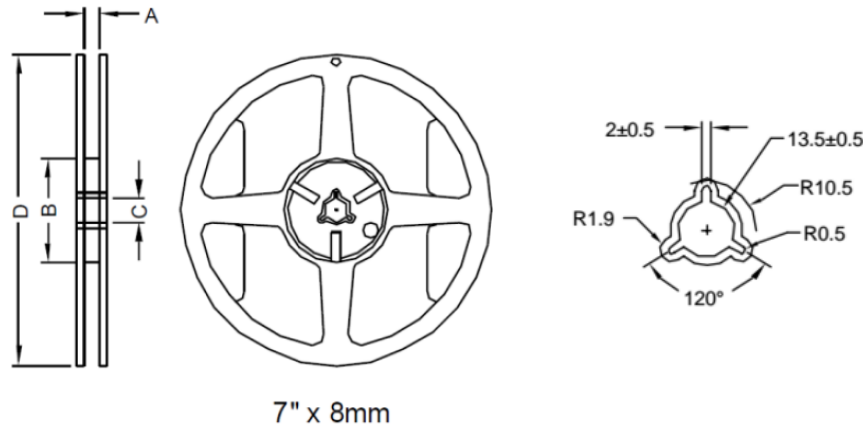

Type	A	B	C	D
7"x8mm	9.0 ± 0.5	60.0 ± 2.0	13.5 ± 0.5	178.0 ± 2.0

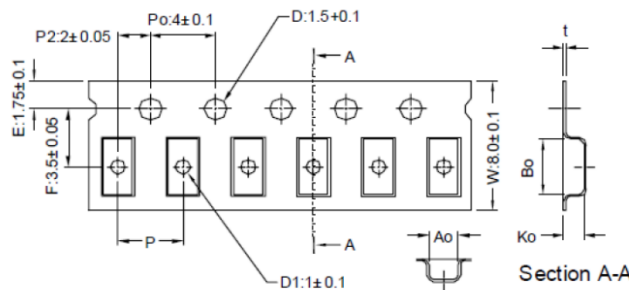

Series	Bo	Ao	Ko	P
AFBC-Q0603	1.80 ± 0.05	0.96 ± 0.05	0.95 ± 0.05	4.00 ± 0.10

**Dimension: mm**

**ATTENTION:** Abracon LLC's products are COTS – Commercial-Off-The-Shelf products; suitable for Commercial, Industrial and, where designated, Automotive Applications. Abracon's products are not specifically designed for Military, Aviation, Aerospace, Life-dependent Medical applications or any application requiring high reliability where component failure could result in loss of life and/or property. For applications requiring high reliability and/or presenting an extreme operating environment, written consent and authorization from Abracon LLC is required. Please contact Abracon LLC for more information.



5101 Hidden Creek Ln Spicewood TX 78669  
 Phone: 512-371-6159 | Fax: 512-351-8858  
 For terms and conditions of sales, please visit:  
[www.abracon.com](http://www.abracon.com)

**REVISION: IR 08-10-22**

ABRACON IS  
 ISO9001-2015  
 CERTIFIED