

DO NOT SCALE FROM THIS PRINT

NOTES:

1. SET UP ASP PART NUMBER FOR INDUSTRY STANDARD.
2. Ⓢ REPRESENTS A CRITICAL DIMENSION.
3. MAXIMUM BURR ALLOWANCE: 0.015[0.038]
4. MINIMUM PUSHOUT FORCE: .5 LB
5. PARTS TO BE PACKAGED IN TAPE AND REEL.
6. FOR QUANTITIES UP TO 49 PEICES, NO LEADER, TRAILOR, OR EIA-481-D REEL WILL BE SUPPLIED. FOR QUANTITIES OF 50-124 PIECES, NO LEADER OR TRAILOR WILL BE SUPPLIED.

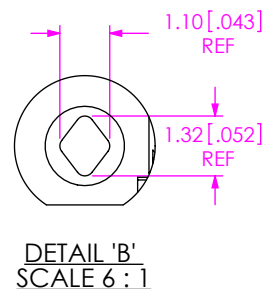
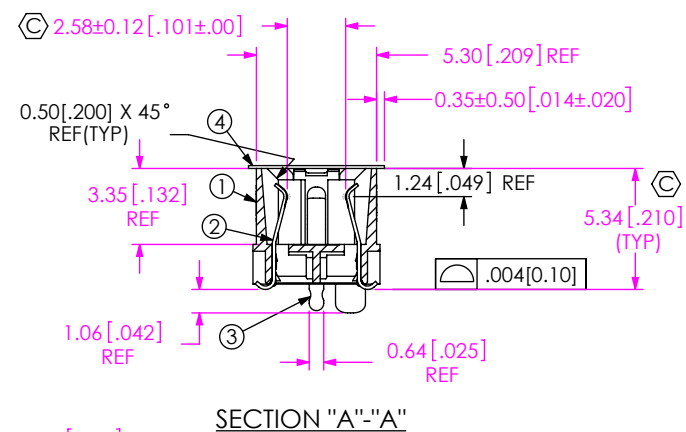
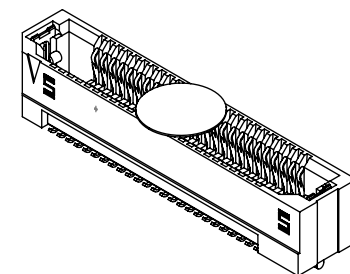
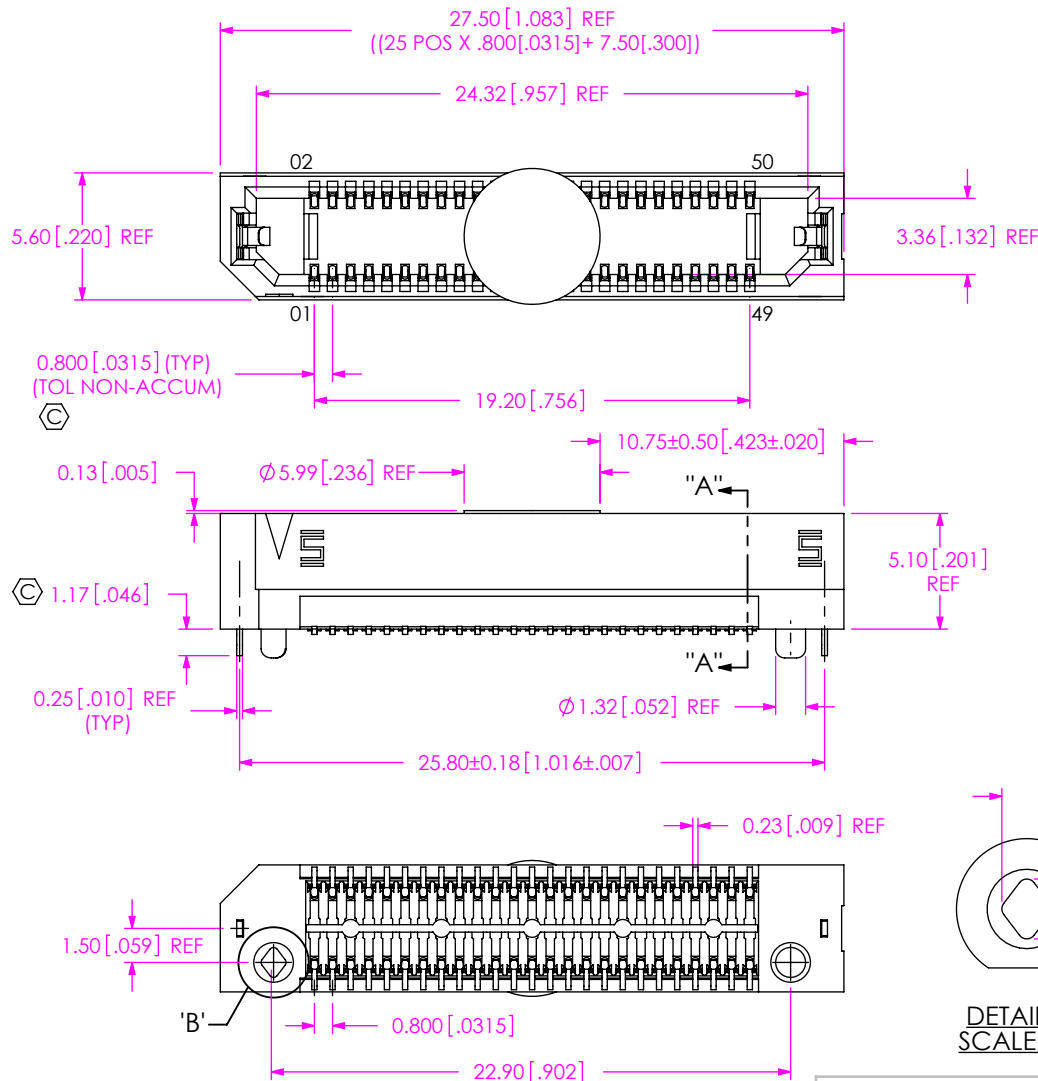

UNLESS OTHERWISE SPECIFIED, DIMENSIONS ARE IN MILLIMETERS TOLERANCES ARE:
 DECIMALS ANGLES
 .XX: ±0.3[01] 2°
 .XXX: ±0.13[005]
 .XXXX: ±0.051[0020]

PROPRIETARY NOTE
 THIS DOCUMENT CONTAINS CONFIDENTIAL AND PROPRIETARY INFORMATION AND ALL DESIGN, MANUFACTURING, REPRODUCTION, USE, PATENT RIGHTS AND SALES RIGHTS ARE EXPRESSLY RESERVED BY SAMTEC, INC. THIS DOCUMENT SHALL NOT BE DISCLOSED, IN WHOLE OR PART, TO ANY UNAUTHORIZED PERSON OR ENTITY NOR REPRODUCED, TRANSFERRED OR INCORPORATED IN ANY OTHER PROJECT IN ANY MANNER WITHOUT THE EXPRESS WRITTEN CONSENT OF SAMTEC, INC.



520 PARK EAST BLVD, NEW ALBANY, IN 47150
 PHONE: 812-944-6733 FAX: 812-948-5047
 e-Mail: info@SAMTEC.com code 55322

DO NOT SCALE DRAWING SHEET SCALE: 3:1
 PLATING:
 CONTACTS:
 CONTACT AREA: .00030" GOLD OVER .000050" NICKEL
 REMAINDER: .000200" REF TIN OVER .000050" NICKEL
 WELD TAB: .000003" GOLD OVER .000050" NICKEL

DESCRIPTION:
 .8MM EDGE RATE SOCKET ASM

DWG. NO.
 ASP-148422-01

BY: TAMMY W. 06/12/09 SHEET 1 OF 2

ITEM NO.	PART NUMBER	QUANTITY	MATERIAL
1	ERF8-025-05.0-DV-L	1.0000	VECTRA E130i, COLOR: BLACK
2	C-211-05.0-S	50.000	BeCu, ALLOY 390 HT
3	WT-30-01-F	2.0000	BeCu, #25, 1/2 HT
4	K-DOT-.236-.343-.005	1.0000	POLYIMIDE FILM
5	CT-ERF8016MS	1.0000	CONDUCTIVE POLYMER

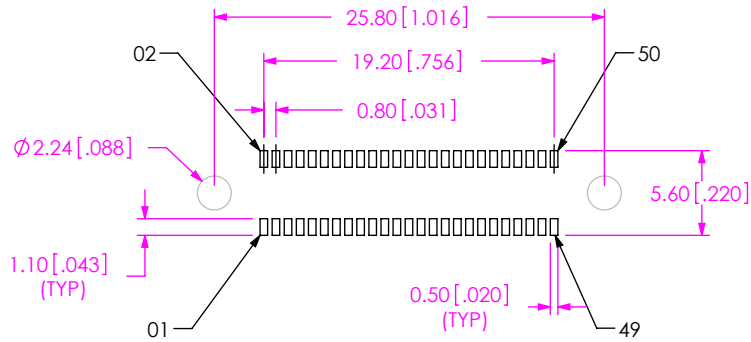

RECOMMENDED STENCIL LAYOUT

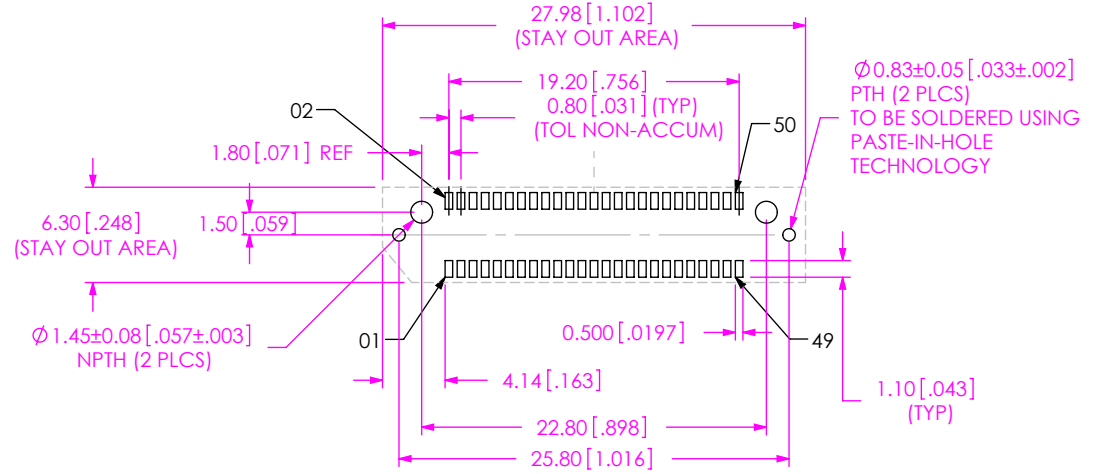

RECOMMENDED PCB LAYOUT

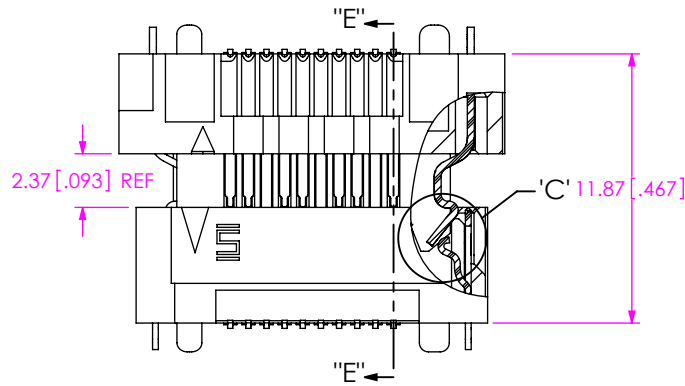

LATCH ENGAGING VIEW

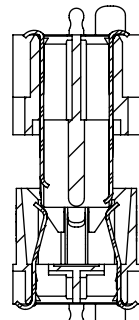

SECTION "E"-"E"
SCALE 3 : 1

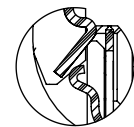

DETAIL 'C'

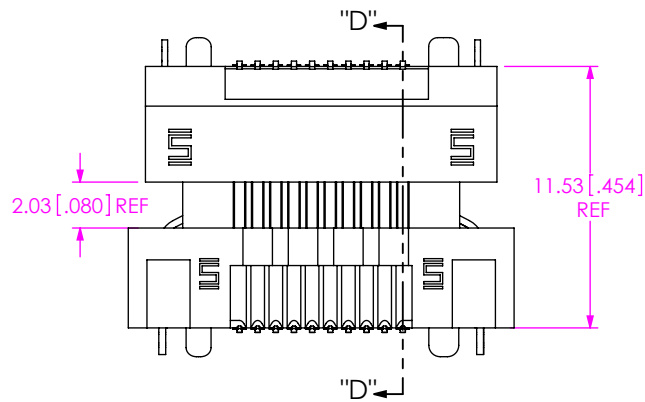

PIN ENGAGING VIEW

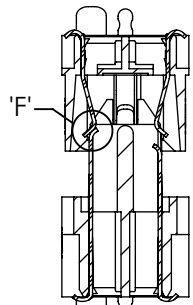

SECTION "D"-"D"
SCALE 3 : 1

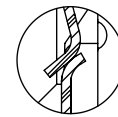

DETAIL 'F'
SCALE 8 : 1

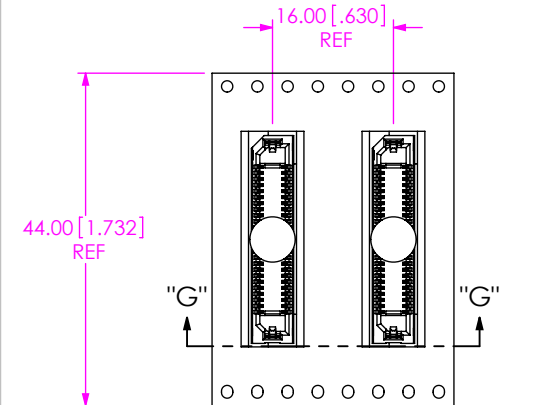

USER DIRECTION OF UN-REELING
POCKET NOT DETAILED

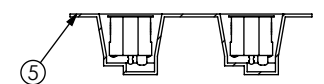

SECTION "G"-"G"
SCALE 1 : 1

PACKAGING VIEW

PROPRIETARY NOTE
THIS DOCUMENT CONTAINS CONFIDENTIAL AND PROPRIETARY INFORMATION AND ALL DESIGN, MANUFACTURING, REPRODUCTION, USE, PATENT RIGHTS AND SALES RIGHTS ARE EXPRESSLY RESERVED BY SAMTEC, INC. THIS DOCUMENT SHALL NOT BE DISCLOSED, IN WHOLE OR PART, TO ANY UNAUTHORIZED PERSON OR ENTITY NOR REPRODUCED, TRANSFERRED OR INCORPORATED IN ANY OTHER PROJECT IN ANY MANNER WITHOUT THE EXPRESS WRITTEN CONSENT OF SAMTEC, INC.

SHEET SCALE: 4:1

samtec

520 PARK EAST BLVD, NEW ALBANY, IN 47150
PHONE: 812-944-6733 FAX: 812-948-5047
e-Mail info@SAMTEC.com code 53322

DESCRIPTION:
.8MM EDGE RATE SOCKET ASM

DWG. NO.
ASP-148422-01

BY: TAMMY W. 06/12/09 SHEET 2 OF 2