

RECOMMENDED PCB(CONNECTOR SIDE VIEW)
THICKNESS=1.6 TO 2.4 MM

FUNCTIONAL SYMBOLS	THIS DRAWING CONTAINS INFORMATION THAT IS PROPRIETARY TO MOLEX ELECTRONIC TECHNOLOGIES, LLC AND SHOULD NOT BE USED WITHOUT WRITTEN PERMISSION		CURRENT REV DESC:		molex	
	GENERAL TOLERANCES (UNLESS SPECIFIED)	ANGULAR TOL $\pm 3.0^\circ$	EC NO: 697101	2022/02/24		HEADER OF NANO-FIT, D/R, CLIP, VERTICAL POWER CONNECTOR
DIVISIONAL SYMBOLS	4 PLACES \pm	3 PLACES ± 0.1	DRWN: GLLI	2022/02/25	PRODUCT CUSTOMER DRAWING	
	2 PLACES ± 0.2	1 PLACE ± 0.3	CHK'D: XQZHANG	2022/02/25		DOCUMENT NUMBER
	0 PLACES \pm	DRAFT WHERE APPLICABLE MUST REMAIN WITHIN DIMENSIONS	APPR: XQZHANG	2022/02/25	1053121000-SD	DOC TYPE
	THIRD ANGLE PROJECTION	DRAWING	SERIES	MATERIAL NUMBER	CUSTOMER	DOC PART
			A3-SIZE	105312	GENERAL MARKET	REVISION
						B1
						1 OF 5

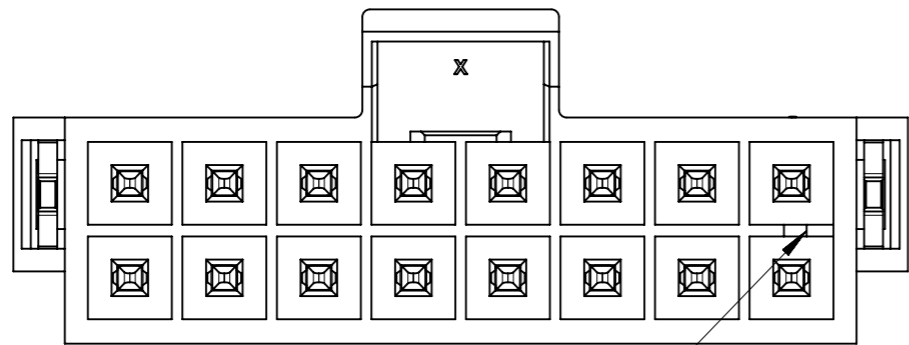

KEY A



KEY A

BLACK

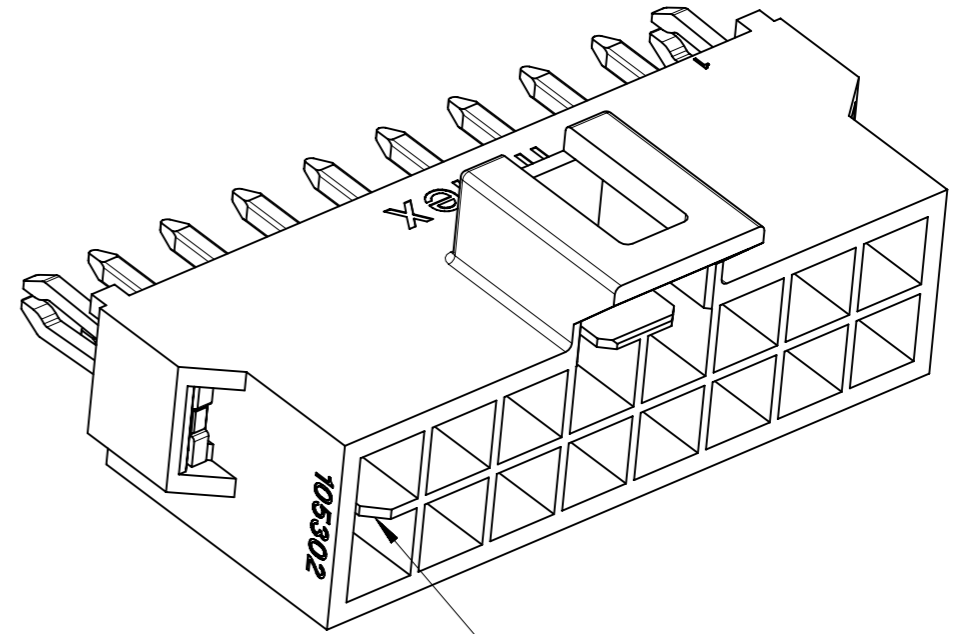

KEY B

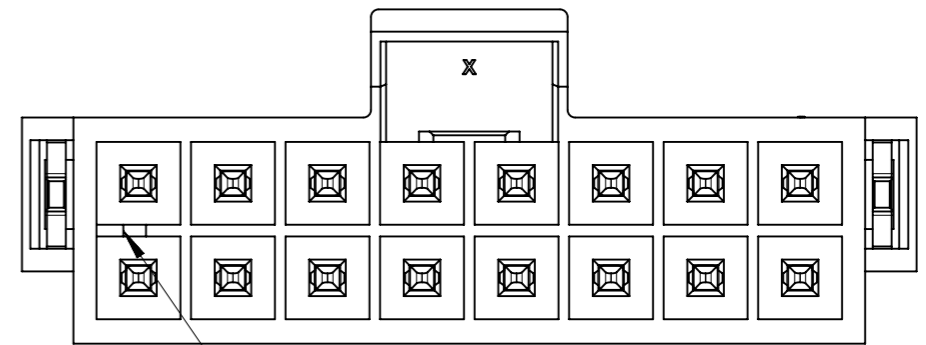

KEY B

NATURAL

COLOR OPTION

FUNCTIONAL SYMBOLS	THIS DRAWING CONTAINS INFORMATION THAT IS PROPRIETARY TO MOLEX ELECTRONIC TECHNOLOGIES, LLC AND SHOULD NOT BE USED WITHOUT WRITTEN PERMISSION		CURRENT REV DESC:		molex			
	▽A = 0	mm						SCALE 5:1
▽E = 0	GENERAL TOLERANCES (UNLESS SPECIFIED)		EC NO: 697101 DRWN: GLLI 2022/02/24 CHK'D: XQZHANG 2022/02/25 APPR: XQZHANG 2022/02/25 INITIAL REVISION: DRWN: GLLI 2019/09/24 APPR: YXZHENG 2020/03/16		HEADER OF NANO-FIT, D/R, CLIP, VERTICAL POWER CONNECTOR			
▽E = 0	ANGULAR TOL ± 3.0°				PRODUCT CUSTOMER DRAWING			
DIVISIONAL SYMBOLS	4 PLACES ±	0.1			DOCUMENT NUMBER	DOC TYPE	DOC PART	REVISION
	3 PLACES ±	0.2			1053121000-SD	PSD	000	B1
	2 PLACES ±	0.3			MATERIAL NUMBER	CUSTOMER		SHEET NUMBER
	1 PLACE ±	0.3	A3-SIZE	GENERAL MARKET		2 OF 5		
	0 PLACES ±		THIRD ANGLE PROJECTION					
	DRAFT WHERE APPLICABLE MUST REMAIN WITHIN DIMENSIONS							

DOCUMENT STATUS	P1	RELEASE DATE	2022/02/25	03:08:44
-----------------	----	--------------	------------	----------

PART NUMBER	DIM 'A'	DIM 'B'	DIM 'C'	CKT SIZE	PLATING	MYLAR
105312-3504	8.66	5.94	6.84	4	TIN	YES
105312-3506	11.16	8.44	9.34	6		
105312-3508	13.66	10.94	11.84	8		
105312-3510	16.16	13.44	14.34	10		
105312-3512	18.66	15.94	16.84	12		
105312-3514	21.16	18.44	19.34	14		
105312-3516	23.66	20.94	21.84	16		
105312-3704	8.66	5.94	6.84	4	GOLD 0.38	
105312-3706	11.16	8.44	9.34	6		
105312-3708	13.66	10.94	11.84	8		
105312-3710	16.16	13.44	14.34	10		
105312-3712	18.66	15.94	16.84	12		
105312-3714	21.16	18.44	19.34	14		
105312-3716	23.66	20.94	21.84	16		
105312-3604	8.66	5.94	6.84	4	GOLD 0.76	
105312-3606	11.16	8.44	9.34	6		
105312-3608	13.66	10.94	11.84	8		
105312-3610	16.16	13.44	14.34	10		
105312-3612	18.66	15.94	16.84	12		
105312-3614	21.16	18.44	19.34	14		
105312-3616	23.66	20.94	21.84	16		
105312-3804	8.66	5.94	6.84	4	GOLD 0.76 + LUBE	
105312-3806	11.16	8.44	9.34	6		
105312-3808	13.66	10.94	11.84	8		
105312-3810	16.16	13.44	14.34	10		
105312-3812	18.66	15.94	16.84	12		
105312-3814	21.16	18.44	19.34	14		
105312-3816	23.66	20.94	21.84	16		

COLOR: BLACK

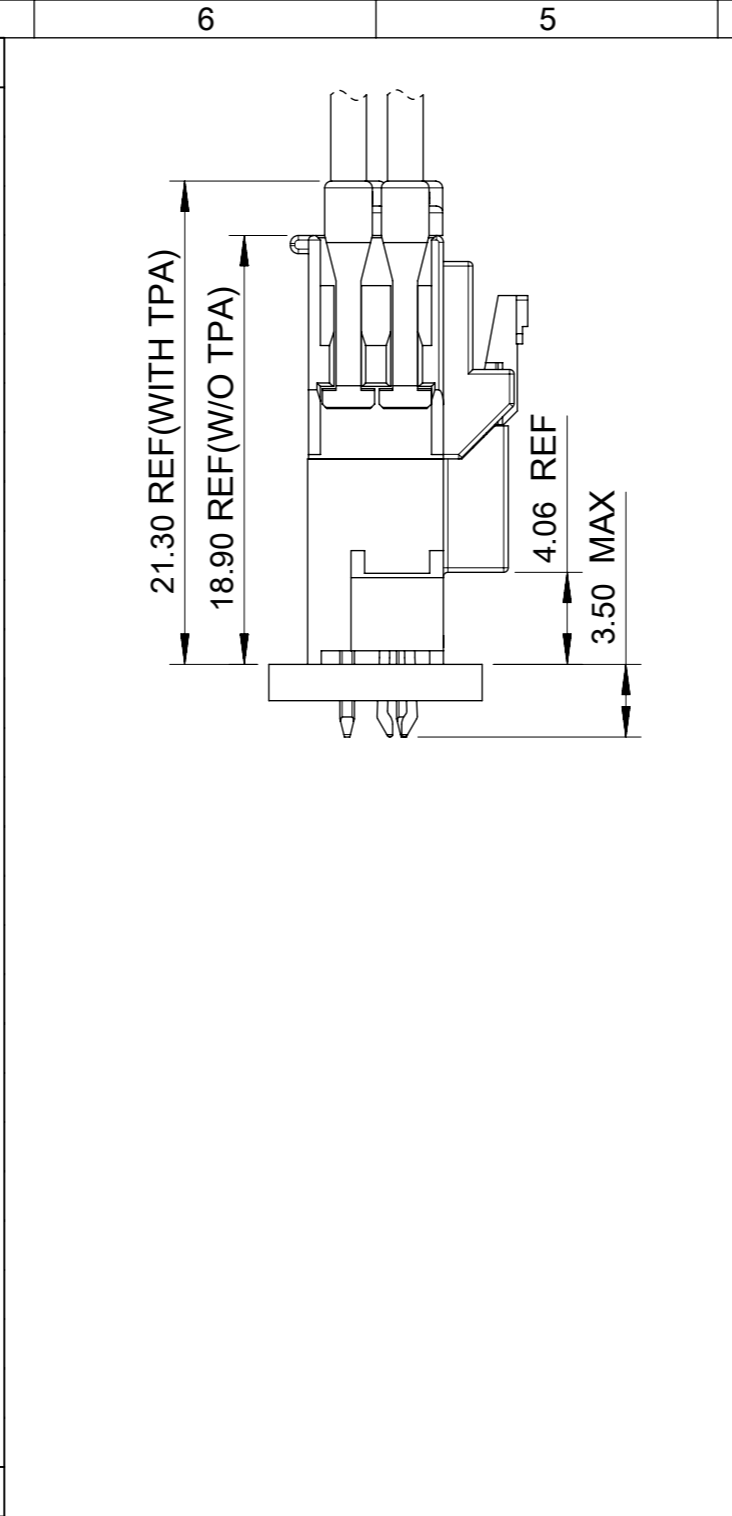

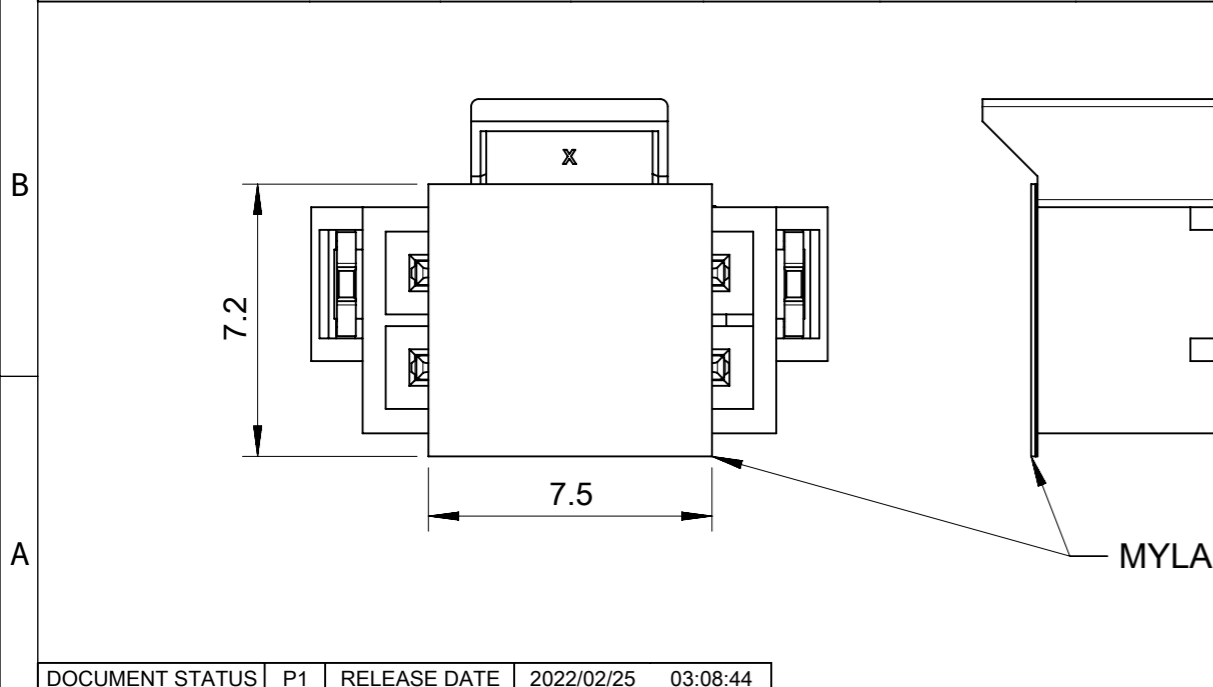

PART NUMBER	DIM 'A'	DIM 'B'	DIM 'C'	CKT SIZE	PLATING	MYLAR
105312-4504	8.66	5.94	6.84	4	TIN	YES
105312-4506	11.16	8.44	9.34	6		
105312-4508	13.66	10.94	11.84	8		
105312-4510	16.16	13.44	14.34	10		
105312-4512	18.66	15.94	16.84	12		
105312-4514	21.16	18.44	19.34	14		
105312-4516	23.66	20.94	21.84	16		
105312-4704	8.66	5.94	6.84	4	GOLD 0.38	
105312-4706	11.16	8.44	9.34	6		
105312-4708	13.66	10.94	11.84	8		
105312-4710	16.16	13.44	14.34	10		
105312-4712	18.66	15.94	16.84	12		
105312-4714	21.16	18.44	19.34	14		
105312-4716	23.66	20.94	21.84	16		
105312-4604	8.66	5.94	6.84	4	GOLD 0.76	
105312-4606	11.16	8.44	9.34	6		
105312-4608	13.66	10.94	11.84	8		
105312-4610	16.16	13.44	14.34	10		
105312-4612	18.66	15.94	16.84	12		
105312-4614	21.16	18.44	19.34	14		
105312-4616	23.66	20.94	21.84	16		
105312-4804	8.66	5.94	6.84	4	GOLD 0.76 + LUBE	
105312-4806	11.16	8.44	9.34	6		
105312-4808	13.66	10.94	11.84	8		
105312-4810	16.16	13.44	14.34	10		
105312-4812	18.66	15.94	16.84	12		
105312-4814	21.16	18.44	19.34	14		
105312-4816	23.66	20.94	21.84	16		

COLOR: NATURAL



FUNCTIONAL SYMBOLS	THIS DRAWING CONTAINS INFORMATION THAT IS PROPRIETARY TO MOLEX ELECTRONIC TECHNOLOGIES, LLC AND SHOULD NOT BE USED WITHOUT WRITTEN PERMISSION	CURRENT REV DESC:		molex																																														
	<table border="1"> <tr><td>FUNCTIONAL SYMBOLS</td><td>DIMENSION UNITS</td><td>SCALE</td></tr> <tr><td>$\nabla_A = 0$</td><td>mm</td><td>5:1</td></tr> <tr><td>$\nabla_E = 0$</td><td colspan="2">GENERAL TOLERANCES (UNLESS SPECIFIED)</td></tr> <tr><td>$\nabla_F = 0$</td><td colspan="2">ANGULAR TOL $\pm 3.0^\circ$</td></tr> <tr><td rowspan="5">DIVISIONAL SYMBOLS</td><td>4 PLACES</td><td>\pm</td></tr> <tr><td>3 PLACES</td><td>± 0.1</td></tr> <tr><td>2 PLACES</td><td>± 0.2</td></tr> <tr><td>1 PLACE</td><td>± 0.3</td></tr> <tr><td>0 PLACES</td><td>\pm</td></tr> </table>	FUNCTIONAL SYMBOLS	DIMENSION UNITS		SCALE	$\nabla_A = 0$	mm	5:1	$\nabla_E = 0$	GENERAL TOLERANCES (UNLESS SPECIFIED)		$\nabla_F = 0$	ANGULAR TOL $\pm 3.0^\circ$		DIVISIONAL SYMBOLS	4 PLACES	\pm	3 PLACES	± 0.1	2 PLACES	± 0.2	1 PLACE	± 0.3	0 PLACES	\pm	<table border="1"> <tr><td>EC NO: 697101</td><td>2022/02/24</td></tr> <tr><td>DRWN: GLLI</td><td>2022/02/25</td></tr> <tr><td>CHK'D: XQZHANG</td><td>2022/02/25</td></tr> <tr><td>APPR: XQZHANG</td><td>2022/02/25</td></tr> </table>		EC NO: 697101	2022/02/24	DRWN: GLLI	2022/02/25	CHK'D: XQZHANG	2022/02/25	APPR: XQZHANG	2022/02/25	<table border="1"> <tr><td colspan="4">HEADER OF NANO-FIT, D/R, CLIP, VERTICAL POWER CONNECTOR</td></tr> <tr><td colspan="4">PRODUCT CUSTOMER DRAWING</td></tr> <tr><td>DOCUMENT NUMBER</td><td>DOC TYPE</td><td>DOC PART</td><td>REVISION</td></tr> <tr><td>1053121000-SD</td><td>PSD</td><td>000</td><td>B1</td></tr> </table>	HEADER OF NANO-FIT, D/R, CLIP, VERTICAL POWER CONNECTOR				PRODUCT CUSTOMER DRAWING				DOCUMENT NUMBER	DOC TYPE	DOC PART	REVISION	1053121000-SD	PSD
FUNCTIONAL SYMBOLS	DIMENSION UNITS	SCALE																																																
$\nabla_A = 0$	mm	5:1																																																
$\nabla_E = 0$	GENERAL TOLERANCES (UNLESS SPECIFIED)																																																	
$\nabla_F = 0$	ANGULAR TOL $\pm 3.0^\circ$																																																	
DIVISIONAL SYMBOLS	4 PLACES	\pm																																																
	3 PLACES	± 0.1																																																
	2 PLACES	± 0.2																																																
	1 PLACE	± 0.3																																																
	0 PLACES	\pm																																																
EC NO: 697101	2022/02/24																																																	
DRWN: GLLI	2022/02/25																																																	
CHK'D: XQZHANG	2022/02/25																																																	
APPR: XQZHANG	2022/02/25																																																	
HEADER OF NANO-FIT, D/R, CLIP, VERTICAL POWER CONNECTOR																																																		
PRODUCT CUSTOMER DRAWING																																																		
DOCUMENT NUMBER	DOC TYPE	DOC PART	REVISION																																															
1053121000-SD	PSD	000	B1																																															
<table border="1"> <tr><td>DRAFT WHERE APPLICABLE MUST REMAIN WITHIN DIMENSIONS</td><td>THIRD ANGLE PROJECTION</td><td>DRAWING</td><td>SERIES</td><td>MATERIAL NUMBER</td><td>CUSTOMER</td><td>SHEET NUMBER</td></tr> <tr><td></td><td></td><td>A3-SIZE</td><td>105312</td><td></td><td>GENERAL MARKET</td><td>3 OF 5</td></tr> </table>		DRAFT WHERE APPLICABLE MUST REMAIN WITHIN DIMENSIONS	THIRD ANGLE PROJECTION	DRAWING	SERIES	MATERIAL NUMBER	CUSTOMER	SHEET NUMBER			A3-SIZE	105312		GENERAL MARKET	3 OF 5	<table border="1"> <tr><td>EC NO: 697101</td><td>2022/02/24</td></tr> <tr><td>DRWN: GLLI</td><td>2022/02/25</td></tr> <tr><td>CHK'D: XQZHANG</td><td>2022/02/25</td></tr> <tr><td>APPR: XQZHANG</td><td>2022/02/25</td></tr> </table>		EC NO: 697101	2022/02/24	DRWN: GLLI	2022/02/25	CHK'D: XQZHANG	2022/02/25	APPR: XQZHANG	2022/02/25	<table border="1"> <tr><td>INITIAL REVISION:</td><td>2019/09/24</td></tr> <tr><td>DRWN: GLLI</td><td>2020/03/16</td></tr> <tr><td>APPR: YXZHENG</td><td></td></tr> </table>	INITIAL REVISION:	2019/09/24	DRWN: GLLI	2020/03/16	APPR: YXZHENG																			
DRAFT WHERE APPLICABLE MUST REMAIN WITHIN DIMENSIONS	THIRD ANGLE PROJECTION	DRAWING	SERIES	MATERIAL NUMBER	CUSTOMER	SHEET NUMBER																																												
		A3-SIZE	105312		GENERAL MARKET	3 OF 5																																												
EC NO: 697101	2022/02/24																																																	
DRWN: GLLI	2022/02/25																																																	
CHK'D: XQZHANG	2022/02/25																																																	
APPR: XQZHANG	2022/02/25																																																	
INITIAL REVISION:	2019/09/24																																																	
DRWN: GLLI	2020/03/16																																																	
APPR: YXZHENG																																																		

		4 CKT	6 CKT	8 CKT	10 CKT
F	BLACK				
E	NATURAL				
		12 CKT	14 CKT	16 CKT	
D	BLACK				
C	NATURAL				

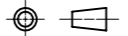
FUNCTIONAL SYMBOLS  = 0  = 0  = 0 DIVISIONAL SYMBOLS	THIS DRAWING CONTAINS INFORMATION THAT IS PROPRIETARY TO MOLEX ELECTRONIC TECHNOLOGIES, LLC AND SHOULD NOT BE USED WITHOUT WRITTEN PERMISSION DIMENSION UNITS: mm SCALE: 3:1 GENERAL TOLERANCES (UNLESS SPECIFIED) ANGULAR TOL ± 3.0° 4 PLACES ± 3 PLACES ± 0.1 2 PLACES ± 0.2 1 PLACE ± 0.3 0 PLACES ± DRAFT WHERE APPLICABLE MUST REMAIN WITHIN DIMENSIONS	CURRENT REV DESC: EC NO: 697101 DRWN: GLLI APPR: XQZHANG INITIAL REVISION: DRWN: GLLI APPR: YXZHENG	 HEADER OF NANO-FIT, D/R, CLIP, VERTICAL POWER CONNECTOR PRODUCT CUSTOMER DRAWING	
	2022/02/24 2022/02/25 2022/02/25	2019/09/24 2020/03/16	DOCUMENT NUMBER: 1053121000-SD DOC TYPE: PSD DOC PART: 000 REVISION: B1	
	THIRD ANGLE PROJECTION 	DRAWING: A3-SIZE SERIES: 105312	MATERIAL NUMBER: 1053121000-SD CUSTOMER: GENERAL MARKET	SHEET NUMBER: 4 OF 5

NOTES FOR ALL PARTS

1> MATERIAL:
 HOUSING: LCP, UL 94V-0.
 TERMINAL: BRASS.
 SOLDER CLIP: BRASS.

2> PLATING FINISHED:
 TERMINAL:
 CONTACT AREA: a. REFLOW MATTE TIN 1.5MICRONS MIN;
 b. GOLD 0.38 MICRONS MIN;
 c. GOLD 0.76 MICRONS MIN.
 SOLDER AREA: MATTE TIN 1.5 MICRONS MIN, UNDER PLATING NICKEL 1.25 MICRONS MIN.
 SOLDER CLIP: MATTE TIN 2.5 MICRONS MIN, UNDER PLATING NICKEL 1.25 MICRONS MIN.

3> PRODUCT SPECIFICATION: PS-105300-100.
 4> PACKAGE: TAPE REEL, 1053121000-PK.
 5> PRODUCT MATE WITH SERIES OF 105308(RECEPTACLE), 105300(CRIMP TERMINAL).
 6> PARTS CONFORM TO CLASS 'B'REQUIREMENTS OF COSMETIC SPECIFICATION PS-45499-002.
 7> DISCOLORATION IN THE BANDOLIER PIN CARRIER AREA OF THE PIN IS INHERENT TO THE PLATING PROCESS AND IS DUE TO THE MASKING DEFECT OF THE CARRIER, THIS DISCOLORATION IS IN A NON-FUNCTION AREA OF THE PIN AND WILL NOT AFFECT THE PERFORMANCE OF THE HEADER ASSEMBLY.

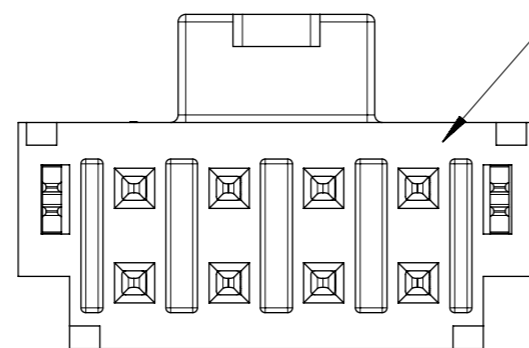

IF ANY NUMBER MARK APPEARS ON THIS SURFACE, PLEASE DISREGARD IT, IT IS NO ANY FUCTION AND NO ANY RELATION TO PIN NUMBER, IT IS JUST FOR MOLDING IDENDIFICATION.

FUNCTIONAL SYMBOLS	THIS DRAWING CONTAINS INFORMATION THAT IS PROPRIETARY TO MOLEX ELECTRONIC TECHNOLOGIES, LLC AND SHOULD NOT BE USED WITHOUT WRITTEN PERMISSION		CURRENT REV DESC:		molex					
	DIMENSION UNITS	SCALE								
$\nabla_A = 0$	mm	1:1	EC NO: 697101 DRWN: GLLI CHK'D: XQZHANG APPR: XQZHANG		HEADER OF NANO-FIT, D/R, CLIP, VERTICAL POWER CONNECTOR					
$\nabla_B = 0$	GENERAL TOLERANCES (UNLESS SPECIFIED)									
$\nabla_C = 0$	ANGULAR TOL $\pm 3.0^\circ$									
DIVISIONAL SYMBOLS	4 PLACES	\pm	INITIAL REVISION: DRWN: GLLI APPR: YXZHENG		DOCUMENT NUMBER		DOC TYPE	DOC PART	REVISION	
	3 PLACES	± 0.1			1053121000-SD		PSD	000	B1	
	2 PLACES	± 0.2			2019/09/24 2020/03/16					
	1 PLACE	± 0.3								
0 PLACES	\pm			MATERIAL NUMBER		CUSTOMER		SHEET NUMBER		
DRAFT WHERE APPLICABLE MUST REMAIN WITHIN DIMENSIONS		THIRD ANGLE PROJECTION		DRAWING	SERIES	GENERAL MARKET		5 OF 5		
				A3-SIZE	105312					