

Vacuum generators VADM/VADMI

FESTO



Key features

Product overview

All Festo vacuum generators have a single-stage design and operate according to the Venturi principle.

The product series described below have been designed for a wide range of applications. The different performance classes of the individual product series make it possible to select vacuum generators tailored to suit the specific requirements of each application.

Standard and inline ejectors

VN

Datasheets → Internet: vn



- Nominal width
0.45 ... 3 mm
- Max. vacuum
93%
- Temperature range
0 ... +60°C
- A range of extremely effective generators suitable for use directly in the work space
- Available as a straight or T-shaped design
- Small footprint
- Cost effective
- No wearing parts
- Extremely fast evacuation time
- Optional vacuum switch
- Optional additional functions:
 - Integrated ejector pulse
 - Electrical control for vacuum ON/OFF
 - Combination of ejector pulse and actuation

VAD/VAK

Datasheets → Internet: vad



- Nominal width
0.5 ... 1.5 mm
- Max. vacuum
80%
- Temperature range
–20 ... +80°C
- Range of vacuum generators with sturdy aluminium housing
- VAK-...: integrated volume,
VAD-...: connection for external volume
- Maintenance-free
- VAK: reliable setting down of workpieces

Key features

Compact ejectors

OVEM

Datasheets → Internet: [ovem](#)

- Nominal width
0.45 ... 2 mm
- Max. vacuum
93%
- Temperature range
0 ... +50°C
- Compact design
- Minimal installation effort
- Short switching times
- Integrated solenoid valves for vacuum ON/OFF and ejector pulse
- Filter with display
- Vacuum sensor with LCD display for continuous monitoring of the entire vacuum system
- Optional air saving function
- Reliable setting down of workpieces
- Interlocking of multiple vacuum generators on a common supply manifold

VADM/VADMI

→ page 7



- Nominal width
0.45 ... 3 mm
- Max. vacuum
85%
- Temperature range
0 ... +60°C
- Compact design
- Minimal installation effort
- Short switching times
- Built-in solenoid valve (on/off)
- VADMI: additional integrated solenoid valve for ejector pulse
- Filter with display
- Optional air saving function
- Optional vacuum switch
- Reliable setting down of workpieces

VAD-M

Datasheets → Internet: [vad-m](#)

- Nominal width
0.7 ... 2 mm
- Max. vacuum
85%
- Temperature range
0 ... +40°C
- Compact design
- Minimal installation effort
- Short switching times
- Built-in solenoid valve (on/off)
- VAD-M-I: additional integrated solenoid valve for ejector pulse
- Reliable setting down of workpieces

Key features

At a glance

- Compact and sturdy design
- Components with numerous individual functions form a single unit
- Extremely short switching times thanks to integrated solenoid valves
- No external or additional components required
- Easily fitted thanks to compact dimensions and therefore particularly suitable for handling tasks
- Cost effective assembly as the solenoid valve, vacuum generator and silencer are all in a single unit
- Degree of protection IP65
- With manual override
- With integrated silencer for reducing exhaust noise
- With integrated filter for the air to be evacuated and an inspection window which shows the degree of filter contamination
- With or without integrated vacuum switch to monitor the vacuum with PNP or NPN output
- With 2 vacuum ports, optional

Vacuum generator VADM



The compressed air supply for these vacuum generators is controlled by the integrated solenoid valve. When the power supply is switched on, the valve is actuated and the flow of compressed air generates a vacuum at the vacuum ports using the ejector principle. Suction stops when the power supply to the valve is switched off. The integrated silencer reduces exhaust noise to a minimum. With the vacuum generators VADM-...-P/N the vacuum can be monitored using a vacuum switch.

- Integrated solenoid valve for:
 - Vacuum ON/OFF

Vacuum generator VADMI with ejector pulse



Compressed air enters the vacuum generator when a voltage signal is applied to the integrated solenoid valve, thereby creating a vacuum. Once the voltage is switched off at the vacuum valve and switched on at the ejector pulse valve, the vacuum is rapidly purged at port 2 as a result of the application of pressure. The integrated silencer reduces exhaust noise to a minimum. With the vacuum generators VADMI-...-P/-N, the vacuum can be monitored using a vacuum switch.

- Two integrated solenoid valves for:
 - Vacuum ON/OFF
 - Ejector pulse
- With sensing interface
- With integrated check valve as safety function
- Air saving function possible in combination with a vacuum switch and a higher-level logic circuit (e.g. PLC)

Vacuum generator VADMI-...-LS with ejector pulse and air-saving function

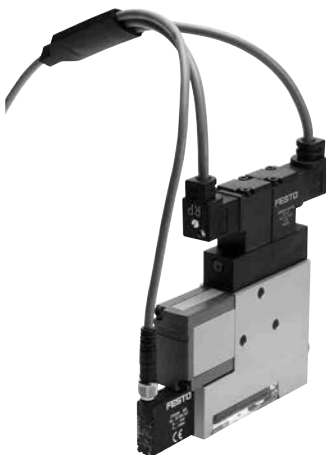

This vacuum generator has an identical design to the other VADMI types. This ejector also has an integrated vacuum switch with air saving function: If the pressure drops below the set vacuum range, vacuum generation is switched on automatically.

- Two integrated solenoid valves for:
 - Vacuum ON/OFF
 - Ejector pulse
- With sensing interface
- With integrated check valve as safety function
- Vacuum switch for pressure monitoring
- Integrated air saving function
- Cable kit with plug sockets for solenoid coils and vacuum switches included in the scope of delivery

Key features

Air-saving function with VADMI-...-P/N and external controller

Conventional vacuum switching → A cost-effective energy saving measure

The vacuum range for holding the workpiece is set on the vacuum switch using the two potentiometers. The lower limit defines the minimum value.

Provided the vacuum level is within this range, reliable workpiece transport is guaranteed.

The vacuum generator VADMI is only activated by the external controller if the level drops below the minimum value and is deactivated again once the maximum value is regained.

A check valve prevents the vacuum level from being reduced during the inactive phase of vacuum generation.

The functional sequence

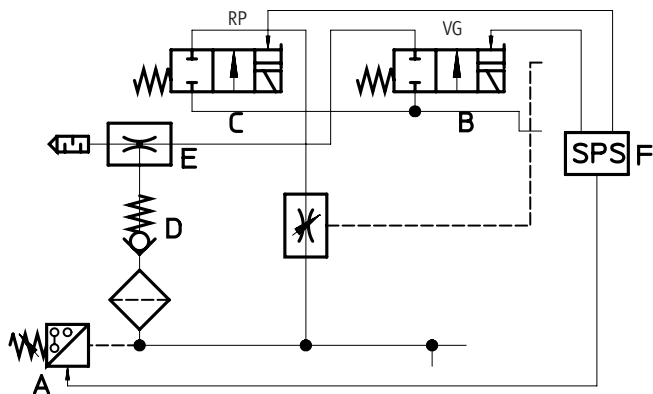
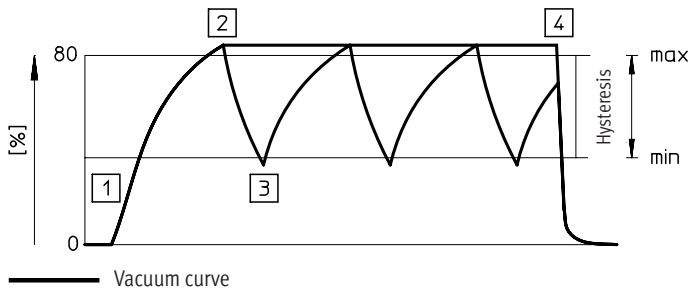

- | | |
|-------------------------------------|--------------------|
| RP Solenoid valve for ejector pulse | E Vacuum generator |
| VG Solenoid valve for vacuum ON/OFF | D Check valve |
| | C Ejector pulse |
| | A Vacuum switch |

Vacuum on

- [1] External controller F switches on the VG solenoid
 - Valve for compressed air supply B open
 - Vacuum generation E is activated

Vacuum stop

- [2] The specified maximum level is achieved:
 - Vacuum switch A sends signal to external controller F
 - Controller switches VG magnet off
 - Vacuum generation E interrupted
 - Check valve D prevents reduction in the vacuum level

Vacuum on

- [3] Leakage causes the vacuum level to drop to the minimum value
 - Vacuum switch A sends signal to external controller F
 - Controller F switches VG magnet back on
 - Vacuum generation E active again
 - Constant repetition of points 2 and 3

Cycle ended: vacuum off

- [4] Transport process ended
 - External controller F deactivates VG magnet
 - Vacuum generation E is ended
 - External controller F switches RP magnet
 - Ejector pulse C activated
 - Workpiece is set down

Key features

Air-saving function and fault signal with VADMI-...-LS-P/N

The further development of the vacuum switch

When combined with the supplied cable kit, the vacuum generator VADMI-...-LS-P/N has an air saving function. The vacuum range for holding the workpiece is set on the vacuum switch using the two potentiometers. The vacuum switch generates a pulsating signal which only actuates the solenoid for vacuum ON/OFF in the vacuum generator when the vacuum has fallen below the minimum value, for example due to leakage. At all other times, the vacuum is maintained with the help of the check valve, even when the vacuum generator is not switched on. In addition, a status signal A1 can be interrogated which is connected to +24 V during normal operation, but which is switched to 0 whenever vacuum again falls below the critical value by 150 mbar due to a malfunction. This is the case, for example, if the workpiece has dropped off from the suction gripper and it is therefore no longer possible to generate the selected vacuum range.

The three control and supply cable harnesses are combined in one branch. Just one cable containing one signal wire and three power supply wires is routed from the branch to the PLC.

Given the decentralised control of the switching function, external actuation of the vacuum switching (air saving function) would be superfluous. As a result there is significantly less wiring.

Note
The vacuum switch may only be operated with the included cable kit.

The functional sequence

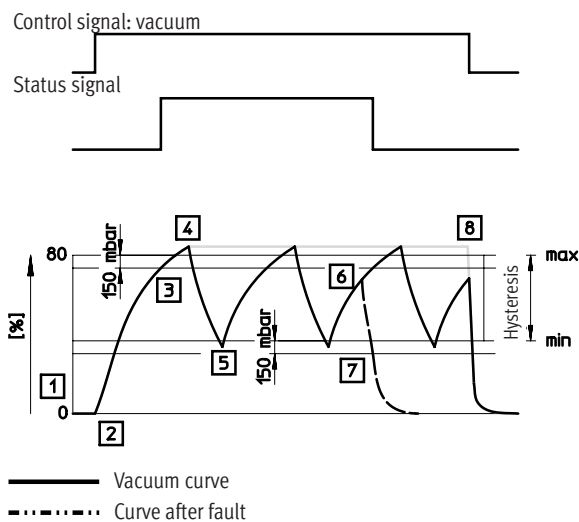

Start signal

- [1] External controller F activates the vacuum switch
 - Vacuum switch A checks vacuum status
 - No vacuum present

Vacuum on

- [2] Vacuum switch activates the VG solenoid
 - Valve for compressed air supply B open
 - Vacuum generation E is activated
- [3] Vacuum level exceeds 150 mbar below the maximum level
 - Vacuum switch sends release signal to external controller F
 - Transport process can start

Vacuum stop

- [4] The specified maximum level is achieved
 - Vacuum switch A switches VG magnet off
 - Compressed air supply stopped
 - Vacuum generation E interrupted
 - Check valve D prevents reduction in the vacuum level

Vacuum on

- [5] Leakage causes the vacuum level to drop to the minimum value
 - Vacuum switch A switches VG magnet back on
 - Vacuum generation E active again

Fault: transport stop

- [6] Major leakage causes an overly large drop in the vacuum level
 - Vacuum generator E cannot compensate for the drop in level
- [7] Vacuum level falls to 150 mbar below the minimum value
 - Vacuum switch A sends error message to external controller F
 - External controller F cancels transport process
 - Vacuum generation E is ended

Cycle ended: vacuum off

- [8] Transport process terminated
 - External controller F deactivates VG magnet
 - Vacuum generation E is ended
 - External controller F switches RP magnet
 - Ejector pulse C activated
 - Workpiece is set down

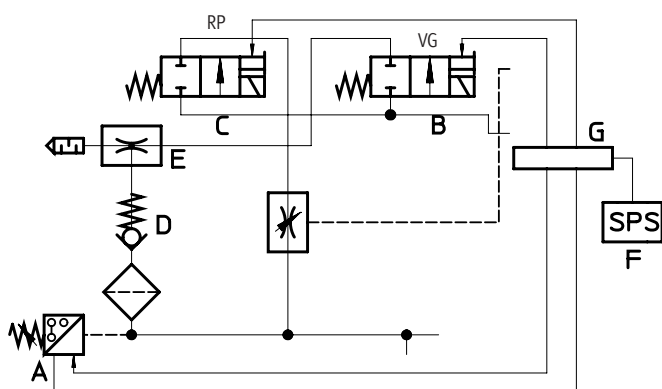

- | | |
|-------------------------------------|--------------------|
| RP Solenoid valve for ejector pulse | E Vacuum generator |
| VG Solenoid valve for vacuum ON/OFF | D Check valve |
| | C Ejector pulse |
| | G Branch |
| | A Vacuum switch |

Peripherals overview

VADM/VADMI-45/70

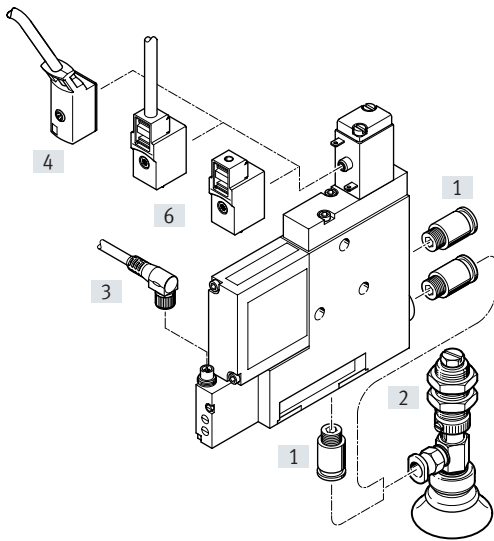

VADM/VADMI-95/140/200/300

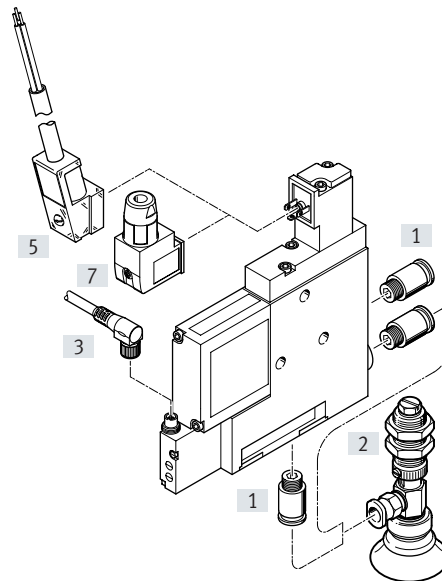

Mounting attachments and accessories

	VADM/VADMI-45/70	VADM/VADMI-95/140/200/300	→ Page/Internet
[1] Push-in fitting QS	■	■	qs
[2] Suction gripper ESG	■	■	esg
[3] Connecting cable NEBU-M8G4/M8W4	■	■	19
[4] Connecting cable KMYZ-2	■	–	19
[5] Plug socket with cable KMEB-1/2	–	■	19
[6] Plug socket MSSD-ZBZC	■	–	19
[7] Plug socket MSSD-EB	–	■	19
– Suction cup holder ESH	■	■	esh
– Suction cup ESS	■	■	ess
– Illuminating seal MEB-LD	–	■	19

Type codes



001	Series	
VADMI	Vacuum generator with ejector pulse	
VADM	Vacuum generator without ejector pulse	

002	Nominal width of Laval nozzle	
45	0.45 mm	
70	0.7 mm	
95	0.95 mm	
140	1.4 mm	
200	2.0 mm	
300	3.0 mm	

003	Air reduction	
	None	
LS	With air saving circuit	

004	Output signal vacuum sensor	
	Without vacuum sensor	
P	With 1 switching output PNP	
N	With 1 switching output NPN	

Datasheet

-  Temperature range
0 ... +60°C
-  Operating pressure
1.5 ... 8 bar
-  www.festo.com

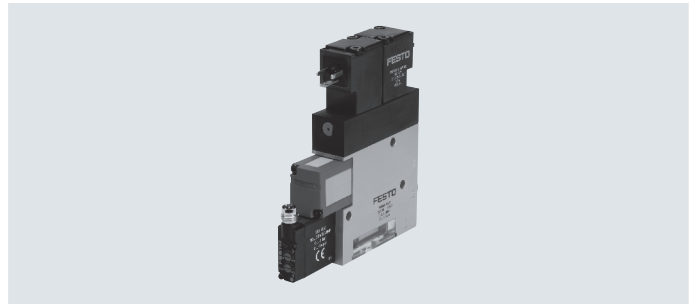
General technical data

Type	VADM/VADMI						
	-45	-70	-95	-140	-200	-300	
Nominal width of Laval nozzle	[mm]	0.45	0.7	0.95	1.4	2.0	3.0
Grid dimension	[mm]	10	15	18	22	22	22
Grade of filtration	[µm]	≤40					
Mounting position	Any						
Type of mounting	With through-hole						
	Via female thread						
Pneumatic connection 1 (P)		M5	M5	G1/8	G1/8	G1/4	G1/4
Vacuum port (V)		M5	G1/8	G1/8	G1/4	G3/8	G3/8
Pneumatic connection 3 (R)	Integrated silencer						

Technical data – design

Type	VADM	VADMI
Ejector characteristic	High vacuum	
Silencer design	Closed	
Integrated function	On/off valve, electric	
	Filter	
	-	
	Flow control valve	
	Electric ejector pulse valve	
	Check valve	
	-P/-N	Vacuum switch
-LS-P/-N	-	
	Air saving function, electric	
	Vacuum switch	
Valve function	Closed	
Manual override	Non-detenting	

Datasheet

Operating and environmental conditions					
Type		VADM/VADMI			
		Without vacuum switch -45/70		With vacuum switch -P/N -45/70	
		-95/140/200/300	-95/140/200/300	-95/140/200/300	-95/140/200/300
Operating pressure	[MPa]	0.15 ... 0.8	0.2 ... 0.8	0.15 ... 0.8	0.2 ... 0.8
	[bar]	1.5 ... 8	2 ... 8	1.5 ... 8	2 ... 8
	[psi]	21.75 ... 116	29 ... 116	21.75 ... 116	29 ... 116
Nominal operating pressure	[MPa]	0.6			
	[bar]	6			
	[psi]	87			
Max. overload pressure	[bar]	-		5 (VADMI only)	
Operating medium		Compressed air to ISO 8573-1:2010 [7:4:4]			
Note on the operating/pilot medium		Lubricated operation not possible			
LABS (PWIS) conformity		VDMA24364-B1/B2-L			
Ambient temperature	[°C]	0 ... +60		0 ... +50	
Temperature of medium	[°C]	0 ... +60			
Corrosion resistance class CRC ¹⁾		2			
CE marking (see declaration of conformity)		-		To EU EMC Directive ²⁾	
UKCA marking (see declaration of conformity)		-		To UK EMC regulations ²⁾³⁾	
Approval		c UL us - Recognized (OL)			
		-		RCM	

1) Corrosion resistance class CRC 2 to Festo standard FN 940070

Moderate corrosion stress. Indoor applications in which condensation can occur. External visible parts with primarily decorative surface requirements that are in direct contact with a normal industrial environment.

2) Additional information: www.festo.com/catalogue/vadm → Support/Downloads.

3) Only applies to VADMI.

Performance data – high vacuum													
Type		VADM						VADMI ²⁾					
		-45	-70	-95	-140	-200	-300	-45	-70	-95	-140	-200	-300
Max. vacuum	[%]	85						85					
Ventilation time ¹⁾ at nominal operating pressure	[s]	5.9	2.2	1.18	0.69	0.29	0.26	1.9	0.59	2.04	0.19	0.15	0.2

1) Time required to reduce the vacuum from nominal operating pressure to -0.05 bar.

2) With ejector pulse

Technical data – electrical connection	
Electrical connection	Plug
Operating voltage range	[V DC] 21.6 ... 26.4
Duty cycle	[%] 100
Degree of protection	IP65

Datasheet

Technical data – Vacuum switch			
Type	VADM/VADMI	-N	VADMI
	-P		-LS-P
			-LS-N
Mechanical system			
Electrical connection	Plug M8x1, 4-pin		
Measured variable	Relative pressure		
Measuring principle	Piezoresistive		
Pressure measuring range	[MPa]	0 ... 0.1	
	[bar]	0 ... 1	
	[psi]	0 ... 14.5	
Setting options	Potentiometer		
Threshold value setting range	[kPa]	-90 ... 0	-90 ... -20
	[bar]	-0.9 ... 0	-0.9 ... -0.2
	[psi]	-13.05 ... 0	-13.05 ... -2.9
Hysteresis setting range	[kPa]	-50 ... -5	-60 ... -10
	[bar]	-0.5 ... -0.05	-0.6 ... -0.1
	[psi]	-7.25 ... -0.725	-8.7 ... -1.45
Display type	LED		
Switching status indication	Optical		
Electrical system			
Operating voltage range	[V DC]	15 ... 30	
Switching output		PNP	NPN
Switching element function	N/O		
Switching function	Threshold-comparator		
Reverse polarity protection	For all electrical connections		

Vacuum switch control panel

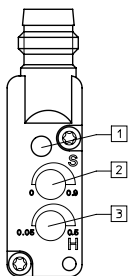

- [1] Switching status indication, yellow LED
- [2] Potentiometer for setting threshold values
- [3] Potentiometer for setting hysteresis

Datasheet

Weight [g] Type	VADM						VADMI					
	-45	-70	-95	-140	-200	-300	-45	-70	-95	-140	-200	-300
Without vacuum switch	60	140	210	290	320	340	85	170	240	320	350	370
With vacuum switch -P/-N	65	145	220	300	330	350	90	180	250	330	360	380

Materials	
Housing	Wrought aluminium alloy
Filter casing	PC
Silencer	PE, POM
Piston	POM
Jet nozzle	Nickel-plated brass
Collector nozzle	Nickel-plated brass
Filter	PA
Seals	NBR
Note on materials	Free of copper and PTFE

Vacuum Δp_U as a function of operating pressure p

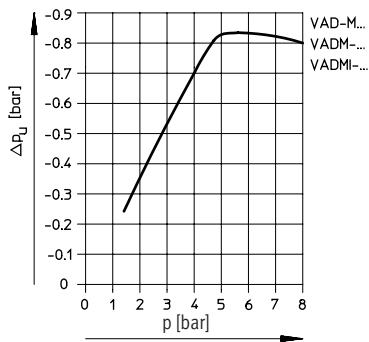

Evacuation time t [s] for 1 litre volume at 6 bar operating pressure

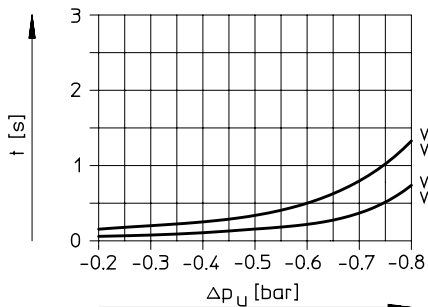
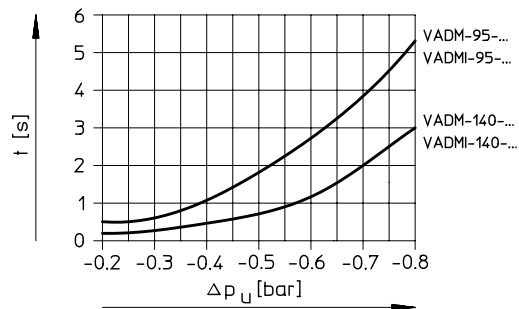
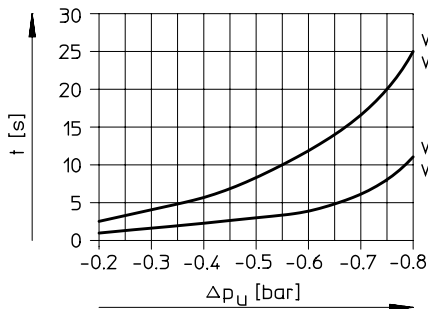

Datasheet

Air consumption Q as a function of operating pressure p

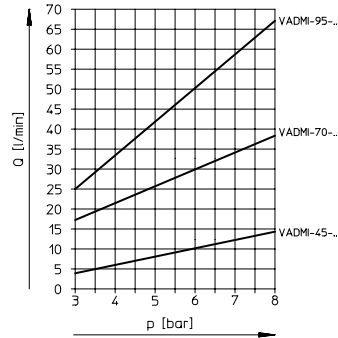
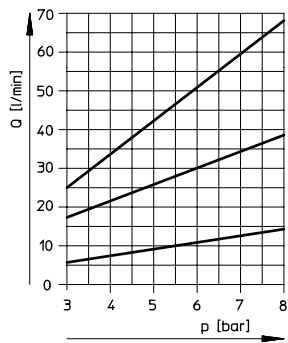

Noise level Lp as a function of operating pressure p (without suction flow)

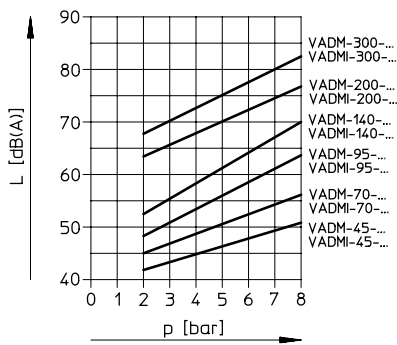

Efficiency η as a function of vacuum Δp_u at P_{nom} 6 bar

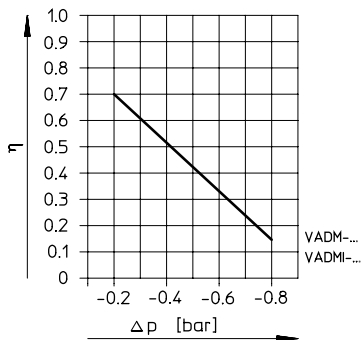

Suction volume flow qn as a function of vacuum Δp_u at P_{nom} 6 bar

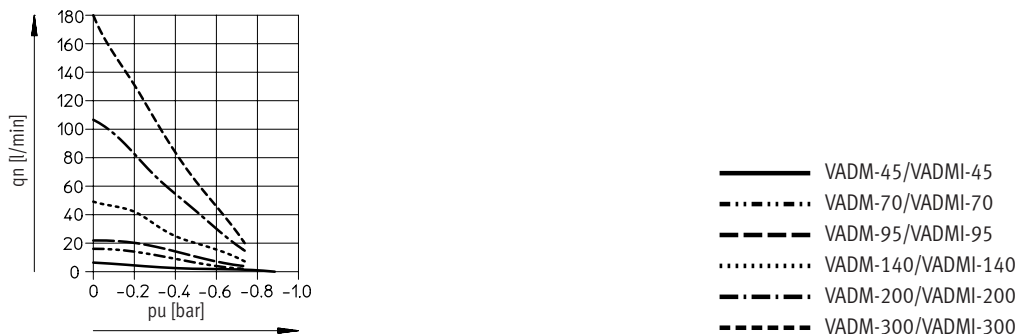

Datasheet

Dimensions

VADM-45/70

VADM-95/140/200/300

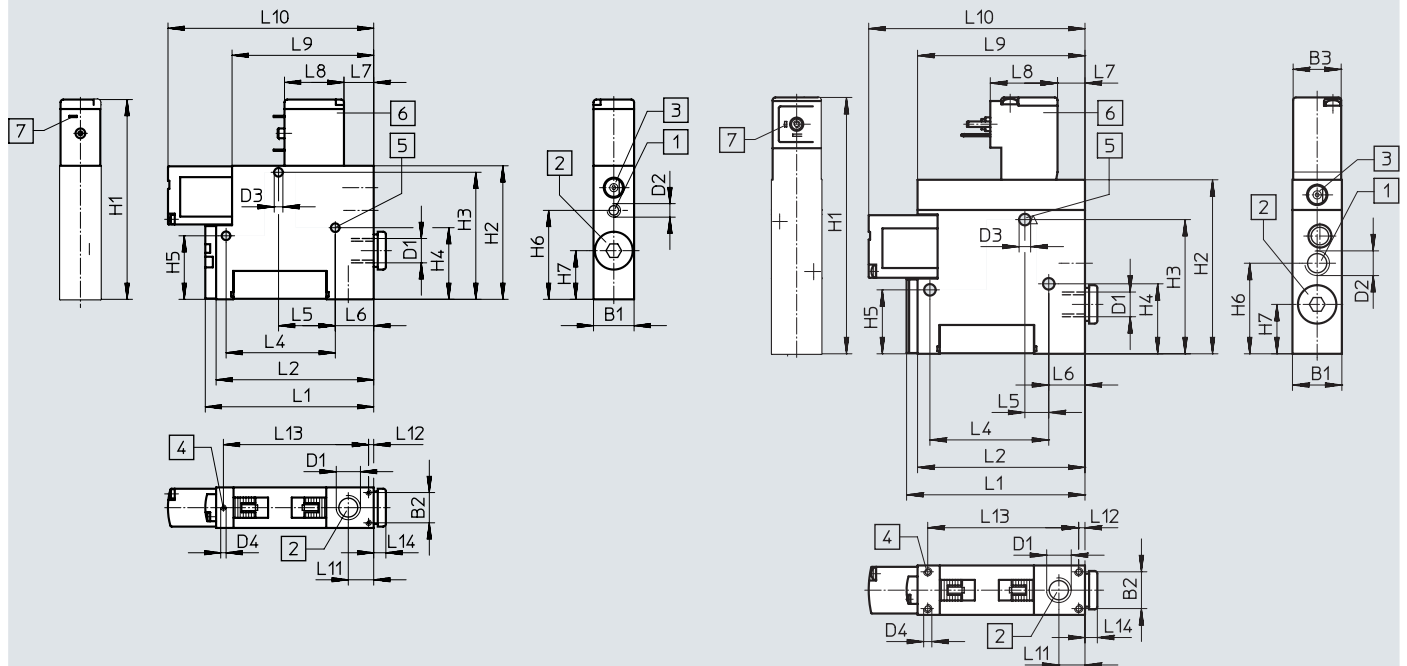

- [1] Compressed air supply port
- [2] Vacuum port
- [3] Manual override
- [4] Mounting thread
- [5] Mounting hole
- [6] Solenoid coil can be rotated 180°
- [7] Suitable plug-socket for
 - VADM-45/70:
 - KMYZ → page 19
 - MSSD-ZBZC → page 19
 - VADM-95/140/200/300:
 - KMEB → page 19
 - MSSD-EB → page 19

Type	B1	B2	B3	D1	D2	D3 ∅	D4	H1	H2	H3	H4	H5	H6	H7
VADM-45	10	6.2	–	M5	M5	3.2	M2	64.4	44.4	40.8	23.8	23.8	29.6	18
VADM-70	15	11.2	–	G1/8	M5	3.2	M2	73.9	49.4	47	26.5	23.5	32.9	18
VADM-95	18	13.4	18	G1/8	G1/8	4.2	M2.5	93.4	63.4	48.9	25.5	23.3	33	18
VADM-140	22	16.6	18	G1/4	G1/8	5.2	M3	107.4	77.4	61.4	41.4	41.4	36	17.5
VADM-200	22	16.6	18	G3/8	G1/4	5.2	M3	113.4	83.4	67.7	41.4	41.4	40	19
VADM-300	22	16.6	18	G3/8	G1/4	5.2	M3	113.4	83.4	67.7	41.4	41.4	40	19

Type	L1	L2	L4	L5	L6	L7	L8	L9	L10	L11	L12	L13	L14
VADM-45	45	41	33.6	25	3.6	11	16	41	56	7.9	1.9	36.3	4
VADM-70	62.3	58.3	40.4	21	14.2	11	22	52.4	76.1	9.4	1.9	53.7	4.5
VADM-95	65	61	43.3	8.7	13.2	9.7	24.5	61	78.8	9.5	2.3	55	4.5
VADM-140	88	84	26	12.5	28.5	9.7	24.5	61	96.8	13.8	2.3	79.4	5
VADM-200	88	84	26	12.5	28.5	9.7	24.5	61	101.8	12.5	2.3	79.4	5
VADM-300	124.4	120.4	26	12.5	28.5	9.7	24.5	61	137.4	12.5	2.3	115.8	5

† Note: This product corresponds to ISO 1179-1 and ISO 228-1.

Datasheet

Dimensions

VADM-45/70-P/N

VADM-95/140/200/300-P/N

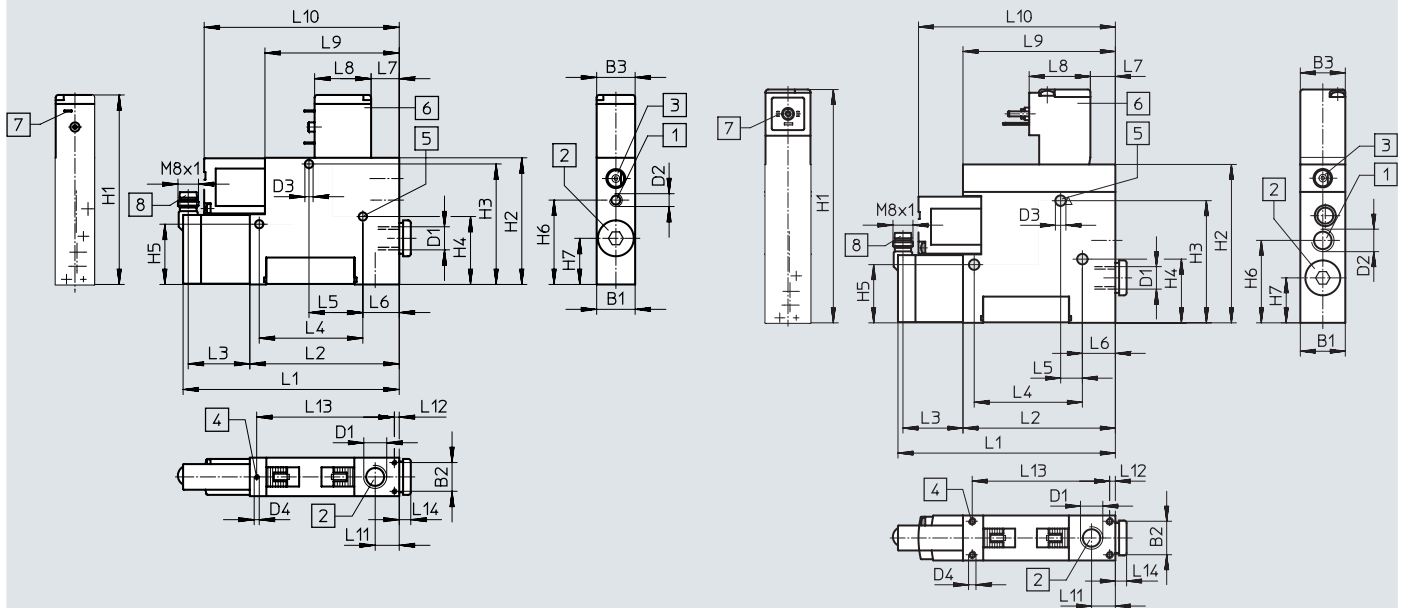

- [1] Compressed air supply port
- [2] Vacuum port
- [3] Manual override
- [4] Mounting thread
- [5] Mounting hole
- [6] Solenoid coil can be rotated 180°
- [7] Suitable plug-socket for
 - VADM-45/70:
 - KMYZ → page 19
 - MSSD-ZBZC → page 19
 - VADM-95/140/200/300:
 - KMEB → page 19
 - MSSD-EB → page 19
- [8] Connection for connecting cable
NEBU-M8G4/M8W4
→ page 19

Type	B1	B2	B3	D1	D2	D3 ∅	D4	H1	H2	H3	H4	H5	H6	H7
VADM-45-P/N	10	6.2	10	M5	M5	3.2	M2	64.4	44.4	40.8	23.8	23.8	29.6	18
VADM-70-P/N	15	11.2	15	G1/8	M5	3.2	M2	73.9	49.4	47	26.5	23.5	32.9	18
VADM-95-P/N	18	13.4	18	G1/8	G1/8	4.2	M2.5	93.4	63.4	48.9	25.5	23.3	33	18
VADM-140-P/N	22	16.6	18	G1/4	G1/8	5.2	M3	107.4	77.4	61.4	41.4	41.4	36	17.5
VADM-200-P/N	22	16.6	18	G3/8	G1/4	5.2	M3	113.4	83.4	67.7	41.4	41.4	40	19
VADM-300-P/N	22	16.6	18	G3/8	G1/4	5.2	M3	113.4	83.4	67.7	41.4	41.4	40	19

Type	L1	L2	L3	L4	L5	L6	L7	L8	L9	L10	L11	L12	L13	L14
VADM-45-P/N	71.4	41	28.4	33.6	25	3.6	11	16	41	56	7.9	1.9	36.3	4
VADM-70-P/N	88.7	58.3	28.4	40.4	21	14.2	11	22	52.4	76.1	9.4	1.9	53.7	4.5
VADM-95-P/N	91.4	61	28.4	43.3	8.7	13.2	9.7	24.5	61	78.8	9.5	2.3	55	4.5
VADM-140-P/N	114.4	84	28.4	26	12.5	28.5	9.7	24.5	61	96.8	13.8	2.3	79.4	5
VADM-200-P/N	114.4	84	28.4	26	12.5	28.5	9.7	24.5	61	101.8	12.5	2.3	79.4	5
VADM-300-P/N	150.8	120.4	28.4	26	12.5	28.5	9.7	24.5	61	137.4	12.5	2.3	115.8	5

† Note: This product corresponds to ISO 1179-1 and ISO 228-1.

Datasheet

Dimensions

VADMI-45/70

VADMI-95/140/200/300

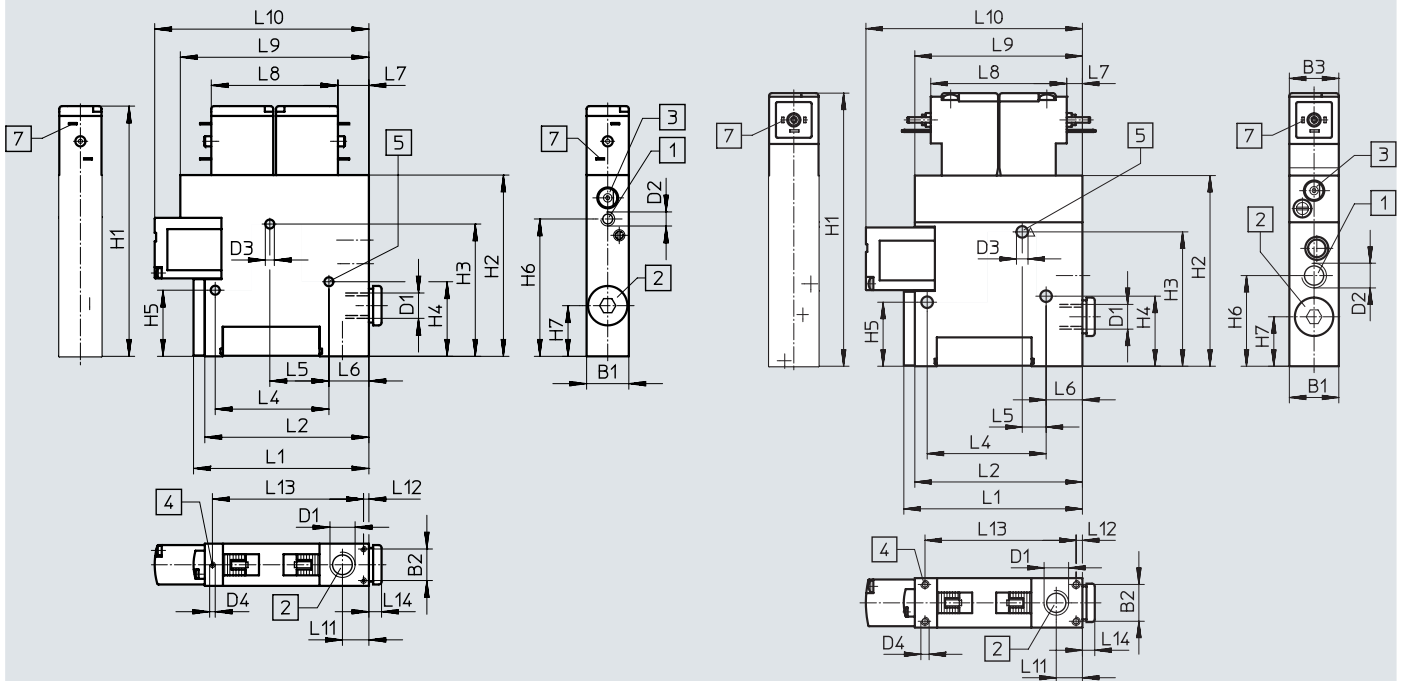

- [1] Compressed air supply port
- [2] Vacuum port
- [3] Manual override
- [4] Mounting thread
- [5] Mounting hole
- [7] Suitable plug-socket for
 - VADMI-45/70:
 - KMYZ → page 19
 - MSSD-ZBZC → page 19
 - VADMI-95/140/200/300:
 - KMEB → page 19
 - MSSD-EB → page 19

Type	B1	B2	B3	D1	D2	D3 ∅	D4	H1	H2	H3	H4	H5	H6	H7
VADMI-45	10	6.2	–	M5	M5	3.2	M2	78.2	58.2	40.8	23.8	23.8	43.4	18
VADMI-70	15	11.2	–	G1/8	M5	3.2	M2	88.9	64.4	47	26.5	23.5	48.8	18
VADMI-95	18	13.4	18	G1/8	G1/8	4.2	M2.5	99.4	69.4	48.9	25.5	23.3	33	18
VADMI-140	22	16.6	18	G1/4	G1/8	5.2	M3	113.4	83.4	61.4	41.4	41.4	36	17.5
VADMI-200	22	16.6	18	G3/8	G1/4	5.2	M3	119.4	89.4	67.7	41.4	41.4	40	19
VADMI-300	22	16.6	18	G3/8	G1/4	5.2	M3	119.4	89.4	67.7	41.4	41.4	40	19

Type	L1	L2	L4	L5	L6	L7	L8	L9	L10	L11	L12	L13	L14
VADMI-45	45	41	33.6	25	3.6	11	33	55	56	7.9	1.9	36.3	4
VADMI-70	62.3	58.3	40.4	21	14.2	11	45	67	76.1	9.4	1.9	53.7	4.5
VADMI-95	65	61	43.3	8.7	13.2	5.7	49.5	61	78.8	9.5	2.3	55	4.5
VADMI-140	88	84	26	12.5	28.5	5.7	49.5	61	96.8	13.8	2.3	79.4	5
VADMI-200	88	84	26	12.5	28.5	5.7	49.5	61	101.8	12.5	2.3	79.4	5
VADMI-300	124.4	120.4	26	12.5	28.5	5.7	49.5	61	137.4	12.5	2.3	115.8	5

† Note: This product corresponds to ISO 1179-1 and ISO 228-1.

Datasheet

Dimensions

VADMI-45/70(-LS)-P/N

VADMI-95/140/200/300(-LS)-P/N

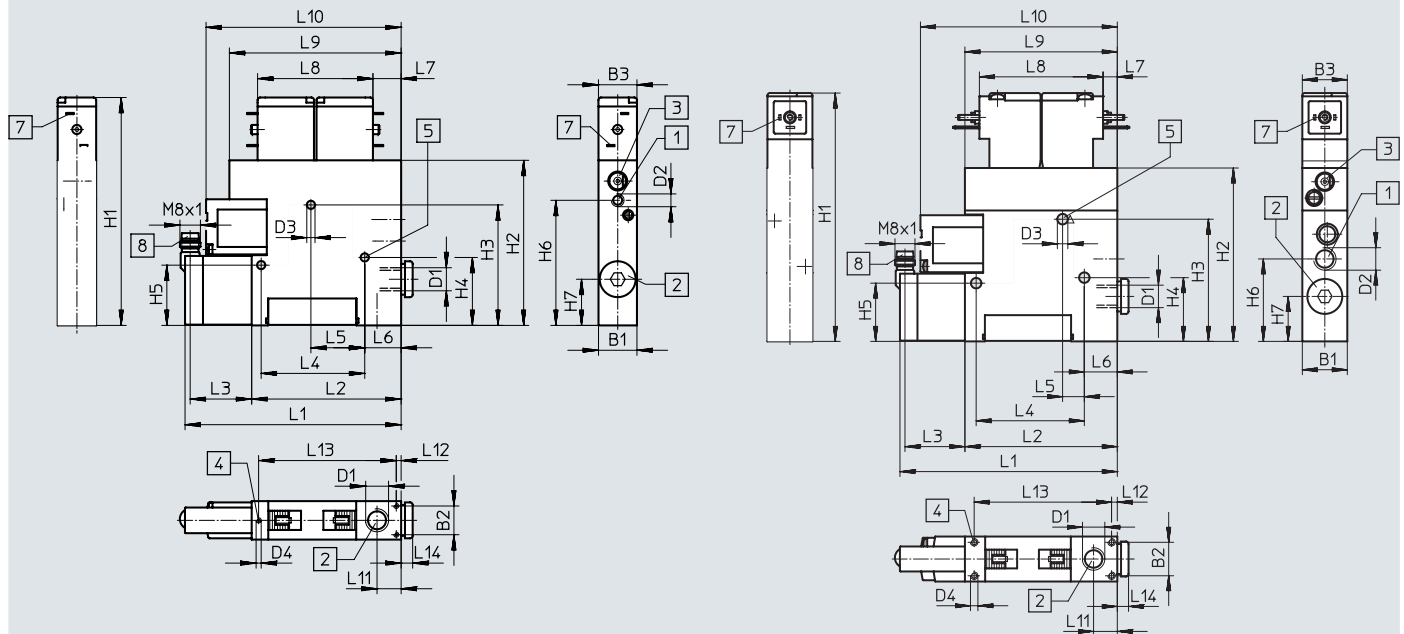

- [1] Compressed air supply port
- [2] Vacuum port
- [3] Manual override
- [4] Mounting thread
- [5] Mounting hole
- [7] Suitable plug-socket for
 - VADMI-45/70:
 - KMYZ → page 19
 - MSSD-ZBZC → page 19
- [8] Connection for connecting cable
 - VADMI-95/140/200/300:
 - KMEB →
 - MSSD-EB → page 19

Type	B1	B2	B3	D1	D2	D3 ∅	D4	H1	H2	H3	H4	H5	H6	H7
VADMI-45(-LS)-P/N	10	6.2	10	M5	M5	3.2	M2	78.2	58.2	40.8	23.8	23.8	43.4	18
VADMI-70(-LS)-P/N	15	11.2	15	G1/8	M5	3.2	M2	88.9	64.4	47	26.5	23.5	48.8	18
VADMI-95(-LS)-P/N	18	13.4	18	G1/8	G1/8	4.2	M2.5	99.4	69.4	48.9	25.5	23.3	33	18
VADMI-140(-LS)-P/N	22	16.6	18	G1/4	G1/8	5.2	M3	113.4	83.4	61.4	41.4	41.4	36	17.5
VADMI-200(-LS)-P/N	22	16.6	18	G3/8	G1/4	5.2	M3	119.4	89.4	67.7	41.4	41.4	40	19
VADMI-300(-LS)-P/N	22	16.6	18	G3/8	G1/4	5.2	M3	119.4	89.4	67.7	41.4	41.4	40	19

Type	L1	L2	L3	L4	L5	L6	L7	L8	L9	L10	L11	L12	L13	L14
VADMI-45(-LS)-P/N	71.4	41	28.4	33.6	25	3.6	11	33	55	56	7.9	1.9	36.3	4
VADMI-70(-LS)-P/N	88.7	58.3	28.4	40.4	21	14.2	11	45	67	76.1	9.4	1.9	53.7	4.5
VADMI-95(-LS)-P/N	91.4	61	28.4	43.3	8.7	13.2	5.7	49.5	61	78.8	9.5	2.3	55	4.5
VADMI-140(-LS)-P/N	114.4	84	28.4	26	12.5	28.5	5.7	49.5	61	96.8	13.8	2.3	79.4	5
VADMI-200(-LS)-P/N	114.4	84	28.4	26	12.5	28.5	5.7	49.5	61	101.8	12.5	2.3	79.4	5
VADMI-300(-LS)-P/N	150.8	120.4	28.4	26	12.5	28.5	5.7	49.5	61	137.4	12.5	2.3	115.8	5

† Note: This product corresponds to ISO 1179-1 and ISO 228-1.

Datasheet



Ordering data							
Size	Solenoid coils	Without vacuum switch		With vacuum switch		NPN output	
		Part no.	Type	Part no.	Type	Part no.	Type
Without ejector pulse							
45	MZB	162500	VADM-45	162512	VADM-45-P	162513	VADM-45-N
70	MYB	162501	VADM-70	162514	VADM-70-P	162515	VADM-70-N
95	MEB	162502	VADM-95	162516	VADM-95-P	162517	VADM-95-N
140	MEB	162503	VADM-140	162518	VADM-140-P	162519	VADM-140-N
200	MEB	162504	VADM-200	162520	VADM-200-P	162521	VADM-200-N
300	MEB	162505	VADM-300	162522	VADM-300-P	162523	VADM-300-N
With ejector pulse							
45	MZB	162506	VADMI-45	162524	VADMI-45-P	162525	VADMI-45-N
70	MYB	162507	VADMI-70	162526	VADMI-70-P	162527	VADMI-70-N
95	MEB	162508	VADMI-95	162528	VADMI-95-P	162529	VADMI-95-N
140	MEB	162509	VADMI-140	162530	VADMI-140-P	162531	VADMI-140-N
200	MEB	162510	VADMI-200	162532	VADMI-200-P	162533	VADMI-200-N
300	MEB	162511	VADMI-300	162534	VADMI-300-P	162535	VADMI-300-N
With ejector pulse and air saving function							
45	MZB	-		171053	VADMI-45-LS-P	171054	VADMI-45-LS-N
70	MYB	-		171055	VADMI-70-LS-P	171056	VADMI-70-LS-N
95	MEB	-		171057	VADMI-95-LS-P	171058	VADMI-95-LS-N
140	MEB	-		171059	VADMI-140-LS-P	171060	VADMI-140-LS-N
200	MEB	-		171061	VADMI-200-LS-P	171062	VADMI-200-LS-N
300	MEB	-		171063	VADMI-300-LS-P	171064	VADMI-300-LS-N

 **Note**



For vacuum generators VADMI-...-LS-P/N, the cable kit with plug sockets for solenoid coils and vacuum switches is included in the scope of delivery.

These vacuum generators may only be operated with the cable supplied.

Accessories

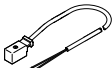
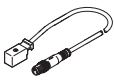
Ordering data – Plug socket MSSD					Datasheets → Internet: mssd	
	Description	Electrical connection	Cable connection	Part no.	Type	
	For VADM/ VADMI-45/70	Angled socket	Insulation displacement connector	185521	MSSD-ZBZC	
	For VADM/ VADMI-95/ 140/200/300	Angled socket, 3-pin, type C, to EN 175301-803	Screw terminal PG7	151687	MSSD-EB	
			Screw terminal M12	539712	MSSD-EB-M12	
		Angled socket, 4-pin, type C	Insulation displacement connector M14	192745	MSSD-EB-S-M14	

Ordering data – Connecting cable KMYZ-2					Datasheets → Internet: kmyz		
	Description	Electrical connection	Switching status indication	Cable length [m]	Part no.	Type	
	For VADM/ VADMI-45/70	Angled socket, 2-pin, square design	Open cable end	LED	2.5	34997	KMYZ-2-24-2.5-LED
					5	34998	KMYZ-2-24-5-LED
				LED	10	193443	KMYZ-2-24-10-LED
			Straight plug, 3-pin, M8x1	LED	0.5	177676	KMYZ-2-24-M8-0.5-LED
					2.5	177678	KMYZ-2-24-M8-2.5-LED

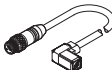
Ordering data – Plug socket with cable KMEB					Datasheets → Internet: kmeb		
	Description	Electrical connection	Switching status indication	Cable length [m]	Part no.	Type	
	For VADM/ VADMI-95/ 140/200/300	Angled socket, 3-pin, type C, to EN 175301-803	Open cable end	LED	2.5	151688	KMEB-1-24-2.5-LED
					5	151689	KMEB-1-24-5-LED
					10	193457	KMEB-1-24-10-LED
		Angled socket, 4-pin, type C, to EN 175301-803	Open cable end	LED	2.5	174844	KMEB-2-24-2.5-LED
					5	174845	KMEB-2-24-5-LED
		Angled socket, 5-pin, type C, to EN 175301-803	Straight plug, 5-pin, M12x1	LED	0.5	177677	KMEB-2-24-M12-0.5-LED

Ordering data – Illuminating seal MEB-LD			Datasheets → Internet: meb	
	Description		Part no.	Type
	For plug socket with cable KMEB and plug socket MSSD-EB		151717	MEB-LD-12-24DC

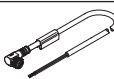
Ordering data – Connecting cable NEBU-M8				Datasheets → Internet: nebu	
	Electrical connection		Cable length [m]	Part no.	Type
	Straight socket, M8x1, 4-pin	Open cable end	2.5	541342	NEBU-M8G4-K-2.5-LE4
			5	541343	NEBU-M8G4-K-5-LE4
			9	8003130	NEBU-M8G4-K-9-LE4
	Angled socket, M8x1, 4-pin	Open cable end	2.5	541344	NEBU-M8W4-K-2.5-LE4
			5	541345	NEBU-M8W4-K-5-LE4
			10	575833	NEBU-M8W4-K-10-LE4

Festo - Your Partner in Automation



1 Festo Inc.
5300 Explorer Drive
Mississauga, ON L4W 5G4
Canada

Festo Customer Interaction Center
Tel: 1 877 463 3786
Fax: 1 877 393 3786
Email: customer.service.ca@festo.com



2 Festo Pneumatic
Av. Ceylán 3,
Col. Tequesquináhuac
54020 Tlalnepantla,
Estado de México

Multinational Contact Center
01 800 337 8669
ventas.mexico@festo.com



3 Festo Corporation
1377 Motor Parkway
Suite 310
Islandia, NY 11749

Festo Customer Interaction Center
1 800 993 3786
1 800 963 3786
customer.service.us@festo.com



4 Regional Service Center
7777 Columbia Road
Mason, OH 45040

Connect with us



www.festo.com/socialmedia



www.festo.com

Subject to change