

Click to
ORDER
samples

AMESP600-MNZ

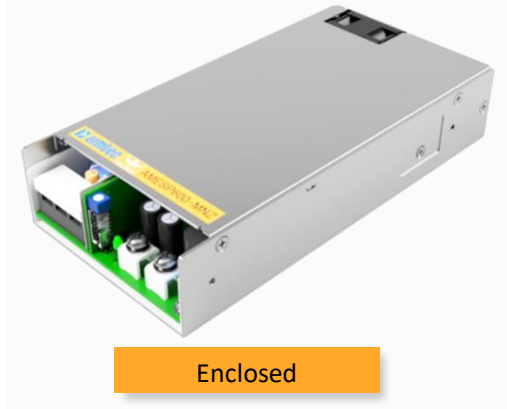

Enclosed

The AMESP600-MNZ is Aimtec's eagle series AC/DC power supply that offers greater cost effectiveness due to material normalization and production automation also leading to improved reliability and performance. Offering a commercial input voltage range of 80-277VAC and an output voltage range from 12-48V, this series will offer many benefits to your new system design.

This new series offers great operating temperatures, from -40°C to 50°C with full power and also features an isolation of 4000VAC for improved reliability and system safety. Furthermore, a high MTBF of over 300,000h, output short circuit protection (OSCP), output over-current protection (OCP), output over-voltage protection (OVP) and over-temperature protection (OTP) come standard with the series.

The AMESP600-MNZ is suitable for grid power, ATM machine, instrumentation, industrial controls, telecommunication and medical equipment applications.

Features

- Universal Input: 80 - 277VAC/110 - 390VDC
- Operating Temp: -40 °C to +70 °C
- High isolation voltage: Up to 4000VAC
- Low ripple & noise, 150mV(p-p) typ.
- Remote sense compensation, remote ON/OFF function
- Output short circuit, over-current, over-voltage and over temperature protection
- Regulated Output
- Active power factor correction, PFC > 0.95

Summary

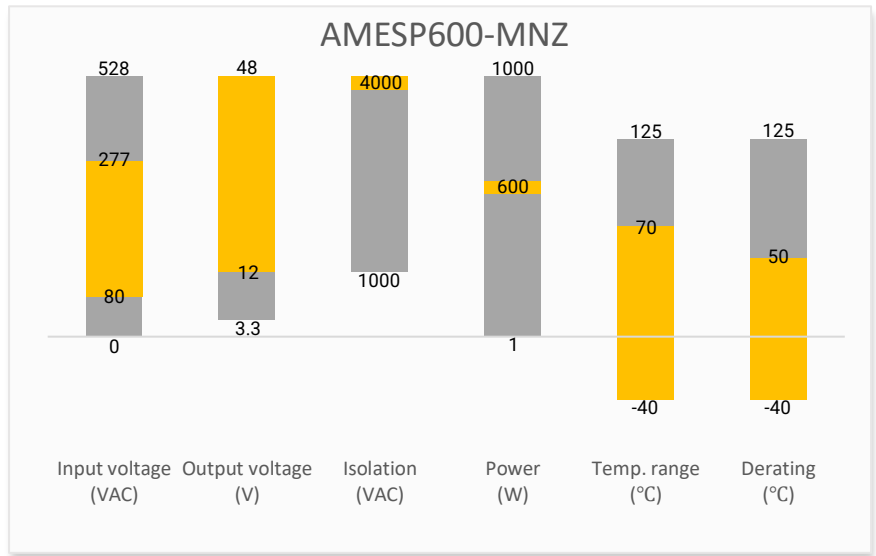

Training



Product Training Video
(click to open)

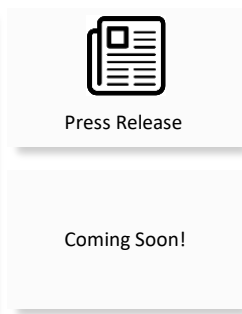

Application Notes

Applications



Power Grid



Industrial



Telecom



Instrumentation

Models & Specifications

Single Output								
Model	Input Voltage (VAC/Hz)	Input Voltage (VDC)	Max Output Wattle (W)	Output Voltage (V)	Output Voltage Adjustable Range (V)	Output Current max (A)	Maximum capacitive load (μ F)	Efficiency @230VAC (%)
AMESP600-12SMNZ	80-277/47-63	110-390	600	12	11.8-12.6	50	6000	92
AMESP600-15SMNZ	80-277/47-63	110-390	600	15	14.7-15.8	40	6000	92
AMESP600-24SMNZ	80-277/47-63	110-390	600	24	23.5-25.2	25	4000	94
AMESP600-27SMNZ	80-277/47-63	110-390	600	27	26.4-28.4	22.3	4000	94
AMESP600-36SMNZ	80-277/47-63	110-390	600	36	35.3-37.8	16.7	2400	94
AMESP600-48SMNZ	80-277/47-63	110-390	600	48	47.0-50.4	12.6	1600	94

Input Specifications				
Parameters	Conditions	Typical	Maximum	Units
Input current	115VAC		7.5	A
	230VAC		3.5	A
Inrush current	230VAC, cold start	40		A
Power factor	115VAC, Full load	0.98		--
	230VAC, Full load	0.95		--
Leakage current	240VAC		0.1	mA

Output Specifications				
Parameters	Conditions	Typical	Maximum	Units
Voltage accuracy	Full load, main output	± 1		%
	Full load, 5V auxiliary standby power	± 2		%
Line regulation	Full load, main output	± 0.3		%
	Full load, 5V auxiliary standby power	± 0.5		%
Load regulation	Full load, main output	± 0.5		%
	Full load, 5V auxiliary standby power	± 2		%
Ripple & Noise*	12V/15V output	150		mV _{p-p}
	24V/27V output	200		mV _{p-p}
	36V/48V output	300		mV _{p-p}
Hold up time	230VAC	>15		ms
Minimum load		0		%
Auxiliary standby power		5		V
		1		A

* Ripple and Noise are measured at 20MHz bandwidth with a 47 μ F electrolytic capacitor and a 0.1 μ F ceramic capacitor. Please refer to the application note for specific details.

** Standby power: provide 5V/1A independent output, it is recommended to use with the main circuit.

Isolation Specifications				
Parameters	Conditions	Typical	Rated	Units
Tested I/O voltage	60 sec, leakage current < 5mA		4000	VAC
Tested I/O to GND voltage	60 sec, leakage current < 5mA		1500	VAC
Resistance (I/O, I/O to GND) *	500VDC		>50	MΩ

* Tested under 25±5°C ambient temperature with relative humidity <95% and no condensation.

General Specifications				
Parameters	Conditions	Typical	Maximum	Units
Over Current protection	Auto recovery	≥ 110	160	% of Iout
Over voltage protection	Re-power on for recovery, 12V output		16	VDC
	Re-power on for recovery, 15V output		20	VDC
	Re-power on for recovery, 24V output		32	VDC
	Re-power on for recovery, 27V output		35	VDC
	Re-power on for recovery, 36V output		47	VDC
	Re-power on for recovery, 48V output		60	VDC
Over temperature protection*	Output voltage turn off, Auto recover after temperature drops			
Short circuit protection	Hiccup, Auto recovery after the short circuit disappear, Recover time < 3s			
No-load power consumption	230VAC, ON/OFF add +5V signal	0.5		W
Operating temperature	See derating graph	-40 to +70		°C
Storage temperature		-40 to +85		°C
Power derating	50 °C to 70 °C	2.5		% / °C
	80VAC ~ 85VAC	2.0		% / VAC
	85VAC ~ 100VAC	1.33		% / VAC
Cooling	Forced air cooling			
Humidity	Non-condensing, Storage	≥ 10	95	% RH
	Non-condensing, Operating	≥ 20	90	% RH
Case material	Metal (1100 Aluminum, SGCC)			
Weight		1000		g
Dimensions (L x W x H)	4.00 x 8.00 x 1.60 inch (101.6 x 203.1 x 40.6mm)			
MTBF	> 300 000 hrs (MIL-HDBK -217F, t=+25°C)			

*Tested under full-load condition.
NOTE: All specifications in this datasheet are measured at an ambient temperature of 25°C, humidity<75%, nominal input voltage and at rated output load unless otherwise specified.

Safety Specifications		
Parameters		
Agency approvals	EN/BS EN 62368-1	
Standards	Information technology Equipment	Design to meet IEC/UL 62368-1, EN 61558-2-16, EN 61558-1, EN 60335-1, GB4943.1, IEC/EN 60601-1
	EMC - Conducted and radiated emission	CISPR32 / EN55032, class B
	Harmonic current	IEC 61000-3-2, class A and class D
	Voltage flicker	IEC 61000-3-3
	Electrostatic Discharge Immunity	IEC 61000-4-2 Contact ±8KV / Air ±15KV, Criteria A
	RF, Electromagnetic Field Immunity	IEC 61000-4-3 10V/m, Criteria A
	Electrical Fast Transient/Burst Immunity	IEC 61000-4-4 ±4KV, Criteria A
	Surge Immunity	IEC 61000-4-5 L-L ±2KV/L-G ±4KV, Criteria A
	RF, Conducted Disturbance Immunity	IEC 61000-4-6 10Vr.m.s, Criteria A
	Voltage dips, Short Interruptions Immunity	IEC 61000-4-11 0%, 70%, Criteria B

Derating



Forced Air Convection

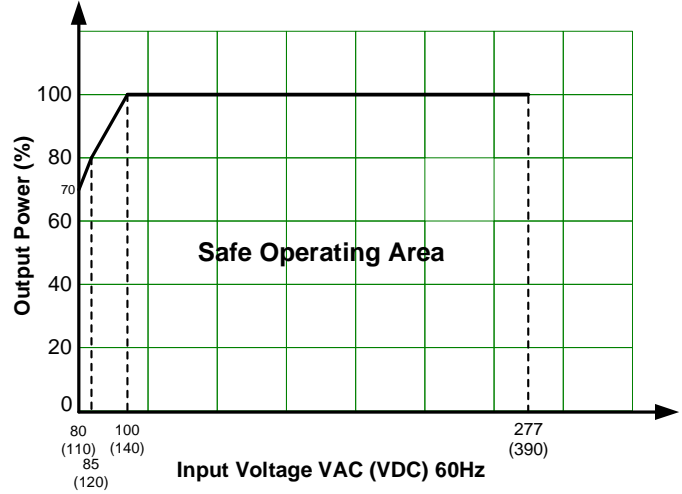
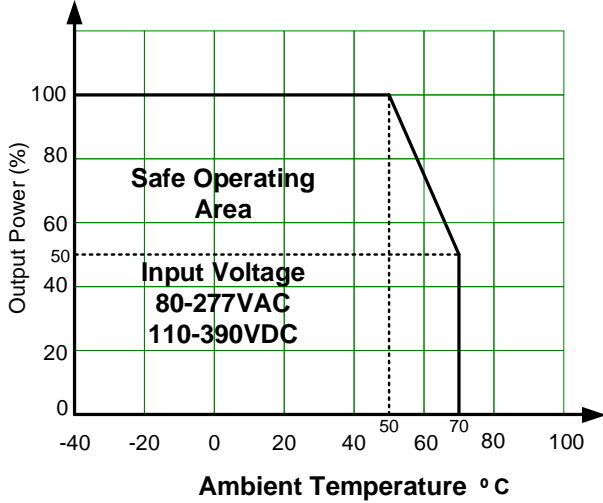

Note: In addition to the temperature derating, input voltage derating must be applied when the input voltage is between 80-100VAC and 110-140VDC.

Remote ON/OFF

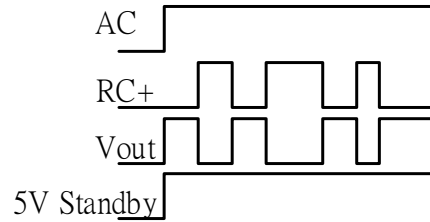
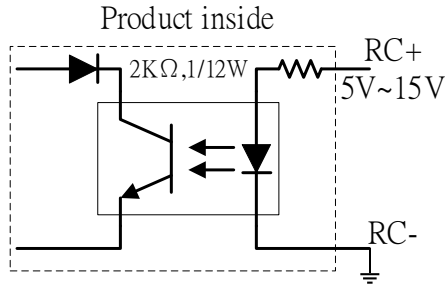

Note:

1. When the product is working normally, apply voltage (5V~15V) to RC+ and RC- to trigger the remote ON/OFF function, and the output voltage will be off. Withdraw the voltage, the output voltage will be re-established.
2. 5V auxiliary standby power supply is not controlled by remote ON/OFF function.

DC-OK

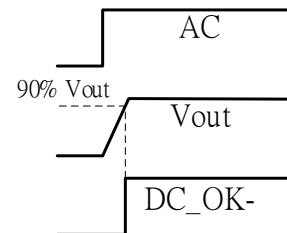
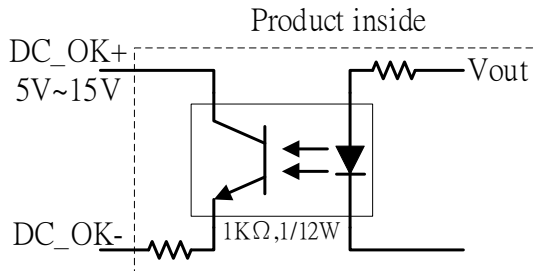

- Note:
1. When the output voltage (5V~15V) of the product reaches 90% of the rated value, DC_OK+ will be connected to DC_OK-.
 2. It is recommended the users apply a certain voltage between DC_OK+ and DC_OK- to detect the signal.

Remote Sense Compensation

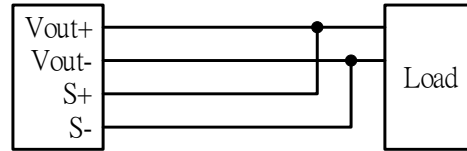

- Note:
1. The left side represents the internal schematic diagram of the product, the right side represents the customer system.
 2. Twisted pair wires are needed for S+/S-.

Dimensions

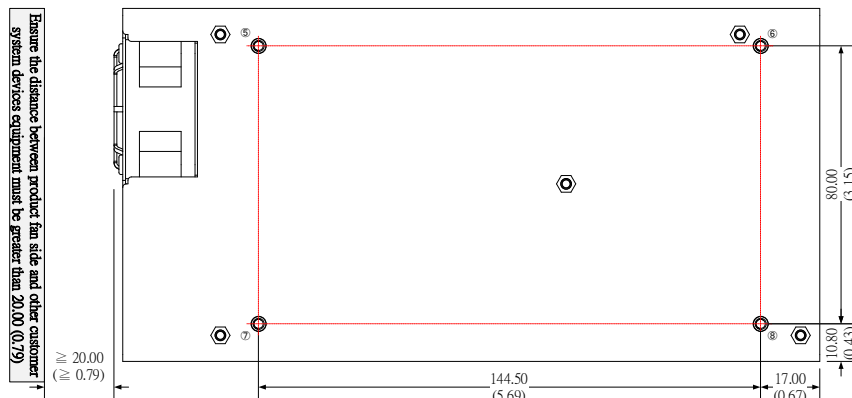
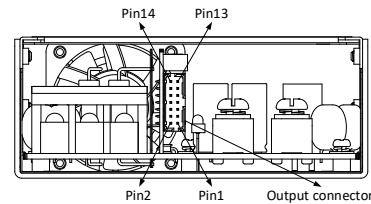
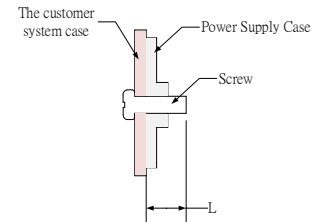
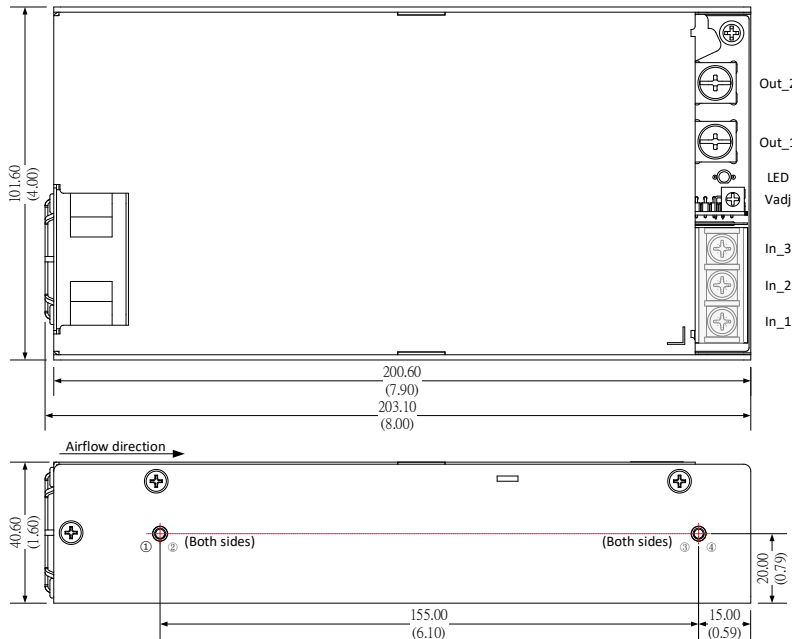

- Note:
- Unit: mm(inch)
 - Input wire gauge: 22-14AWG
 - Input screw terminal tightening torque: M4, 1.2N-m(Max)
 - Output screw terminal tightening torque: M5, 2.4N-m(Max)
 - Mounting screw tightening torque: M3, 4mm(Max), 0.4N-m(Max)
 - General tolerance: $\pm 1.0(\pm 0.04)$
 - At least one of the ① - ⑧ location must be connected to PE

Pin Output Specifications	
Pin	Function
In_1	GND
In_2	AC Input (L)
In_3	AC Input (N)
Out_1	+V Output
Out_2	-V Output

Pin Output Specifications				
Pin	Function	Pin	Function	Recommended connector
1	S(-)	8	5V _{SB} (-)	MOLEX, 51110-1450(Without locking ramp) or MOLEX, 51110-1451(With locking ramp) or equivalent
2	S(+)	9	RC(+)	
3	--	10	RC(-)	
4	--	11	5V _{SB} (+)	
5	DC_ok(-)	12	5V _{SB} (+)	
6	DC_ok(+)	13	5V _{SB} (-)	
7	5V _{SB} (+)	14	5V _{SB} (-)	

Note:

1. All the measured parameters in this datasheet were under the conditions of Ta=25°C, humidity < 75% RH with nominal input voltage and rated output load.
2. The temperature derate of 5°C/1000m is required while operating altitude greater than 2000m.
3. All the testing methods of the index data that are shown in this datasheet are based on our company's corporate standards.
4. There might have a presence of audible noise due to the trade-off of the efficiency at high-LINE input voltage. However, it doesn't affect the power supply's performance and reliability.
5. The power supply case must be connected to the system's Protective Earth(PE) when the terminal equipment is in operation.
6. The potentiometer ADJ next to the output screw terminal is used to adjust the output voltage. Turning clockwise to increase the voltage and counter-clockwise to decrease the output voltage.

NOTE: **1.** Datasheets are updated as needed and as such, specifications are subject to change without notice. Once printed or downloaded, datasheets are no longer controlled by Aimtec; refer to www.aimtec.com for the most current product specifications. **2.** Product labels shown, including safety agency certifications on labels, may vary based on the date manufactured. **3.** Mechanical drawings and specifications are for reference only. **4.** All specifications are measured at an ambient temperature of 25°C, humidity<75%, nominal input voltage and at rated output load unless otherwise specified. **5.** Aimtec may not have conducted destructive testing or chemical analysis on all internal components and chemicals at the time of publishing this document. CAS numbers and other limited information are considered proprietary and may not be available for release. **6.** This product is not designed for use in critical life support systems, equipment used in hazardous environments, nuclear control systems or other such applications which necessitate specific safety and regulatory standards other the ones listed in this datasheet. **7.** Warranty is in accordance with Aimtec's standard Terms of Sale available at www.aimtec.com.