

Data sheet | Item number: 2070-521/998-406

Through-Board SMD PCB Terminal Block; 0.75 mm²; Pin spacing 6.5 mm; 1-pole; Push-in CAGE CLAMP®; in tape-and-reel packaging; 0,75 mm²; white

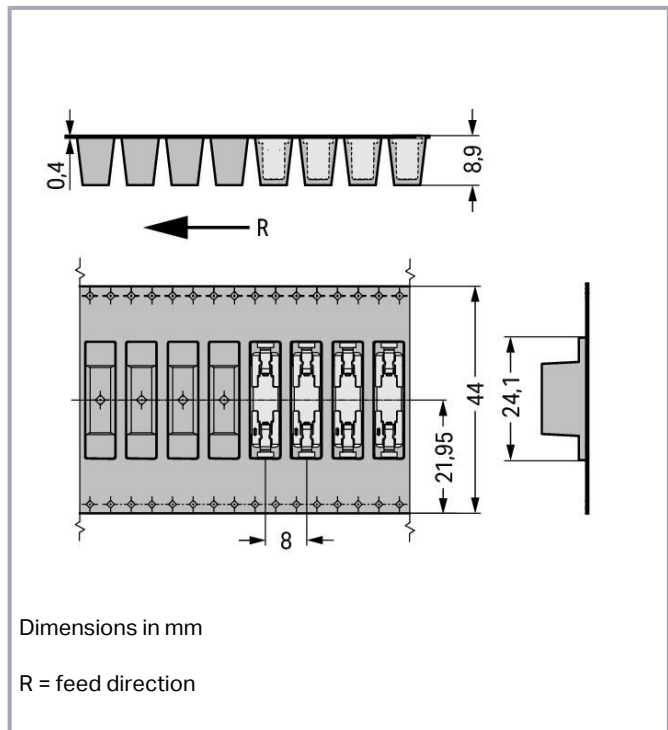

www.wago.com/2070-521/998-406

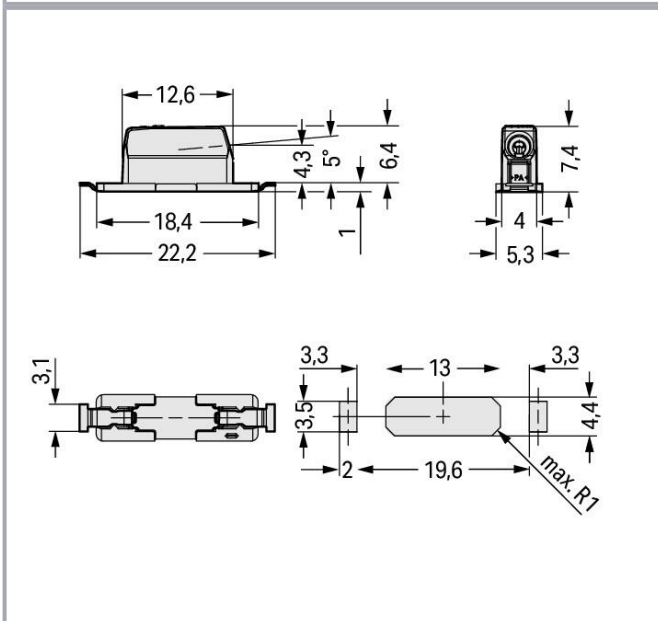
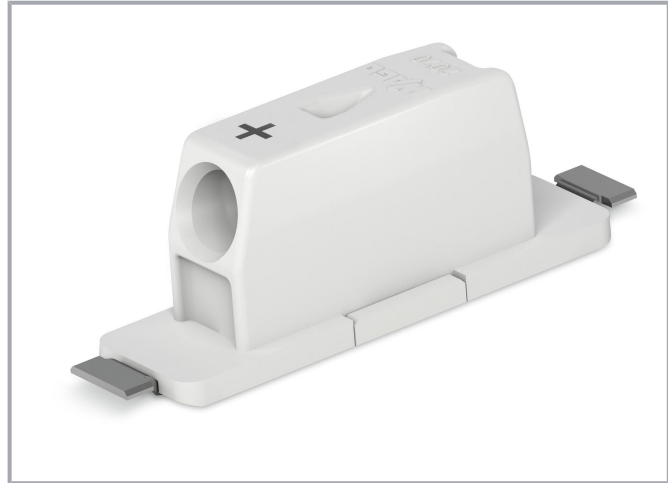

Subject to changes. Please also observe the further product documentation!

WAGO GmbH & Co. KG
Hansastr. 27
32423 Minden
Phone: +49571 887-0 | Fax: +49571 887-169
Email: info.de@wago.com | Web: www.wago.com

Do you have any questions about our products?
We are always happy to take your call at +49 (571) 887-44222.



Item description

- SMD PCB terminal block with Push-in CAGE CLAMP® for back-side wiring of LED modules
- Low profile of just 1.1 mm on the module's front side
- Push-in termination of solid conductors
- Insert fine-stranded conductors and remove all conductors via operating tool

Data

Notes

Note	Depending on reflow soldering temperatures and times, color deviations may occur. These deviations will have no impact on functionality.
------	--

Variants:	Reel diameter of tape-and-reel packaging: 381 mm Other versions (or variants) can be requested from WAGO Sales or configured at https://configurator.wago.com/ .
-----------	--

Electrical data

Ratings per IEC/EN

Ratings per	IEC/EN 60664-1
Ratings for	Electrical data for FR4 PCB type
Nominal voltage (III/3)	320 V
Rated impulse voltage (III/3)	4 kV
Rated voltage (III/2)	320 V
Rated impulse voltage (III/2)	4 kV
Nominal voltage (II/2)	630 V
Rated surge voltage (II/2)	4 kV
Rated current	9 A
Legend (ratings)	(III / 2) ≙ Overvoltage category III / Pollution degree 2

Ratings per IEC/EN 2

Ratings per 2	IEC/EN 60664-1
Ratings for	Electrical data for metal-core PCBs
Rated voltage (III/3) 2	200 V
Rated surge voltage (III/3) 2	4 kV
Rated voltage (III/2) 2	320 V

Subject to changes. Please also observe the further product documentation!

WAGO GmbH & Co. KG
Hansastr. 27
32423 Minden
Phone: +49571 887-0 | Fax: +49571 887-169
Email: info.de@wago.com | Web: www.wago.com

Do you have any questions about our products?
We are always happy to take your call at +49 (571) 887-44222.



Rated surge voltage (III/2) 2	4 kV
Rated voltage (II/2) 2	500 V
Rated surge voltage (II/2) 2	4 kV
Rated current 2	9 A

Ratings per UL 1977

Rated voltage (UL 1977)	600 V
Rated current UL 1977	9 A

Connection data

Connection points	1
Total number of potentials	1
Number of connection types	1
Number of levels	1

Connection 1

Connection technology	Push-in CAGE CLAMP®
Actuation type	Operating tool
Solid conductor	0.2 ... 0.75 mm ² / 24 ... 18 AWG
Fine-stranded conductor	0.2 ... 0.75 mm ² / 24 ... 18 AWG
Strip length	8 ... 10 mm / 0.31 ... 0.39 inches
Conductor connection direction to PCB	0°
Pole number	1

Physical data

Pin spacing	6.5 mm / 0.256 inches
Width	5.3 mm / 0.209 inches
Height	7.45 mm / 0.293 inches
Depth	22.2 mm / 0.874 inches
Reel diameter of tape-and-reel packaging	330 mm
Tape width	44 mm
PCB thickness (max.)	2.4 mm

Mechanical Data

Marking	+
Design	with Cover

Subject to changes. Please also observe the further product documentation!

WAGO GmbH & Co. KG
 Hansastr. 27
 32423 Minden
 Phone: +49571 887-0 | Fax: +49571 887-169
 Email: info.de@wago.com | Web: www.wago.com

Do you have any questions about our products?
 We are always happy to take your call at +49 (571) 887-44222.



Mounting type	Through-board
---------------	---------------

PCB contact

PCB contact	SMD
Solder pin arrangement	Over the entire terminal strip (in-line)
Number of solder pins per potential	2

Material Data

Note (material data)	Information on material specifications can be found here
----------------------	--

Color	white
Material group	I
Insulation material	Polyphthalamide (PPA GF)
Flammability class per UL94	V0
Contact material	Copper alloy
Contact plating	Tin
Fire load	0.011 MJ
Weight	0.6 g

Environmental requirements

Limit temperature range	-60 ... +105 °C
-------------------------	-----------------

Commercial data

eCl@ss 10.0	27-14-11-06
eCl@ss 9.0	27-14-11-06
ETIM 8.0	EC001284
ETIM 7.0	EC001284
PU (SPU)	4770 (954) pcs
Packaging type	box
Country of origin	CH
GTIN	4055143645140
Customs tariff number	85369010000



Environmental Product Compliance

RoHS Compliance Status	Compliant, No Exemption
------------------------	-------------------------



Subject to changes. Please also observe the further product documentation!

Approvals / Certificates

General approvals

Logo	Approval	Additional Approval Text	Certificate name
	CB DEKRA Certification B.V.	IEC 60998	NL-57652
	CB DEKRA Certification B.V.	EN 60998	NL-57653
	KEMA/KEUR DEKRA Certification B.V.	EN 60947-7-4	71- 107965
	KEMA/KEUR DEKRA Certification B.V.	EN 60998	71- 107967
	UR Underwriters Laboratories Inc.	UL 1977	E45171

Declarations of conformity and manufacturer's declarations

Logo	Approval	Additional Approval Text	Certificate name
	EU-Declaration of Conformity WAGO GmbH & Co. KG	-	-
	UK-Declaration of Conformity WAGO GmbH & Co. KG	-	-

Optional accessories

Tool

Operating tool		
	Item no.: 2070-400 Operating tool; made of insulating material; green	www.wago.com/2070-400

Subject to changes. Please also observe the further product documentation!



Downloads

Documentation

Additional Information

Technical Section	2019 Apr 3	pdf	Download
Technical explanations		2.0 MB	

CAD/CAE-Data

CAD data

2D/3D Models 2070-521/998-406	URL	Download
-------------------------------	-----	----------

PCB Design

Symbol and Footprint 2070-521/998-406	URL	Download
---------------------------------------	-----	----------

CAX data for your PCB design, consisting of "schematic symbols and PCB footprints", allow easy integration of the WAGO component into your development environment.

Supported formats:

- Accel EDA 14 & 15
- Altium 6 to current version
- Cadence Allegro
- DesignSpark
- Eagle Libraries
- KiCad
- Mentor Graphics BoardStation
- Mentor Graphics Design Architect
- Mentor Graphics Design Expedition 99 and 2000
- OrCAD 9.X PCB and Capture
- PADS PowerPCB 3, 3.5, 4.X, and 5.X
- PADS PowerPCB and PowerLogic 3.0
- PCAD 2000, 2001, 2002, 2004, and 2006
- Pulsonix 8.5 or newer
- STL
- 3D STEP
- TARGET 3001!
- View Logic ViewDraw

—
Subject to changes. Please also observe the further product documentation!

- Quadcept
- Zuken CadStar 3 and 4
- Zuken CR-5000 and CR-8000

PCB Component Libraries (EDA), PCB CAD Library Ultra Librarian

CAE data

	URL	Download
ZUKEN Portal 2070-521/998-406		

Environmental Product Compliance

Compliance Search

	URL	Download
Environmental Product Compliance 2070-521/998-406		
Through-Board SMD PCB Terminal Block; 0.75 mm ² ; Pin spacing 6.5 mm; 1-pole; Push-in CAGE CLAMP®; in tape-and-reel packaging; 0,75 mm ² ; white		

Installation Notes

Conductor termination

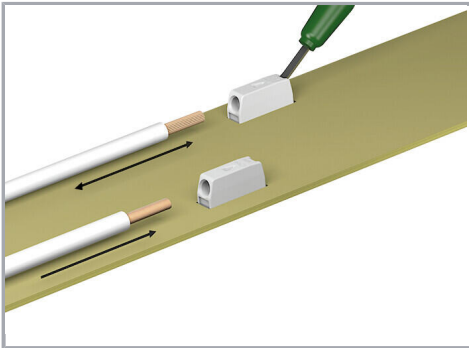

Insert fine-stranded conductors and remove all conductor types via operating tool. Solid conductors can also be terminated by simply pushing them in.

Conductor removal

Subject to changes. Please also observe the further product documentation!

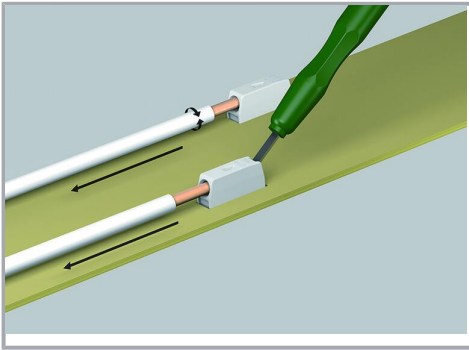

Use an operating tool or simply "twist and pull" to remove solid conductors.

Installation

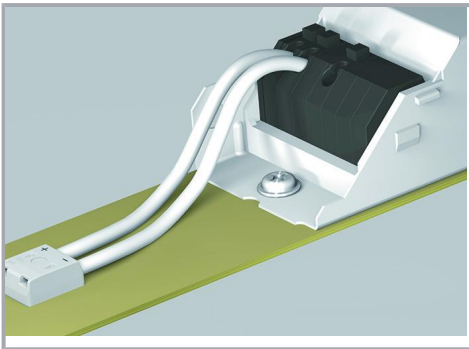

Shift wiring to the back of the LED module via 2070 Series SMD PCB Terminal Blocks.

Application

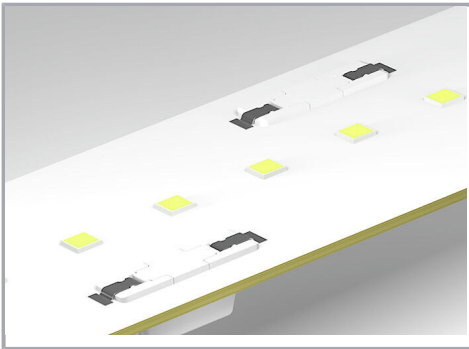

The variants with cover feature a center contact surface for easy pick-and-place assembly and minimum shadowing.

Subject to changes. Please also observe the further product documentation!

Application

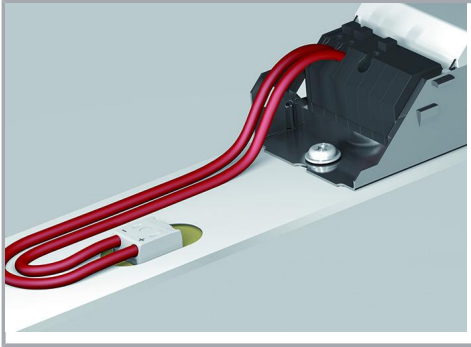

The printed variants offer unique pole marking on the back of the module.

Subject to changes. Please also observe the further product documentation!