

LOC	DIST	REVISIONS AENDERUNGEN					
		P	LTR	DESCRIPTION BESCHREIBUNG	DATE	DWN	APVD
AI	-						
PROJEKT NR.: EGLPC00034			B6	NEW LABEL-VERSION -5 ADDED, UL LISTING ADJUSTED	04MAR2011	VP	AW
			C1	NOTE 1 (MATERIAL) REWORKED PER PCN E-11-010718	27MAY2011	ER	BW
			D1	MATERIAL OF INSTANCE -2 IS CHANGED	02NOV2012	KR	T.J
			D2	ECR-17-011826	08FEB2018	FF	MS

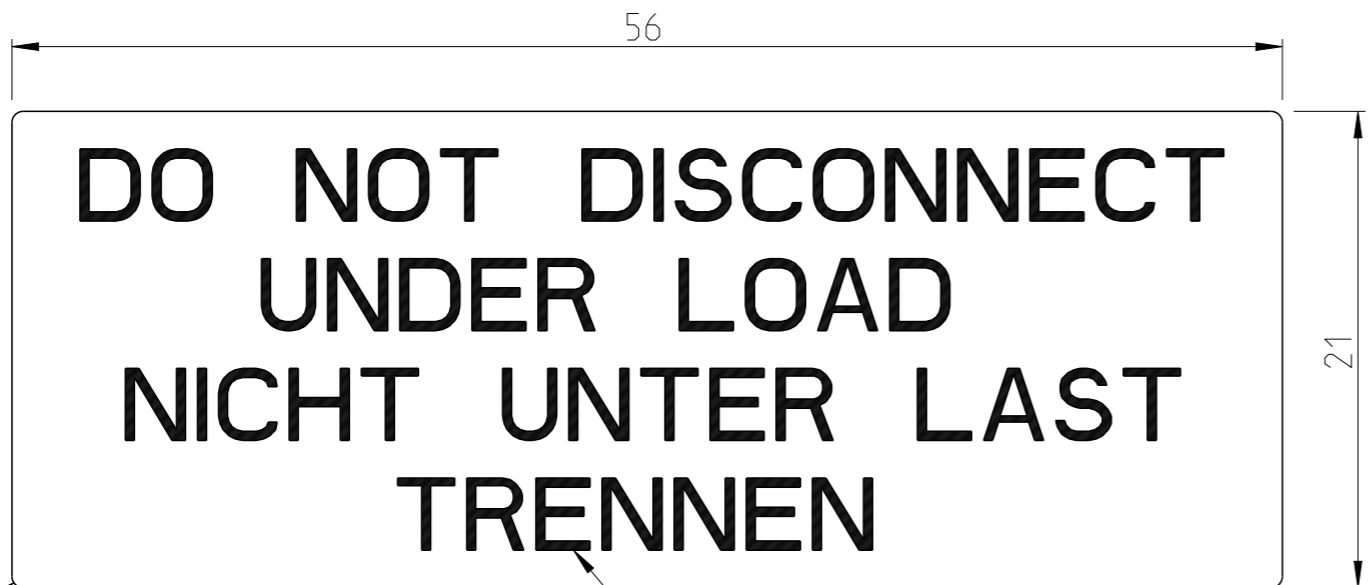

R0.5 (4x)
 -1 / -2 / -3 AS SHOWN
 -1 / -2 / -3 WIE GEZEICHNET

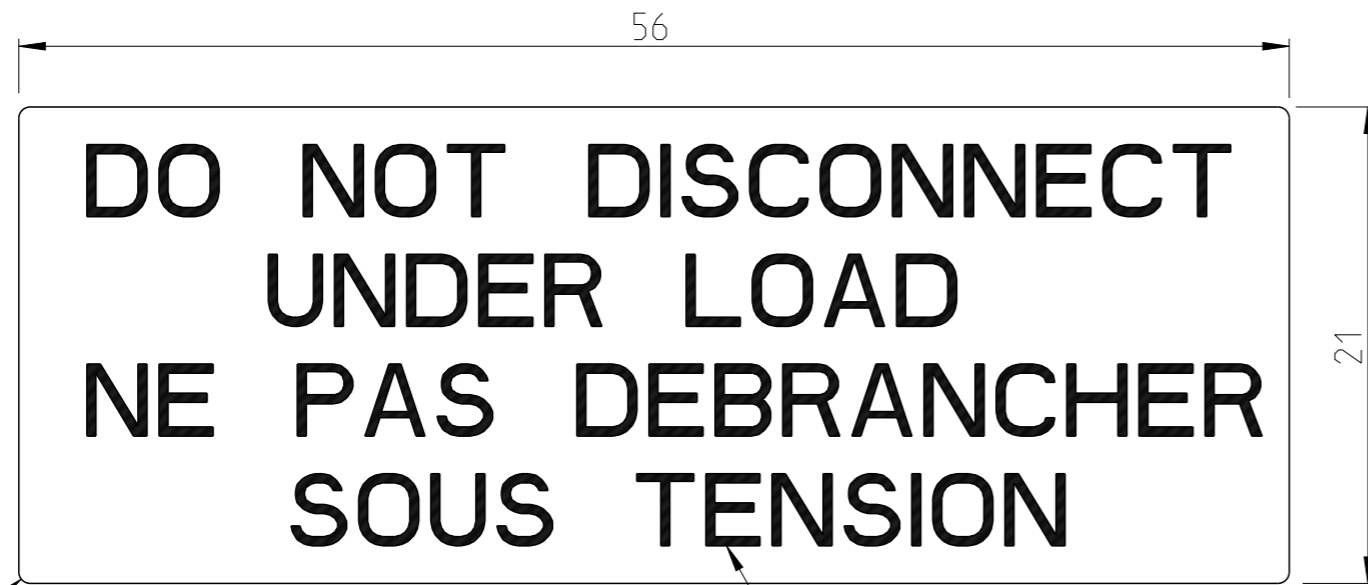

R0.5 (4x)
 -4 AS SHOWN
 -4 WIE GEZEICHNET

- 1 MATERIAL: POLYESTER, UL LISTED PER PGDQ2, SUITABLE FOR OUTDOOR USE WHEN AFFIXED TO NYLON OR POLYCARBONATE.
- 2 CHARACTER COLOUR BLACK
- 3 LABEL COLOUR WHITE
- 4 REAR SIDE SELF ADHESIVE
- 5 PACKAGING SEE TABLE

- 1 MATERIAL: POLYESTER, UL GELISTET NACH PGDQ2, FUER AUSSENNUTZUNG GEEIGNET WENN AUF NYLON ODER POLYCARBONAT BEFESTIGT.
- 2 SCHRIFTFARBE SCHWARZ
- 3 ETIKETTFARBE WEISS
- 4 RUECKSEITE SELBSTKLEBEND
- 5 VERPACKUNG SIEHE TABELLE

5.000 LABEL	ON REEL	-5
5.000 LABEL	ON REEL	-4
5.000 LABEL	ON REEL	-3
100 LABEL	10 LABEL PER SHEET 10 SHEETS IN A BAG	-2
10.000 LABEL	ON REEL	-1
QUANTITY	FORM	PART NO.
5 PACKAGING		

D2

THIS DRAWING IS A CONTROLLED DOCUMENT.

DIMENSIONS: MASSEINHEITEN: MM	TOLERANCES UNLESS OTHERWISE SPECIFIED: ALLGEMEINTOLERANZEN
	0 PLC ±1 1 PLC ± 2 PLC ± 3 PLC ± 4 PLC ± ANGLES/W INKEL ± FINISH/OBERFLAECHE/FARBE -
MATERIAL -	

DWN FRANK FAN 08FEB2018	TE Connectivity LABEL ETIKETT			
CHK ALEX ZHANG 08FEB2018				
APVD MING SHI 08FEB2018				
NAME				
PRODUCT SPEC PRODUKTSPEZ. -	SIZE A3	CAGE CODE 00779	DRAWING NO ZEICHNUNGS-NR. C-1718077	RESTRICTED TO NUR FUER -
APPLICATION SPEC VERARBEITUNGSSPEZ. -	SCALE MASSSTAB 3:1	SHEET BLATT 1	OF VON 2	REV D3
WEIGHT GEWICHT -	Customer Drawing /KUNDENZEICHNUNG			

LOC	DIST	P	LTR	DESCRIPTION BESCHREIBUNG	DATE	DWN	APVD
AI	-			SEE SHEET 1	-	-	-
PROJECT NR.: EGLPC00034							

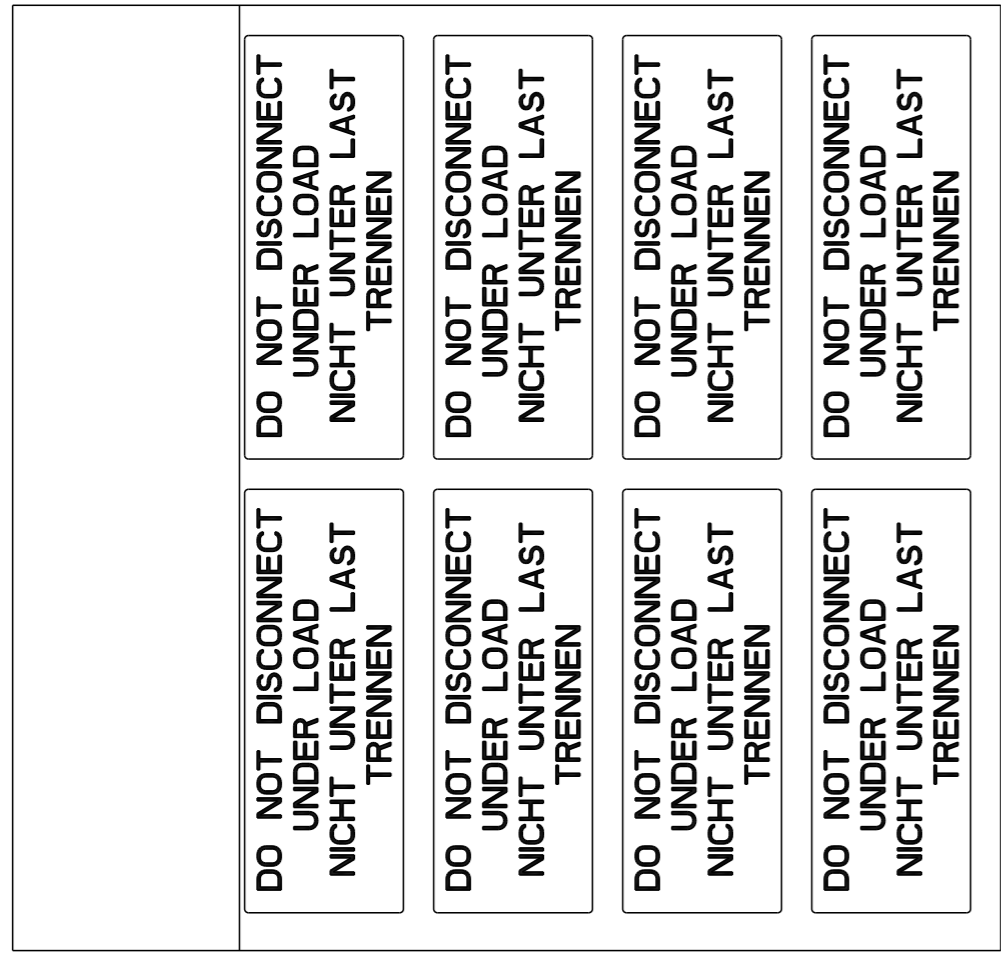

SCALE 1:1 / M 1:1

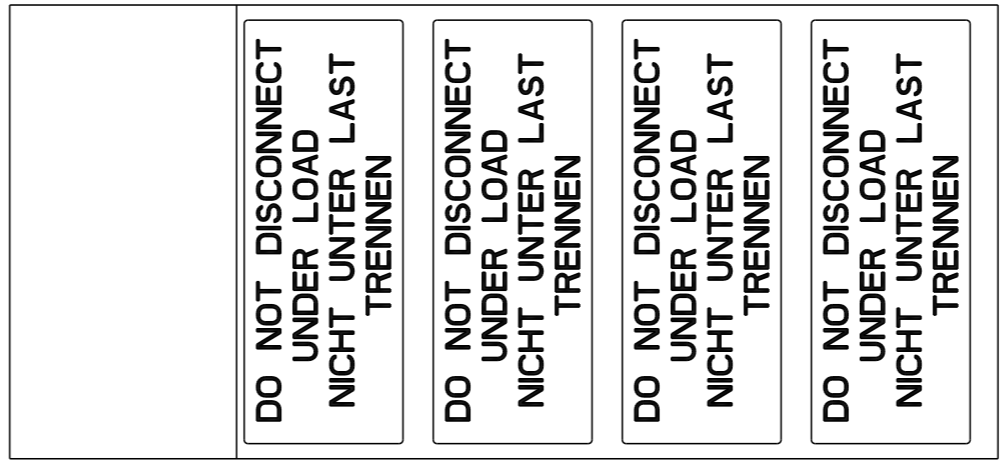

SCALE 1:1 / M 1:1

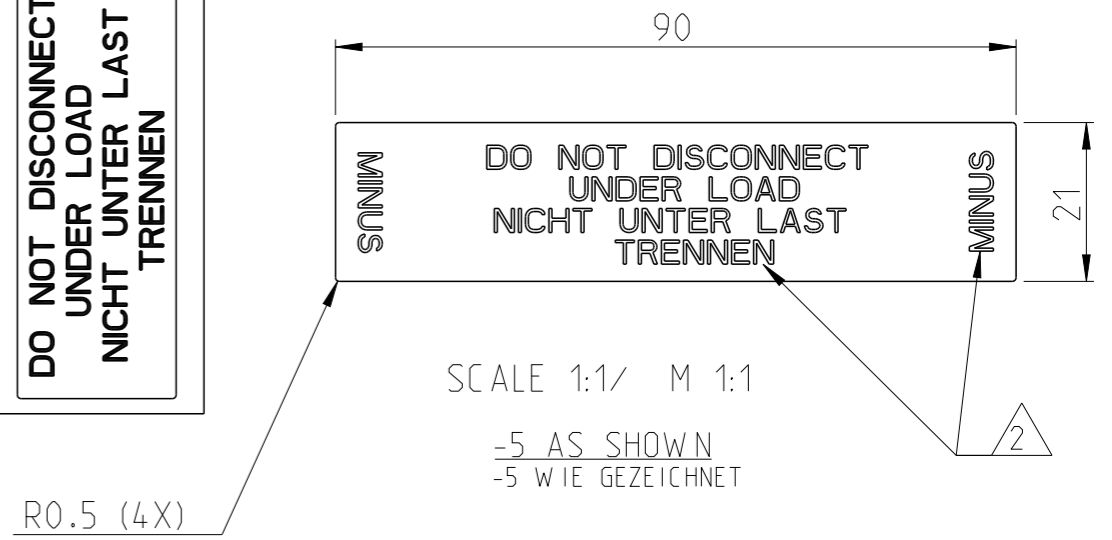

R0.5 (4X)

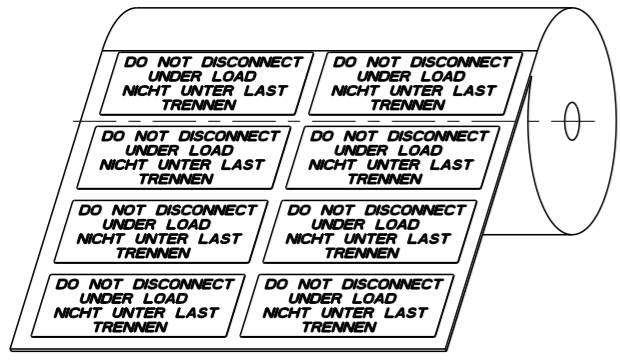

SCALE 1:2 / M 1:2

-1 AS SHOWN
-1 WIE GEZEICHNET

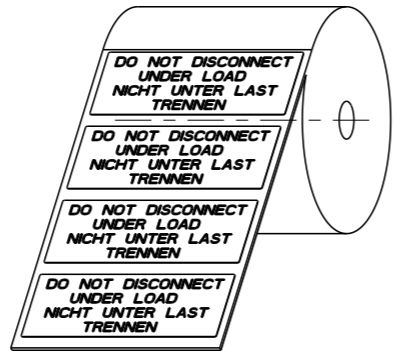

SCALE 1:2 / M 1:2

-3 AS SHOWN
-3 WIE GEZEICHNET

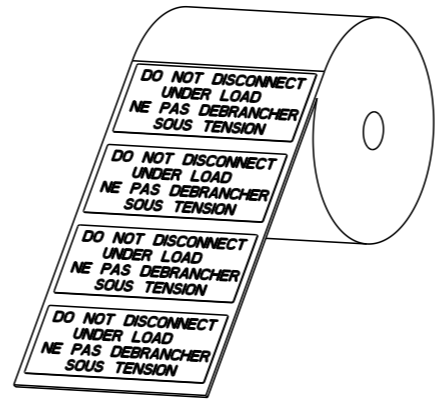

SCALE 1:2 / M 1:2

-4 AS SHOWN
-4 WIE GEZEICHNET

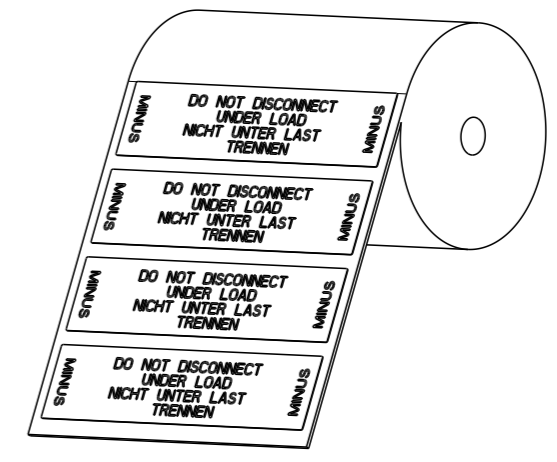

SCALE 1:2 / M 1:2

-5 AS SHOWN
-5 WIE GEZEICHNET

THIS DRAWING IS A CONTROLLED DOCUMENT.		DWN 08FEB2018 FRANK FAN			NAME LABEL ETIKETT		
DIMENSIONS: MASSEINHEITEN: mm		CHK 08FEB2018 ALEX ZHANG					
TOLERANCES UNLESS OTHERWISE SPECIFIED: ALLGEMEINTOLERANZEN		APVD 08FEB2018 MING SHI					
		PRODUCT SPEC PRODUKTSPEZ.	SIZE	CAGE CODE	DRAWING NO ZEICHNUNGS-NR.	RESTRICTED TO NUR FUER	
MATERIAL		APPLICATION SPEC VERARBEITUNGSSPEZ.	A3	00779	G=1718077	-	
FINISH/OBERFLAECHE/FARBE		WEIGHT GEWICHT	Customer Drawing		/KUNDENZEICHNUNG	SCALE MASSSTAB 3:1	SHEET BLATT 2 OF VON 2
				REV D3			