

DATA SHEET

SKY13309-370LF: PHEMT GaAs IC SP3T Switch 0.1–3.0 GHz

Features

- Positive low voltage control (0/3 V)
- Low insertion loss (0.5 dB at 2.5 GHz)
- High isolation (25 dB at 2.5 GHz)
- Excellent linearity performance ($P_{1\text{ dB}} = 29\text{ dBm}$)
- Miniature ultrathin MLP-8 pin plastic package (2 x 2 x 0.55 mm)
- Advanced PHEMT process
- Available lead (Pb)-free and RoHS-compliant MSL-1 @ 260 °C per JEDEC J-STD-020

Description

The SKY13309-370LF is a PHEMT GaAs IC SP3T antenna switch operating in the 0.1–3 GHz frequency range. Switching between the antenna and Tx/Rx ports is accomplished with 3 control voltages. The low loss, high isolation, high linearity, small size and low cost features make this switch ideal for all WLAN and Bluetooth® systems operating in the 2.4–2.5 GHz band.

Simplified Block Diagram

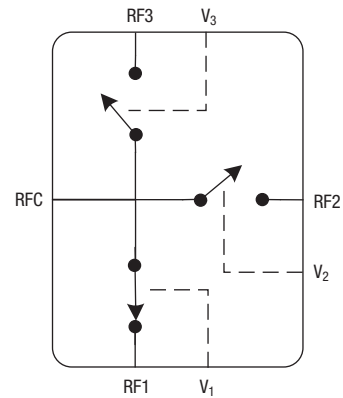

NEW Skyworks offers lead (Pb)-free, RoHS (Restriction of Hazardous Substances)-compliant packaging.



Electrical Specifications at 25 °C, $V_{\text{HIGH}} = 2.1\text{--}5\text{ V}$

Parameter	Condition	Frequency	Min.	Typ.	Max.	Unit
Insertion loss	RFC–RF1, RF2, RF3	0.1–3.0 GHz		0.6	0.75	dB
		2.4–2.5 GHz		0.5	0.65	dB
Return loss (Insertion loss state)	RFC–RF1, RF2, RF3	0.1–3.0 GHz		20		dB
		2.4–2.5 GHz		20		dB
Isolation	RFC–RF1, RF2, RF3	0.1–3.0 GHz	22	25		dB
		2.4–2.5 GHz	22	25		dB

Operating Characteristics at 25 °C

Parameter	Condition	Frequency	Min.	Typ.	Max.	Unit
Switching characteristics Rise/fall time On, off time	10/90% or 90/10% RF 50% CTL to 90/10% RF			30		ns
				25		ns
Video feedthru				40		mV
Input power for 1 dB compression	$V_{\text{LOW}} = 0\text{ V}$, $V_{\text{HIGH}} = 3.3\text{ V}$	2450 MHz		29		dBm
Input third order intermodulation intercept	For two-tone input power 17 dBm $V_{\text{LOW}} = 0\text{ V}$, $V_{\text{HIGH}} = 2.1\text{ V}$ $V_{\text{LOW}} = 0\text{ V}$, $V_{\text{HIGH}} = 3.3\text{ V}$	2450 MHz		37		dBm
		2450 MHz		45		dBm
Control voltages	$V_{\text{LOW}} = 0\text{ to }0.25\text{ V @ }5\text{ }\mu\text{A typ.}$ $V_{\text{HIGH}} = 2.1\text{ to }5.0\text{ V @ }10\text{ }\mu\text{A typ.}$			0		V
				3.3		V

Typical Performance Data at 25° C (0, 3.3 V)

RFC–RF1 State (Data Shown on 3 Units)

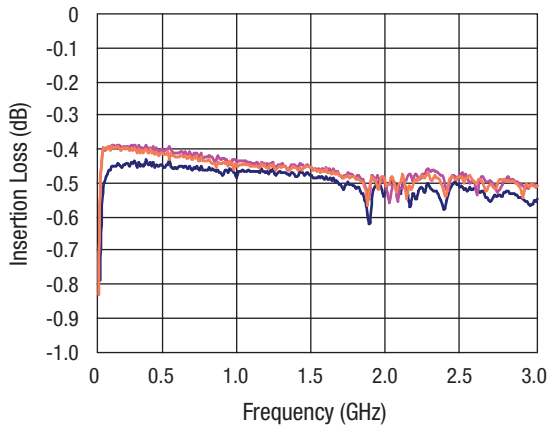

RFC to RF1 Insertion Loss

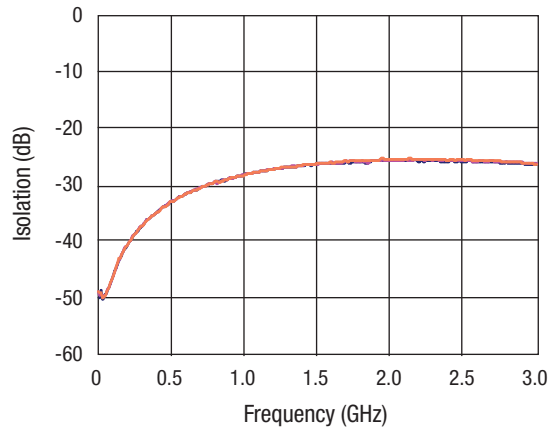

RFC to RF3 Isolation

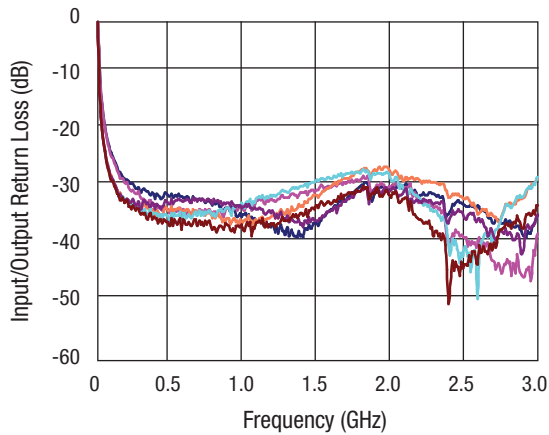

RFC to RF1 Return Loss

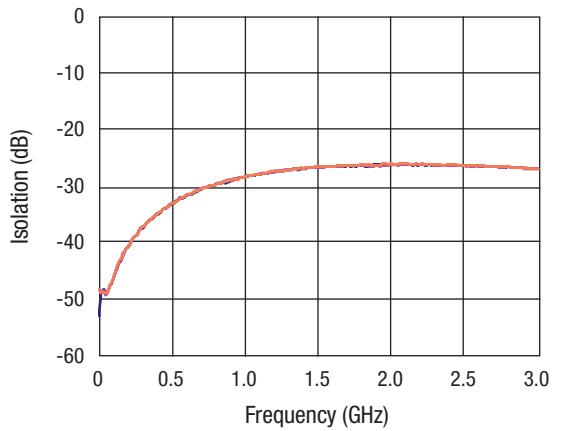

RFC to RF2 Isolation

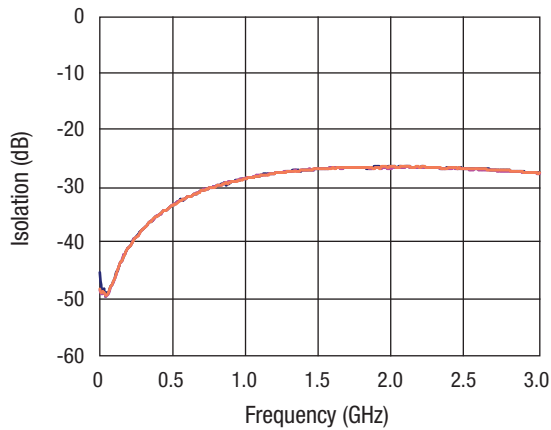

RF1 to RF2 Isolation

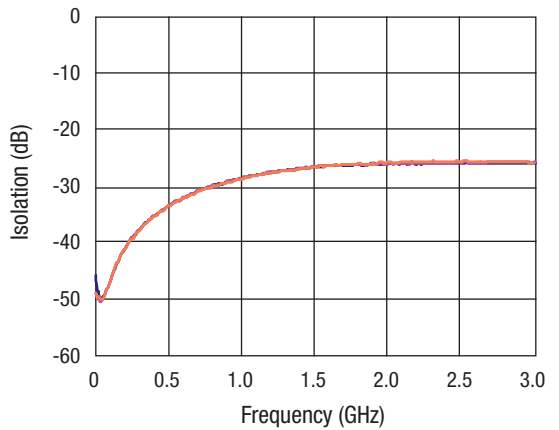

RF1 to RF3 Isolation

Typical Performance Data at 25° C (0, 3.3 V)

RFC–RF2 State (Data Shown on 3 Units)

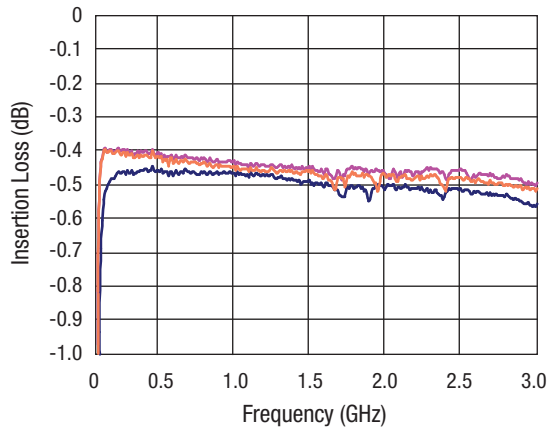

RFC to RF2 Insertion Loss

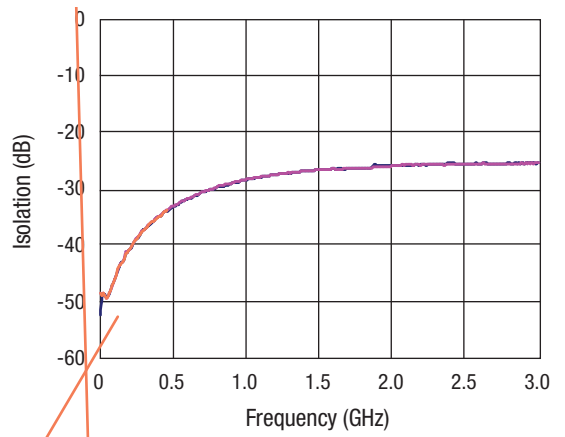

RFC to RF1 Isolation

Typical Performance Data at 25° C (0, 3.3 V)

RFC–RF3 State (Data Shown on 3 Units)

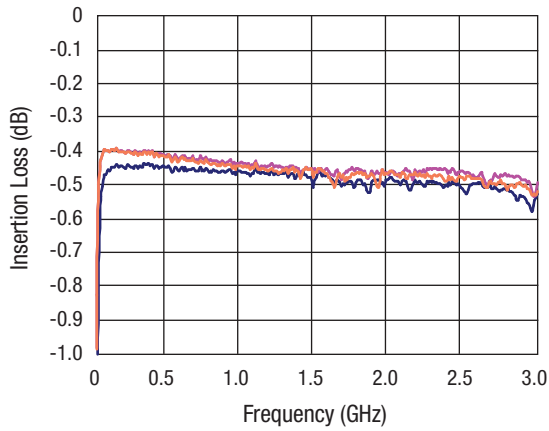

RFC to RF3 Insertion Loss

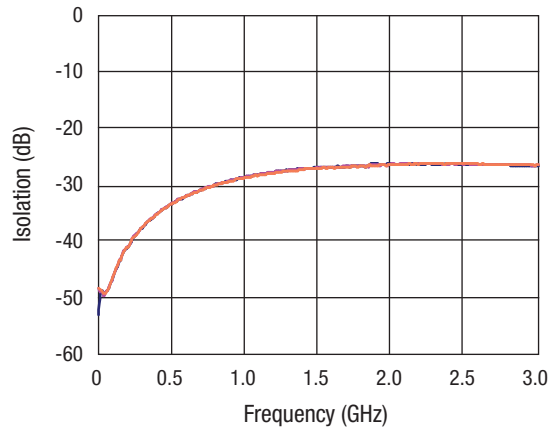

RFC to RF1 Isolation

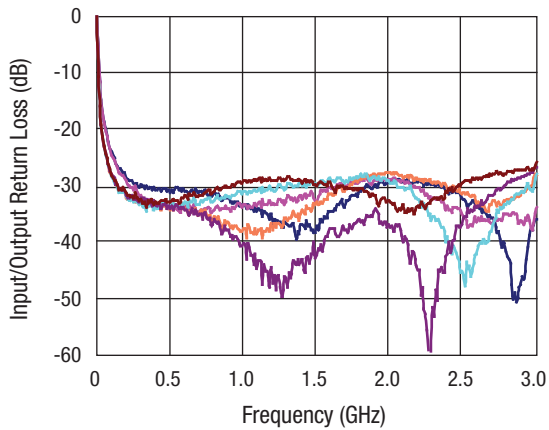

RFC to RF3 Return Loss

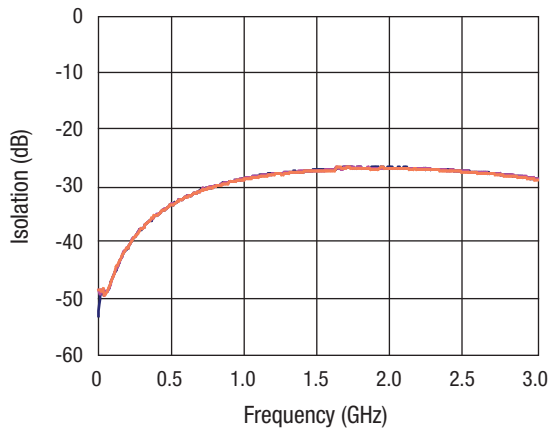

RFC to RF2 Isolation

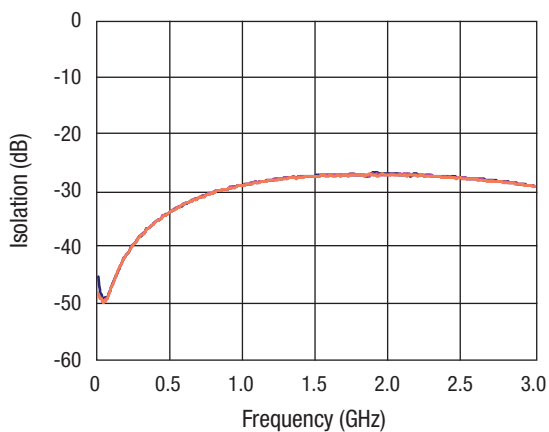

RF3 to RF1 Isolation

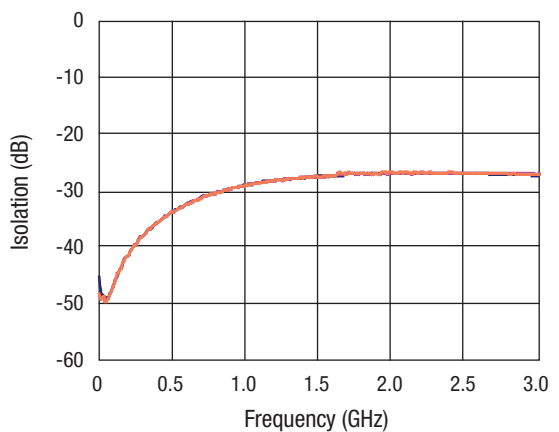

RF3 to RF2 Isolation

Truth Table

Low Insertion Loss Path	V ₁	V ₂	V ₃
RFC–RF1	High	Low	Low
RFC–RF2	Low	High	Low
RFC–RF3	Low	Low	High

High = 2.1 to 5 V.
 Low = 0 to 0.25 V.
 All other states not recommended. If a non-recommended state occurs, no damage to the switch will occur but it will be placed into an undefined state

Recommended Solder Reflow Profiles

Refer to the [“Recommended Solder Reflow Profile”](#) Application Note.

Tape and Reel Information

Refer to the [“Discrete Devices and IC Switch/Attenuators Tape and Reel Package Orientation”](#) Application Note.

Pin Out (Top View)

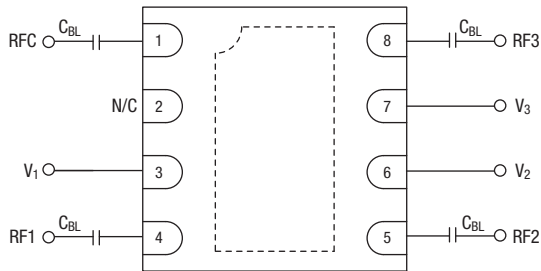

C_{BL} = 47 pF for operation > 500 MHz.
 C_{BL} = 220 pF for operation down to 50 MHz.
 Higher values recommended for lower frequency operation.
 Exposed paddle must be grounded.

Land Pattern

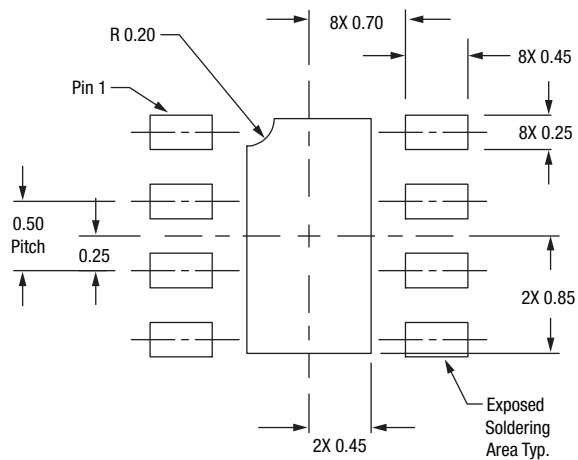

Absolute Maximum Ratings

Characteristic	Value
Max input power @ 0/3V	30 dBm
Max input power @ 0/5V	32 dBm
Operating voltage	+8.0 V
Operating temperature	-40 °C to +85 °C
Storage temperature	-65 °C to +150 °C

Performance is guaranteed only under the conditions listed in the specifications table and is not guaranteed under the full range(s) described by the Absolute Maximum specifications. Exceeding any of the absolute maximum/minimum specifications may result in permanent damage to the device and will void the warranty.

CAUTION: Although this device is designed to be as robust as possible, ESD (Electrostatic Discharge) can damage this device. This device must be protected at all times from ESD. Static charges may easily produce potentials of several kilovolts on the human body or equipment, which can discharge without detection. Industry-standard ESD precautions must be employed at all times.

-370

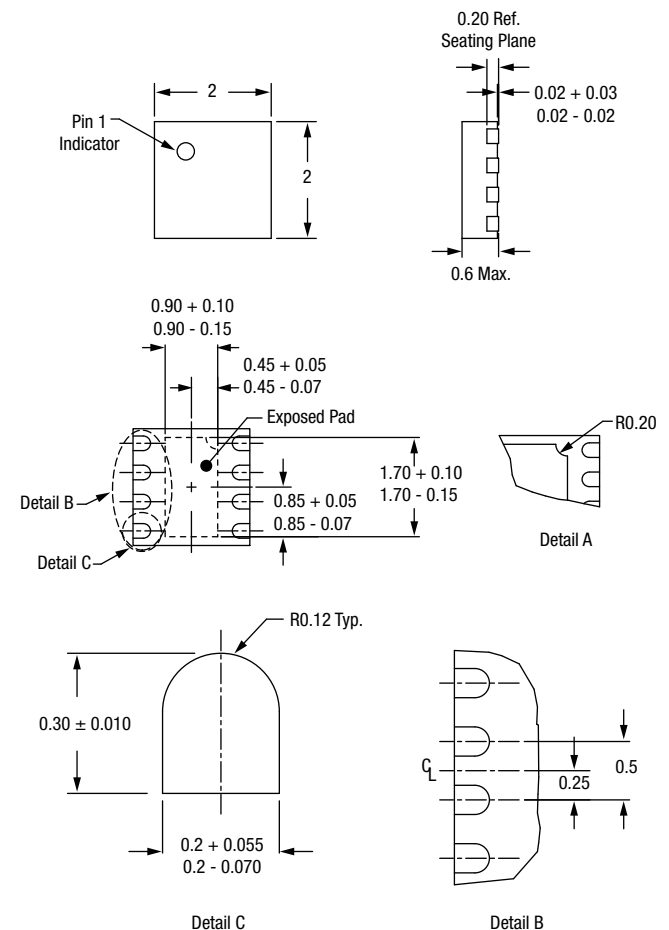

Part Marking

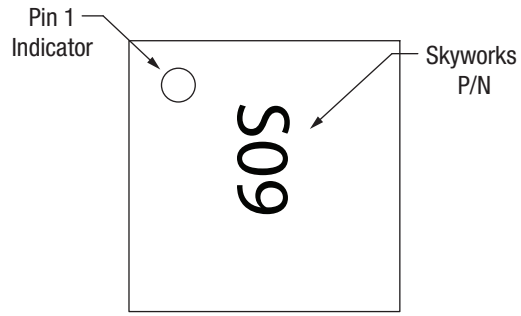

Evaluation Board

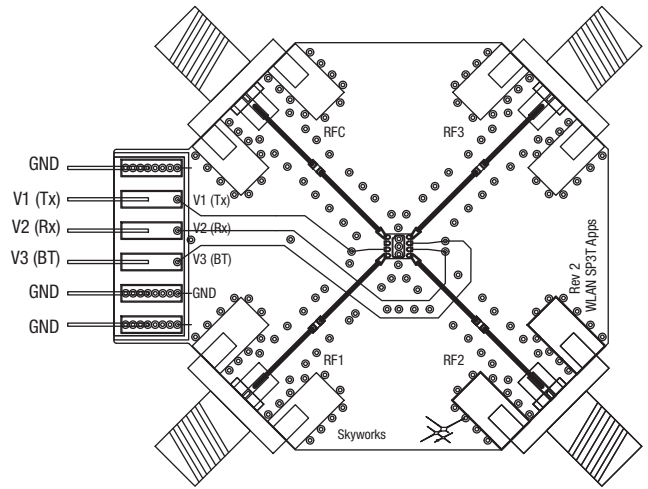

Copyright © 2007, 2008, Skyworks Solutions, Inc. All Rights Reserved.

Information in this document is provided in connection with Skyworks Solutions, Inc. ("Skyworks") products or services. These materials, including the information contained herein, are provided by Skyworks as a service to its customers and may be used for informational purposes only by the customer. Skyworks assumes no responsibility for errors or omissions in these materials or the information contained herein. Skyworks may change its documentation, products, services, specifications or product descriptions at any time, without notice. Skyworks makes no commitment to update the materials or information and shall have no responsibility whatsoever for conflicts, incompatibilities, or other difficulties arising from any future changes.

No license, whether express, implied, by estoppel or otherwise, is granted to any intellectual property rights by this document. Skyworks assumes no liability for any materials, products or information provided hereunder, including the sale, distribution, reproduction or use of Skyworks products, information or materials, except as may be provided in Skyworks Terms and Conditions of Sale.

THE MATERIALS, PRODUCTS AND INFORMATION ARE PROVIDED "AS IS" WITHOUT WARRANTY OF ANY KIND, WHETHER EXPRESS, IMPLIED, STATUTORY, OR OTHERWISE, INCLUDING FITNESS FOR A PARTICULAR PURPOSE OR USE, MERCHANTABILITY, PERFORMANCE, QUALITY OR NON-INFRINGEMENT OF ANY INTELLECTUAL PROPERTY RIGHT; ALL SUCH WARRANTIES ARE HEREBY EXPRESSLY DISCLAIMED. SKYWORKS DOES NOT WARRANT THE ACCURACY OR COMPLETENESS OF THE INFORMATION, TEXT, GRAPHICS OR OTHER ITEMS CONTAINED WITHIN THESE MATERIALS. SKYWORKS SHALL NOT BE LIABLE FOR ANY DAMAGES, INCLUDING BUT NOT LIMITED TO ANY SPECIAL, INDIRECT, INCIDENTAL, STATUTORY, OR CONSEQUENTIAL DAMAGES, INCLUDING WITHOUT LIMITATION, LOST REVENUES OR LOST PROFITS THAT MAY RESULT FROM THE USE OF THE MATERIALS OR INFORMATION, WHETHER OR NOT THE RECIPIENT OF MATERIALS HAS BEEN ADVISED OF THE POSSIBILITY OF SUCH DAMAGE.

Skyworks products are not intended for use in medical, lifesaving or life-sustaining applications, or other equipment in which the failure of the Skyworks products could lead to personal injury, death, physical or environmental damage. Skyworks customers using or selling Skyworks products for use in such applications do so at their own risk and agree to fully indemnify Skyworks for any damages resulting from such improper use or sale.

Customers are responsible for their products and applications using Skyworks products, which may deviate from published specifications as a result of design defects, errors, or operation of products outside of published parameters or design specifications. Customers should include design and operating safeguards to minimize these and other risks. Skyworks assumes no liability for applications assistance, customer product design, or damage to any equipment resulting from the use of Skyworks products outside of stated published specifications or parameters.

Skyworks, the Skyworks symbol, and "Breakthrough Simplicity" are trademarks or registered trademarks of Skyworks Solutions, Inc., in the United States and other countries. Third-party brands and names are for identification purposes only, and are the property of their respective owners. Additional information, including relevant terms and conditions, posted at www.skyworksinc.com, are incorporated by reference.