



24-BIT, 96-kHz STEREO A/D CONVERTER WITH 6 × 2-CHANNEL MUX AND PGA

FEATURES

- Multiplexer and Programmable-Gain Amplifier (PGA)
 - 6×2-Channel Single-Ended Inputs
 - Multiplexed Output
 - Maximum Input Level: 2.4 V rms
 - Input Resistance: 50 kΩ, Minimum
 - PGA Gain: 11 to –11 dB Range, 0.5 dB/Step
- 24-Bit Delta-Sigma Stereo A/D Converter
- Antialiasing Filter Included
- Oversampling Decimation Filter
 - Oversampling Frequency: ×64
 - Pass-Band Ripple: ±0.05 dB
 - Stop-Band Attenuation: –65 dB
 - On-Chip High-Pass Filter: 0.91 Hz (48 kHz)
- High Performance
 - THD+N: 0.0023% (Typically)
 - SNR: 101 dB (Typically)
 - Dynamic Range: 102 dB (Typically)
- PCM Audio Interface
 - Master/Slave Mode Selectable
 - Data Formats: 24-Bit Left Justified, 24-Bit I²S, 16-, 24-Bit Right Justified
- Mode Control by Serial Interface:
 - With SPI Control (PCM1850)
 - With I²C Control (PCM1851)
- Sampling Rate: 16–96 kHz
- System Clock: 256 f_s, 384 f_s, 512 f_s, 768 f_s
- Dual Power Supplies: 5 V for Analog, 3.3 V for Digital
- Package: 32-Pin TQFP
- Lead-Free Product

APPLICATIONS

- DVD/HDD/DVD+HDD Recorder
- AV Amplifier Receiver
- CD Recorder
- MD Recorder
- Multi-Track Recorder
- Electric Musical Instrument

DESCRIPTION

The PCM1850/1851 is a high-performance, low-cost, single-chip stereo analog-to-digital converter with a single-ended analog front end that consists of a 6-stereo-input multiplexer and wide-range PGA. The PCM1850/1851 includes a delta-sigma modulator with 64-times oversampling, a digital decimation filter and a low-cut filter that removes the dc component of the input signal. For various applications, the PCM1850/1851 supports two modes (master and slave) and four data formats through a serial control interface, SPI for the PCM1850 and I²C for the PCM1851, respectively. The PCM1850/1851 is suitable for a wide variety of cost-sensitive DVD/CD/MD recorder and receiver applications where good performance and operation from a 5-V analog supply and 3.3-V digital supply is required. The PCM1850/1851 is fabricated using a highly advanced CMOS process and is available in a small 32-pin TQFP package.

ORDERING INFORMATION

PRODUCT	PACKAGE	PACKAGE CODE	OPERATION TEMPERATURE RANGE	PACKAGE MARKING	ORDERING NUMBER	TRANSPORT MEDIA
PCM1850PJT	32-Lead TQFP	32PJT	–40°C to 85°C	PCM1850	PCM1850PJT	Tray
					PCM1850PJTR	Tape and reel
PCM1851PJT	32-Lead TQFP	32PJT	–40°C to 85°C	PCM1851	PCM1851PJT	Tray
					PCM1851PJTR	Tape and reel



Please be aware that an important notice concerning availability, standard warranty, and use in critical applications of Texas Instruments semiconductor products and disclaimers thereto appears at the end of this data sheet.

Terminal Functions
PCM1850

TERMINAL		I/O	DESCRIPTIONS
NAME	PIN		
AGND	29	—	Analog GND
BCK	2	I/O	Bit clock input/output ⁽¹⁾
DGND	5	—	Digital GND
DOUT	3	O	Audio data output
LRCK	1	I/O	Sampling clock input/output ⁽¹⁾
MC	31	I	Mode control clock input ⁽²⁾
MD	32	I	Mode control data input ⁽²⁾
MOU TL	12	O	Multiplexer output, L-channel
MOU TR	11	O	Multiplexer output, R-channel
MS	30	I	Mode control select input ⁽³⁾
OVER	4	O	Overflow flag
RST	10	I	Reset, active LOW ⁽³⁾
SCKI	7	I	System clock input; 256 f _S , 384 f _S , 512 f _S or 768 f _S ⁽²⁾
TEST0	8	I	Test 0, must be connected to GND ⁽³⁾
TEST1	9	I	Test 1, must be connected to GND ⁽³⁾
V _{CC}	28	—	Analog power supply, 5-V
V _{DD}	6	—	Digital power supply, 3.3-V
V _{INL1}	13	I	Analog input 1, L-channel
V _{INL2}	15	I	Analog input 2, L-channel
V _{INL3}	17	I	Analog input 3, L-channel
V _{INL4}	19	I	Analog input 4, L-channel
V _{INL5}	21	I	Analog input 5, L-channel
V _{INL6}	23	I	Analog input 6, L-channel
V _{INR1}	14	I	Analog input 1, R-channel
V _{INR2}	16	I	Analog input 2, R-channel
V _{INR3}	18	I	Analog input 3, R-channel
V _{INR4}	20	I	Analog input 4, R-channel
V _{INR5}	22	I	Analog input 5, R-channel
V _{INR6}	24	I	Analog input 6, R-channel
V _{REFS}	25	—	Reference S decoupling capacitor (= 0.5 V _{CC})
V _{REF1}	26	—	Reference 1 decoupling capacitor (= 0.5 V _{CC})
V _{REF2}	27	—	Reference 2 decoupling capacitor (= V _{CC})

⁽¹⁾ Schmitt-trigger input with internal pulldown resistor (50 k Ω , typically)

⁽²⁾ Schmitt-trigger input, 5-V tolerant

⁽³⁾ Schmitt-trigger input with internal pulldown resistor (50 k Ω , typically), 5-V tolerant

Terminal Functions

PCM1851

TERMINAL		I/O	DESCRIPTIONS
NAME	PIN		
ADR	30	I	Mode control address select input ⁽¹⁾
AGND	29	—	Analog GND
BCK	2	I/O	Bit clock input/output ⁽²⁾
DGND	5	—	Digital GND
DOUT	3	O	Audio data output
LRCK	1	I/O	Sampling clock input/output ⁽²⁾
MOU TL	12	O	Multiplexer output, L-channel
MOU TR	11	O	Multiplexer output, R-channel
OVER	4	O	Overflow flag
$\overline{\text{RST}}$	10	I	Reset, active LOW ⁽¹⁾
SCKI	7	I	System clock input; 256 f _S , 384 f _S , 512 f _S or 768 f _S ⁽³⁾
SCL	31	I	Mode control clock input ⁽³⁾
SDA	32	I/O	Mode control data input/output ⁽⁴⁾
TEST0	8	I	Test 0, must be connected to GND ⁽¹⁾
TEST1	9	I	Test 1, must be connected to GND ⁽¹⁾
V _{CC}	28	—	Analog power supply, 5-V
V _{DD}	6	—	Digital power supply, 3.3-V
V _{INL1}	13	I	Analog input 1, L-channel
V _{INL2}	15	I	Analog input 2, L-channel
V _{INL3}	17	I	Analog input 3, L-channel
V _{INL4}	19	I	Analog input 4, L-channel
V _{INL5}	21	I	Analog input 5, L-channel
V _{INL6}	23	I	Analog input 6, L-channel
V _{INR1}	14	I	Analog input 1, R-channel
V _{INR2}	16	I	Analog input 2, R-channel
V _{INR3}	18	I	Analog input 3, R-channel
V _{INR4}	20	I	Analog input 4, R-channel
V _{INR5}	22	I	Analog input 5, R-channel
V _{INR6}	24	I	Analog input 6, R-channel
V _{REFS}	25	—	Reference S decoupling capacitor (= 0.5 V _{CC})
V _{REF1}	26	—	Reference 1 decoupling capacitor (= 0.5 V _{CC})
V _{REF2}	27	—	Reference 2 decoupling capacitor (= V _{CC})

⁽¹⁾ Schmitt-trigger input with internal pulldown resistor (50 k Ω , typically), 5-V tolerant

⁽²⁾ Schmitt-trigger input with internal pulldown resistor (50 k Ω , typically)

⁽³⁾ Schmitt-trigger input, 5-V tolerant

⁽⁴⁾ Schmitt-trigger input/open-drain LOW output, 5-V tolerant

ABSOLUTE MAXIMUM RATINGS

over operating free-air temperature range unless otherwise noted⁽¹⁾

Supply voltage: V_{CC}	-0.3 V to 6.5 V
Supply voltage: V_{DD}	-0.3 V to 4 V
Ground voltage differences: AGND, DGND	± 0.1 V
Digital input voltage: LRCK, BCK, DOUT, OVER	-0.3 V to ($V_{DD} + 0.3$ V) < 4 V
Digital input voltage: \overline{RST} , SCKI, MS (ADR) ⁽²⁾ , MC (SCL) ⁽²⁾ , MD (SDA) ⁽²⁾ , TEST0, TEST1	-0.3 V to 6.5 V
Analog input voltage: V_{INL1-6} , V_{INR1-6}	-3 V to ($V_{CC} + 3$ V) < 9 V
Analog input voltage: MOUTL, MOUTR, V_{REF1} , V_{REF2} , V_{REFS}	-0.3 V to ($V_{CC} + 0.3$ V) < 6.5 V
Input current (any pins except supplies)	± 10 mA
Ambient temperature under bias	-40°C to 125°C
Storage temperature	-55°C to 150°C
Junction temperature	150°C
Lead temperature (soldering)	260°C, 5 s
Package temperature (IR reflow, peak)	260°C

(1) Stresses beyond those listed under “absolute maximum ratings” may cause permanent damage to the device. These are stress ratings only, and functional operation of the device at these or any other conditions beyond those indicated under “recommended operating conditions” is not implied. Exposure to absolute-maximum-rated conditions for extended periods may affect device reliability.

(2) PCM1850 (PCM1851)

ELECTRICAL CHARACTERISTICS

All specifications at $T_A = 25^\circ\text{C}$, $V_{CC} = 5$ V, $V_{DD} = 3.3$ V, master mode, $f_S = 48$ kHz, system clock = 256 f_S , 24-bit data, unless otherwise noted

PARAMETER	TEST CONDITIONS	PCM1850PJT, PCM1851PJT			UNIT
		MIN	TYP	MAX	
DIGITAL INPUT/OUTPUT					
DATA FORMAT					
Audio data interface format		Left-justified, I ² S, right-justified			
Audio data bit length		16, 24			bits
Audio data format		MSB-first, 2s complement			
f_S Sampling frequency		16	48	96	kHz
System clock frequency	256 f_S	4.096	12.288	24.576	MHz
	384 f_S	6.144	18.432	36.864	
	512 f_S	8.192	24.576	49.152	
	768 f_S	12.288	36.864	—	
INPUT LOGIC					
V_{IH} ⁽¹⁾	Input logic level	2		V_{DD}	VDC
V_{IL} ⁽¹⁾		0		0.8	
V_{IH} ^{(2) (3)}		2		5.5	
V_{IL} ^{(2) (3)}		0		0.8	
I_{IH} ⁽²⁾	Input logic current	$V_{IN} = V_{DD}$		± 10	μA
I_{IL} ⁽²⁾		$V_{IN} = 0$		± 10	
I_{IH} ^{(1) (3)}		$V_{IN} = V_{DD}$		65 100	
I_{IL} ^{(1) (3)}		$V_{IN} = 0$		± 10	

(1) Pins 1, 2: LRCK, BCK (In slave mode, Schmitt-trigger input, with 50-k Ω typical pulldown resistor)

(2) Pins 7, 31, 32: SCKI, MC/SCL (PCM1850/1851), MD/SDA (PCM1850/1851) (Schmitt-trigger input, 5-V tolerant)

(3) Pins 8–10, 30: TEST0, TEST1, \overline{RST} , MS/ADR (PCM1850/1851) (Schmitt-trigger input, with 50-k Ω typical pulldown resistor, 5-V tolerant)

ELECTRICAL CHARACTERISTICS (Continued)

All specifications at $T_A = 25^\circ\text{C}$, $V_{CC} = 5\text{ V}$, $V_{DD} = 3.3\text{ V}$, master mode, $f_S = 48\text{ kHz}$, system clock = $256 f_S$, 24-bit data, unless otherwise noted

PARAMETER		TEST CONDITIONS	PCM1850PJT, PCM1851PJT			UNIT
			MIN	TYP	MAX	
OUTPUT LOGIC						
$V_{OH}^{(1)}$	Output logic level	$I_{OUT} = -4\text{ mA}$	2.8			VDC
$V_{OL}^{(1)(2)}$		$I_{OUT} = 4\text{ mA}$		0.5		
AFE MULTIPLEXER						
Input channels			6			
Input level for full scale			2	2.4		Vrms
Center voltage (V_{REF1})		Selected channel	$0.5 V_{CC}$			V
Center voltage (V_{REFS})		Unselected channel	$0.5 V_{CC}$			V
Input impedance		Selected channel	50	169		k Ω
		Unselected channel	50	57		
AFE PGA						
Gain range			-11	0	11	dB
Gain step			0.5			dB
Monotonicity			Specified			
Antialiasing filter frequency response		-3 dB , PGA gain = -5.5 dB	300			kHz
MONITOR OUTPUT						
Output level for full scale		AC-coupled, $>10\text{ k}\Omega$	$0.6 V_{CC}$			Vp-p
Output load		AC-coupled	10			k Ω
THD+N ⁽³⁾⁽⁴⁾		AC-coupled, $10\text{ k}\Omega$, 3 Vp-p output,	0.0016%			
S/N ratio ⁽³⁾⁽⁴⁾		AC-coupled, $10\text{ k}\Omega$	104			dB
Gain error ⁽³⁾⁽⁴⁾		AC-coupled, $10\text{ k}\Omega$	-3			% of FSR
Center voltage			$0.5 V_{CC}$			V
ADC						
Resolution			24			bits
Full scale input voltage			$0.6 V_{CC}$			Vp-p
ACCURACY						
Gain mismatch, channel-to-channel			± 1	± 3		% of FSR
Gain error			± 2	± 5		% of FSR
Bipolar zero error		High-pass filter bypass	± 2			% of FSR

(1) Pins 1–4: LRCK, BCK (in master mode), DOUT, OVER

(2) Pin 32: SDA (PCM1851) (open-drain LOW output)

(3) Analog performance specifications are tested with the System Two™ audio measurement system by Audio Precision™, using a 400-Hz HPF and 20-kHz LPF in the RMS mode at $f_{IN} = 1\text{ kHz}$.

(4) Reference level (0 dB) is specified as 2-V rms input on $V_{INL}[1:6]$ and $V_{INR}[1:6]$ pins with PGA gain of -5.5 dB .

ELECTRICAL CHARACTERISTICS (Continued)

All specifications at $T_A = 25^\circ\text{C}$, $V_{CC} = 5\text{ V}$, $V_{DD} = 3.3\text{ V}$, master mode, $f_S = 48\text{ kHz}$, system clock = $256 f_S$, 24-bit data, unless otherwise noted

PARAMETER	TEST CONDITIONS	PCM1850PJT, PCM1851PJT			UNIT	
		MIN	TYP	MAX		
DYNAMIC PERFORMANCE^{(1) (2)}						
THD+N ⁽³⁾	$f_S = 48\text{ kHz}$, $V_{IN} = -0.5\text{ dB}$ (1.89 Vrms)	0.0023%	0.004%			
	$f_S = 96\text{ kHz}^{(4)}$, $V_{IN} = -0.5\text{ dB}$ (1.89 Vrms)	0.0027%				
THD+N ⁽³⁾	$f_S = 48\text{ kHz}$, $V_{IN} = -60\text{ dB}$ (2 mVrms)	1%				
	$f_S = 96\text{ kHz}^{(4)}$, $V_{IN} = -60\text{ dB}$ (2 mVrms)	1%				
Dynamic range ⁽³⁾	$f_S = 48\text{ kHz}$, A-weighted	96	102		dB	
	$f_S = 96\text{ kHz}^{(4)}$, A-weighted		102			
S/N ratio ⁽³⁾	$f_S = 48\text{ kHz}$, A-weighted	96	101		dB	
	$f_S = 96\text{ kHz}^{(4)}$, A-weighted		102			
Channel separation (between L-ch and R-ch) ⁽³⁾	$f_S = 48\text{ kHz}$	92	98		dB	
	$f_S = 96\text{ kHz}^{(4)}$		100			
Channel separation (among channels) ⁽⁵⁾	$f_S = 48\text{ kHz}$	90	96		dB	
	$f_S = 96\text{ kHz}^{(4)}$		96			
DIGITAL FILTER PERFORMANCE						
Pass band			0.454 f_S		Hz	
Stop band		0.583 f_S			Hz	
Pass-band ripple			± 0.05		dB	
Stop-band attenuation		-65			dB	
Delay time			17.4/ f_S		s	
HPF frequency response	-3 dB		0.019 f_S		mHz	
POWER SUPPLY REQUIREMENTS						
V_{CC}	Voltage range		4.5	5	5.5	VDC
V_{DD}			2.7	3.3	3.6	VDC
I_{CC}	Supply current ⁽⁶⁾	Operation		28	35	mA
		Power down ⁽⁷⁾		190		μA
I_{DD}	Supply current ⁽⁶⁾	$f_S = 48\text{ kHz}$		6	10	mA
		$f_S = 96\text{ kHz}^{(4)}$		12		
		Power down ⁽⁷⁾ , PCM1850		80		μA
		Power down ⁽⁷⁾ , PCM1851		280		
Power dissipation, operation		$f_S = 48\text{ kHz}$		160	208	mW
		$f_S = 96\text{ kHz}^{(4)}$		180		
Power dissipation, power down ⁽⁷⁾		PCM1850		1.2		mW
		PCM1851		1.9		
TEMPERATURE RANGE						
Operation temperature		-40		85	$^\circ\text{C}$	
Thermal resistance (θ_{JA})			80		$^\circ\text{C/W}$	

(1) Analog performance specifications are tested with the System Two™ audio measurement system by Audio Precision™, using a 400-Hz HPF and 20-kHz LPF in the RMS mode at $f_{IN} = 1\text{ kHz}$.

(2) Reference level (0 dB) is specified as 2-V rms input on $V_{INL}[1:6]$ and $V_{INR}[1:6]$ pins with PGA gain of -5.5 dB.

(3) Unselected channel inputs are terminated to AGND with 0.33 μF .

(4) $f_S = 96\text{ kHz}$, system clock = $256 f_S$.

(5) 2-V rms input is applied to all unselected channels, and input of selected channel is terminated to AGND with 0.33 μF .

(6) Minimum load on DOUT (pin 3), BCK (pin 2), LRCK (pin 1)

(7) Halt SCKI, BCK, LRCK.

TYPICAL PERFORMANCE CURVES OF INTERNAL FILTER

DIGITAL FILTER

Decimation Filter Frequency Response

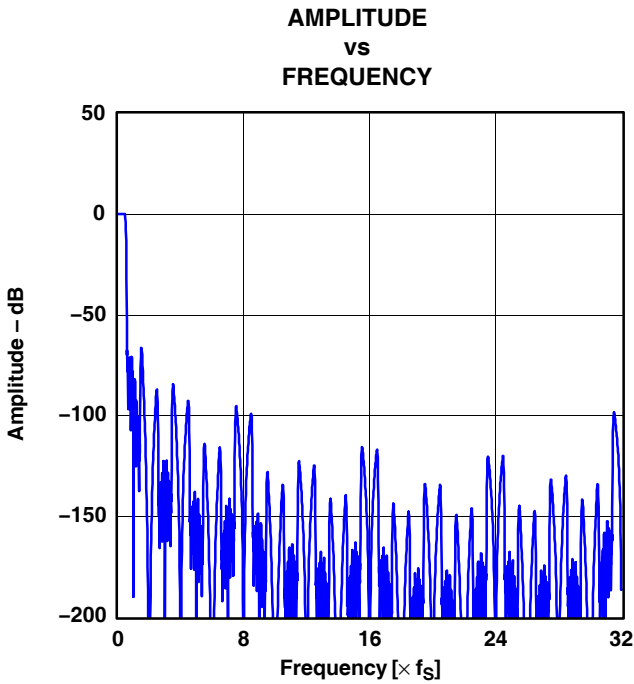

Figure 1. Overall Characteristics

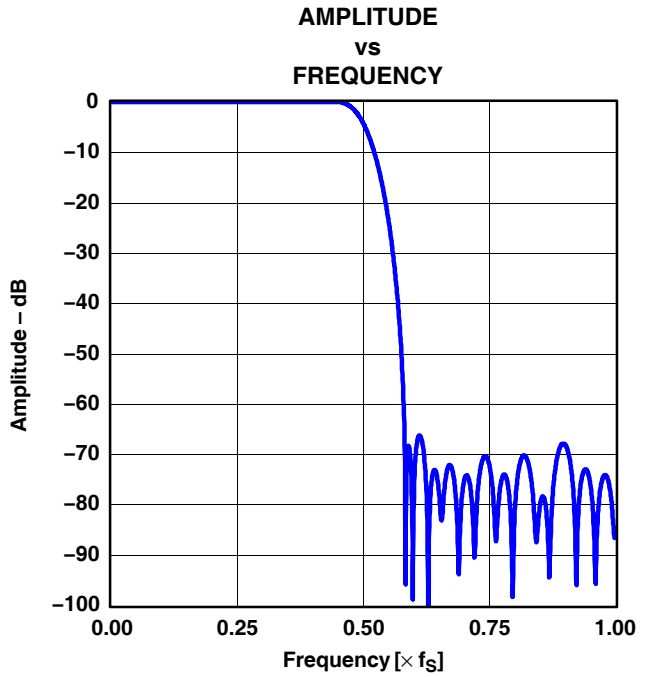

Figure 2. Stop-Band Attenuation Characteristics

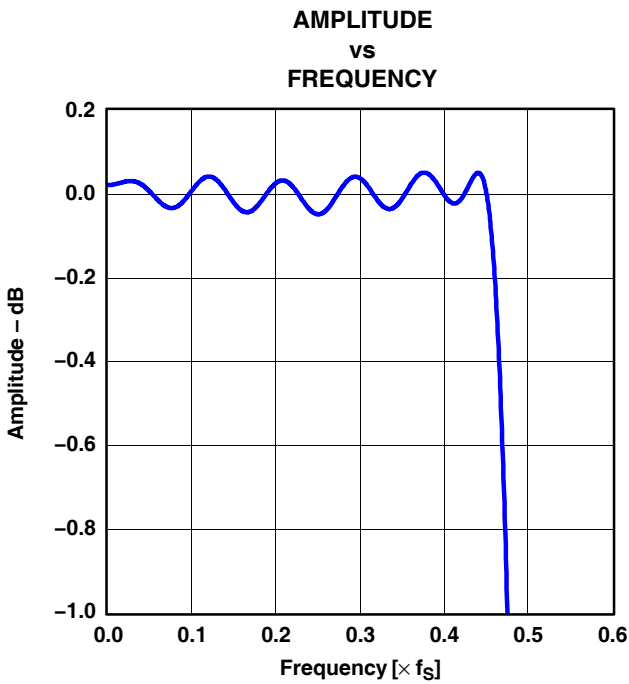

Figure 3. Pass-Band Ripple Characteristics

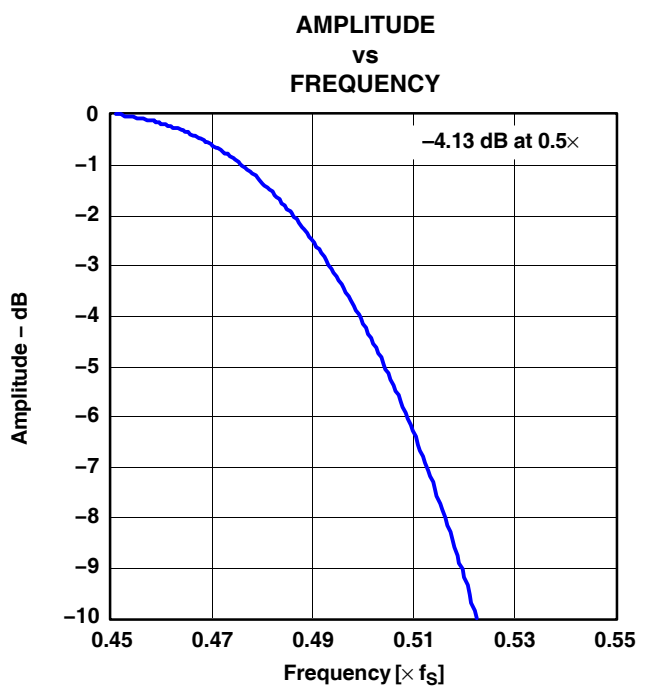

Figure 4. Transition-Band Characteristics

All specifications at $T_A = 25^\circ\text{C}$, $V_{CC} = 5\text{ V}$, $V_{DD} = 3.3\text{ V}$, master mode, $f_S = 48\text{ kHz}$, system clock = $256 f_S$, 24-bit data, unless otherwise noted

High-Pass Filter Frequency Response

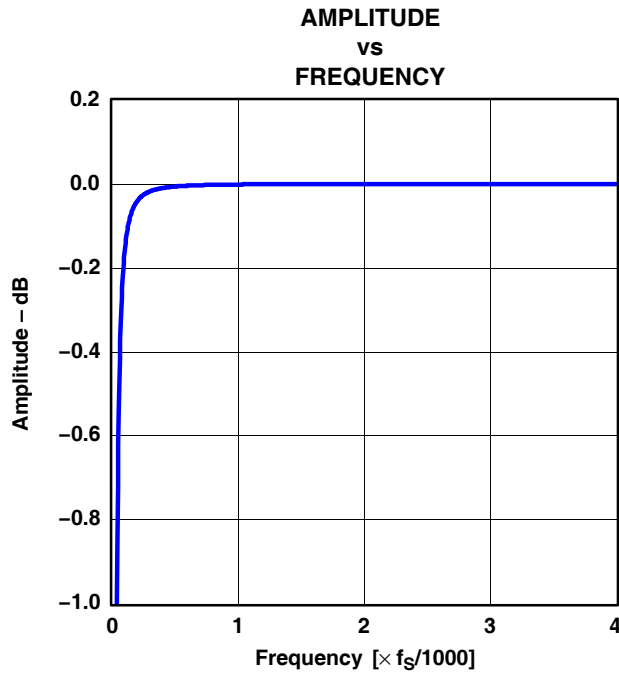

Figure 5. HPF Pass-Band Characteristics

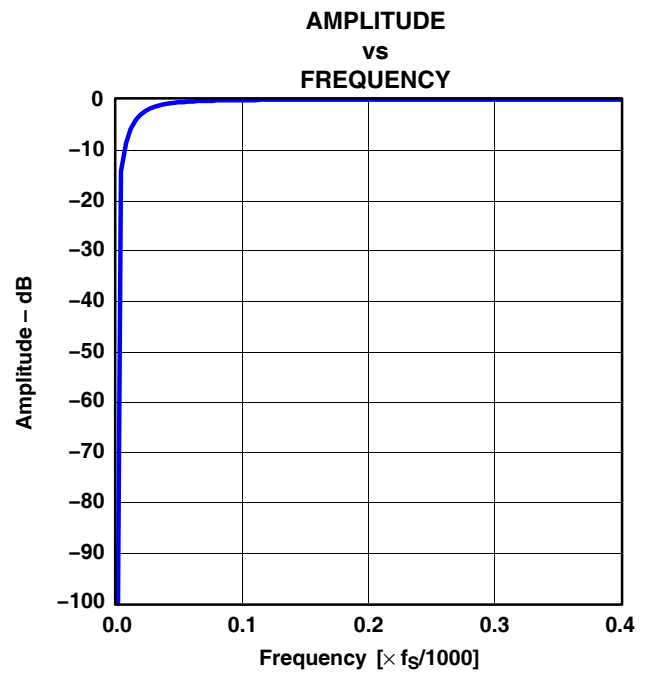

Figure 6. HPF Stop-Band Characteristics

ANALOG FILTER

Antialiasing Filter Frequency Response (at PGA gain = -5.5 dB)

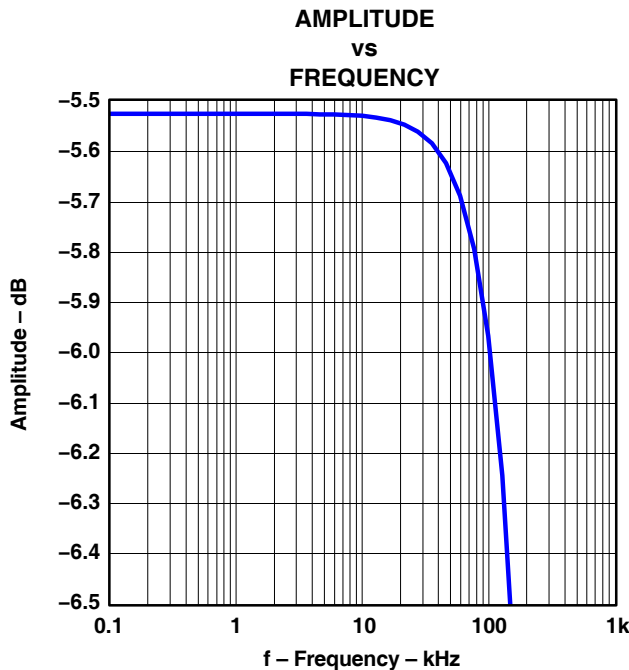

Figure 7. Antialiasing Filter Pass-Band Characteristics

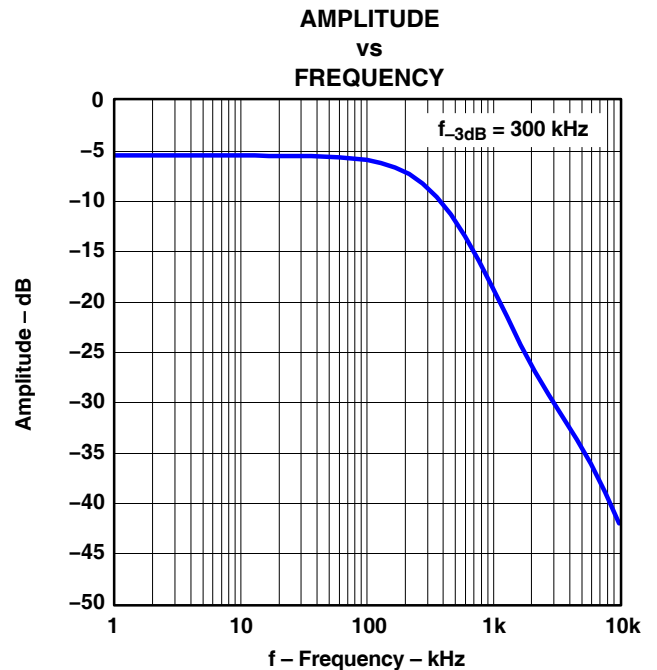

Figure 8. Antialiasing Filter Stop-Band Characteristics

All specifications at $T_A = 25^\circ\text{C}$, $V_{CC} = 5 \text{ V}$, $V_{DD} = 3.3 \text{ V}$, master mode, $f_S = 48 \text{ kHz}$, system clock = $256 f_S$, 24-bit data, unless otherwise noted

TYPICAL PERFORMANCE CURVES AT PGA GAIN = -5.5 dB

TOTAL HARMONIC DISTORTION + NOISE
vs
FREE-AIR TEMPERATURE

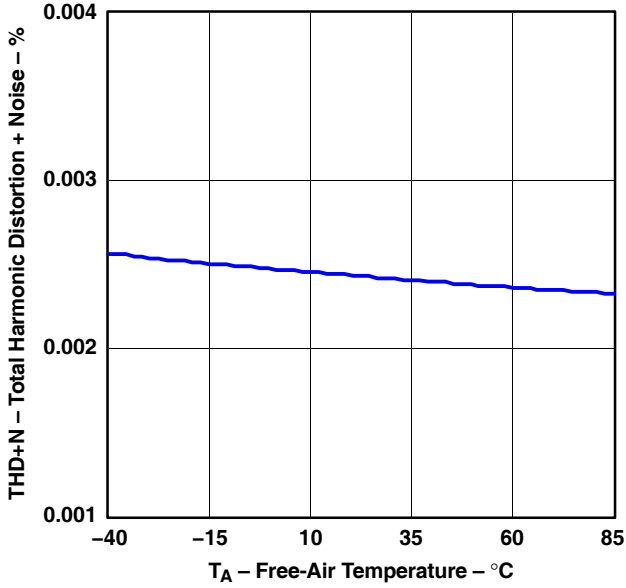

Figure 9

DYNAMIC RANGE and SNR
vs
FREE-AIR TEMPERATURE

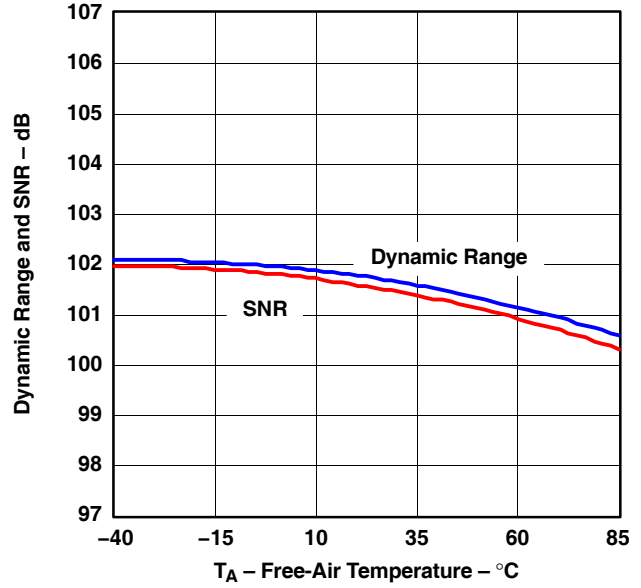

Figure 10

TOTAL HARMONIC DISTORTION + NOISE
vs
SUPPLY VOLTAGE

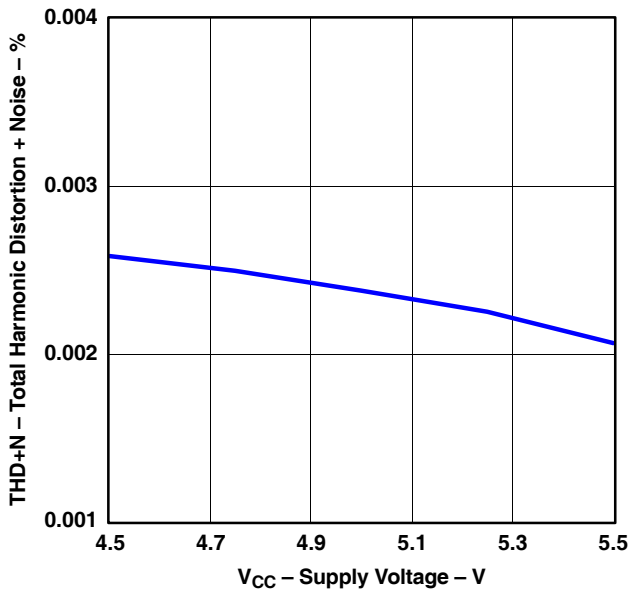

Figure 11

DYNAMIC RANGE and SNR
vs
SUPPLY VOLTAGE

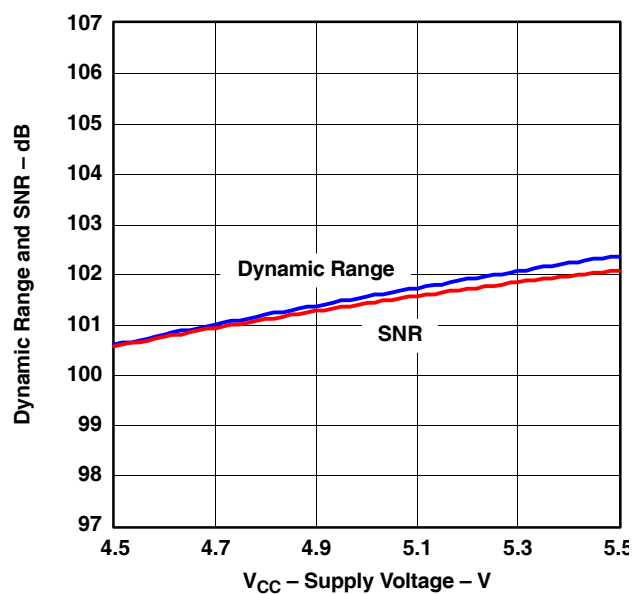

Figure 12

All specifications at $T_A = 25^\circ\text{C}$, $V_{CC} = 5\text{ V}$, $V_{DD} = 3.3\text{ V}$, master mode, $f_S = 48\text{ kHz}$, system clock = $256 f_S$, 24-bit data, unless otherwise noted

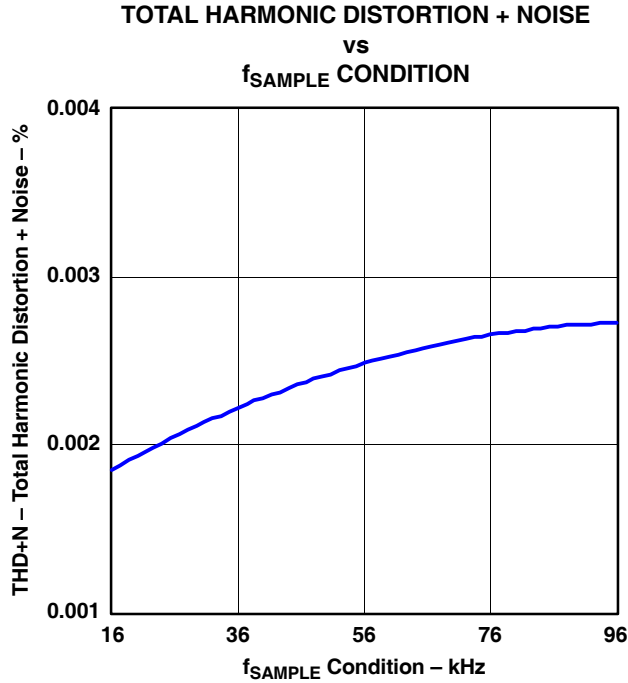

Figure 13

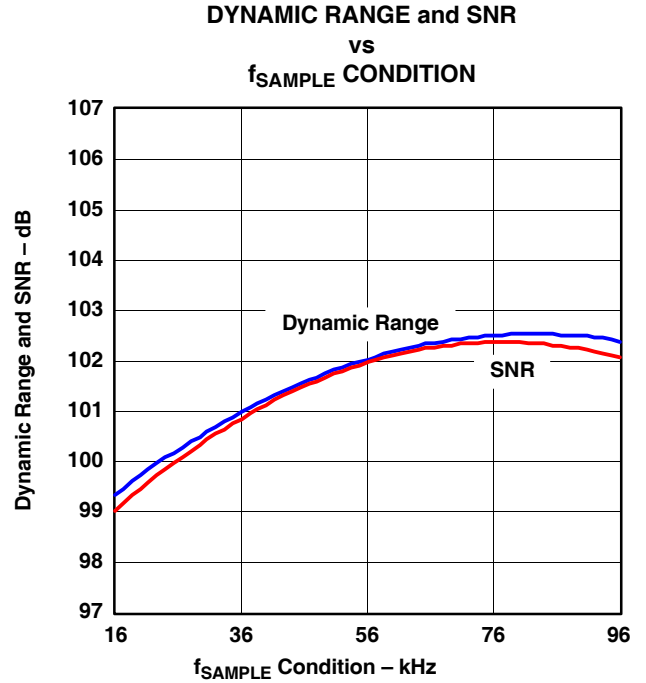

Figure 14

OUTPUT SPECTRUM

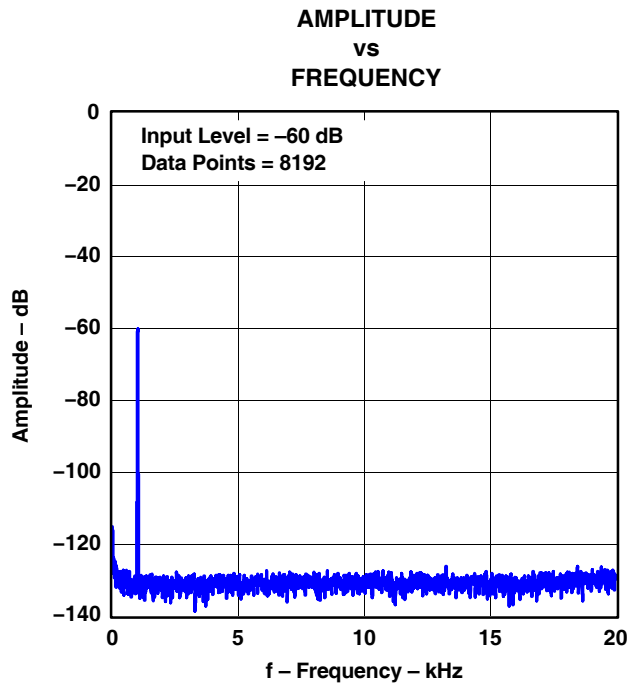

Figure 15

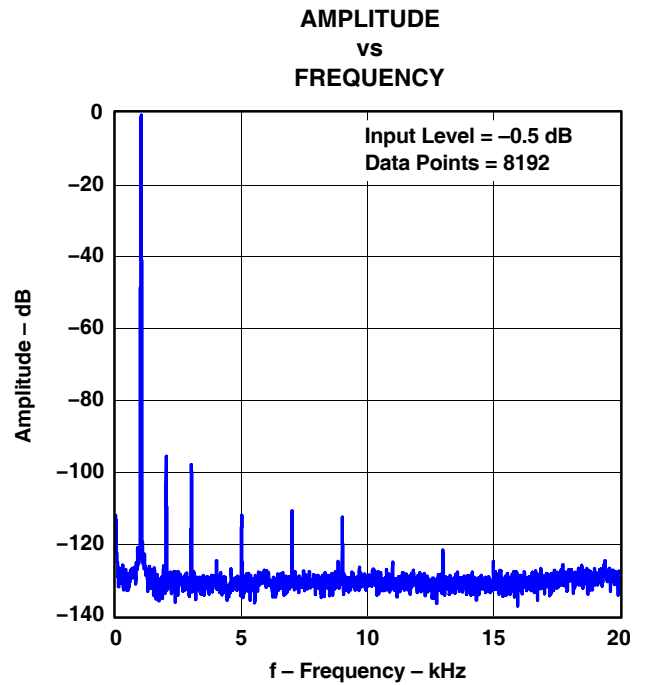

Figure 16

All specifications at T_A = 25°C, V_{CC} = 5 V, V_{DD} = 3.3 V, master mode, f_S = 48 kHz, system clock = 256 f_S, 24-bit data, unless otherwise noted

TOTAL HARMONIC DISTORTION + NOISE
vs
SIGNAL LEVEL

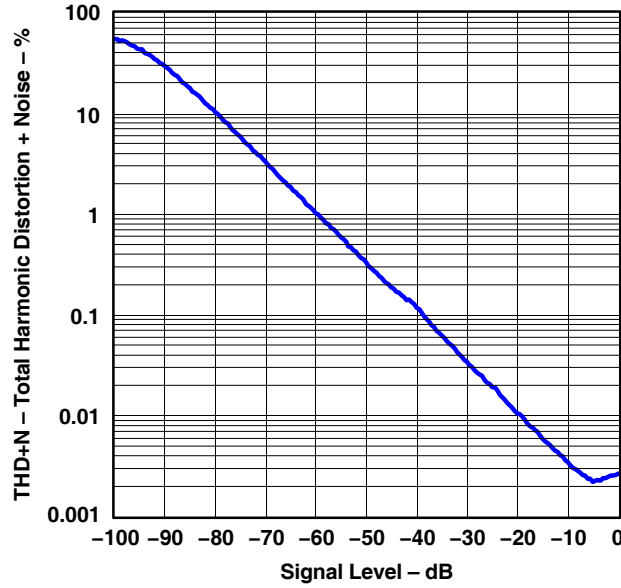

Figure 17

SUPPLY CURRENT

SUPPLY CURRENT
vs
f_{SAMPLE} CONDITION

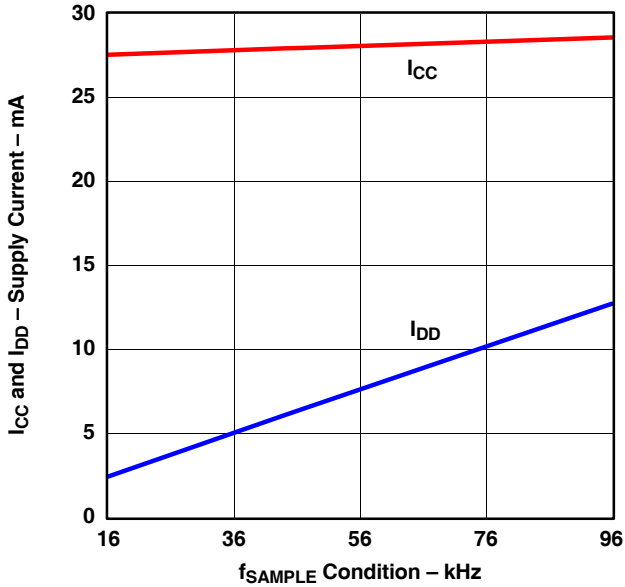

Figure 18

PGA GAIN LINEARITY

OVERALL GAIN
vs
GAIN SETTING

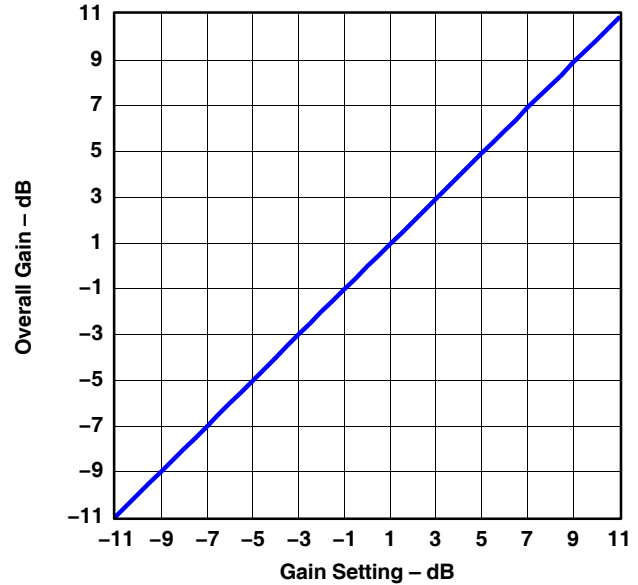

Figure 19

All specifications at T_A = 25°C, V_{CC} = 5 V, V_{DD} = 3.3 V, master mode, f_S = 48 kHz, system clock = 256 f_S, 24-bit data, unless otherwise noted

SYSTEM CLOCK

The PCM1850/1851 supports $256 f_s$, $384 f_s$, $512 f_s$, and $768 f_s$ as the system clock, where f_s is the audio sampling frequency. The system clock must be supplied on SCKI (pin 7).

The PCM1850/1851 has a system clock detection circuit which automatically senses if the system clock is operating at $256 f_s$, $384 f_s$, $512 f_s$ or $768 f_s$ in slave mode. In master mode, the system clock frequency must be selected by mode control via the serial port. The $768-f_s$ system clock is not available in master mode or for $f_s = 88.2$ kHz and 96 kHz in the slave mode. The system clock is divided into $128 f_s$ and $64 f_s$ automatically, and these frequencies are used to operate the digital filter and the delta-sigma modulator, respectively.

Table 1 shows the relationship of typical sampling frequency to system clock frequency, and Figure 20 shows system clock timing.

Table 1. Sampling Frequency and System Clock Frequency

SAMPLING RATE FREQUENCY (kHz)	SYSTEM CLOCK FREQUENCY (MHz)			
	$256 f_s$	$384 f_s$	$512 f_s$	$768 f_s$ ⁽¹⁾
32	8.192	12.288	16.384	24.576
44.1	11.2896	16.9344	22.5792	33.8688
48	12.288	18.432	24.576	36.864
64	16.384	24.576	32.768	49.152
88.2	22.5792	33.8688	45.1584	—
96	24.576	36.864	49.152	—

⁽¹⁾ Slave mode only

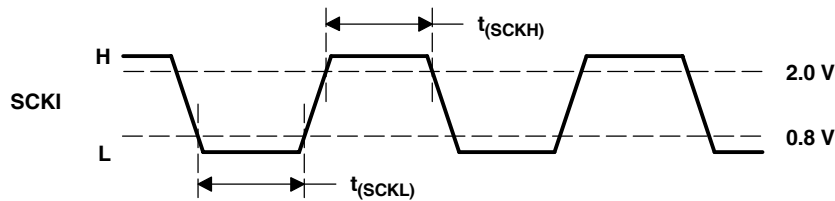

SYMBOL	PARAMETER	MIN	MAX	UNIT
t_{SCKH}	System clock pulse duration, HIGH	8		ns
t_{SCKL}	System clock pulse duration, LOW	8		ns

Figure 20. System Clock Timing

POWER-ON RESET SEQUENCE

The PCM1850/1851 has an internal power-on reset circuit, and initialization (reset) is performed automatically at the time that the power supply (V_{DD}) exceeds 2.2 V (typ). While $V_{DD} < 2.2$ V (typ) and for 1024 system clocks after $V_{DD} > 2.2$ V (typ), the PCM1850/1851 stays in the reset state and the digital output is forced to zero. The digital output is valid after the reset state is released and the time of $4500/f_S$ has passed. At the moment of the power-on reset release, the PCM1850/1851 does not need a system clock. Figure 21 illustrates the internal power-on reset timing and the digital output for power-on reset.

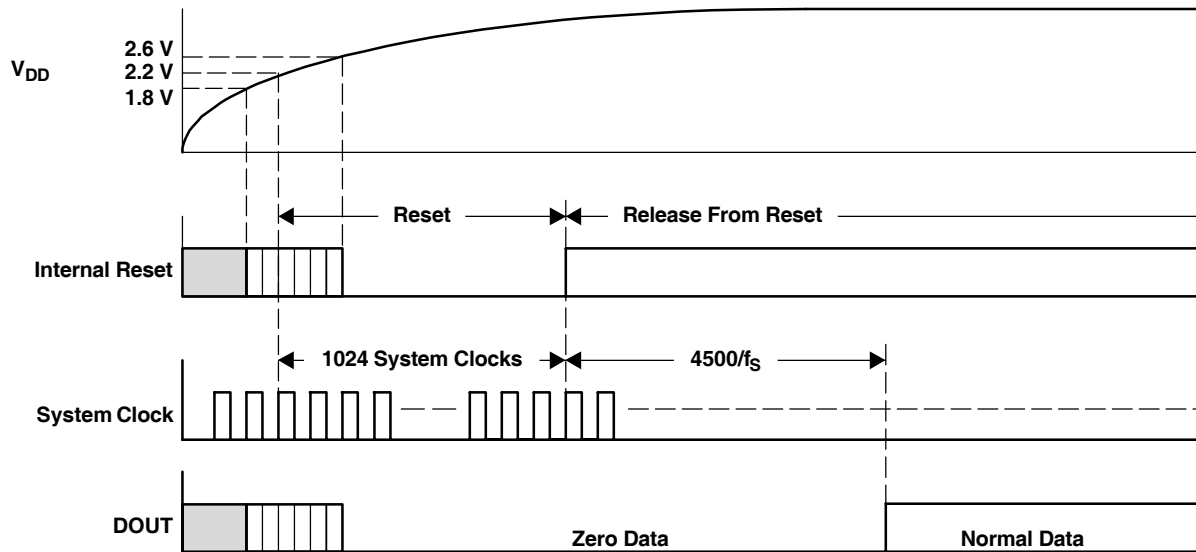

Figure 21. Internal Power-On Reset Timing

ANALOG FRONT END

The PCM1850/1851 has a built-in analog front-end circuit, which is shown in the block diagram of Figure 22. Selection of the multiplexer input and PGA gain is controlled by mode control via the serial port as shown in Table 2 and Table 3. The change of the input selection and the gain selection is performed immediately after the serial control packet for the change is sent. A popping noise or other unexpected transient response could be generated in the audio signal during channel and gain change. Because the PCM1850/1851 has no zero-cross detection and no other buffering capability for channel and gain change, appropriate data handling in the digital domain is recommended to control transients.

The PCM1850/1851 analog front end permits only ac input via an input capacitor; dc input is prohibited. A signal source resistance of less than 1 k Ω is recommended for the V_{INxx} pins.

All unselected channel inputs are terminated V_{REFS} ($= 0.5 V_{CC}$) using a resistor, typically 57 k Ω .

The PCM1850/1851 employs MOUTL/R pins (pins 12 and 11) to monitor the multiplexer output. The load on these pins must be ac-coupled and not less than 10 k Ω . The full-scale output level is typically $0.6 V_{CC}$.

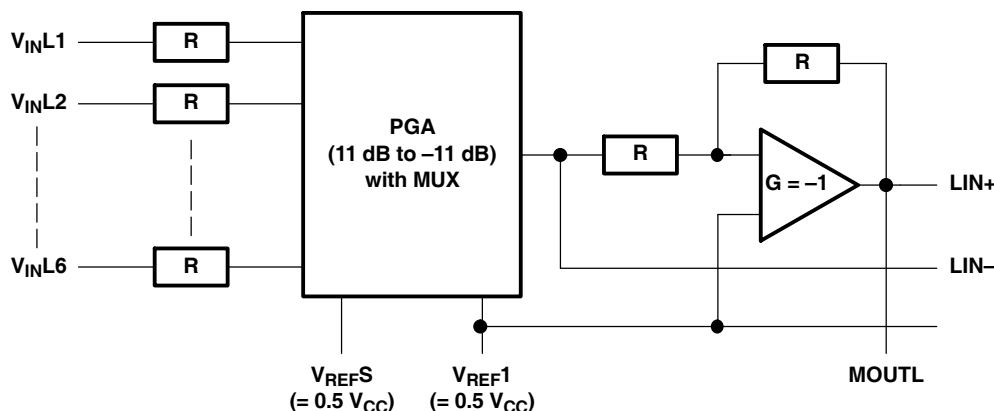

Figure 22. Analog Front-End Block Diagram (L-channel)

Table 2. Multiplexer Input Selection

CH2	CH1	CH0	CHANNEL
0	0	0	Mute
0	0	1	Channel 1 (default)
0	1	0	Channel 2
0	1	1	Channel 3
1	0	0	Channel 4
1	0	1	Channel 5
1	1	0	Channel 6
1	1	1	Mute

Table 3. PGA Gain Selection

PG5	PG4	PG3	PG2	PG1	PG0	PGA GAIN [dB]	R _{IN} [kΩ, Typical]
0	0	1	0	1	0	-11 (default)	201
0	0	1	0	1	1	-10.5	199
0	0	1	1	0	0	-10	196
0	0	1	1	0	1	-9.5	193
0	0	1	1	1	0	-9	190
0	0	1	1	1	1	-8.5	188
0	1	0	0	0	0	-8	185
0	1	0	0	0	1	-7.5	181
0	1	0	0	1	0	-7	178
0	1	0	0	1	1	-6.5	175
0	1	0	1	0	0	-6	172
0	1	0	1	0	1	-5.5	169
0	1	0	1	1	0	-5	165
0	1	0	1	1	1	-4.5	162
0	1	1	0	0	0	-4	158
0	1	1	0	0	1	-3.5	155
0	1	1	0	1	0	-3	151
0	1	1	0	1	1	-2.5	147
0	1	1	1	0	0	-2	144
0	1	1	1	0	1	-1.5	140
0	1	1	1	1	0	-1	136
0	1	1	1	1	1	-0.5	133
1	0	0	0	0	0	0	129
1	0	0	0	0	1	0.5	125
1	0	0	0	1	0	1	122
1	0	0	0	1	1	1.5	118
1	0	0	1	0	0	2	114
1	0	0	1	0	1	2.5	111
1	0	0	1	1	0	3	107
1	0	0	1	1	1	3.5	103
1	0	1	0	0	0	4	100
1	0	1	0	0	1	4.5	96
1	0	1	0	1	0	5	93
1	0	1	0	1	1	5.5	89
1	0	1	1	0	0	6	86
1	0	1	1	0	1	6.5	83
1	0	1	1	1	0	7	80
1	0	1	1	1	1	7.5	77
1	1	0	0	0	0	8	73
1	1	0	0	0	1	8.5	70
1	1	0	0	1	0	9	68
1	1	0	0	1	1	9.5	65
1	1	0	1	0	0	10	62
1	1	0	1	0	1	10.5	59
1	1	0	1	1	0	11	57

NOTE: $R_{IN}(k\Omega, \text{typical}) = \frac{258}{1 + 10^{(\text{GAIN}/20)}}$

The PCM1850/1851 becomes mute for PG[5:0] values other than those listed.

SERIAL AUDIO DATA INTERFACE

The PCM1850/1851 interfaces with the audio system through BCK (pin 2), LRCK (pin 1), and DOUT (pin 3).

Interface Mode

The PCM1850/1851 supports both master and slave modes as interface modes, and they are selected by mode control via the serial port as shown in Table 4.

In master mode, the PCM1850/1851 provides the timing for serial audio data communications between the PCM1850/1851 and the digital audio processor or external circuit. While in slave mode, the PCM1850/1851 receives the timing for data transfer from an external controller.

Table 4. Interface Mode

MD1	MD0	INTERFACE MODE
0	0	Slave mode (256 f _S , 384 f _S , 512 f _S , 768 f _S) (default)
0	1	Master mode (256 f _S)
1	0	Master mode (384 f _S)
1	1	Master mode (512 f _S)

Master Mode

In master mode, BCK and LRCK work as output pins, and these pins are controlled by timing which is generated in the clock and timing control circuit of the PCM1850/1851. The frequency of BCK is fixed at 64 × LRCK. A 768-f_S system clock is not available in master mode.

Slave Mode

In slave mode, BCK and LRCK work as input pins. The PCM1850/1851 accepts the 64 BCK/LRCK or 48 BCK/LRCK (only for 384 f_S SCKI) format. A 768-f_S system clock is not available for f_S = 88.2 kHz and 96 kHz in slave mode.

Data Format

The PCM1850/1851 supports four audio data formats in both master and slave modes, and they are selected by mode control via the serial port as shown in Table 5. Figure 23 illustrates the data formats in both slave and master modes.

Table 5. Data Format

FORMAT NO.	FMT2	FMT1	FMT0	FORMAT
0	1	0	1	Left-justified, 24-bit
1	1	0	0	I ² S, 24-bit, (default)
2	0	0	0	Right-justified, 24-bit
3	0	1	1	Right-justified, 16-bit

FORMAT 0: FMT[2:0] = 101b

24-Bit, MSB-First, Left-Justified

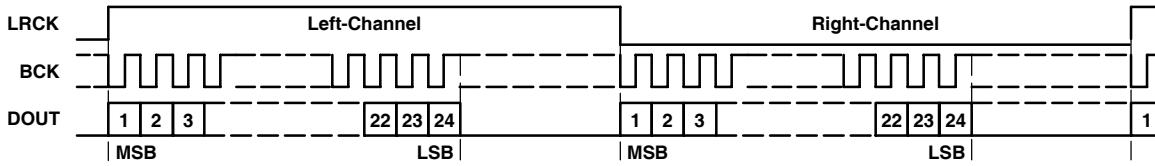

FORMAT 1: FMT[2:0] = 100b

24-Bit, MSB-First, I²S

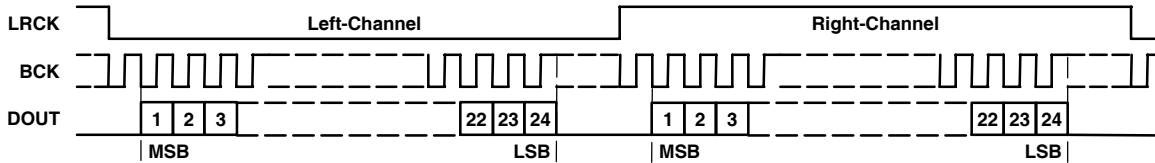

FORMAT 2: FMT[2:0] = 000b

24-Bit, MSB-First, Right-Justified

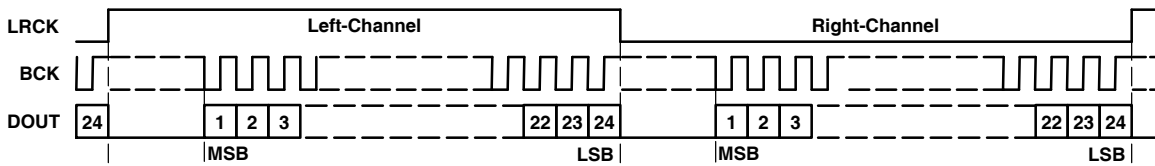

FORMAT 3: FMT[2:0] = 011b

16-Bit, MSB-First, Right-Justified

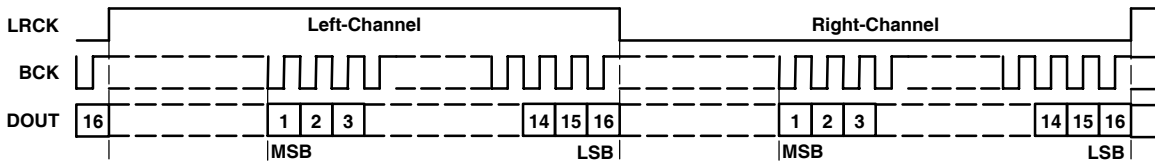
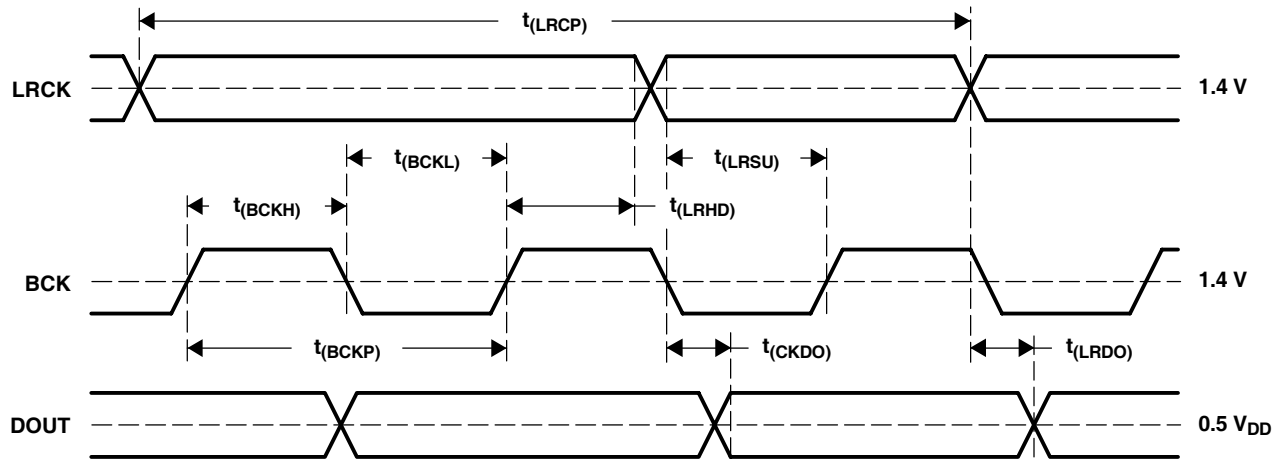

Figure 23. Audio Data Format
(LRCK, BCK Work as Inputs in Slave Mode and Outputs in Master Mode)

Interface Timing

Figure 24 and Figure 25 illustrate the interface timing in slave and master modes, respectively.



SYMBOL	PARAMETER	MIN	TYP	MAX	UNIT
$t_{(BCKP)}$	BCK period	150			ns
$t_{(BCKH)}$	BCK pulse duration, HIGH	60			ns
$t_{(BCKL)}$	BCK pulse duration, LOW	60			ns
$t_{(LRSU)}$	LRCK setup time to BCK rising edge	20			ns
$t_{(LRHD)}$	LRCK hold time to BCK rising edge	20			ns
$t_{(LRCP)}$	LRCK period	10			μ s
$t_{(CKDO)}$	Delay time, BCK falling edge to DOUT valid	-10		20	ns
$t_{(LRDO)}$	Delay time, LRCK edge to DOUT valid	-10		20	ns
t_r	Rise time of all signals			10	ns
t_f	Fall time of all signals			10	ns

NOTE: Timing measurement reference level is $(V_{IH} + V_{IL}) / 2$. Rise and fall times are measured from 10% to 90% of IN/OUT signal swing. Load capacitance of DOUT is 20 pF.

Figure 24. Audio Data Interface Timing (Slave Mode: LRCK, BCK Work as Inputs)

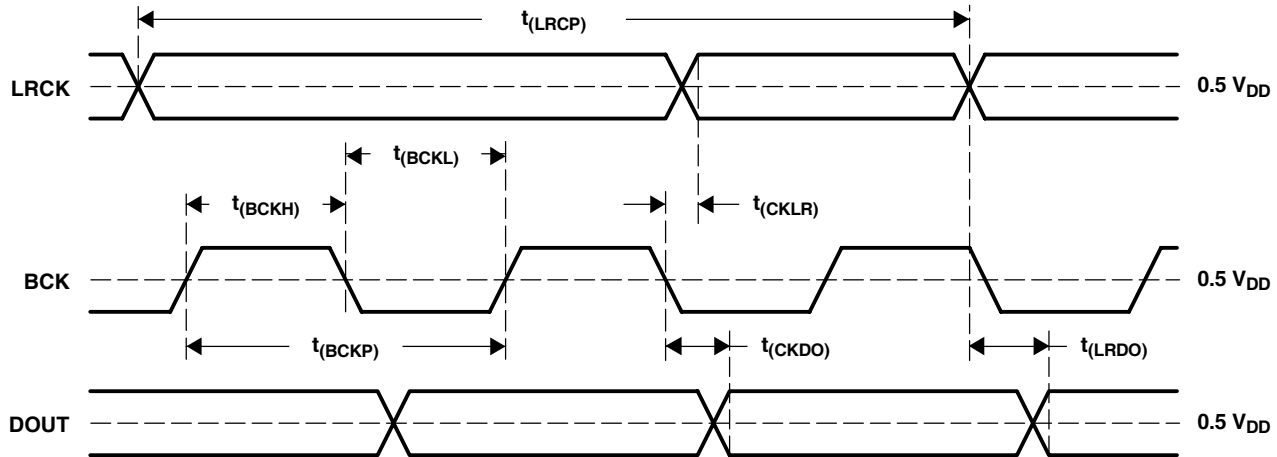

SYMBOL	PARAMETER	MIN	TYP	MAX	UNIT
$t_{(BCKP)}$	BCK period	150	$1/(64 f_S)$	1000	ns
$t_{(BCKH)}$	BCK pulse duration, HIGH	60	$0.5 t_{(BCKP)}$	400	ns
$t_{(BCKL)}$	BCK pulse duration, LOW	60	$0.5 t_{(BCKP)}$	400	ns
$t_{(CKLR)}$	Delay time, BCK falling edge to LRCK valid	-10		20	ns
$t_{(LRCP)}$	LRCK period	10	$1/f_S$	60	μ s
$t_{(CKDO)}$	Delay time, BCK falling edge to DOUT valid	-10		20	ns
$t_{(LRDO)}$	Delay time, LRCK edge to DOUT valid	-10		20	ns
t_r	Rise time of all signals			10	ns
t_f	Fall time of all signals			10	ns

NOTE: Timing measurement reference level is $(V_{IH} + V_{IL}) / 2$. Rise and fall times are measured from 10% to 90% of IN/OUT signal swing. Load capacitance of all signals is 20 pF.

Figure 25. Audio Data Interface Timing (Master Mode: LRCK, BCK Work as Outputs)

SYNCHRONIZATION WITH DIGITAL AUDIO SYSTEM

In slave mode, the PCM1850/1851 operates under LRCK, synchronized with system clock SCKI. The PCM1850/1851 does not need a specific phase relationship between LRCK and SCKI, but does require the synchronization of LRCK and SCKI.

If the relationship between LRCK and SCKI changes more than ± 6 BCKs for 64 BCKs/frame (± 5 BCKs for 48 BCKs/frame) during one sample period due to LRCK or SCKI jitter, internal operation of the ADC halts within $1/f_s$ and digital output is forced into the BPZ code until resynchronization between LRCK and SCKI is completed.

In the case of changes less than ± 5 BCKs for 64 BCKs/frame (± 4 BCKs for 48 BCK/frame), resynchronization with simultaneous discontinuity in the digital output does not occur.

Figure 26 illustrates the digital output response for loss of synchronization and resynchronization. During undefined data, the PCM1850/1851 might generate some noise in the audio signal. Also, the transition of normal to undefined data and undefined or zero data to normal creates a discontinuity of data in the digital output, which could generate some noise in the audio signal.

It is recommended to set $\overline{\text{RST}}$ (pin 10) to LOW to get stable analog performance when the sampling rate, interface mode, or data format is changed.

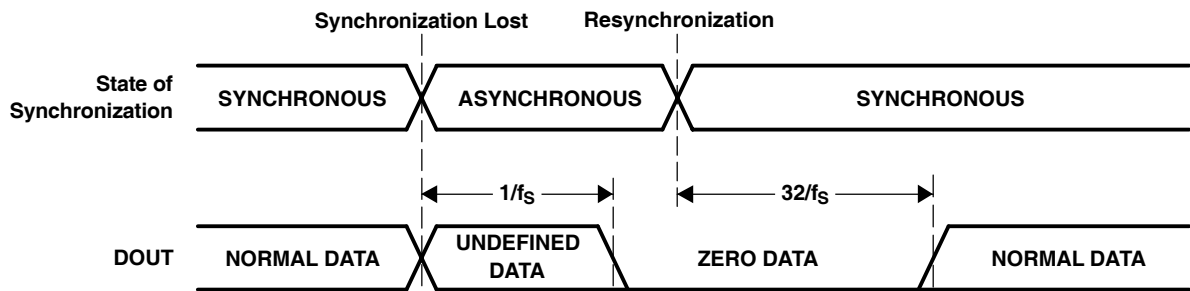

Figure 26. ADC Digital Output for Loss of Synchronization and Resynchronization

Power-Down Control

$\overline{\text{RST}}$ (pin 10) controls the entire ADC operation. During reset mode, the supply current of the analog section is shut off and the digital section is initialized. DOUT (pin 3) is also disabled. Halting SCKI, BCK, and LRCK is recommended to minimize power dissipation.

$\overline{\text{RST}}$	POWER-DOWN MODE
LOW	Reset and power-down modes
HIGH	Normal operation mode

Overflow Flag Output

The PCM1850/1851 has an output flag (pin 4) that indicates when overflow occurs in the L-channel or R-channel, and this flag remains HIGH at least during the $8192/f_s$ time for a momentary overflow occurrence.

HPF Bypass Control

The built-in HPF function for dc component rejection can be bypassed via the serial port. In bypass mode, the dc component of the analog input signal, the internal dc offset, etc., are converted and included in the digital output data.

BYP	HPF (HIGH-PASS FILTER) MODE
0	Normal (no dc component on DOUT) mode (default)
1	Bypass (dc component on DOUT) mode

System Reset Control

The system reset control is used to resynchronize the system via the serial port when the system clock frequency, interface mode, and data format are changed. Change them while SRST = LOW. If they are changed during normal operation, analog performance can be degraded.

SRST	SYSTEM RESET
0	Resynchronization
1	Normal operation (default)

Mode Register Reset Control

The MRST bit is used to reset the mode control register to its default settings via the serial port.

MRST	MODE REGISTER RESET
0	Set default value
1	Normal operation (default)

SPI SERIAL CONTROL PORT FOR MODE CONTROL (PCM1850)

The user-programmable built-in functions of the PCM1850 can be controlled through a serial control port with the SPI format. All operations for the serial control port use 16-bit data words. Figure 27 shows the control data word format. The most significant bit must be set to 0. There are seven bits, labeled IDX[6:0], that set the register index (or address) for write operations. The least significant eight bits, D[7:0], contain the data to be written to the register specified by IDX[6:0].

Figure 28 shows the functional timing diagram for writing to the serial control port. MS (pin 30) is held at a logic 1 state until a register needs to be written. To start the register write cycle, MS is set to logic 0. Sixteen clocks are then provided on MC (pin 31), corresponding to the 16 bits of the control data word on MD (pin 32). After the sixteenth clock cycle has completed, the data is latched into the indexed mode control register in the write operation. To write the next data word, MS must be set to 1 once.

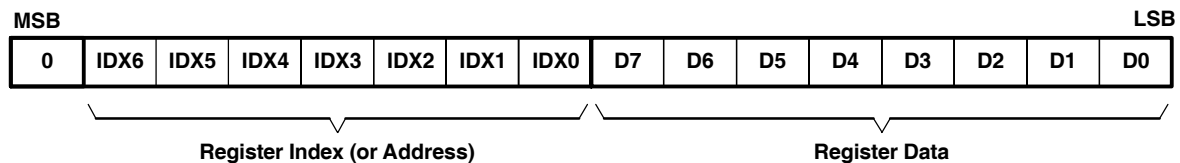

Figure 27. Control Data Word Format for MD

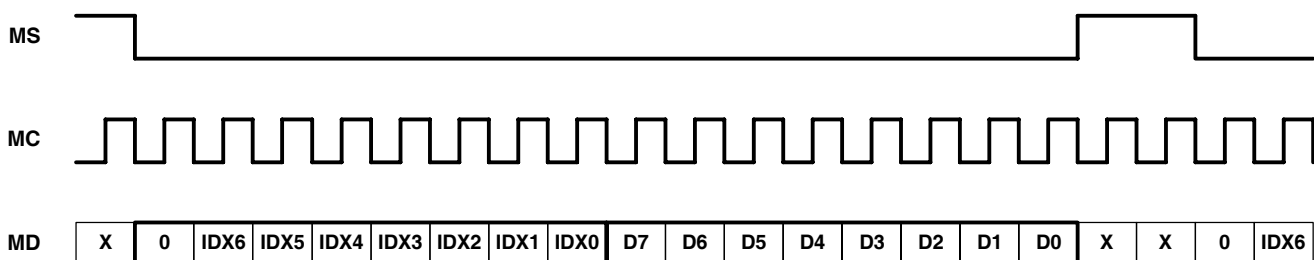
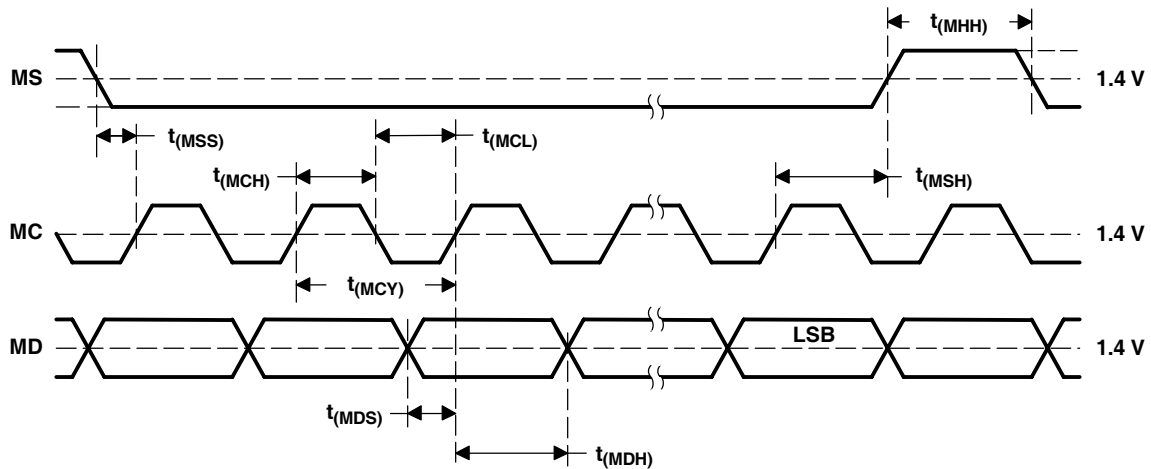

Figure 28. Serial Control Format

CONTROL INTERFACE TIMING REQUIREMENTS (PCM1850)

Figure 29 shows a detailed timing diagram for the serial control interface of the PCM1850. These timing parameters are critical for proper control port operation.



SYMBOL	PARAMETERS	MIN	MAX	UNITS
$t_{(MCY)}$	MC pulse cycle time	100		ns
$t_{(MCL)}$	MC LOW level time	40		ns
$t_{(MCH)}$	MC HIGH level time	40		ns
$t_{(MHH)}$	MS HIGH level time	80		ns
$t_{(MSS)}$	MS falling edge to MC rising edge	15		ns
$t_{(MSH)}$	MS hold time ⁽¹⁾	15		ns
$t_{(MDH)}$	MD hold time	15		ns
$t_{(MDS)}$	MD setup time	15		ns

⁽¹⁾ MC rising edge for LSB to MS rising edge.

Figure 29. PCM1850 Control Interface Timing

I²C SERIAL CONTROL PORT FOR MODE CONTROL (PCM1851)

The user-programmable built-in function of the PCM1851 can be controlled through the I²C-format serial control port, SDA (pin 32) and SCL (pin 31). The PCM1851 supports the I²C serial bus and the data transmission protocol for standard mode as a slave device. This protocol is explained in the I²C specification 2.0.

Slave Address

MSB						LSB	
1	0	0	1	0	1	ADR	R/nW

The PCM1851 has 7 bits for its own slave address. The first six bits (MSBs) of the slave address are factory preset to 100101. The last bit of the address byte is the device select bit, which can be user-defined by the ADR pin (pin 30). A maximum of two PCM1851s can be connected on the same bus at one time. Each PCM1851 responds when it receives its own slave address.

TIMING DIAGRAM

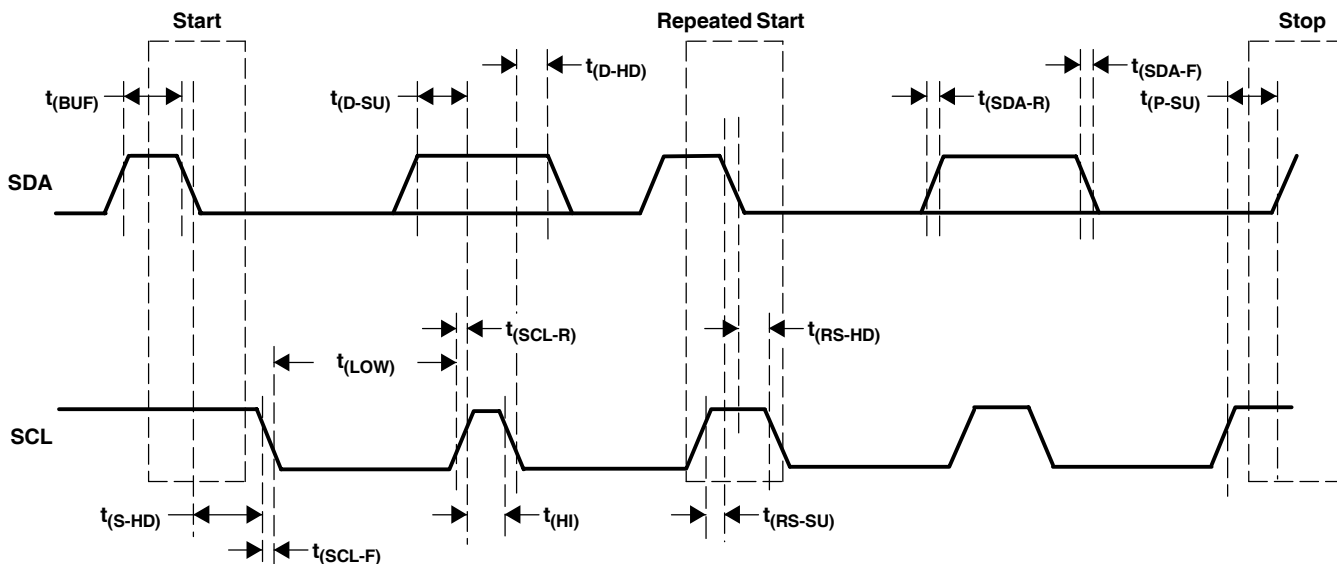

SYMBOL	PARAMETER	MIN	MAX	UNIT
$f_{(SCL)}$	SCL clock frequency		100	kHz
$t_{(BUF)}$	Bus free time between STOP and START condition	4.7		μ s
$t_{(LOW)}$	Low period of the SCL clock	4.7		μ s
$t_{(HI)}$	High period of the SCL clock	4		μ s
$t_{(RS-SU)}$	Setup time for START/repeated START condition	4.7		μ s
$t_{(S-HD)}$ $t_{(RS-HD)}$	Hold time for START/repeated START condition	4		μ s
$t_{(D-SU)}$	Data setup time	250		ns
$t_{(D-HD)}$	Data hold time	0	900	ns
$t_{(SCL-R)}$	Rise time of SCL signal	$20 + 0.1C_B$	1000	ns
$t_{(SCL-F)}$	Fall time of SCL signal	$20 + 0.1C_B$	1000	ns
$t_{(SDA-R)}$	Rise time of SDA signal	$20 + 0.1C_B$	1000	ns
$t_{(SDA-F)}$	Fall time of SDA signal	$20 + 0.1C_B$	1000	ns
$t_{(P-SU)}$	Setup time for STOP condition	4		μ s
C_B	Capacitive load for SDA and SCL line		400	pF
V_{NH}	Noise margin at HIGH level for each connected device (including hysteresis)	$0.2 V_{DD}$		V

Figure 32. PCM1851 Control Interface Timing Requirements

MODE CONTROL REGISTERS

User-Programmable Mode Control Functions

The PCM1850/1851 has several user-programmable functions which are accessed via control registers. The registers are programmed using the serial control port which is discussed in the *SPI Serial Control Port for Mode Control (PCM1850)* and *I²C Serial Control Port for Mode Control (PCM1851)* sections of this data sheet. Table 6 lists the available mode control functions, along with their reset default conditions and associated register index.

Register Map

The mode control register map is shown in Table 7. Each register includes an index (or address) indicated by the IDX[6:0] bits B[14:8].

Table 6. User-Programmable Mode Control Functions

FUNCTION	RESET DEFAULT	REGISTER	BIT(S)
Mode register reset	Normal operation	31	MRST
PGA gain control	-11 dB	31	PG[5:0]
Multiplexer input channel control	Channel 1	32	CH[2:0]
HPF bypass control	HPF enable	33	BYP
System reset	Normal operation	33	SRST
Audio interface mode control	Slave	33	MD[1:0]
Audio interface format control	I ² S	33	FMT[2:0]

Table 7. Mode Control Register Map

HEX	B15	B14	B13	B12	B11	B10	B9	B8	B7	B6	B5	B4	B3	B2	B1	B0
Register 31	0	0	1	1	0	0	0	1	RSV	MRST	PG5	PG4	PG3	PG2	PG1	PG0
Register 32	0	0	1	1	0	0	1	0	RSV	RSV	RSV	RSV	RSV	CH2	CH1	CH0
Register 33	0	0	1	1	0	0	1	1	BYP	SRST	RSV	MD1	MD0	FMT2	FMT1	FMT0

NOTE: RSV bit must be always written as 0. No values can be written in address 30h.

TYPICAL CIRCUIT CONNECTION DIAGRAM

The following figure illustrates a typical circuit connection diagram for six stereo inputs and an analog monitor.

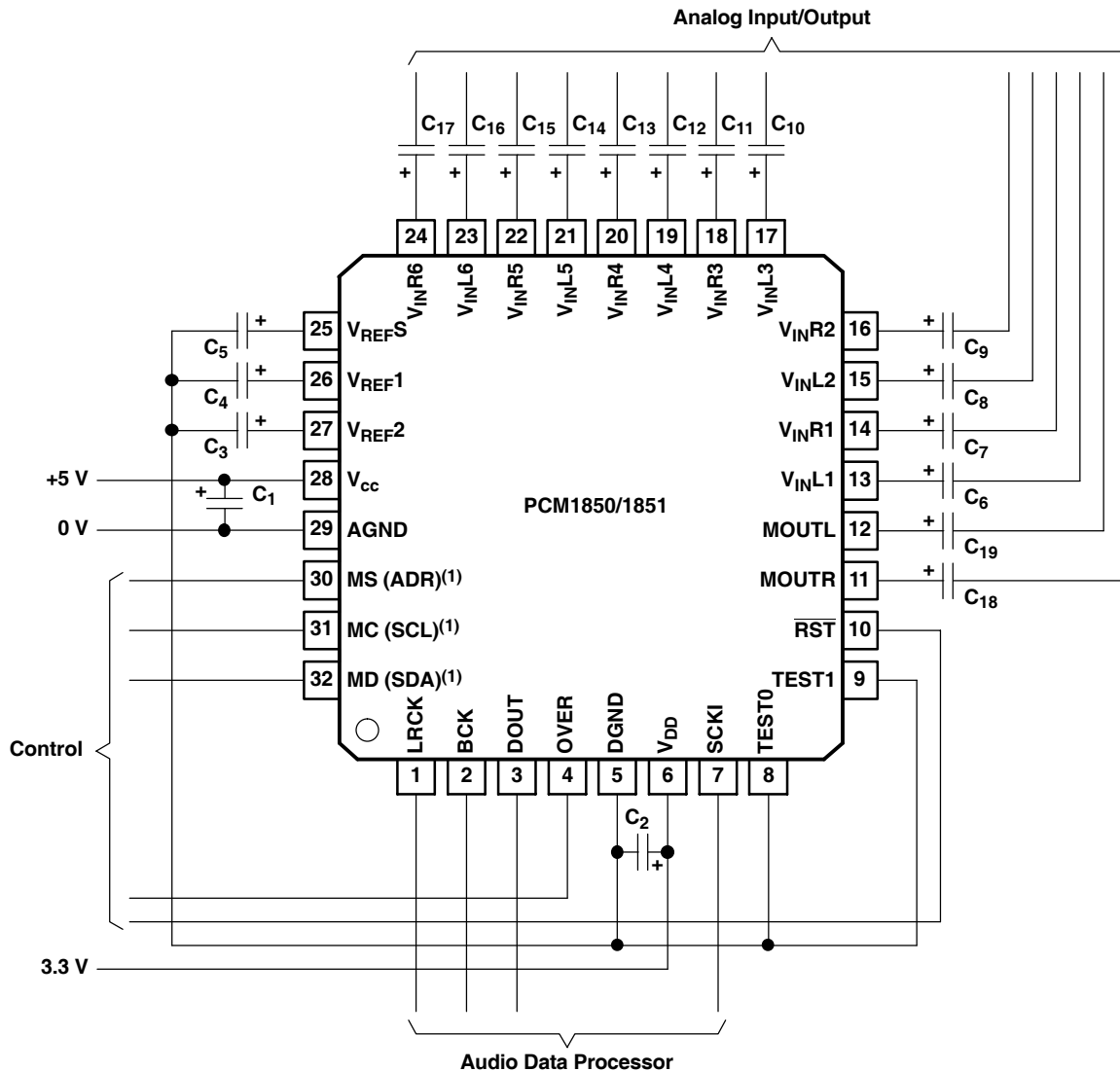

(1) PCM1850 (PCM1851)

NOTE: C₁, C₂: 0.1- μ F ceramic and 10- μ F electrolytic capacitors are recommended, depending on layout and power supply.

C₃, C₄, C₅: 0.1- μ F ceramic and 10- μ F electrolytic capacitors are recommended.

C₆ – C₁₇: A 0.33- μ F capacitor gives a 2.9-Hz ($\tau = 0.33 \mu\text{F} \times 169 \text{ k}\Omega$) typical cutoff frequency at the HPF input in normal operation, and it requires power-on settling time with a 56-ms time constant in the power-on initialization period. Cutoff frequency and time constant depend on PGA gain. Cutoff frequency varies from 2.4 Hz to 8.5 Hz for 0.33 μ F. Dc-coupled input is inhibited for the analog input, V_{INL}[1:6] and V_{INR}[1:6].

C₁₈–C₁₉: A 2.2- μ F capacitor with a 10-k Ω load gives a 7.2-Hz cutoff frequency.

BOARD DESIGN AND LAYOUT CONSIDERATIONS

V_{CC}, V_{DD} Pins

The digital and analog power supply lines to the PCM1850/1851 must be bypassed to the corresponding ground pins with 0.1- μ F ceramic and 10- μ F electrolytic capacitors as close to the pins as possible to maximize the dynamic performance of the ADC.

AGND, DGND Pins

To maximize the dynamic performance of the PCM1850/1851, the analog and digital grounds are not connected internally. These grounds must have low impedance to avoid digital noise feeding back into the analog ground. Therefore, they should be connected directly to each other under the parts to reduce the potential of a noise problem.

V_{INL}[1:6], V_{INR}[1:6] Pins

A 0.33- μ F capacitor is recommended as the ac-coupling capacitor, which gives a 2.4- to 8.5-Hz cutoff frequency. If higher full-scale input voltage is required, it can be adjusted by adding only one series resistor to each V_{INxx} pin, but a signal source resistance less than 1 k Ω is recommended for these pins in order to keep accuracy of the gain control command and to maintain crosstalk performance.

MOU_{TL}, MOU_{TR} Pins

An ac-coupled light load is recommended; a 2.2- μ F capacitor with a 10-k Ω load gives a 7.2-Hz cutoff frequency.

V_{REF1}, V_{REF2}, V_{REFS} Pins

Between V_{REF1} and AGND, V_{REF2} and AGND, and V_{REFS} and AGND, 0.1- μ F ceramic and 10- μ F electrolytic capacitors are recommended to ensure low source impedance of the ADC references. These capacitors should be located as close as possible to the V_{REF1}, V_{REF2}, and V_{REFS} pins to reduce dynamic errors on the ADC references. The differential voltage between V_{REF2} and AGND sets the analog input full-scale range.

BCK and LRCK Pins (in Master Mode), DOUT Pin

These pins have enough load driving capability. However, if the output line is long, locating a buffer near the PCM1850/1851 and minimizing load capacitance is recommended in order to minimize the digital-analog crosstalk and maximize the dynamic performance of the ADC.

System Clock

Because the PCM1850/1851 operates based on a system clock, the quality of the system clock can influence dynamic performance. Therefore, it is recommended to consider the system clock duty, jitter, and the time difference between the system clock transition and the BCK or LRCK transition in slave mode.

PJT (S-PQFP-N32)

PLASTIC QUAD FLATPACK

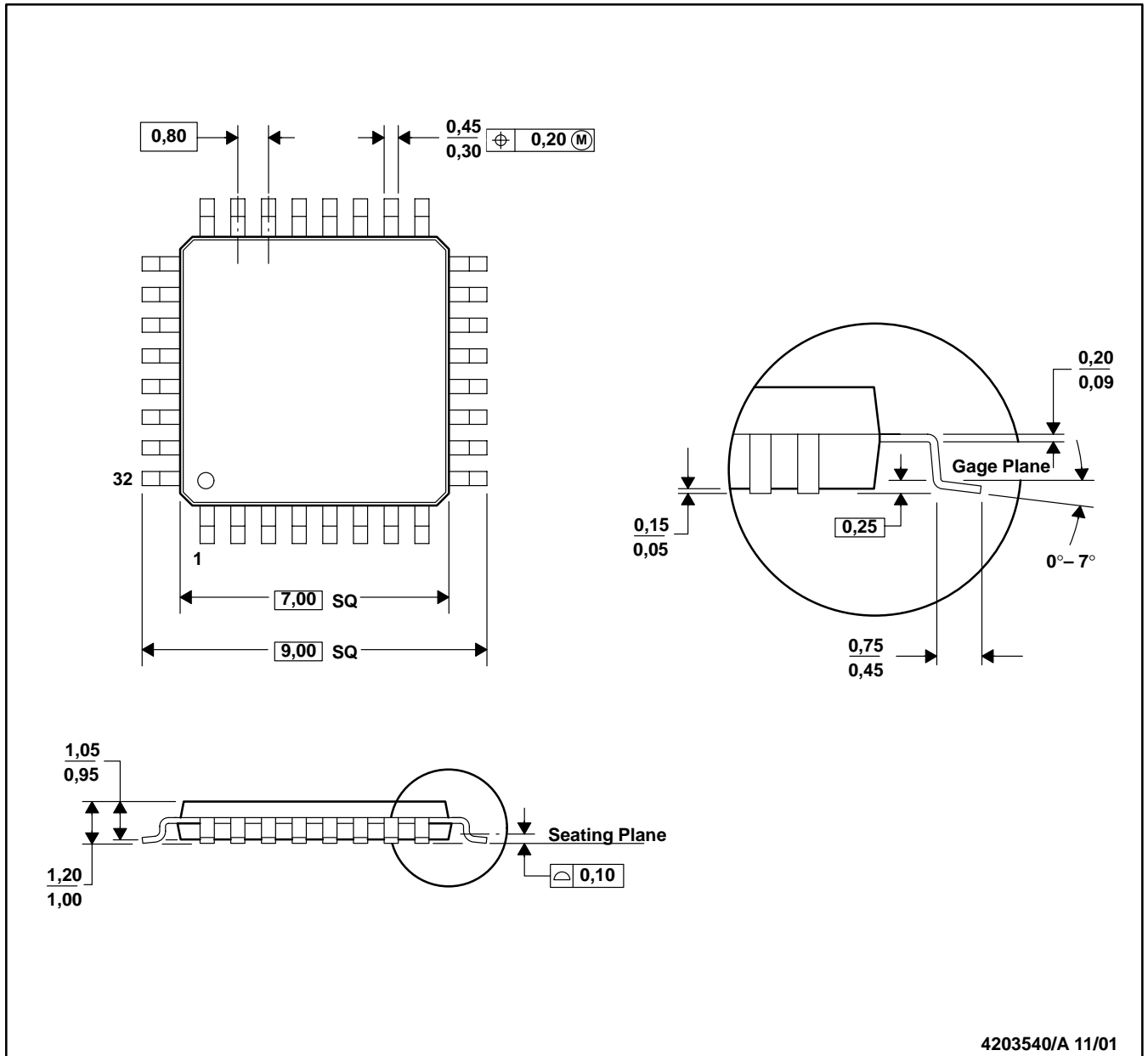

- NOTES: A. All linear dimensions are in millimeters.
 B. This drawing is subject to change without notice.
 C. Falls within JEDEC MS-026

IMPORTANT NOTICE

Texas Instruments Incorporated and its subsidiaries (TI) reserve the right to make corrections, modifications, enhancements, improvements, and other changes to its products and services at any time and to discontinue any product or service without notice. Customers should obtain the latest relevant information before placing orders and should verify that such information is current and complete. All products are sold subject to TI's terms and conditions of sale supplied at the time of order acknowledgment.

TI warrants performance of its hardware products to the specifications applicable at the time of sale in accordance with TI's standard warranty. Testing and other quality control techniques are used to the extent TI deems necessary to support this warranty. Except where mandated by government requirements, testing of all parameters of each product is not necessarily performed.

TI assumes no liability for applications assistance or customer product design. Customers are responsible for their products and applications using TI components. To minimize the risks associated with customer products and applications, customers should provide adequate design and operating safeguards.

TI does not warrant or represent that any license, either express or implied, is granted under any TI patent right, copyright, mask work right, or other TI intellectual property right relating to any combination, machine, or process in which TI products or services are used. Information published by TI regarding third-party products or services does not constitute a license from TI to use such products or services or a warranty or endorsement thereof. Use of such information may require a license from a third party under the patents or other intellectual property of the third party, or a license from TI under the patents or other intellectual property of TI.

Reproduction of information in TI data books or data sheets is permissible only if reproduction is without alteration and is accompanied by all associated warranties, conditions, limitations, and notices. Reproduction of this information with alteration is an unfair and deceptive business practice. TI is not responsible or liable for such altered documentation.

Resale of TI products or services with statements different from or beyond the parameters stated by TI for that product or service voids all express and any implied warranties for the associated TI product or service and is an unfair and deceptive business practice. TI is not responsible or liable for any such statements.

Following are URLs where you can obtain information on other Texas Instruments products and application solutions:

Products		Applications	
Amplifiers	amplifier.ti.com	Audio	www.ti.com/audio
Data Converters	dataconverter.ti.com	Automotive	www.ti.com/automotive
DSP	dsp.ti.com	Broadband	www.ti.com/broadband
Interface	interface.ti.com	Digital Control	www.ti.com/digitalcontrol
Logic	logic.ti.com	Military	www.ti.com/military
Power Mgmt	power.ti.com	Optical Networking	www.ti.com/opticalnetwork
Microcontrollers	microcontroller.ti.com	Security	www.ti.com/security
		Telephony	www.ti.com/telephony
		Video & Imaging	www.ti.com/video
		Wireless	www.ti.com/wireless

Mailing Address: Texas Instruments
Post Office Box 655303 Dallas, Texas 75265