

TABLE 1

MOLEX P/N	ENG. NO.	CABLE LENGTH (mm)	LED
1202470005	BEBA01P-FBW-003	300	YES
1202470006	BEBA01P-FBW-05	5000	YES
1202470007	BEBA01P-FBW-10	10000	YES
1202470008	BEBA01P-FBW-15	15000	YES
1202470009	BEBA01P-FBW-20	20000	YES
1202470037	BEBA010-FBW-05	5000	NO
1202470038	BEBA010-FBW-10	10000	NO
1202470039	BEBA010-FBW-15	15000	NO

TABLE 2

ITEM	COMPONENT	MATERIAL	FINISH
1	INSERT	TPU	BLACK
2	CONTACT SOCKET	COPPER ALLOY	GOLD OVER NICKEL
3	O-RING	VITON	RED
4	RECEPTACLE SHELL	BRASS	NICKEL PLATED
5	HOUSING	PBT	BLACK
6	CABLE	TPU	BLACK
7	LABEL	ABS	WHITE
8	LABLE ADHESIVE	PE	WHITE
9	CABLE PLATE	PBT	BLACK
10	LED	NO LED = PA WITH LED = PA	BLACK TRANSPARENT
11	RESIN	EPOXY	TRANSPARENT

SCALE 2:1

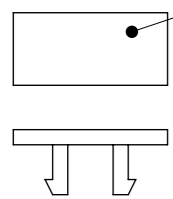

LABEL
11x packed in a bag.

GENERAL CHARACTERISTICS:

NOMINAL VOLTAGE: 24 V DC
 RATED CURRENT: 2 A PER PORT / 6 A MAX: TOTAL
 IP DEGREE OF PROTECTION: IP 68
 TEMPERATURE RANGE: -25°C to + 85°C

SCALE 1:2

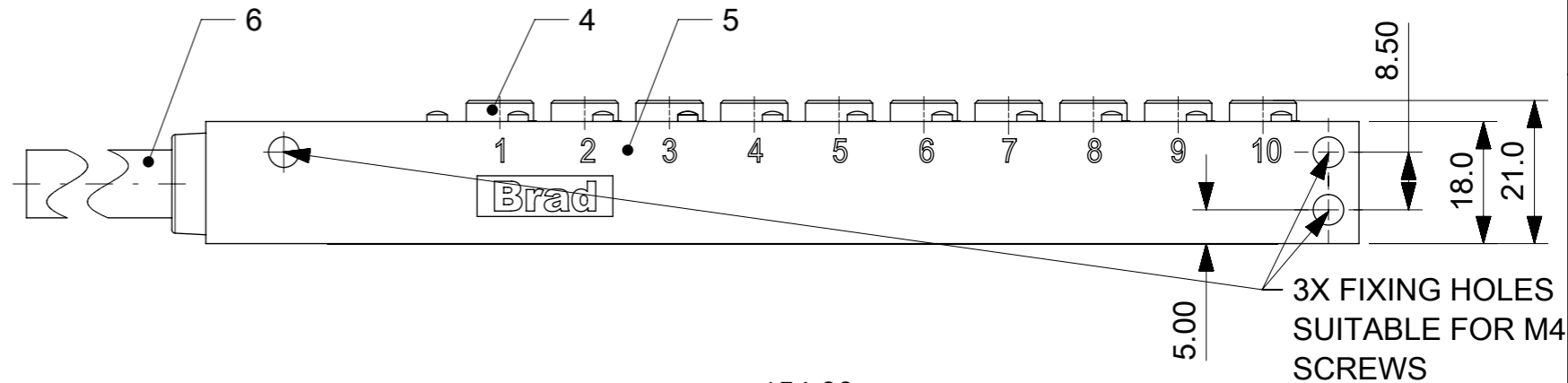
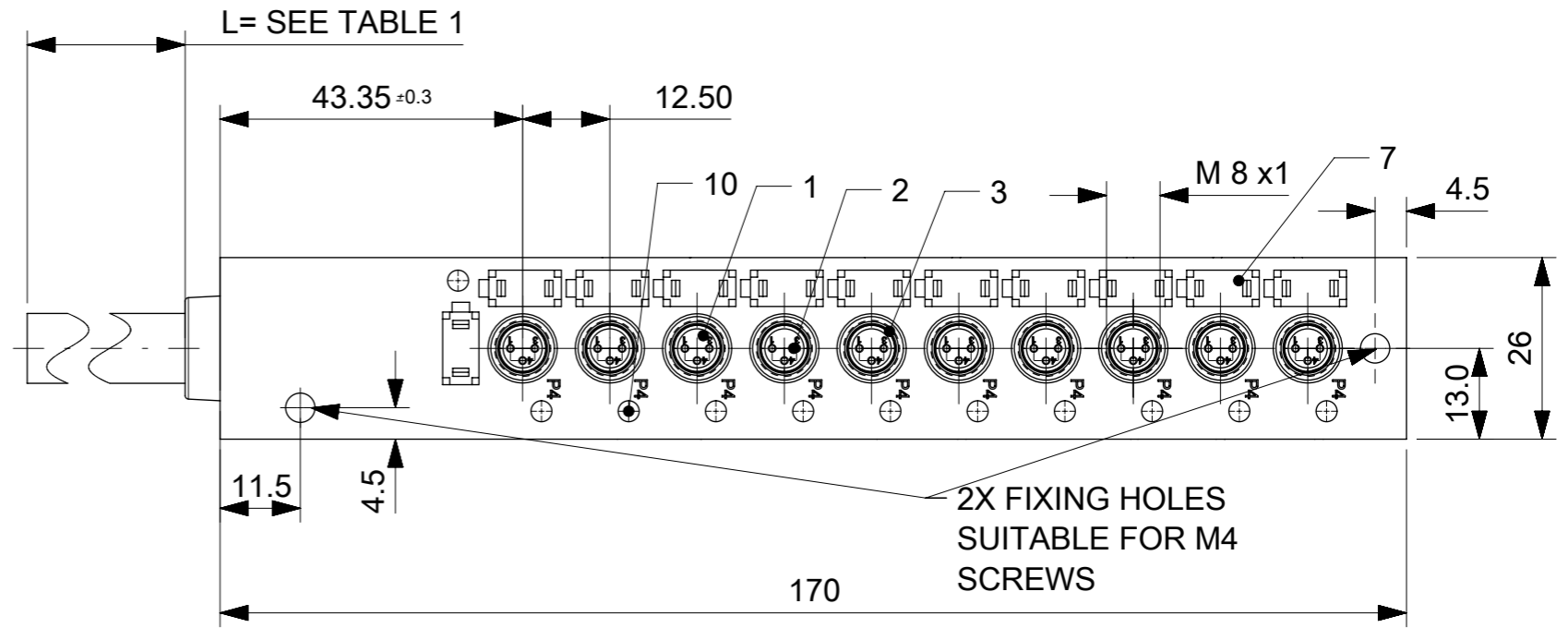
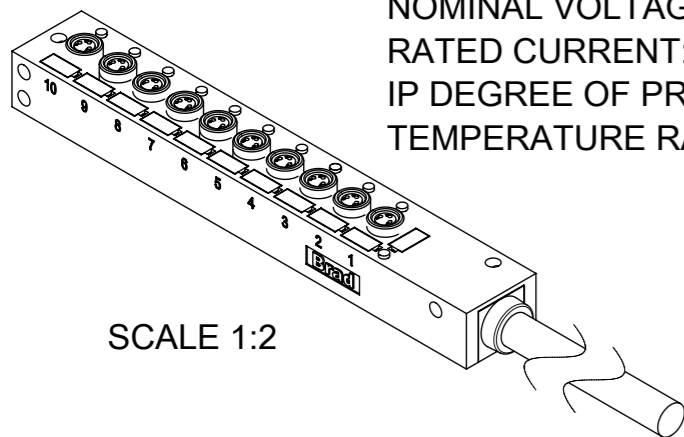

Ø8.8 ±0.25

THIS DRAWING CONTAINS INFORMATION THAT IS PROPRIETARY TO MOLEX INCORPORATED AND SHOULD NOT BE USED WITHOUT WRITTEN PERMISSION

EC DESCRIPTION EC NO: 112816 DRWN: ULETTENMEIER 2016/09/26 CHK'D: APPR: RSILLER 2017/01/26	QUALITY SYMBOLS	GENERAL TOLERANCES (UNLESS SPECIFIED)	DIMENSION UNITS	SCALE	
	▽ = 0 ▽ = 0 ▽ = 0 ▽ = 0 ▽ = 0 ▽ = 0 ▽ = 0 ▽ = 0	ANGULAR TOL ± ° 4 PLACES ± 3 PLACES ± 2 PLACES ± 0.2 1 PLACE ± 0.3 0 PLACES ± 0.5	MM	1:1	
	DRWN BY: ULETTENMEIER DATE: 2015/01/20	APPR BY: RSILLER DATE: 2015/04/22	PRODUCT CUSTOMER DRAWING		
	DRAWING SIZE: A3 THIRD ANGLE PROJECTION	SERIES: 120247 MATERIAL NUMBER: SEE TABLE 1 CUSTOMER: GENERAL MARKET			
EC NO: 112816 DRWN: ULETTENMEIER 2016/09/26 CHK'D: APPR: RSILLER 2017/01/26	EC NO: 112816 DRWN: ULETTENMEIER 2016/09/26 CHK'D: APPR: RSILLER 2017/01/26	DOCUMENT NUMBER: 1202470005 DOC TYPE: PSD DOC PART: 000 SHEET NUMBER: 1 OF 2			

Wiring Diagram PNP Single

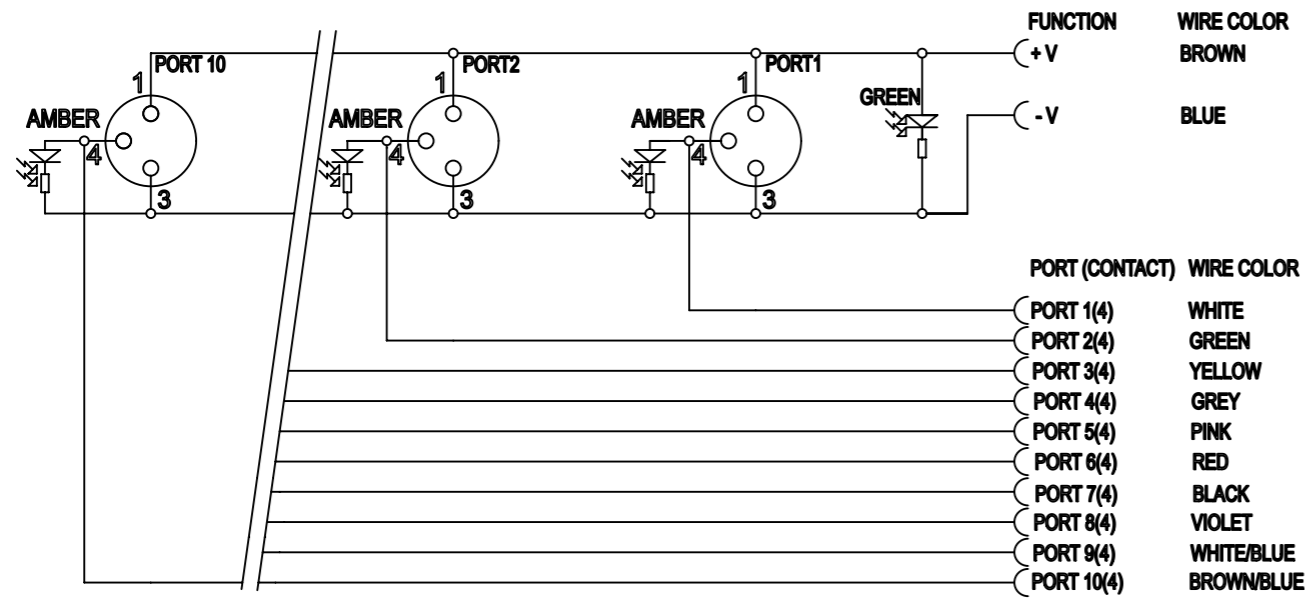

Wiring Diagram NPN Single

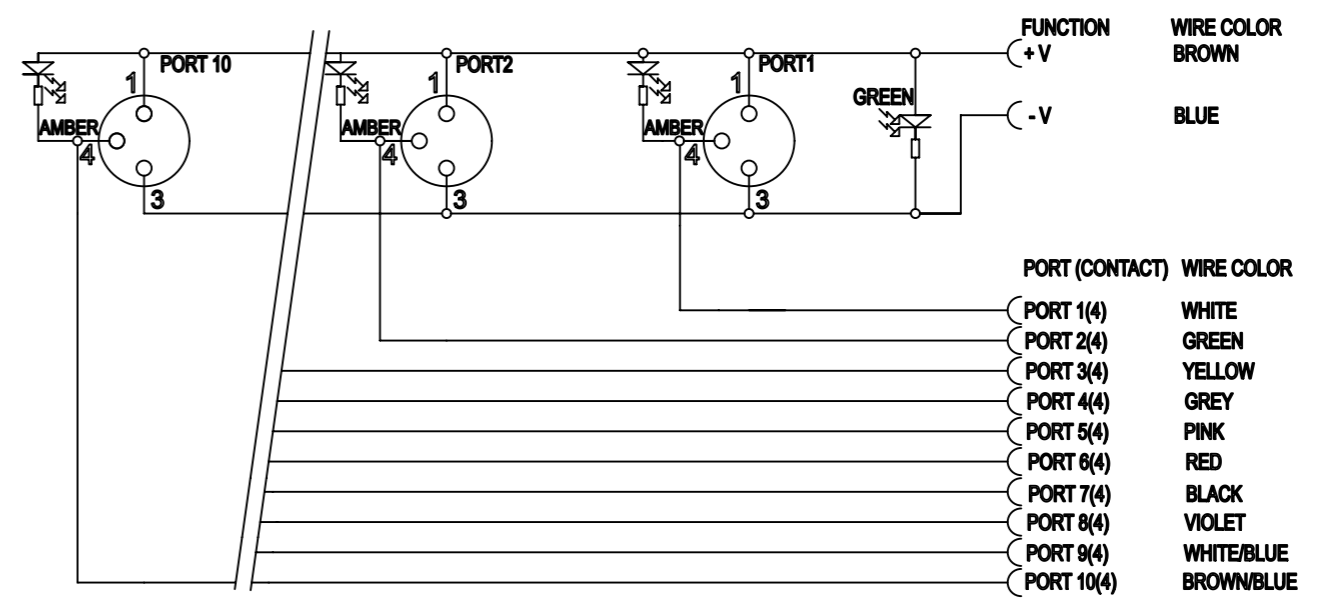

Wiring Diagram NON LED Single

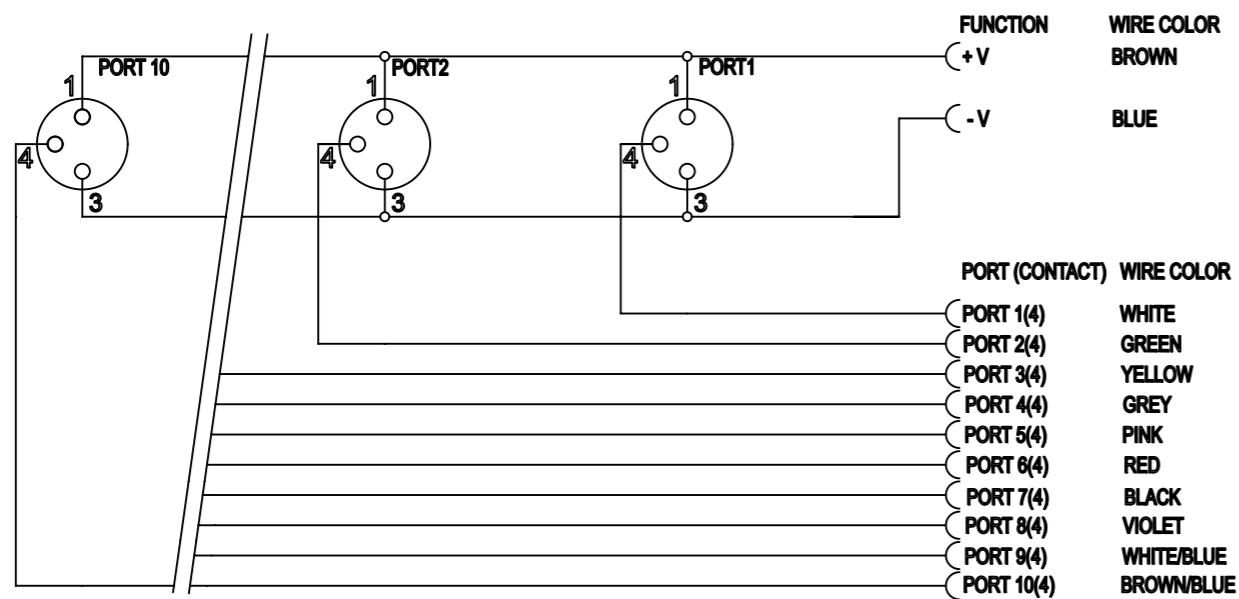

THIS DRAWING CONTAINS INFORMATION THAT IS PROPRIETARY TO MOLEX INCORPORATED AND SHOULD NOT BE USED WITHOUT WRITTEN PERMISSION

EC DESCRIPTION EC NO: 112816 DRWN: ULETTENMEIER 2016/09/26 CHK'D: APPR: RSILLER 2017/01/26	QUALITY SYMBOLS ∇ = 0 ∇ = 0 ∇ = 0 ▼ = 0 ∇ = 0 ☒ = 0 ■ = 0 ∇ = 0	GENERAL TOLERANCES (UNLESS SPECIFIED) ANGULAR TOL ± ° 4 PLACES ± 3 PLACES ± 2 PLACES ± 0.2 1 PLACE ± 0.3 0 PLACES ± 0.5 DRAFT WHERE APPLICABLE MUST REMAIN WITHIN DIMENSIONS	DIMENSION UNITS MM SCALE 1:1 DRWN BY ULETTENMEIER DATE 2015/01/20 CHK'D BY DATE APPR BY RSILLER DATE 2015/04/22 DRAWING SIZE A3 THIRD ANGLE PROJECTION	molex MPIS M8 PNP NPN NOS 3P 10PT BK XM SINGLE PRODUCT CUSTOMER DRAWING			
			SERIES	MATERIAL NUMBER	CUSTOMER		
			120247	SEE TABLE 1		GENERAL MARKET	
	DOCUMENT NUMBER		DOC TYPE		DOC PART	SHEET NUMBER	
1202470005		PSD		000	2 OF 2		