

TMP6EVM User's Guide

The TMP6EVM is a prototype evaluation module (EVM) designed to evaluate the silicon-based TMP6131 thermistor. The TMP6xxx is a family of positive temperature coefficient (PTC) thermistors, which the resistance increases with temperature. This user's guide describes the characteristics, operation, and use of the TMP6EVM evaluation board. Throughout this document, the terms evaluation board, evaluation module, and EVM are synonymous with the TMP6EVM.

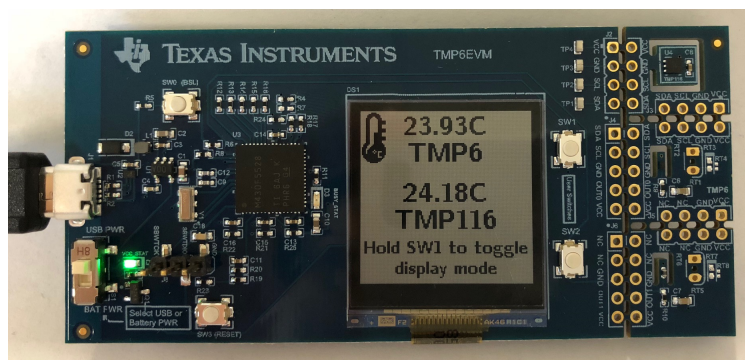

Figure 1. TMP6EVM Top View

NOTE: The EVM's SPDT power switch (component *S1*) is located next to the green *VCC_STAT* LED. Use the *S1* switch to change between the USB and battery power modes. The switch position closest to the micro USB receptacle is the USB power mode and the switch position closest to the corner is the battery power mode. Refer to [Figure 1](#).

NOTE: Important disclaimer: In the standalone demo mode (without GUI), the system is calibrated to TMP116 on power reset to remove any initial temperature offset between the TMP6 and TMP116. In the data logging mode with the GUI, no calibration is applied.



Figure 2. TMP6EVM Bottom View

Contents

1	Overview	3
2	EVM Hardware	6
3	EVM Software Setup.....	12
4	EVM Software Overview	16
5	EVM Documentation	19

List of Figures

1	TMP6EVM Top View	1
2	TMP6EVM Bottom View	1
3	Disclaimer Page After Powering Up in Standalone Mode.....	3
4	Quick User's Guide Page.....	4
5	EVM LCD Display Indicating Data Logging Mode.....	4
6	Hardware Included With the EVM Kit	5
7	EVM Block Diagram	6
8	USB Device Driver Installation	6
9	Daughtercard Required Connections for Using All Three Channels.....	7
10	Motherboard Required Connections for Using All Three Channels.....	8
11	EVM 3D Top View	9
12	EVM 3D Bottom View	9
13	Primary EVM Display Mode.....	11
14	Secondary EVM Display Mode	11
15	TMP6 EVM GUI Installation Wizard	12
16	TMP6 EVM GUI License Agreement	13
17	TMP6 EVM GUI Installation Folder Selection	13
18	TMP6 EVM GUI Installation.....	14
19	TMP6 EVM Installation Finish	14
20	Launching the EVM GUI	15
21	Home Page	16
22	Collateral Page	17
23	Data Capture.....	18
24	EVM Schematic	19
25	Top Layers	20
26	Top Signal Layer	21
27	Ground Layer	22
28	Power Layer	23
29	Bottom Signal Layer	24
30	Bottom Layers	25

List of Tables

1	EVM Kit Contents.....	5
2	Recommended Operating Conditions.....	7
3	EVM Bill of Material	26

Trademarks

Windows is a registered trademark of Microsoft Corporation.
All other trademarks are the property of their respective owners.

1 Overview

The TMP6EVM is an evaluation module designed to evaluate the TMP6131 thermistor. The EVM features the TMP116 high-accuracy local digital temperature sensor (Channel 0), TMP6131 PTC thermistor (Ch1), and an optional analog channel (Ch2). The EVM can be powered either through a micro USB cable or with a CR2032 3-V coin cell battery. In standalone mode (when powered with a 5-V USB wall plug or coin cell battery), the EVM requires no additional hardware or software to begin evaluation. The LCD provides the readout. In data logging mode (when connected to a computer USB port), the user must open up the graphical user interface (GUI) to visualize the readouts. When powering up in standalone mode, the user is presented with a disclaimer the user must accept to proceed with evaluation (as shown in [Figure 3](#)). Following the disclaimer, the user is presented with a quick user's guide [Figure 4](#). When the user has read the quick user's guide, the user can begin evaluation. The temperature data are updated to the LCD at approximately 2 Hz. The EVM hosts a MSP430F5528 microcontroller, which is used to interface with both the digital and analog devices. The sensor section of the PCB may be separated from the main PCB to support prototyping in a system where the sensor is remotely placed away from the host controller.

NOTE: Windows will install the necessary drivers the first time the EVM is connected to the computer USB port. After the driver installation, the user must select the RESET button (SW3) to switch to the data logging mode. The LCD will display a TI logo as shown in [Figure 5](#), which indicates that the EVM is in data logging mode and that the user must open the GUI.

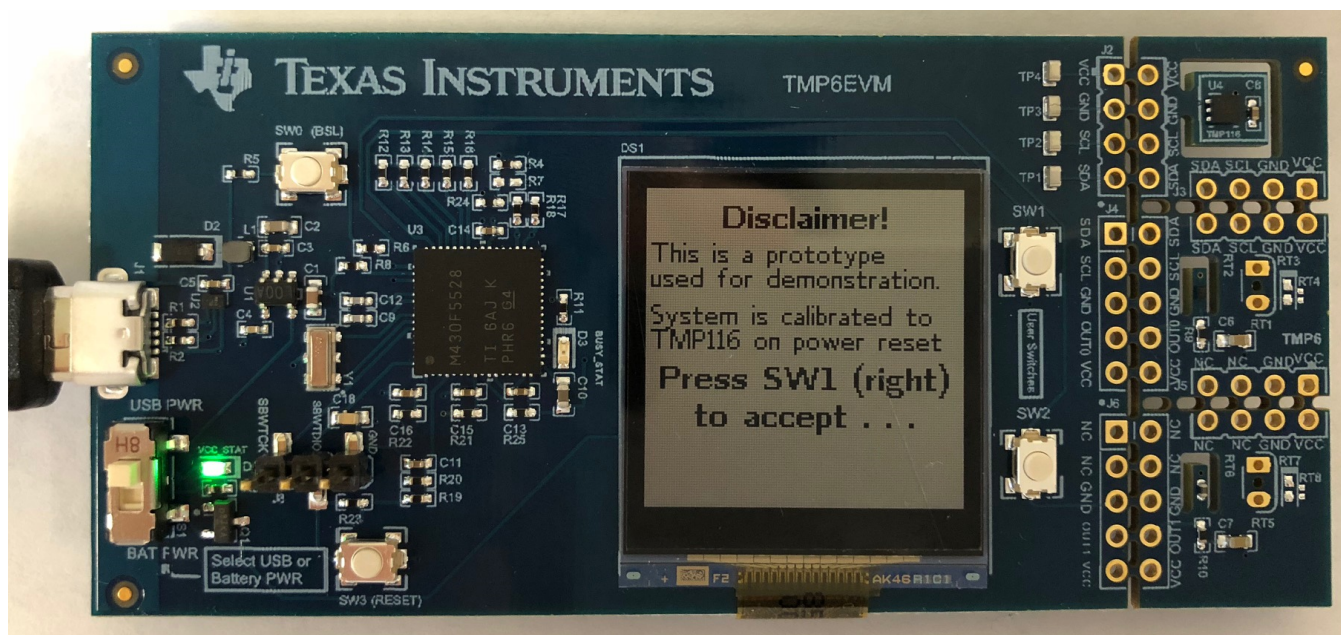

Figure 3. Disclaimer Page After Powering Up in Standalone Mode

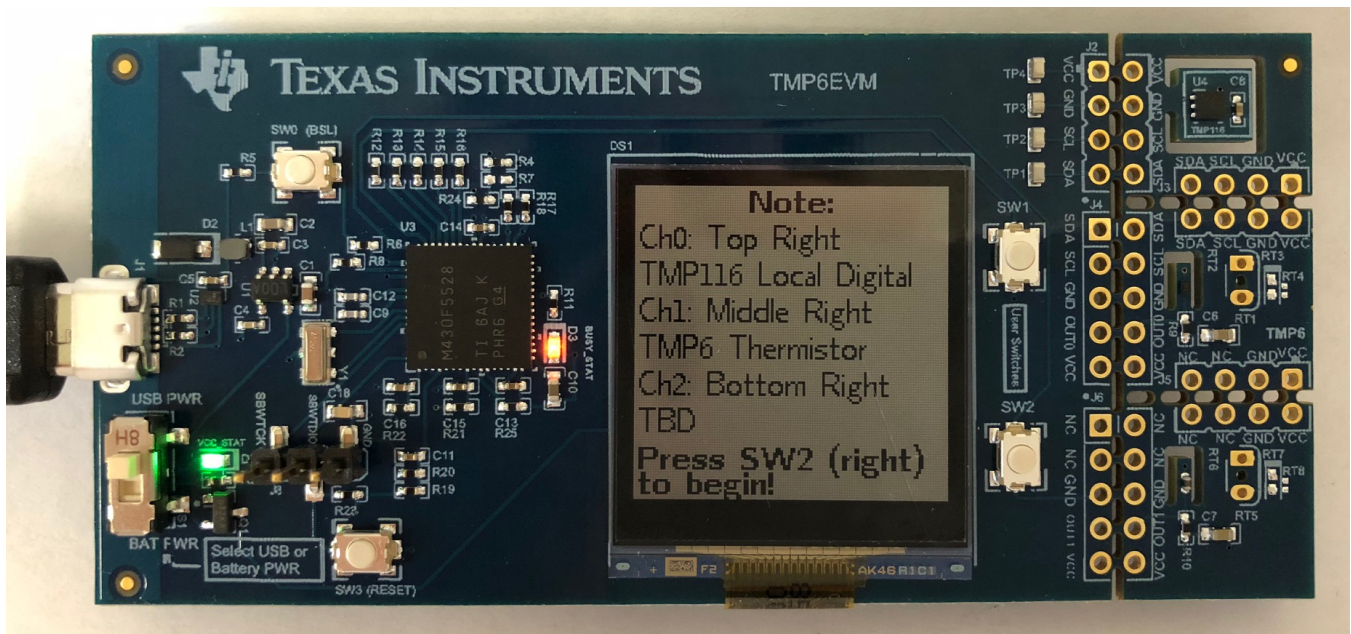

Figure 4. Quick User's Guide Page

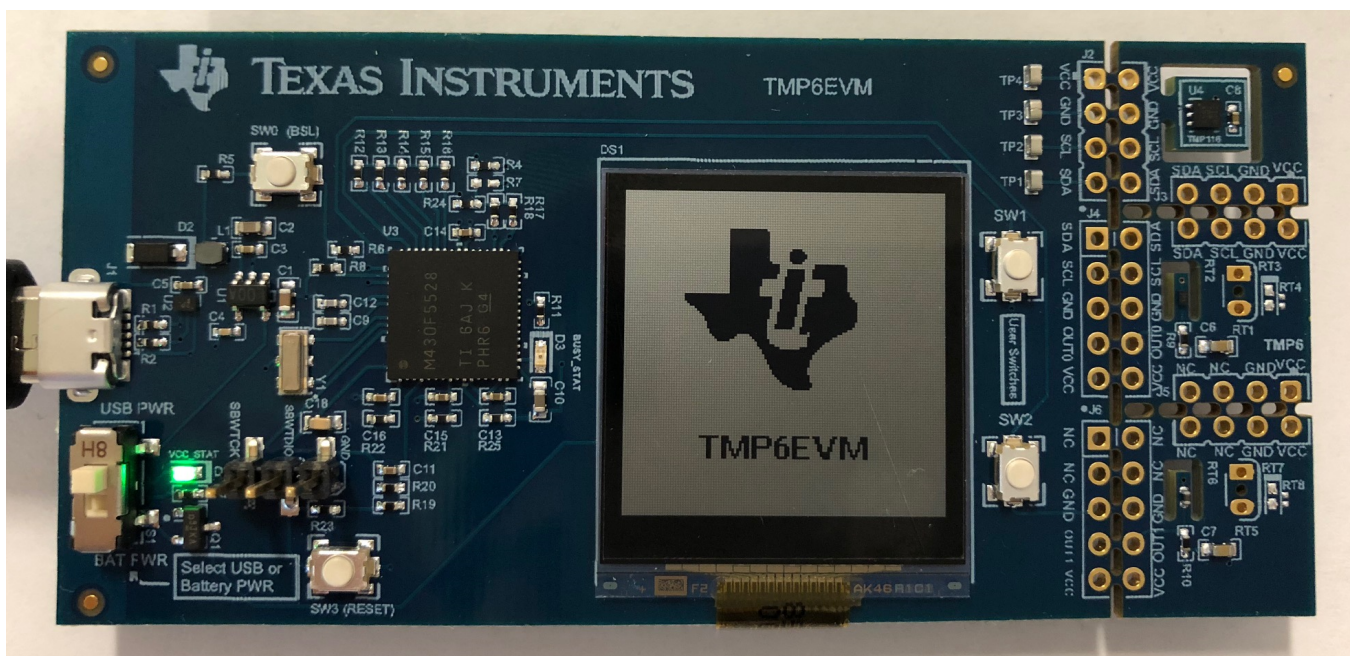

Figure 5. EVM LCD Display Indicating Data Logging Mode

1.1 EVM Kit Contents

Table 1 lists the contents of the EVM kit, and Figure 6 shows all of the included hardware. Refer to Section 2.3 for the recommended operation conditions. Contact the nearest Texas Instruments Product Information Center if any component is missing.

Table 1. EVM Kit Contents

ITEM	QUANTITY
TMP6EVM	1
USB A Male to USB B Micro Male Cable	1



Figure 6. Hardware Included With the EVM Kit

1.2 REACH

CAUTION

This EVM includes a crystal component (CSTCR4M00G15L99-R0) that contains >0.1% of Lead Titanium Oxide CAS# 12626-81-2 listed in EU REACH as a Substance of Very High Concern. For more information, contact the component manufacturer.

2 EVM Hardware

This section discusses the EVM hardware design.

2.1 EVM Theory of Operation

The EVM consists of two sections that can be separated by breaking the PCB at the perforations. The red dashed lines in [Figure 7](#) represent the breakable connections on the PCB. The left section contains a standard USB Type B micro receptor, a coin cell receptor, an ESD protection block, a 3.0-V LDO, a SPDT switch, a [MSP430](#) microcontroller with an integrated 12-bit SAR Analog-to-Digital Converter (ADC), two LED indicators, a battery monitor circuit, and a 128x128 LCD display. The right section features the TMP116 digital temperature sensor, the TMP6131 thermistor divider network, and an optional thermistor network.

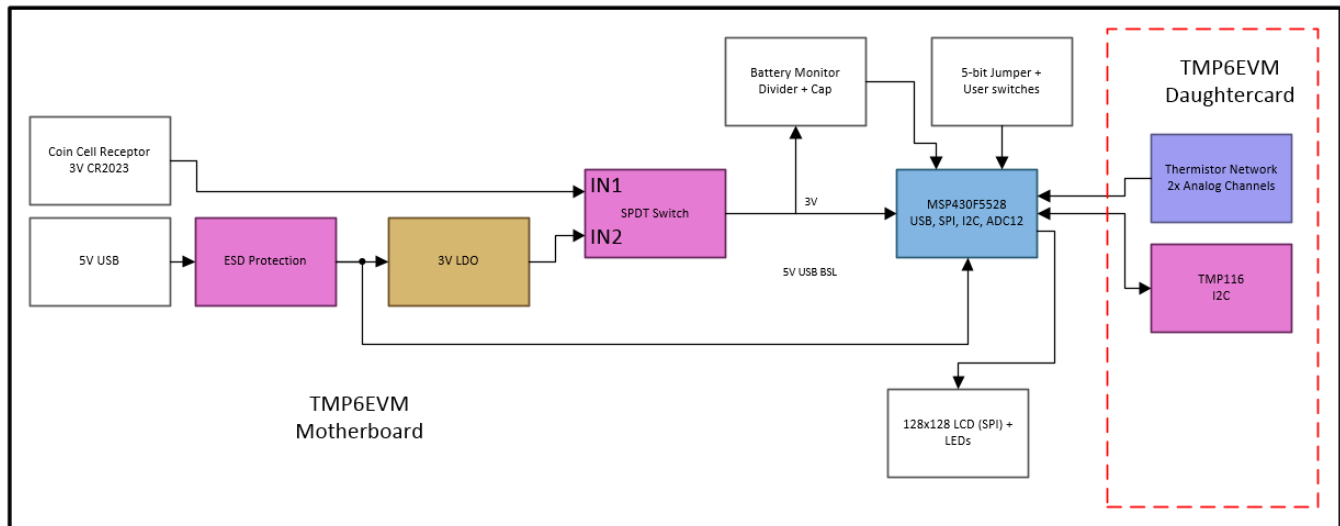

Figure 7. EVM Block Diagram

2.2 Connecting the EVM to a Computer

[Figure 8](#) shows the typical response when connecting the EVM board to a PC USB port for the first time. Typically, the computer responds with a *Found New Hardware, USB device* pop-up dialog. The pop-up window then typically changes to *Found New Hardware, USB Human Interface Device*. This pop-up indicates that the device is ready to be used. The EVM uses the human interface device drivers that are part of the Microsoft Windows® operating system.

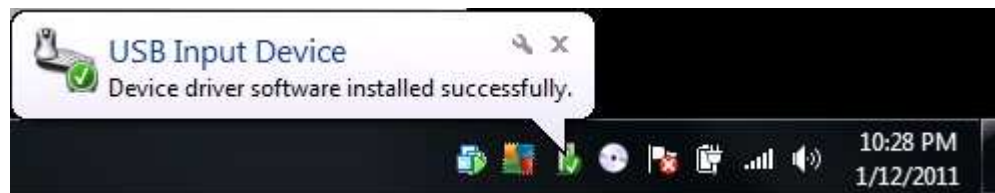

Figure 8. USB Device Driver Installation

In some cases, the Windows *Add Hardware Wizard* is shown. If this prompt occurs, allow the system device manager to install the human interface drivers by clicking *Yes* when requested to install drivers. Windows confirms installation of the drivers with the message shown in [Figure 8](#).

2.3 Operating Conditions

Table 2. Recommended Operating Conditions

PARAMETER	TEST CONDITIONS	MIN	NOM	MAX	UNIT
Operating free-air temperature	Motherboard	-20	25	70	°C
Operating free-air temperature	USB Extension Cable	NA	25	80	°C
Operating free-air temperature	Daughtercard	-40	25	125	°C

The EVM motherboard can only operate up to 70°C due to the LCD display's limitation. To evaluate the TMP6131 device at its maximum specified operating temperature of 125°C, the user must break off the breakout section of the EVM. Use the unpopulated pin hole header J4 and a cable (not included in the kit) to thermally isolate the two EVM sections. The J4 header has five pins (SDA, SCL, GND, OUT0, and VCC), which is enough to support both the TMP116 and TMP6 devices. This sharing of VCC and GND between TMP116 and the TMP6 network reduces the total wire count in the breakout mode. However, to support all three channels (the TMP116, TMP6, and an optional thermistor channel) an additional connection is needed (OUT1 from J6) as shown in [Figure 9](#) and [Figure 10](#). Note that the pins on J5 are normally connected. In contrast, the J3 pins are normally open, which is why J3 requires the user to manually short the pins during breakout mode.

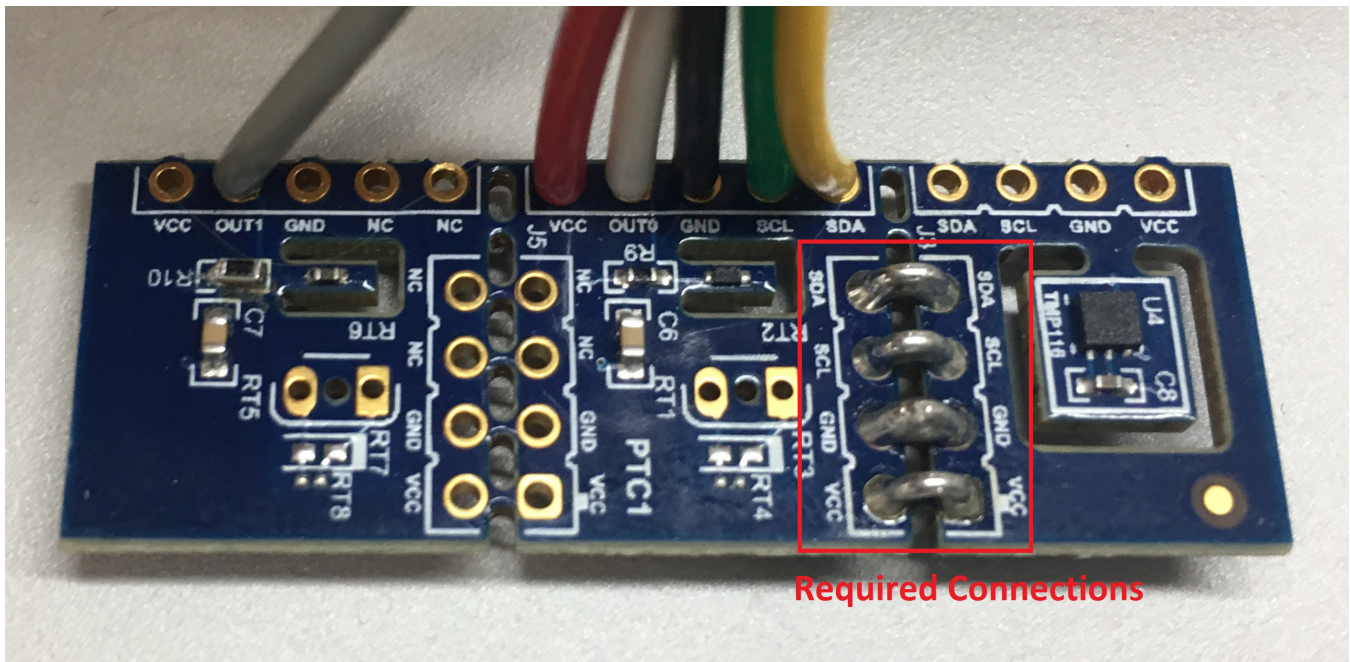

Figure 9. Daughtercard Required Connections for Using All Three Channels

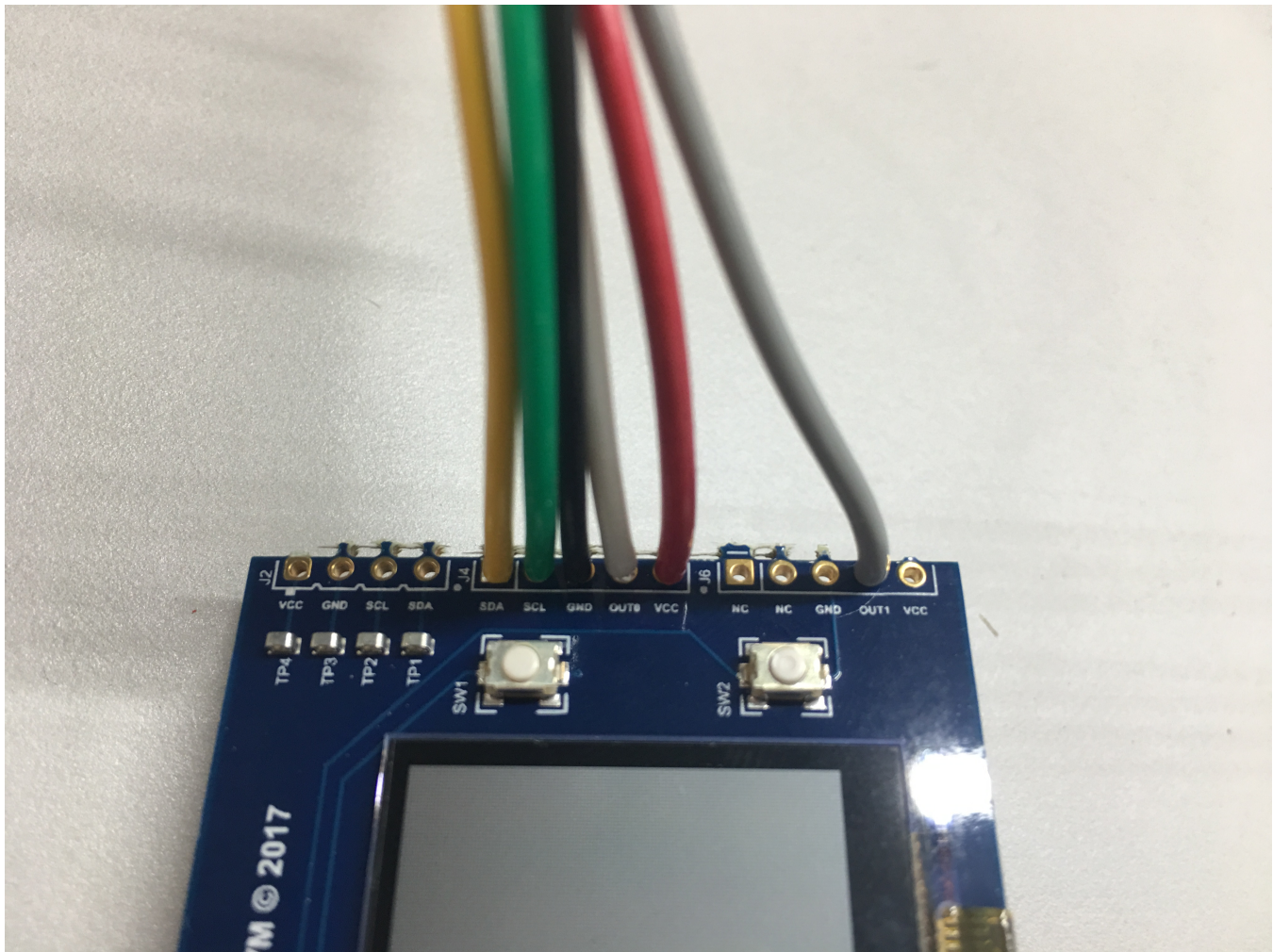

Figure 10. Motherboard Required Connections for Using All Three Channels

CAUTION

Many components on the EVM are susceptible to damage by electrostatic discharge (ESD). Customers are advised to observe proper ESD handling precautions when unpacking and handling the EVM, including the use of a grounded wrist strap at an approved ESD workstation.

2.4 EVM Features

This section describes some of the hardware features present on the EVM. Refer to [Figure 11](#) and [Figure 12](#) for the various designators described in this section.

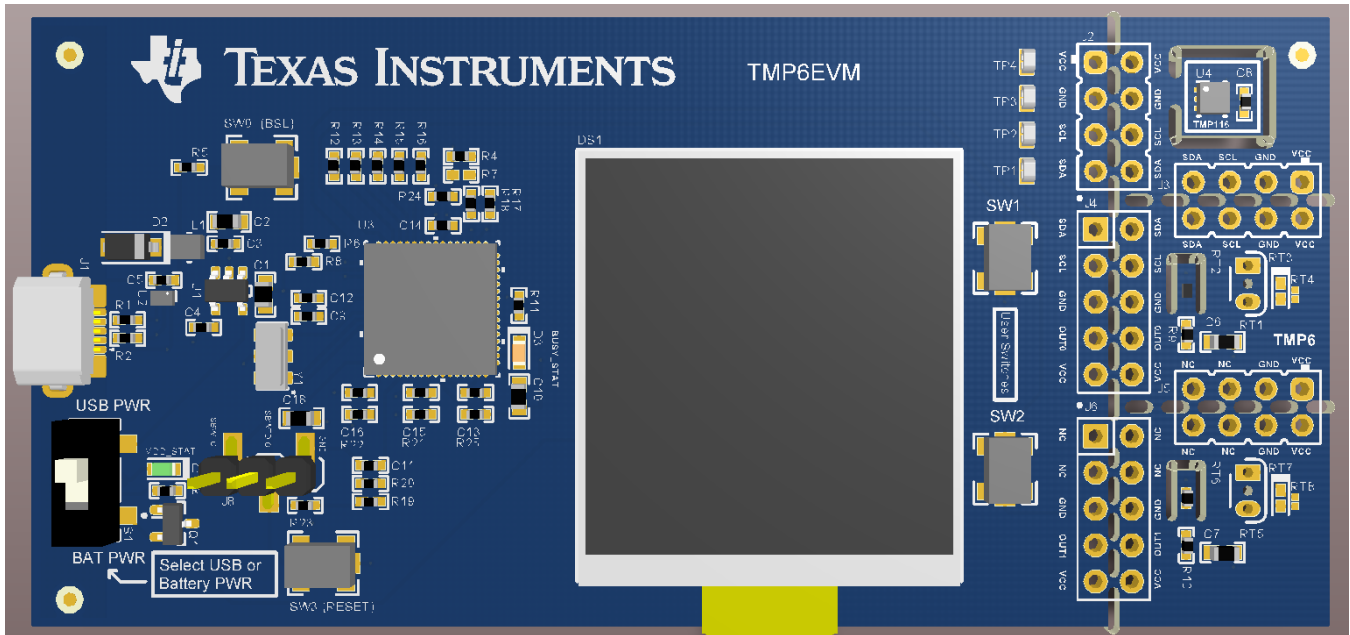

Figure 11. EVM 3D Top View

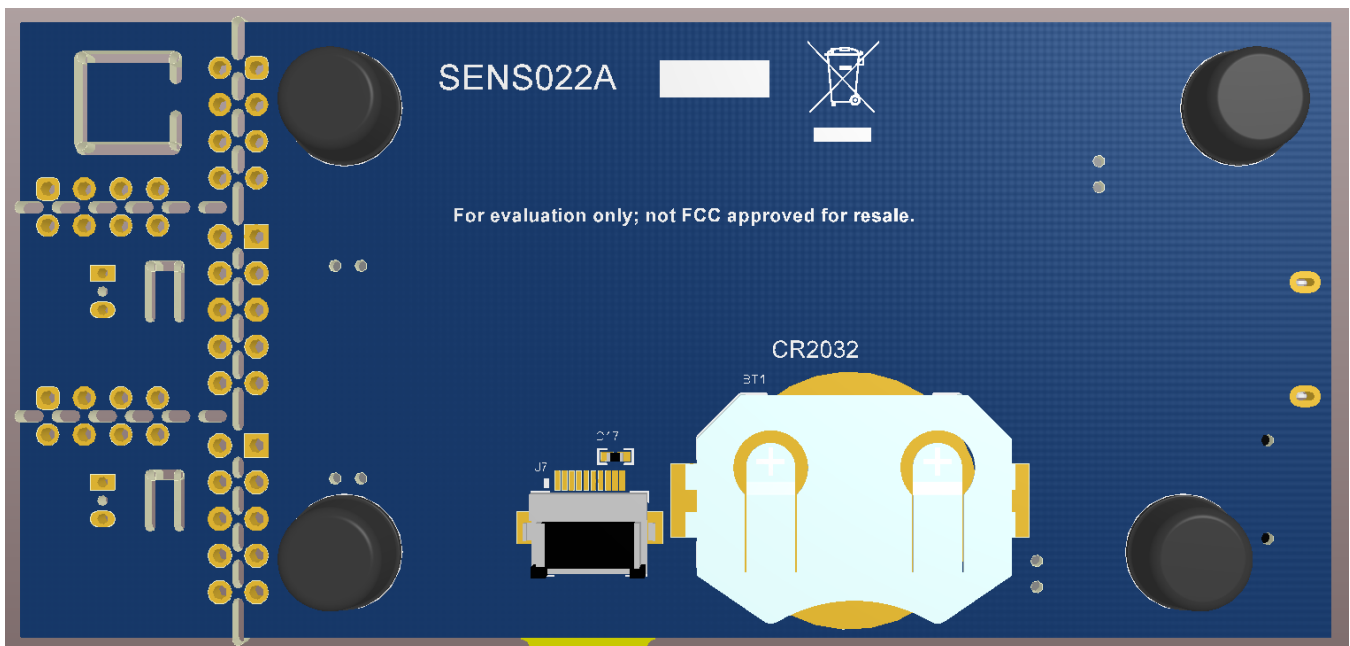

Figure 12. EVM 3D Bottom View

2.4.1 One Digital Channel

The EVM features one digital temperature sensor channel. The TMP116 digital local temperature sensor (U4) has an accuracy of $\pm 0.3^\circ\text{C}$ (maximum) from -40°C to 125°C . This high accuracy sensor is used as a local temperature reference.

2.4.2 Two Analog Channels

The EVM can support up to two analog channels. The first analog channel is dedicated for the TMP6 device (RT2), and the second channel is an optional channel (RT6). For this EVM, a NTC device is populated for the second analog channel.

2.4.3 Programming

Push button SW0 and J8 are available for Bootloader (BSL) and Spy-Bi-Wire (SBW) programming, respectively. To enter to BSL mode, hold down the BSL button while powering up the EVM. To flash the EVM in BSL mode, the user can use a program like *Python Firmware Upgrader GUI*.

2.4.4 ESD Protection

The EVM features an ESD protection circuit based on the [TPD4E004](#) device.

2.4.5 LDO

The EVM is powered from the USB rail. The USB 5-V rail is regulated to 3.0 V with the [LP2985AIM5X-3.0](#) device. The 3.0 V powers both the MSP430 microcontroller and the sensors. The sensor supply current can be monitored by replacing R4 with a current meter.

2.4.6 LED Indicators

There are two LED indicators on the EVM. The green LED (D1) indicates when the EVM is powered (USB or battery). The orange LED (D3) indicates when the microcontroller is active. The microcontroller only wakes up twice every second to update the LCD.

2.4.7 RC Filter

The TMP6EVM is designed to support a simple RC low-pass filter (R21 and C15 for Ch1; R22 and C16 for Ch2). The RC filter can be used to suppress electrical interference and to optimize ADC performance. In most analog designs, a filter capacitor is recommended. For a typical design, TI recommends a 0.1- μ F external capacitor (TMP6EVM default filter configuration).

2.4.8 VCC/Battery Monitor

The VCC/Battery rail voltage is monitored in this design through a voltage divider network (R19 and R20). The C11 capacitor is required due to the high source impedance of the divider network.

2.4.9 Reverse-Polarity Protection

The P-channel FET (Q1) is used to prevent accidental reverse-polarity when inserting a coin cell battery.

2.4.10 ADC Ratiometric Measurement

A basic ADC ratiometric measurement technique was employed for the analog channels to suppress the power supply and ADC reference voltage (V_{ref}) error contributions. This is accomplished by using the voltage divider bias voltage as the ADC V_{ref} also. The ADC code, which represents the ratio of input voltage to the V_{ref} , changes with the thermistor resistance as a function of temperature (ideally independent of the bias voltage). This approach provides great power supply rejection and tolerates V_{ref} error across different EVMs.

2.4.11 Primary EVM Display Mode

This is the default display mode following the quick user's guide page described earlier. Only the TMP116 (Ch0) and TMP6 (Ch1) temperature readings are displayed, as shown in [Figure 13](#). Briefly (for approximately half a second) hold down the user switch SW1 to toggle to the next display mode. To go back to the primary display, just hold down the SW1 again.

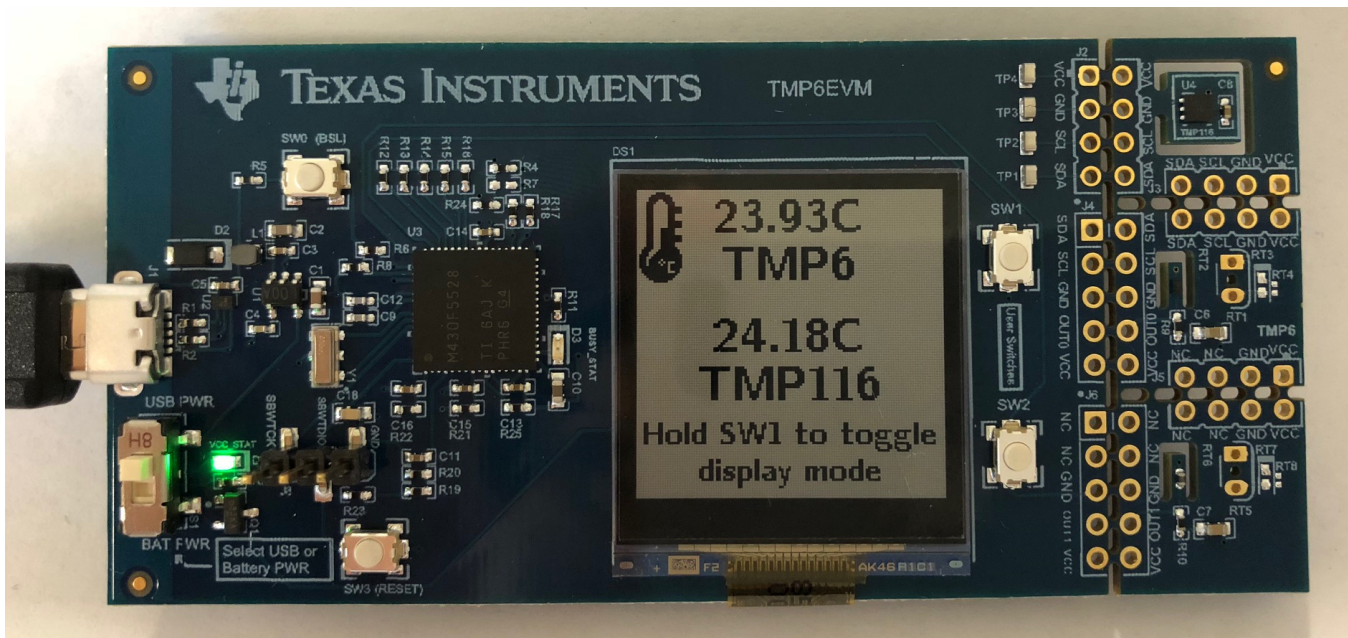

Figure 13. Primary EVM Display Mode

2.4.12 Secondary EVM Display Mode

The secondary display contains more detailed information, including channel 1 and channel 2 ADC code readouts, ADC voltage equivalent (assuming $V_{ref} = 3.0\text{ V}$), VCC/Battery voltage, and offset value relative to TMP116 used on power reset. In Figure 14, the TMP6 readout corresponds to Ch1 and the NTC readout corresponds to Ch2.

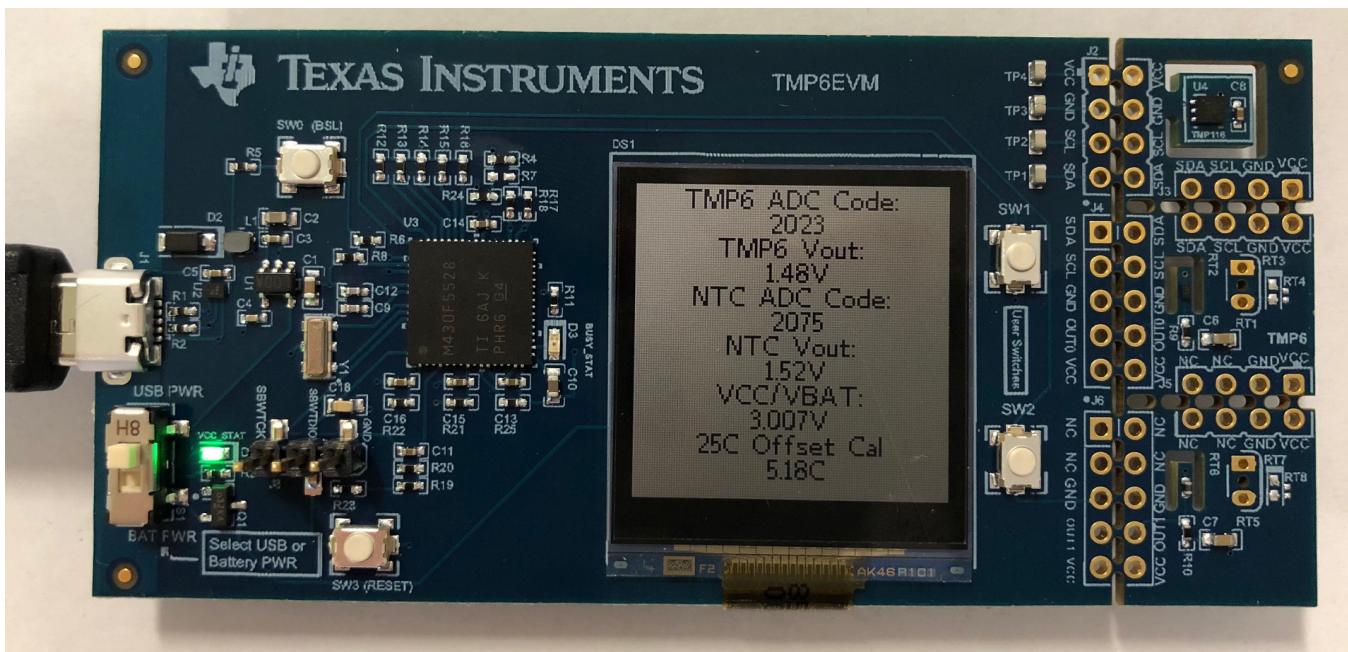

Figure 14. Secondary EVM Display Mode

3 EVM Software Setup

This section discusses how to install the EVM software.

3.1 Operating Systems for the EVM Software

The EVM software is tested on the Microsoft Windows 7 and 10 operating systems (OS) with United States and European regional settings. The software also functions on other Windows operating systems.

3.2 EVM Software Installation

The EVM software is available through the [TMP6EVM](#) product folder on the TI website.

1. Go to the [TMP6EVM](#) web page on the TI website and scroll down to the *Software* section to download the latest evaluation software.
2. Unzip the downloaded file into a known directory and run the *TMP6_EVM_GUI-1.0.0.setup-win_6.1.1.exe* file. The EVM software installer then begins the installation process, as shown in [Figure 15](#).

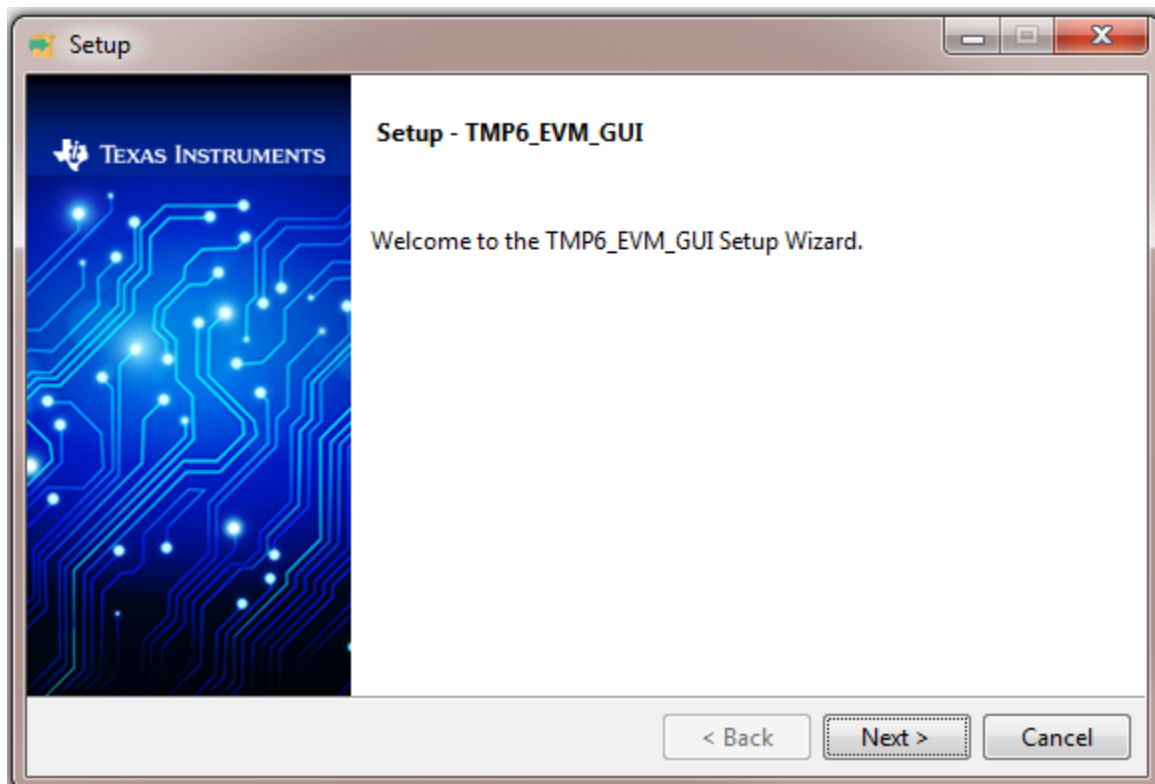

Figure 15. TMP6 EVM GUI Installation Wizard

3. Accept the license agreement and follow the on-screen instructions by clicking the *Next* button to install the software.

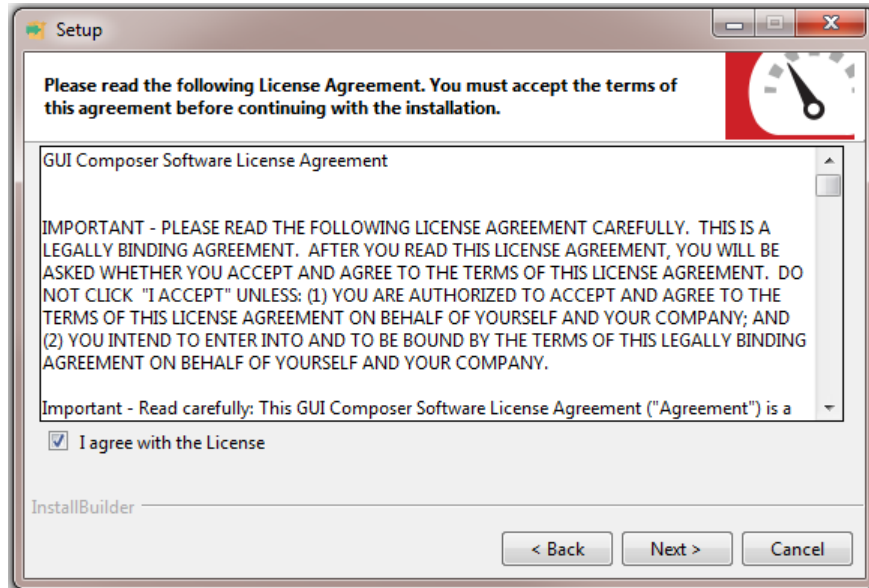

Figure 16. TMP6 EVM GUI License Agreement

4. Click on the *Next* button to accept the default installation directory.

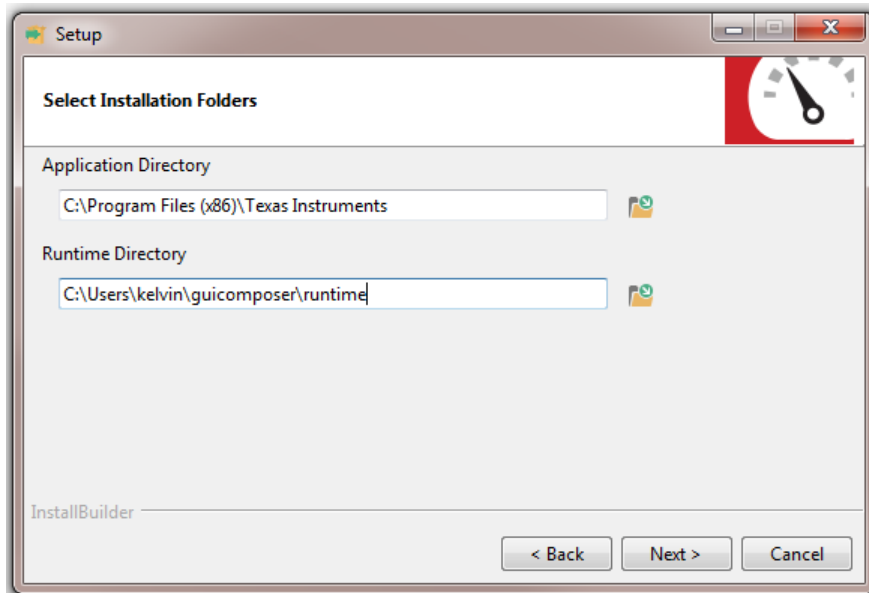

Figure 17. TMP6 EVM GUI Installation Folder Selection

5. The installer will begin as shown in [Figure 18](#).

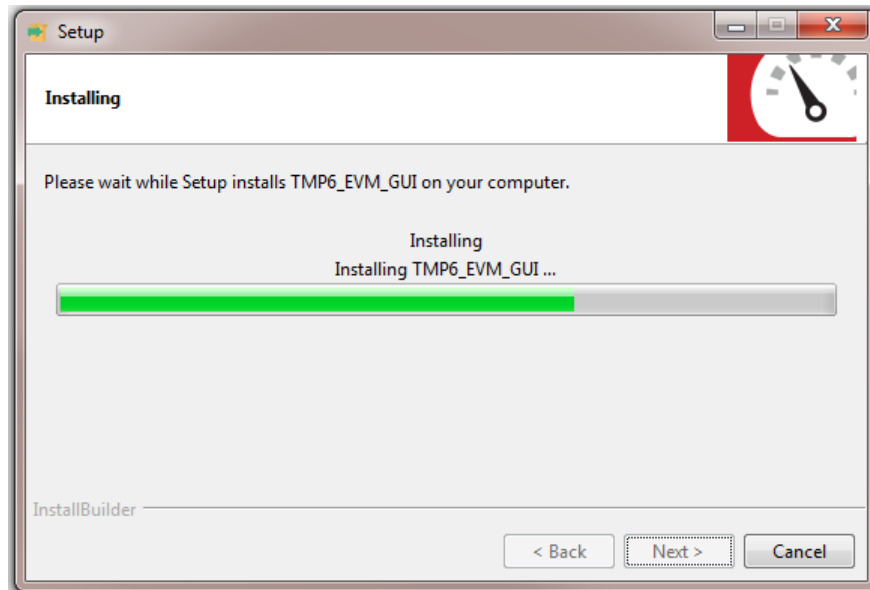

Figure 18. TMP6 EVM GUI Installation

6. When the installation is finished, click the *Finish* button. This will launch the GUI application.

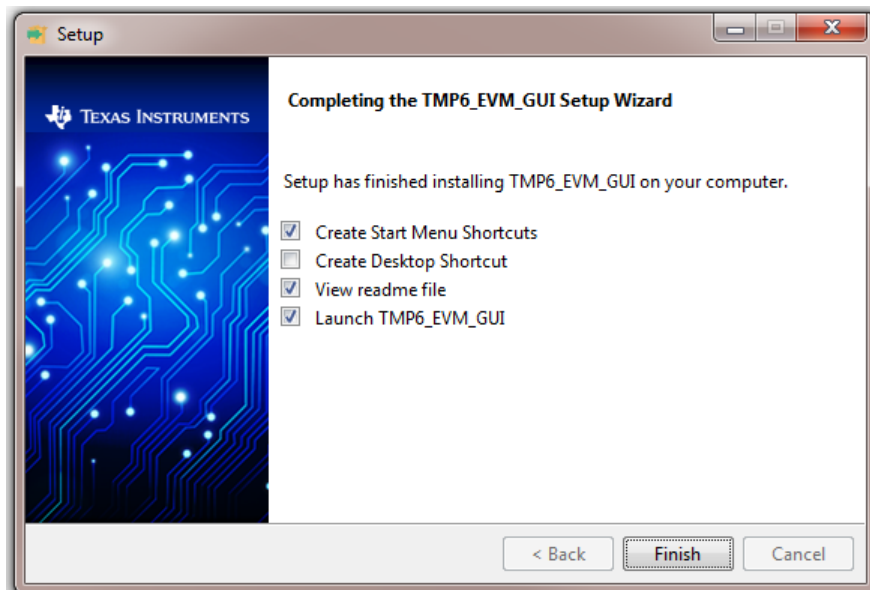

Figure 19. TMP6 EVM Installation Finish

- The first time the GUI launches, the README file will pop up. Make sure the EVM is now connected to the computer USB port. Closing the README pop-up will start the data logging chart.

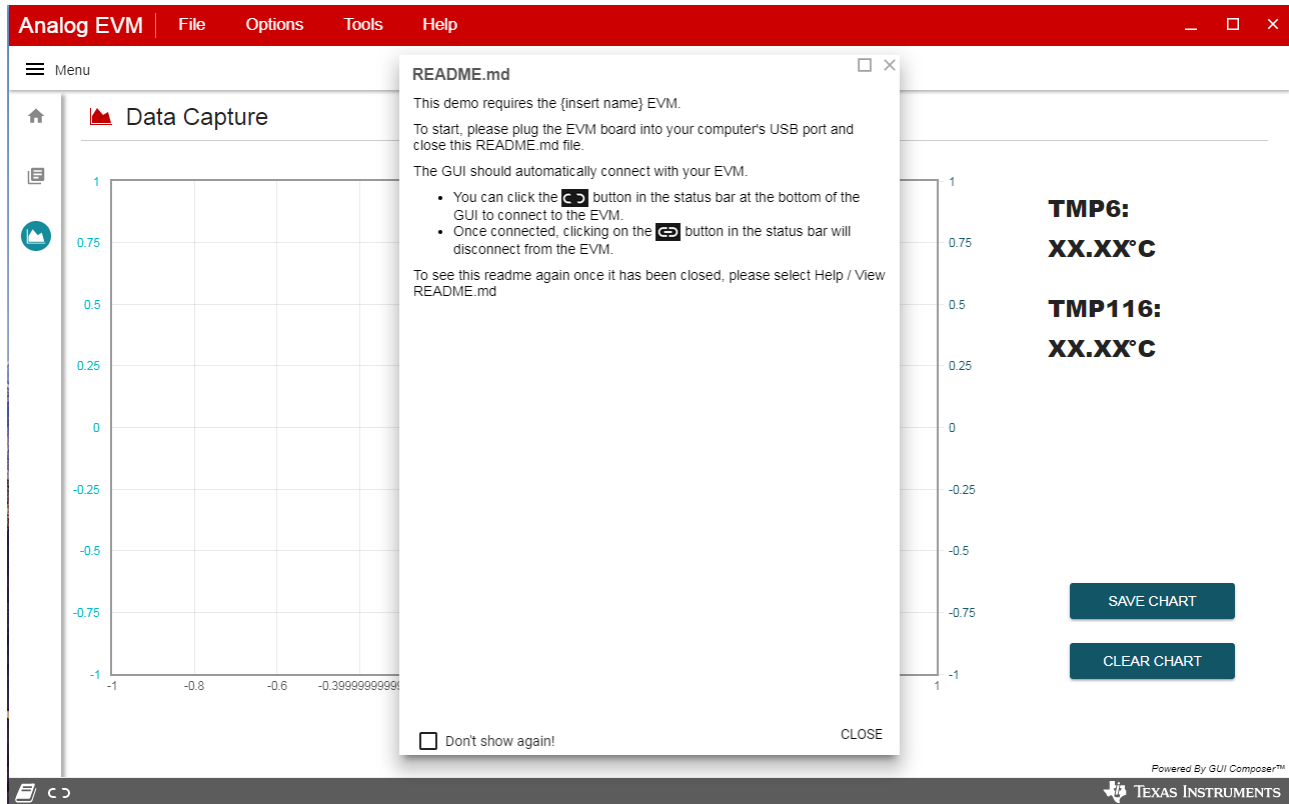

Figure 20. Launching the EVM GUI

- If the EVM hardware is not plugged in, the status bar will indicate the hardware not connected.

4 EVM Software Overview

This section discusses how to use the EVM software.

4.1 Home Page

The home page is shown in [Figure 21](#). The home page includes the EVM 3D model, features, and the EVM block diagram.

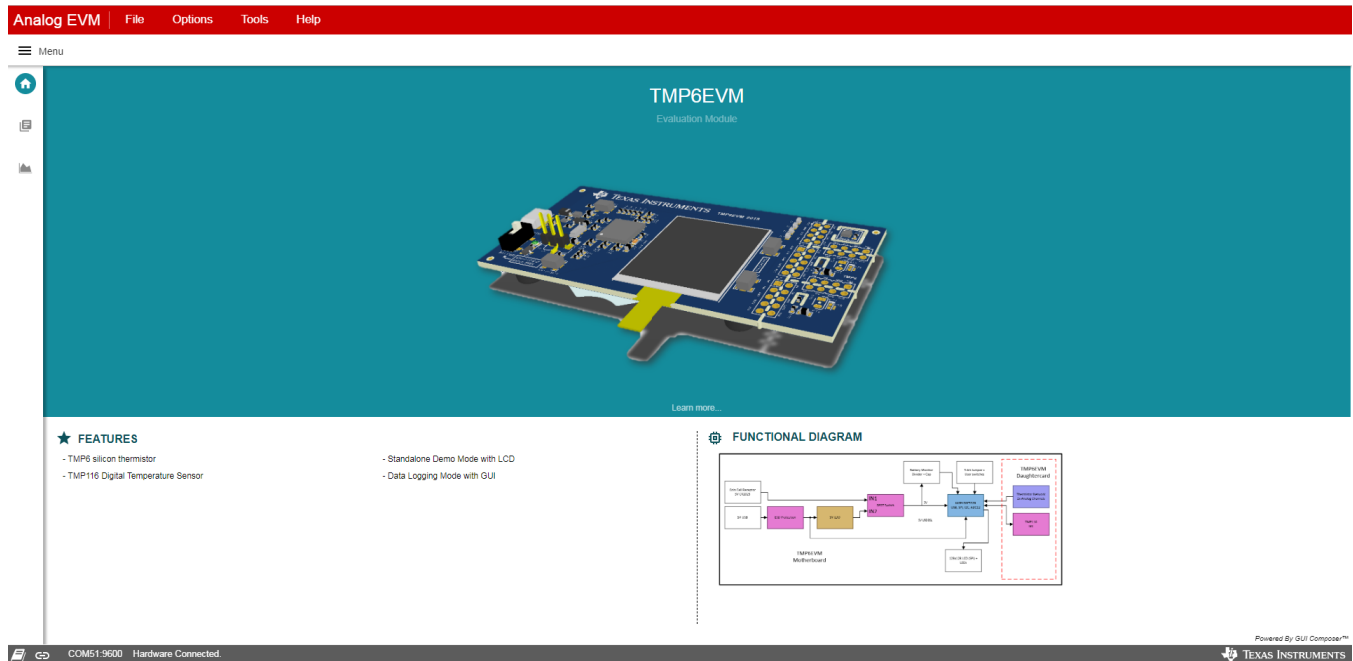

Figure 21. Home Page

4.2 Collateral Page

The collateral page is shown in [Figure 22](#). The page includes links to the device data sheet, EVM user's guide, and other relevant technical documents.

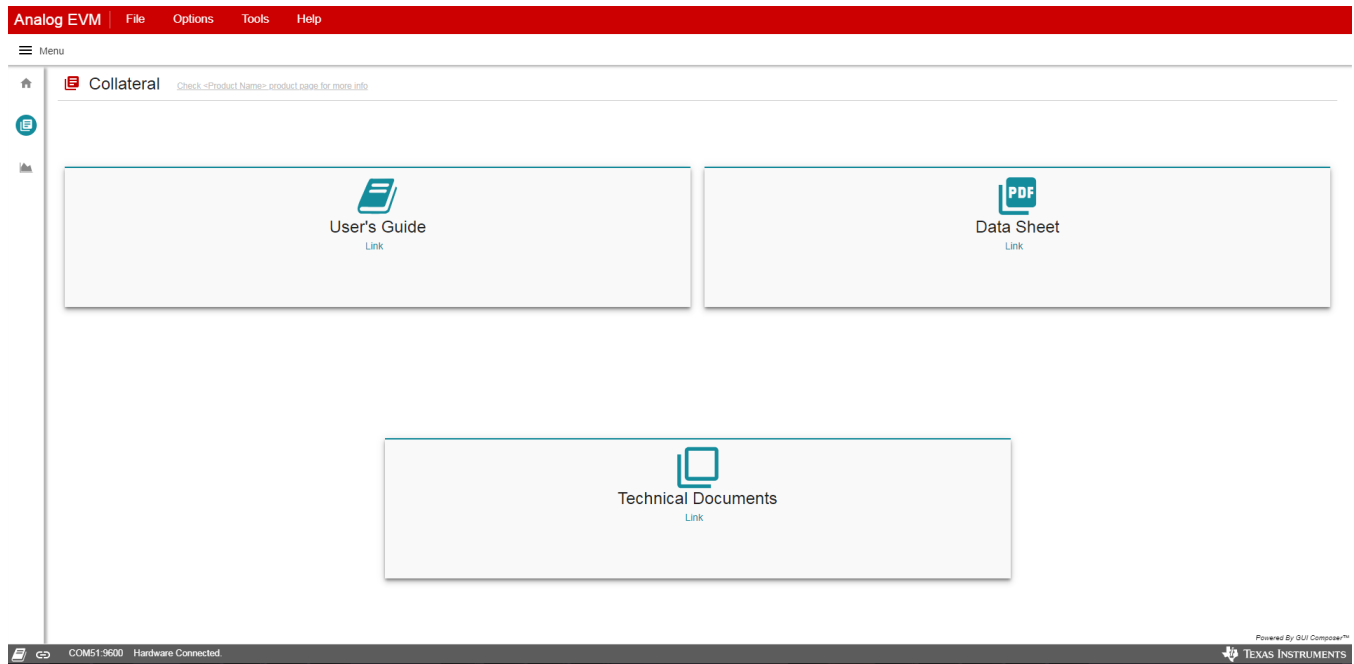

Figure 22. Collateral Page

4.3 Data Capture

The data capture page is shown in Figure 23. The dual y-axis has units in degree Celsius. The left y-axis is for the TMP6 and the right y-axis is for the TMP116. The x-axis is the sample number. The cursor number is the current sample number the cursor is on.

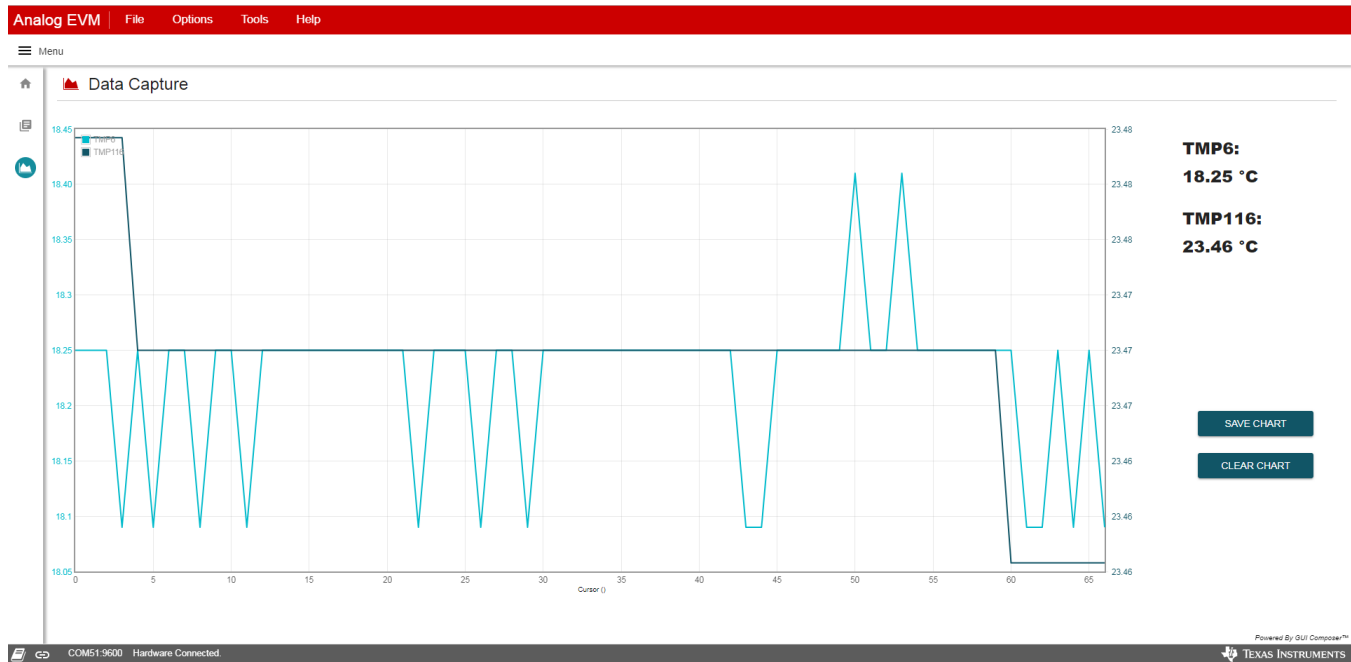

Figure 23. Data Capture

4.4 Chart Settings

4.4.1 Acquisition Rate

The chart data sampling rate is fixed to 1 Hz.

4.4.2 Chart Refresh

The chart can be cleared by clicking on the *Clear Chart* button.

4.4.3 Save Data

Data acquired can be exported to a CSV file.

5 EVM Documentation

This section contains the schematic diagram, layout, and complete bill of materials (BOM) for the EVM.

5.1 EVM Schematic

Figure 24 shows the schematic for the TMP6EVM board.

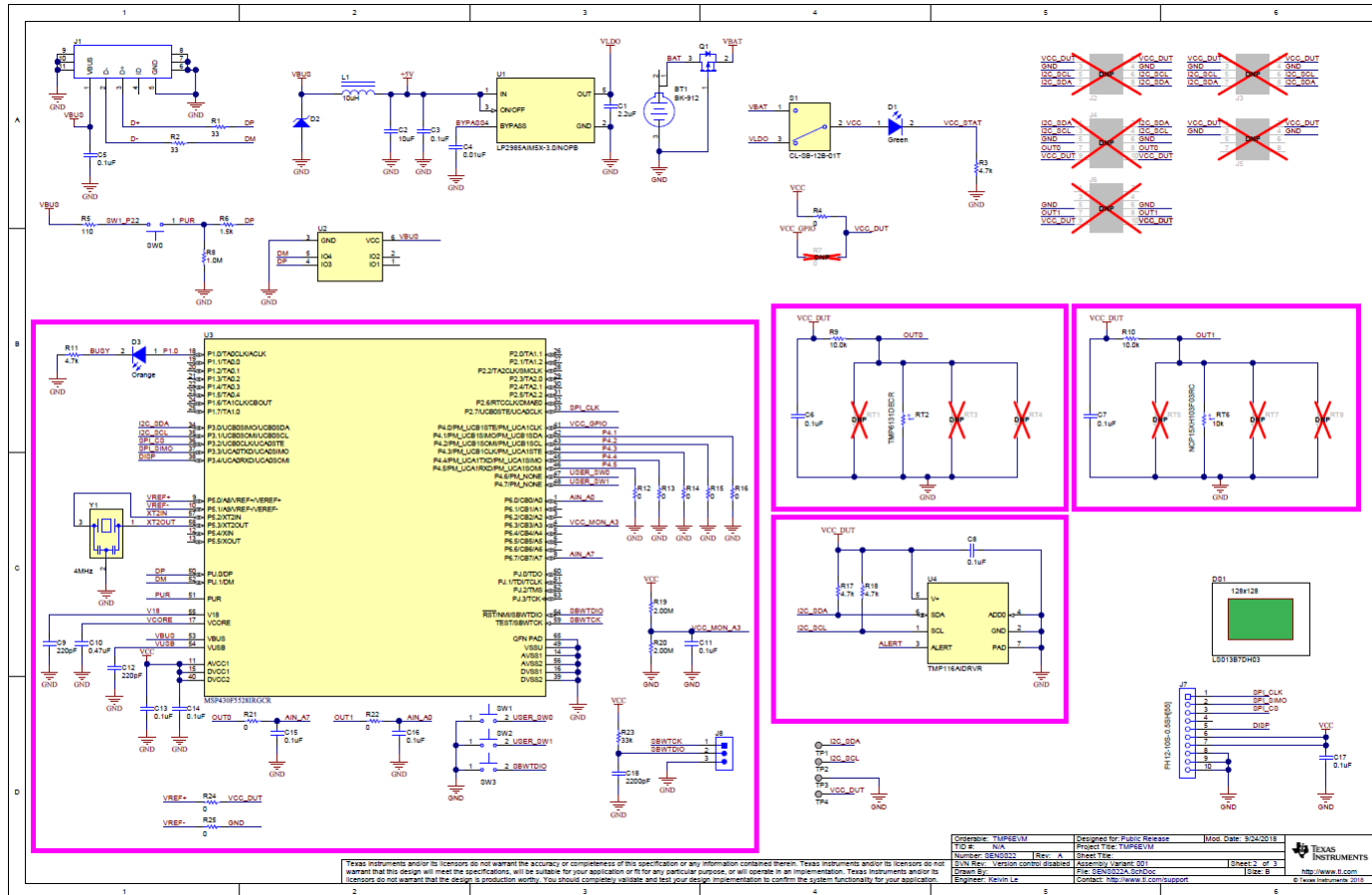

Figure 24. EVM Schematic

5.2 EVM PCB Layout

Figure 25 through Figure 30 show the layout for the TMP6EVM board.

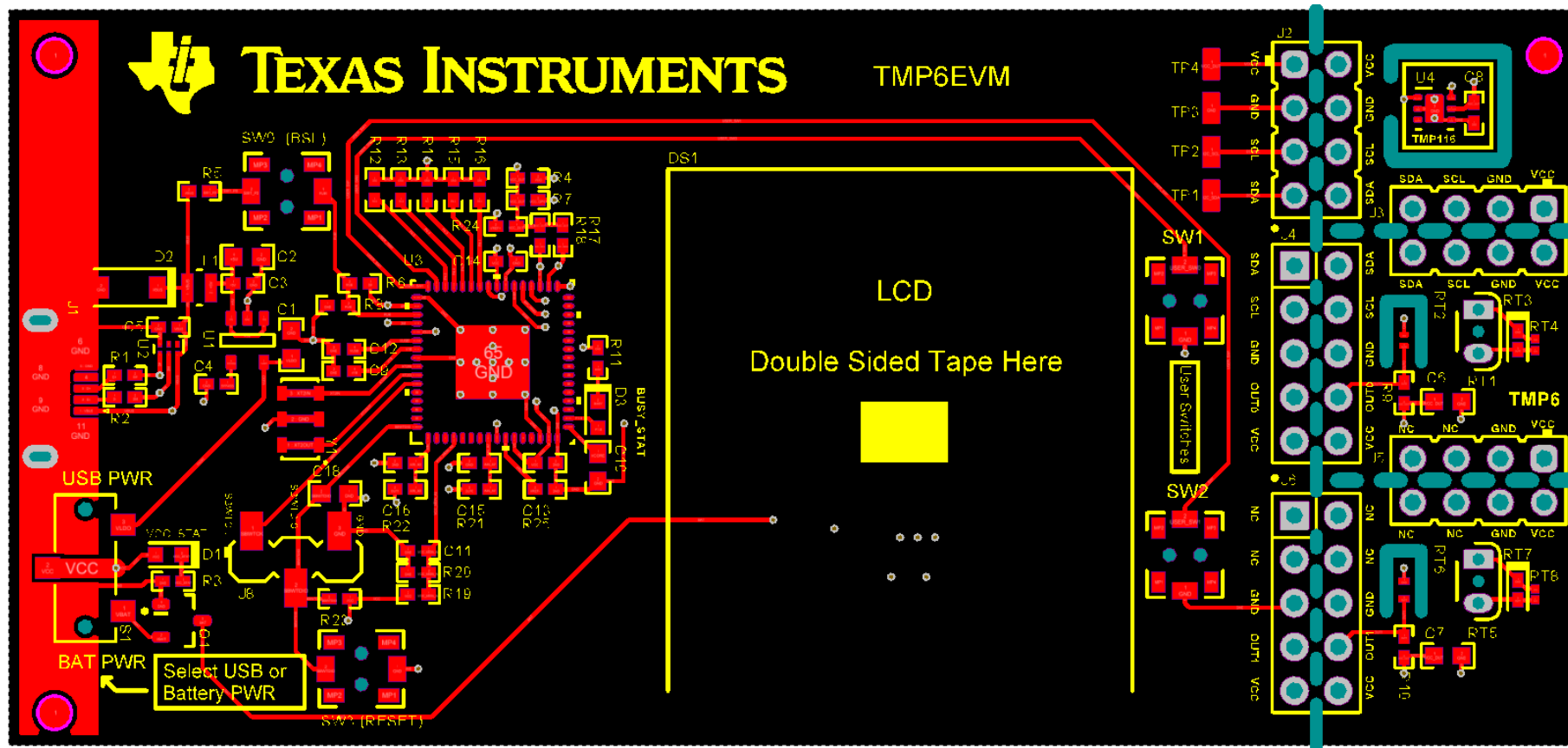

Figure 25. Top Layers

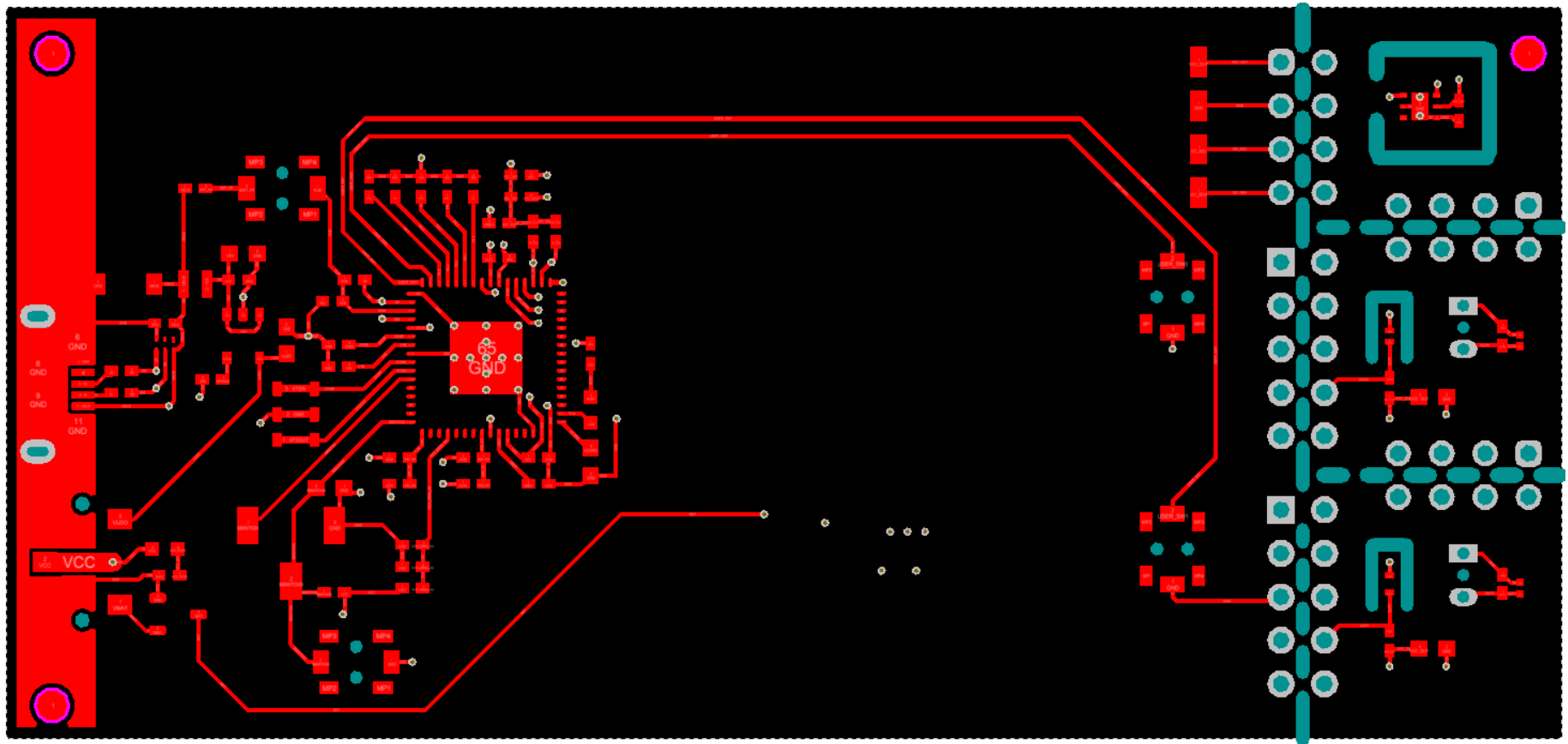

Figure 26. Top Signal Layer

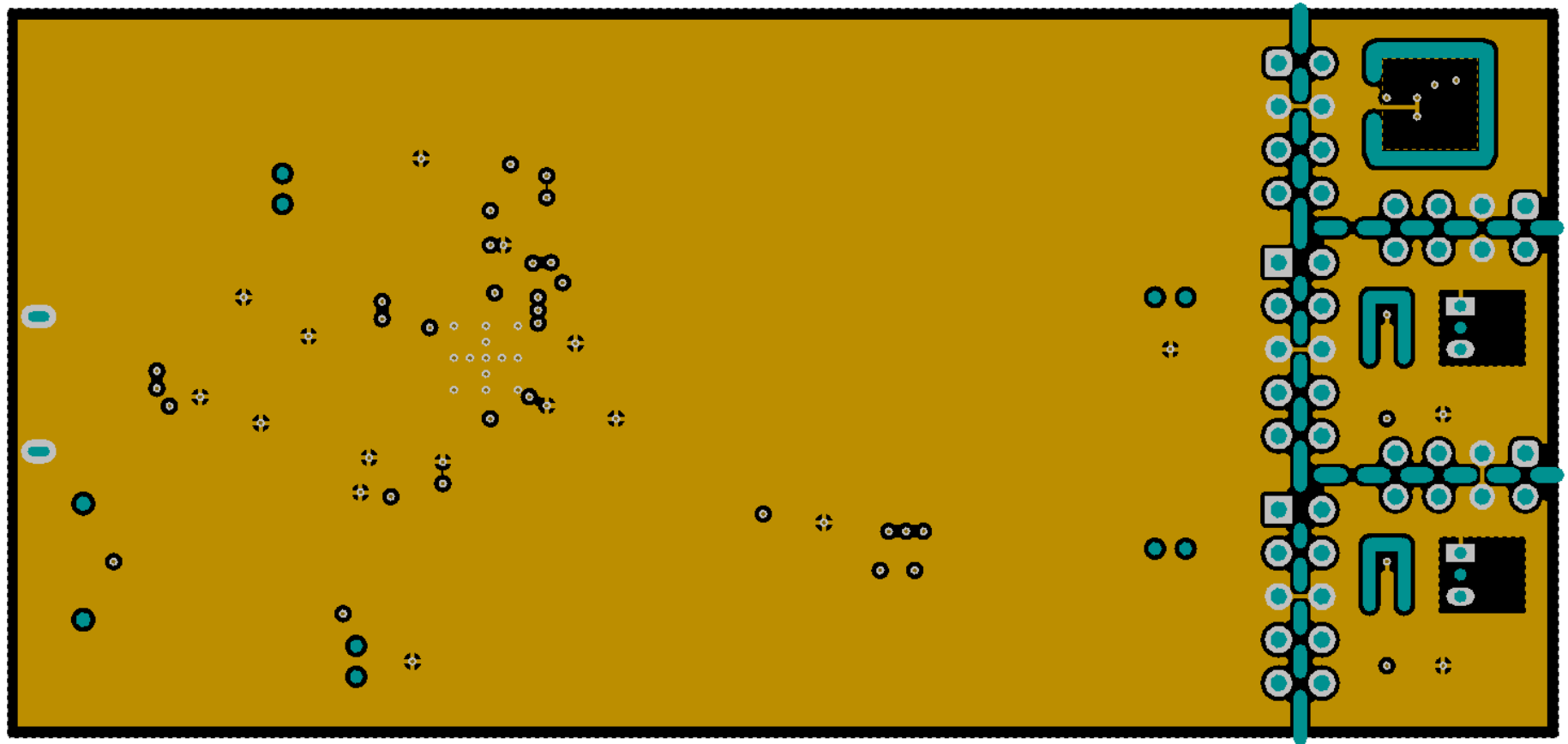

Figure 27. Ground Layer

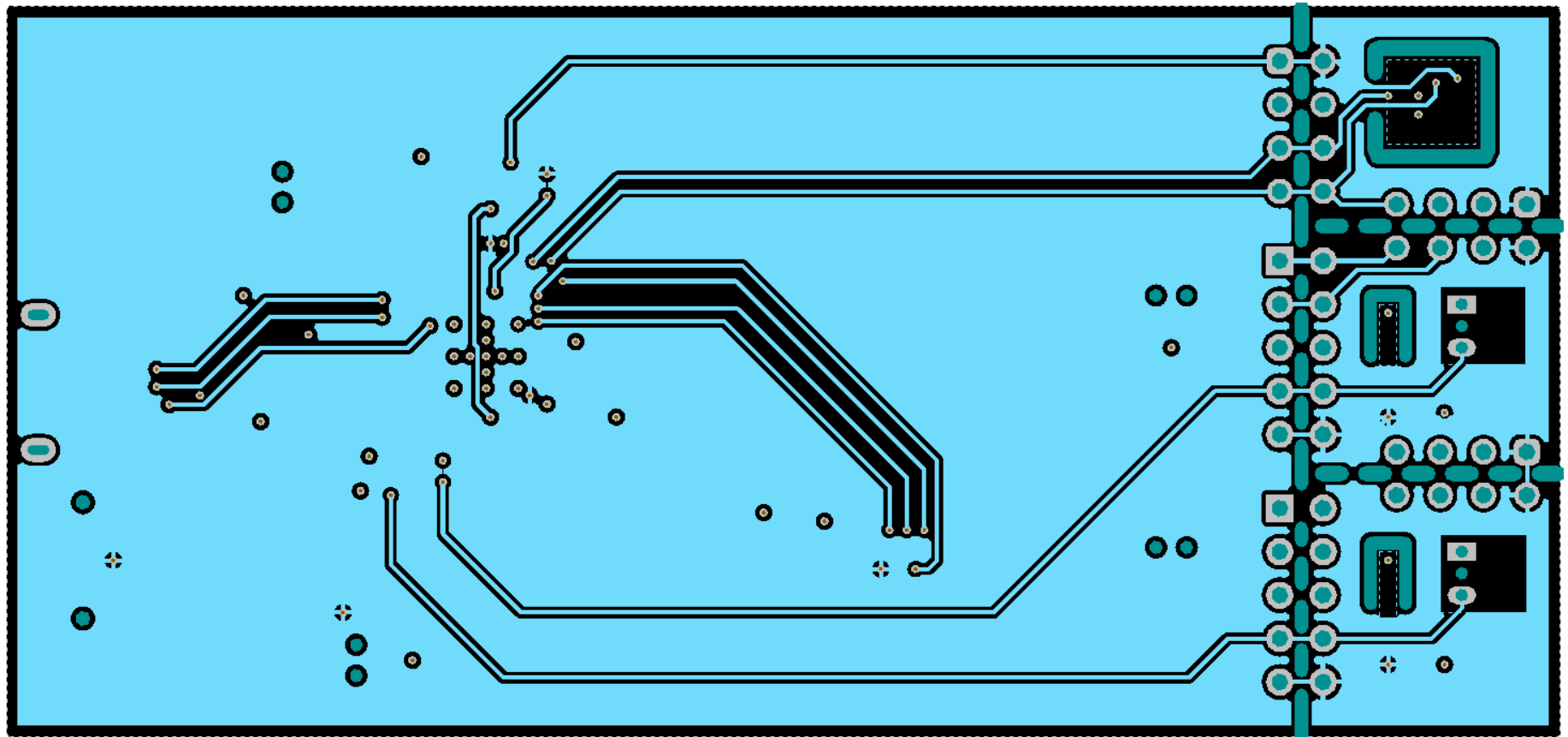

Figure 28. Power Layer

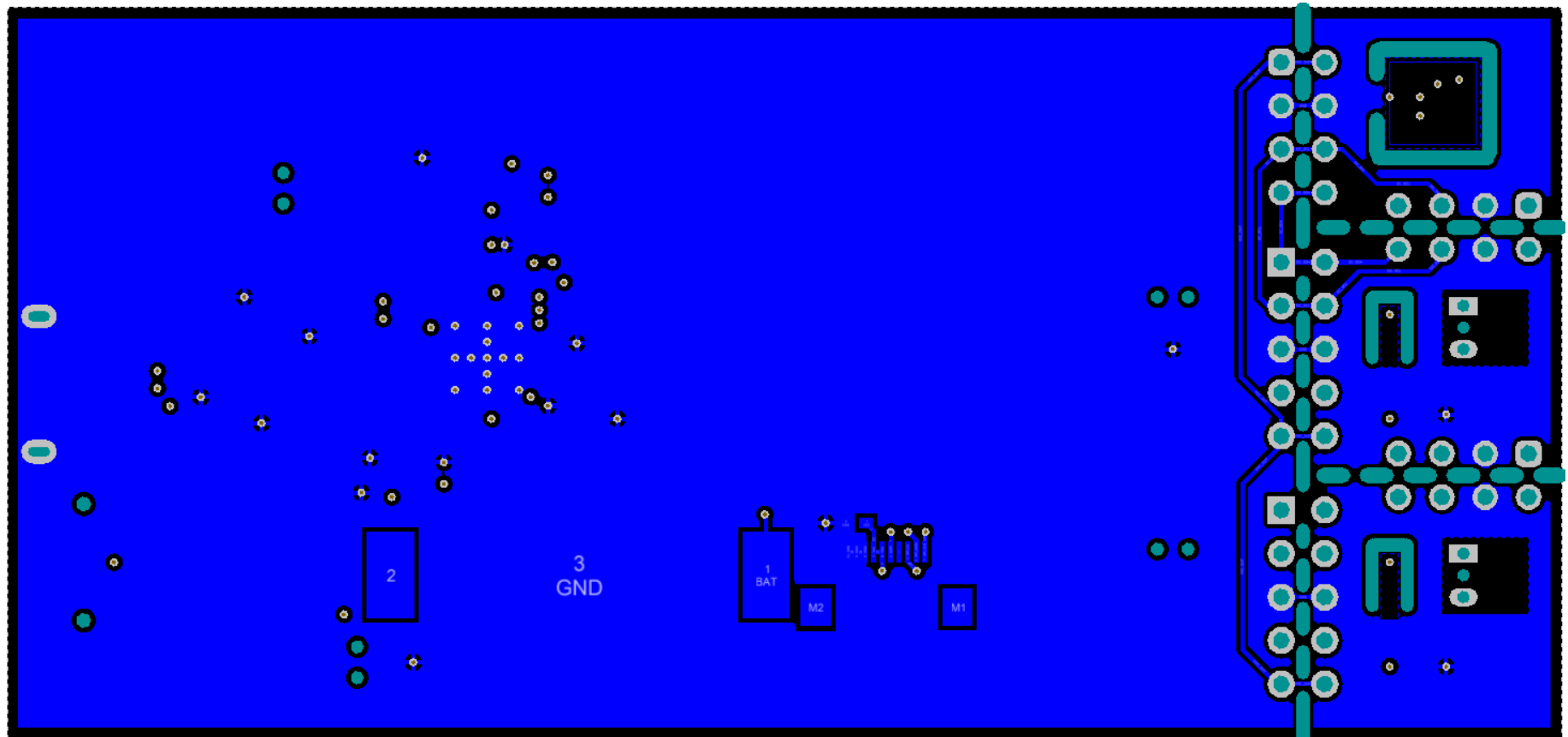

Figure 29. Bottom Signal Layer

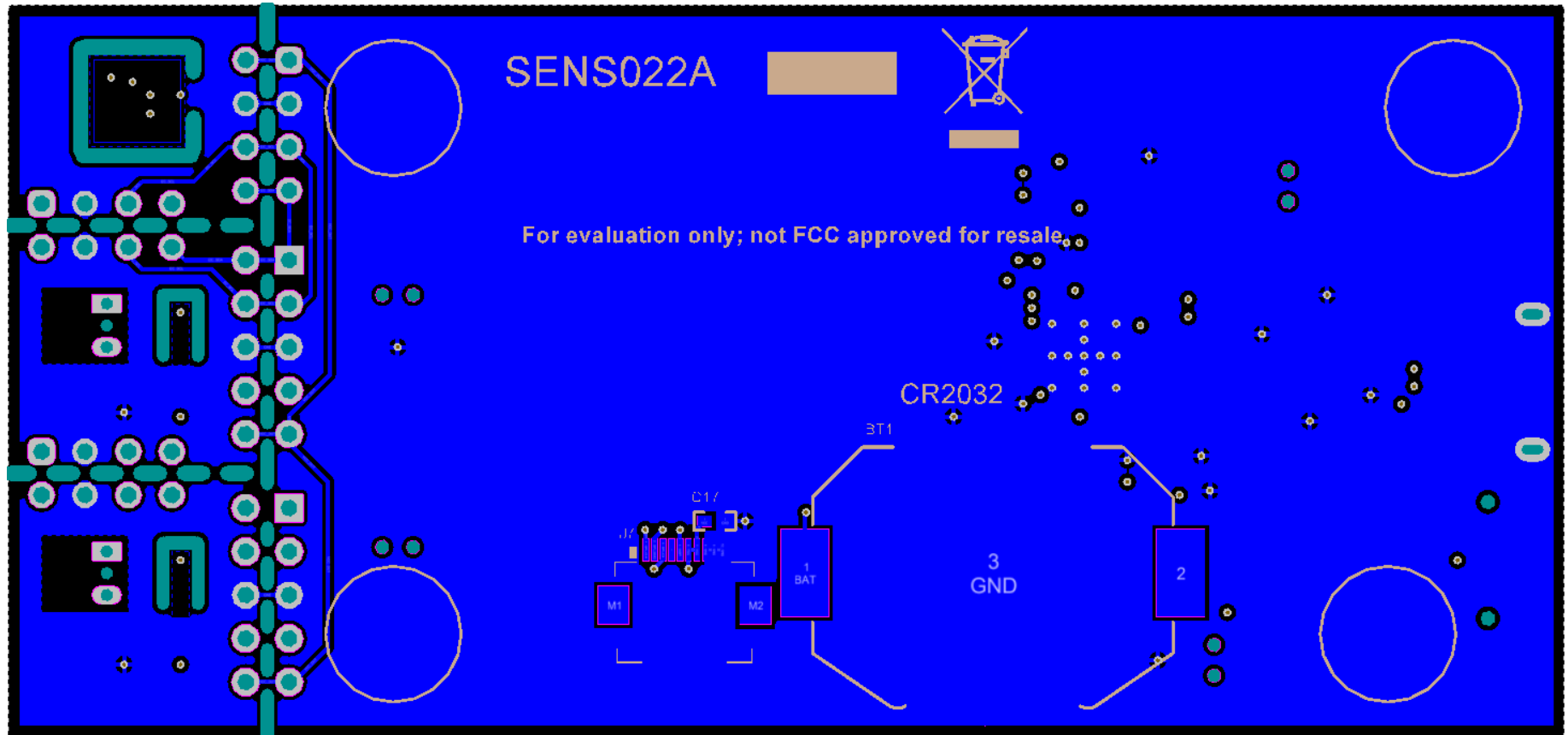

Figure 30. Bottom Layers

5.3 EVM Bill of Materials

Table 3 lists the bill of materials for the EVM.

Table 3. EVM Bill of Material

Designator	Quantity	Value	Description	PackageReference	PartNumber	Manufacturer
BT1	1		Battery Holder for CR2032, SMT	Battery Holder for CR2032, SMT	BK-912	Memory Protection Devices
C1	1	2.2uF	CAP, CERM, 2.2 uF, 10 V, +/- 10%, X5R, 0603	0603	C0603C225K8PACTU	Kemet
C2	1	10uF	CAP, CERM, 10 uF, 10 V, +/- 20%, X5R, 0603	0603	C1608X5R1A106M080A C	TDK
C3, C5, C8, C13, C14, C15, C16	7	0.1uF	CAP, CERM, 0.1 uF, 16 V, +/- 5%, X7R, 0402	0402	GRM155R71C104JA88D	MuRata
C4	1	0.01uF	CAP, CERM, 0.01 uF, 16 V, +/- 10%, X7R, 0402	0402	GRM155R71C103KA01D	MuRata
C6, C7	2	0.1uF	CAP, CERM, 0.1 uF, 16 V, +/- 5%, X7R, 0603	0603	0603YC104JAT2A	AVX
C9, C12	2	220pF	CAP, CERM, 220 pF, 50 V, +/- 5%, COG/NP0, 0402	0402	GRM1555C1H221JA01D	MuRata
C10	1	0.47uF	CAP, CERM, 0.47 uF, 10 V, +/- 10%, X7R, 0603	0603	C0603C474K8RACTU	Kemet
C11, C17	2	0.1uF	CAP, CERM, 0.1 uF, 10 V, +/- 10%, X5R, 0402	0402	GRM155R61A104KA01D	MuRata
C18	1	2200pF	CAP, CERM, 2200 pF, 50 V, +/- 10%, X7R, 0603	0603	C0603X222K5RACTU	Kemet
D1	1	Green	LED, Green, SMD	LED_0603	LTST-C191TGKT	Lite-On
D2	1	5.6V	Diode, Zener, 5.6 V, 500 mW, SOD-123	SOD-123	MMSZ5232B-7-F	Diodes Inc.
D3	1	Orange	LED, Orange, SMD	LED_0603	LTST-C191KFKT	Lite-On
DS1	1		LCD Display Dot Pixels 128x128	LCD Display Dot Pixels 128x128	LS013B7DH03	Sharp Microelectronics
H1, H2, H3, H4	4		Bumpon, Cylindrical, 0.312 X 0.200, Black	Black Bumpon	SJ61A1	3M
J1	1		Receptacle, USB 2.0, Micro B, 5 Position, R/A, SMT	Receptacle, USB 2.0, Micro B, 5 Pos, 0.65mm Pitch, R/A, SMT	1051640001	Molex
J7	1		Connector, FPC 10 Pos. 9.1x2.0x5.6 mm	Connector PFC, 9.1x2.0x5.6mm	FH12-10S-0.5SH(55)	Hirose Electric Co. Ltd.
J8	1		Header, 2.54mm, 3x1, Gold, SMT	Header, 2.54mm, 3x1, SMT	M20-8770342	Harwin

Table 3. EVM Bill of Material (continued)

Designator	Quantity	Value	Description	PackageReference	PartNumber	Manufacturer
L1	1	10uH	Inductor, Shielded, Ferrite, 10 uH, 0.4 A, 1.38 ohm, SMD	2.0x0.95x1.6mm	VLS201610ET-100M	TDK
Q1	1	-20V	MOSFET, P-CH, -20 V, -3.7 A, SOT-23	SOT-23	SI2323DS	Vishay-Siliconix
R1, R2	2	33	RES, 33, 5%, 0.063 W, 0402	0402	CRCW040233R0JNED	Vishay-Dale
R3, R11, R17, R18	4	4.7k	RES, 4.7 k, 5%, 0.063 W, 0402	0402	CRCW04024K70JNED	Vishay-Dale
R4, R12, R13, R14, R15, R16, R21, R22, R24, R25	10	0	RES, 0, 5%, 0.063 W, 0402	0402	CRCW04020000Z0ED	Vishay-Dale
R5	1	110	RES, 110, 5%, 0.063 W, 0402	0402	CRCW0402110RJNED	Vishay-Dale
R6	1	1.5k	RES, 1.5 k, 5%, 0.063 W, 0402	0402	CRCW04021K50JNED	Vishay-Dale
R8	1	1.0Meg	RES, 1.0 M, 5%, 0.063 W, 0402	0402	CRCW04021M00JNED	Vishay-Dale
R9, R10	2	10.0k	RES, 10.0 k, 1%, 0.063 W, 0402	0402	CRCW040210K0FKED	Vishay-Dale
R19, R20	2	2.00Meg	RES, 2.00 M, 1%, 0.063 W, 0402	0402	CRCW04022M00FKED	Vishay-Dale
R23	1	33k	RES, 33 k, 5%, 0.063 W, 0402	0402	CRCW040233K0JNED	Vishay-Dale
RT2	1		Thermistor, DEC0002A (X1SON-2)	DEC0002A	TMP6131DECR	Texas Instruments
RT6	1	10k	Thermistor NTC, 10.0k ohm, 1%, 0402	0402	NCP15XH103F03RC	MuRata
S1	1		Switch, Slide, SPDT, 0.2A, GULL, 12V, SMD	SMD, 3-Leads, Body 8.5x3.5mm, Pitch 2.5mm	CL-SB-12B-01T	Copal Electronics
SW0, SW1, SW2, SW3	4		Switch, SPST-NO, Off-Mom, 0.05A, 12VDC, SMD	3.9x2.9mm	PTS820 J20M SMTR LFS	C&K Components
TP1, TP2, TP3, TP4	4		Natural PC Test Point Brass, SMT	Natural PC Test Point Brass, SMT	S2761-46R	Harwin
U1	1		Micropower 150-mA Low-Noise Ultra-Low-Dropout Regulator in SOT-23 and DSBGA Packages, DBV0005A (SOT-23-5)	DBV0005A	LP2985AIM5X-3.0/NOPB	Texas Instruments

Table 3. EVM Bill of Material (continued)

Designator	Quantity	Value	Description	PackageReference	PartNumber	Manufacturer
U2	1		ESD-Protection Array for High-Speed Data Interfaces, 4 Channels, -40 to +85 degC, 6-pin SON (DRY), Green (RoHS & no Sb/Br)	DRY0006A	TPD4E004DRYR	Texas Instruments
U3	1		25 MHz Mixed Signal Microcontroller with 128 KB Flash, 8192 B SRAM and 47 GPIOs, -40 to 85 degC, 64-pin QFN (RGC), Green (RoHS & no Sb/Br)	RGC0064B	MSP430F5528IRGCR	Texas Instruments
U4	1		High-Accuracy, Low-Power, Digital Temperature Sensor with SMBus and Two-Wire Serial Interface, DRV0006A (WSON-6)	DRV0006A	TMP116AIDRVR	Texas Instruments
Y1	1		Resonator, 4 MHz, 39pF SMD	4.5x1.2x2 mm	CSTCR4M00G15L99-R0	MuRata
FID1, FID2, FID3	0		Fiducial mark. There is nothing to buy or mount.	N/A	N/A	N/A
J2, J3, J5	0		Header, 2.54mm, 4x2, Gold, TH	Header, 2.54mm, 4x2, TH	TSW-104-08-L-D	Samtec
J4, J6	0		Header, 100mil, 5x2, Gold, TH	5x2 Header	TSW-105-07-G-D	Samtec
R7	0	0	RES, 0, 5%, 0.063 W, 0402	0402	CRCW04020000Z0ED	Vishay-Dale
RT1, RT5	0		Thermistor, LPG0002A (TO-92-2)	LPG0002A	PTC1131LPG	Texas Instruments
RT3, RT7	0		Thermistor, SOD-523	SOD-523	PTC1131SOD523	Texas Instruments
RT4, RT8	0		Thermistor, 0201	0201	PTC11310201	Texas Instruments
C1	1	2.2uF	CAP, CERM, 2.2 uF, 10 V, +/- 10%, X5R, 0603	0603	C0603C225K8PACTU	Kemet
C2	1	10uF	CAP, CERM, 10 uF, 10 V, +/- 20%, X5R, 0603	0603	C1608X5R1A106M080A C	TDK
C3, C5, C8, C13, C14, C15, C16	7	0.1uF	CAP, CERM, 0.1 uF, 16 V, +/- 5%, X7R, 0402	0402	GRM155R71C104JA88D	MuRata
C4	1	0.01uF	CAP, CERM, 0.01 uF, 16 V, +/- 10%, X7R, 0402	0402	GRM155R71C103KA01D	MuRata

Table 3. EVM Bill of Material (continued)

Designator	Quantity	Value	Description	PackageReference	PartNumber	Manufacturer
C6, C7	2	0.1uF	CAP, CERM, 0.1 uF, 16 V, +/- 5%, X7R, 0603	0603	0603YC104JAT2A	AVX
C9, C12	2	220pF	CAP, CERM, 220 pF, 50 V, +/- 5%, COG/NP0, 0402	0402	GRM1555C1H221JA01D	MuRata
C10	1	0.47uF	CAP, CERM, 0.47 uF, 10 V, +/- 10%, X7R, 0603	0603	C0603C474K8RACTU	Kemet
C11, C17	2	0.1uF	CAP, CERM, 0.1 uF, 10 V, +/- 10%, X5R, 0402	0402	GRM155R61A104KA01D	MuRata
C18	1	2200pF	CAP, CERM, 2200 pF, 50 V, +/- 10%, X7R, 0603	0603	C0603X222K5RACTU	Kemet
D1	1	Green	LED, Green, SMD	LED_0603	LTST-C191TGKT	Lite-On
D2	1	5.6V	Diode, Zener, 5.6 V, 500 mW, SOD-123	SOD-123	MMSZ5232B-7-F	Diodes Inc.
D3	1	Orange	LED, Orange, SMD	LED_0603	LTST-C191KFKT	Lite-On
DS1	1		LCD Display Dot Pixels 128x128	LCD Display Dot Pixels 128x128	LS013B7DH03	Sharp Microelectronics
H1, H2, H3, H4	4		Bumpon, Cylindrical, 0.312 X 0.200, Black	Black Bumpon	SJ61A1	3M
J1	1		Receptacle, USB 2.0, Micro B, 5 Position, R/A, SMT	Receptacle, USB 2.0, Micro B, 5 Pos, 0.65mm Pitch, R/A, SMT	1051640001	Molex
J7	1		Connector, FPC 10 Pos. 9.1x2.0x5.6 mm	Connector PFC, 9.1x2.0x5.6mm	FH12-10S-0.5SH(55)	Hirose Electric Co. Ltd.
J8	1		Header, 2.54mm, 3x1, Gold, SMT	Header, 2.54mm, 3x1, SMT	M20-8770342	Harwin
L1	1	10uH	Inductor, Shielded, Ferrite, 10 uH, 0.4 A, 1.38 ohm, SMD	2.0x0.95x1.6mm	VLS201610ET-100M	TDK
Q1	1	-20V	MOSFET, P-CH, -20 V, -3.7 A, SOT-23	SOT-23	SI2323DS	Vishay-Siliconix
R1, R2	2	33	RES, 33, 5%, 0.063 W, 0402	0402	CRCW040233R0JNED	Vishay-Dale
R3, R11, R17, R18	4	4.7k	RES, 4.7 k, 5%, 0.063 W, 0402	0402	CRCW04024K70JNED	Vishay-Dale
R4, R12, R13, R14, R15, R16, R21, R22, R24, R25	10	0	RES, 0, 5%, 0.063 W, 0402	0402	CRCW04020000Z0ED	Vishay-Dale
R5	1	110	RES, 110, 5%, 0.063 W, 0402	0402	CRCW0402110RJNED	Vishay-Dale

Table 3. EVM Bill of Material (continued)

Designator	Quantity	Value	Description	PackageReference	PartNumber	Manufacturer
R6	1	1.5k	RES, 1.5 k, 5%, 0.063 W, 0402	0402	CRCW04021K50JNED	Vishay-Dale
R8	1	1.0Meg	RES, 1.0 M, 5%, 0.063 W, 0402	0402	CRCW04021M00JNED	Vishay-Dale
R9, R10	2	10.0k	RES, 10.0 k, 1%, 0.063 W, 0402	0402	CRCW040210K0FKED	Vishay-Dale
R19, R20	2	2.00Meg	RES, 2.00 M, 1%, 0.063 W, 0402	0402	CRCW04022M00FKED	Vishay-Dale
R23	1	33k	RES, 33 k, 5%, 0.063 W, 0402	0402	CRCW040233K0JNED	Vishay-Dale
RT2	1		Thermistor, DPY0002A (X1SON-2)	DPY0002A	PTC1131DPY	Texas Instruments
RT6	1	10k	Thermistor NTC, 10.0k ohm, 1%, 0402	0402	NCP15XH103F03RC	MuRata
S1	1		Switch, Slide, SPDT, 0.2A, GULL, 12V, SMD	SMD, 3-Leads, Body 8.5x3.5mm, Pitch 2.5mm	CL-SB-12B-01T	Copal Electronics
SW0, SW1, SW2, SW3	4		Switch, SPST-NO, Off-Mom, 0.05A, 12VDC, SMD	3.9x2.9mm	PTS820 J20M SMTR LFS	C&K Components
TP1, TP2, TP3, TP4	4		Natural PC Test Point Brass, SMT	Natural PC Test Point Brass, SMT	S2761-46R	Harwin
U1	1		Micropower 150-mA Low-Noise Ultra-Low-Dropout Regulator in SOT-23 and DSBGA Packages, DBV0005A (SOT-23-5)	DBV0005A	LP2985AIM5X-3.0/NOPB	Texas Instruments
U2	1		ESD-Protection Array for High-Speed Data Interfaces, 4 Channels, -40 to +85 degC, 6-pin SON (DRY), Green (RoHS & no Sb/Br)	DRY0006A	TPD4E004DRYR	Texas Instruments
U3	1		25 MHz Mixed Signal Microcontroller with 128 KB Flash, 8192 B SRAM and 47 GPIOs, -40 to 85 degC, 64-pin QFN (RGC), Green (RoHS & no Sb/Br)	RGC0064B	MSP430F5528IRGCR	Texas Instruments

Table 3. EVM Bill of Material (continued)

Designator	Quantity	Value	Description	PackageReference	PartNumber	Manufacturer
U4	1		High-Accuracy, Low-Power, Digital Temperature Sensor with SMBus and Two-Wire Serial Interface, DRV0006A (WSON-6)	DRV0006A	TMP116AIDRVR	Texas Instruments
Y1	1		Resonator, 4 MHz, 39pF SMD	4.5x1.2x2 mm	CSTCR4M00G15L99-R0	MuRata
FID1, FID2, FID3	0		Fiducial mark. There is nothing to buy or mount.	N/A	N/A	N/A
J2, J3, J5	0		Header, 2.54mm, 4x2, Gold, TH	Header, 2.54mm, 4x2, TH	TSW-104-08-L-D	Samtec
J4, J6	0		Header, 100mil, 5x2, Gold, TH	5x2 Header	TSW-105-07-G-D	Samtec
R7	0	0	RES, 0, 5%, 0.063 W, 0402	0402	CRCW04020000Z0ED	Vishay-Dale
RT1, RT5	0		Thermistor, LPG0002A (TO-92-2)	LPG0002A	PTC1131LPG	Texas Instruments
RT4, RT8	0		Thermistor, 0201	0201	PTC11310201	Texas Instruments

IMPORTANT NOTICE AND DISCLAIMER

TI PROVIDES TECHNICAL AND RELIABILITY DATA (INCLUDING DATASHEETS), DESIGN RESOURCES (INCLUDING REFERENCE DESIGNS), APPLICATION OR OTHER DESIGN ADVICE, WEB TOOLS, SAFETY INFORMATION, AND OTHER RESOURCES “AS IS” AND WITH ALL FAULTS, AND DISCLAIMS ALL WARRANTIES, EXPRESS AND IMPLIED, INCLUDING WITHOUT LIMITATION ANY IMPLIED WARRANTIES OF MERCHANTABILITY, FITNESS FOR A PARTICULAR PURPOSE OR NON-INFRINGEMENT OF THIRD PARTY INTELLECTUAL PROPERTY RIGHTS.

These resources are intended for skilled developers designing with TI products. You are solely responsible for (1) selecting the appropriate TI products for your application, (2) designing, validating and testing your application, and (3) ensuring your application meets applicable standards, and any other safety, security, or other requirements. These resources are subject to change without notice. TI grants you permission to use these resources only for development of an application that uses the TI products described in the resource. Other reproduction and display of these resources is prohibited. No license is granted to any other TI intellectual property right or to any third party intellectual property right. TI disclaims responsibility for, and you will fully indemnify TI and its representatives against, any claims, damages, costs, losses, and liabilities arising out of your use of these resources.

TI's products are provided subject to TI's Terms of Sale (www.ti.com/legal/termsofsale.html) or other applicable terms available either on ti.com or provided in conjunction with such TI products. TI's provision of these resources does not expand or otherwise alter TI's applicable warranties or warranty disclaimers for TI products.

Mailing Address: Texas Instruments, Post Office Box 655303, Dallas, Texas 75265
Copyright © 2018, Texas Instruments Incorporated

STANDARD TERMS FOR EVALUATION MODULES

1. *Delivery:* TI delivers TI evaluation boards, kits, or modules, including any accompanying demonstration software, components, and/or documentation which may be provided together or separately (collectively, an "EVM" or "EVMs") to the User ("User") in accordance with the terms set forth herein. User's acceptance of the EVM is expressly subject to the following terms.
 - 1.1 EVMs are intended solely for product or software developers for use in a research and development setting to facilitate feasibility evaluation, experimentation, or scientific analysis of TI semiconductor products. EVMs have no direct function and are not finished products. EVMs shall not be directly or indirectly assembled as a part or subassembly in any finished product. For clarification, any software or software tools provided with the EVM ("Software") shall not be subject to the terms and conditions set forth herein but rather shall be subject to the applicable terms that accompany such Software
 - 1.2 EVMs are not intended for consumer or household use. EVMs may not be sold, sublicensed, leased, rented, loaned, assigned, or otherwise distributed for commercial purposes by Users, in whole or in part, or used in any finished product or production system.
2. *Limited Warranty and Related Remedies/Disclaimers:*
 - 2.1 These terms do not apply to Software. The warranty, if any, for Software is covered in the applicable Software License Agreement.
 - 2.2 TI warrants that the TI EVM will conform to TI's published specifications for ninety (90) days after the date TI delivers such EVM to User. Notwithstanding the foregoing, TI shall not be liable for a nonconforming EVM if (a) the nonconformity was caused by neglect, misuse or mistreatment by an entity other than TI, including improper installation or testing, or for any EVMs that have been altered or modified in any way by an entity other than TI, (b) the nonconformity resulted from User's design, specifications or instructions for such EVMs or improper system design, or (c) User has not paid on time. Testing and other quality control techniques are used to the extent TI deems necessary. TI does not test all parameters of each EVM. User's claims against TI under this Section 2 are void if User fails to notify TI of any apparent defects in the EVMs within ten (10) business days after delivery, or of any hidden defects with ten (10) business days after the defect has been detected.
 - 2.3 TI's sole liability shall be at its option to repair or replace EVMs that fail to conform to the warranty set forth above, or credit User's account for such EVM. TI's liability under this warranty shall be limited to EVMs that are returned during the warranty period to the address designated by TI and that are determined by TI not to conform to such warranty. If TI elects to repair or replace such EVM, TI shall have a reasonable time to repair such EVM or provide replacements. Repaired EVMs shall be warranted for the remainder of the original warranty period. Replaced EVMs shall be warranted for a new full ninety (90) day warranty period.
3. *Regulatory Notices:*
 - 3.1 *United States*
 - 3.1.1 *Notice applicable to EVMs not FCC-Approved:*

FCC NOTICE: This kit is designed to allow product developers to evaluate electronic components, circuitry, or software associated with the kit to determine whether to incorporate such items in a finished product and software developers to write software applications for use with the end product. This kit is not a finished product and when assembled may not be resold or otherwise marketed unless all required FCC equipment authorizations are first obtained. Operation is subject to the condition that this product not cause harmful interference to licensed radio stations and that this product accept harmful interference. Unless the assembled kit is designed to operate under part 15, part 18 or part 95 of this chapter, the operator of the kit must operate under the authority of an FCC license holder or must secure an experimental authorization under part 5 of this chapter.
 - 3.1.2 *For EVMs annotated as FCC – FEDERAL COMMUNICATIONS COMMISSION Part 15 Compliant:*

CAUTION

This device complies with part 15 of the FCC Rules. Operation is subject to the following two conditions: (1) This device may not cause harmful interference, and (2) this device must accept any interference received, including interference that may cause undesired operation.

Changes or modifications not expressly approved by the party responsible for compliance could void the user's authority to operate the equipment.

FCC Interference Statement for Class A EVM devices

NOTE: This equipment has been tested and found to comply with the limits for a Class A digital device, pursuant to part 15 of the FCC Rules. These limits are designed to provide reasonable protection against harmful interference when the equipment is operated in a commercial environment. This equipment generates, uses, and can radiate radio frequency energy and, if not installed and used in accordance with the instruction manual, may cause harmful interference to radio communications. Operation of this equipment in a residential area is likely to cause harmful interference in which case the user will be required to correct the interference at his own expense.

FCC Interference Statement for Class B EVM devices

NOTE: This equipment has been tested and found to comply with the limits for a Class B digital device, pursuant to part 15 of the FCC Rules. These limits are designed to provide reasonable protection against harmful interference in a residential installation. This equipment generates, uses and can radiate radio frequency energy and, if not installed and used in accordance with the instructions, may cause harmful interference to radio communications. However, there is no guarantee that interference will not occur in a particular installation. If this equipment does cause harmful interference to radio or television reception, which can be determined by turning the equipment off and on, the user is encouraged to try to correct the interference by one or more of the following measures:

- Reorient or relocate the receiving antenna.
- Increase the separation between the equipment and receiver.
- Connect the equipment into an outlet on a circuit different from that to which the receiver is connected.
- Consult the dealer or an experienced radio/TV technician for help.

3.2 Canada

3.2.1 For EVMs issued with an Industry Canada Certificate of Conformance to RSS-210 or RSS-247

Concerning EVMs Including Radio Transmitters:

This device complies with Industry Canada license-exempt RSSs. Operation is subject to the following two conditions:

(1) this device may not cause interference, and (2) this device must accept any interference, including interference that may cause undesired operation of the device.

Concernant les EVMs avec appareils radio:

Le présent appareil est conforme aux CNR d'Industrie Canada applicables aux appareils radio exempts de licence. L'exploitation est autorisée aux deux conditions suivantes: (1) l'appareil ne doit pas produire de brouillage, et (2) l'utilisateur de l'appareil doit accepter tout brouillage radioélectrique subi, même si le brouillage est susceptible d'en compromettre le fonctionnement.

Concerning EVMs Including Detachable Antennas:

Under Industry Canada regulations, this radio transmitter may only operate using an antenna of a type and maximum (or lesser) gain approved for the transmitter by Industry Canada. To reduce potential radio interference to other users, the antenna type and its gain should be so chosen that the equivalent isotropically radiated power (e.i.r.p.) is not more than that necessary for successful communication. This radio transmitter has been approved by Industry Canada to operate with the antenna types listed in the user guide with the maximum permissible gain and required antenna impedance for each antenna type indicated. Antenna types not included in this list, having a gain greater than the maximum gain indicated for that type, are strictly prohibited for use with this device.

Concernant les EVMs avec antennes détachables

Conformément à la réglementation d'Industrie Canada, le présent émetteur radio peut fonctionner avec une antenne d'un type et d'un gain maximal (ou inférieur) approuvé pour l'émetteur par Industrie Canada. Dans le but de réduire les risques de brouillage radioélectrique à l'intention des autres utilisateurs, il faut choisir le type d'antenne et son gain de sorte que la puissance isotrope rayonnée équivalente (p.i.r.e.) ne dépasse pas l'intensité nécessaire à l'établissement d'une communication satisfaisante. Le présent émetteur radio a été approuvé par Industrie Canada pour fonctionner avec les types d'antenne énumérés dans le manuel d'usage et ayant un gain admissible maximal et l'impédance requise pour chaque type d'antenne. Les types d'antenne non inclus dans cette liste, ou dont le gain est supérieur au gain maximal indiqué, sont strictement interdits pour l'exploitation de l'émetteur.

3.3 Japan

3.3.1 *Notice for EVMs delivered in Japan:* Please see http://www.tij.co.jp/lstds/ti_ja/general/eStore/notice_01.page 日本国内に輸入される評価用キット、ボードについては、次のところをご覧ください。
http://www.tij.co.jp/lstds/ti_ja/general/eStore/notice_01.page

3.3.2 *Notice for Users of EVMs Considered "Radio Frequency Products" in Japan:* EVMs entering Japan may not be certified by TI as conforming to Technical Regulations of Radio Law of Japan.

If User uses EVMs in Japan, not certified to Technical Regulations of Radio Law of Japan, User is required to follow the instructions set forth by Radio Law of Japan, which includes, but is not limited to, the instructions below with respect to EVMs (which for the avoidance of doubt are stated strictly for convenience and should be verified by User):

1. Use EVMs in a shielded room or any other test facility as defined in the notification #173 issued by Ministry of Internal Affairs and Communications on March 28, 2006, based on Sub-section 1.1 of Article 6 of the Ministry's Rule for Enforcement of Radio Law of Japan,
2. Use EVMs only after User obtains the license of Test Radio Station as provided in Radio Law of Japan with respect to EVMs, or
3. Use of EVMs only after User obtains the Technical Regulations Conformity Certification as provided in Radio Law of Japan with respect to EVMs. Also, do not transfer EVMs, unless User gives the same notice above to the transferee. Please note that if User does not follow the instructions above, User will be subject to penalties of Radio Law of Japan.

【無線電波を送信する製品の開発キットをお使いになる際の注意事項】 開発キットの中には技術基準適合証明を受けていないものがあります。技術適合証明を受けていないものご使用に際しては、電波法遵守のため、以下のいずれかの措置を取っていただく必要がありますのでご注意ください。

1. 電波法施行規則第6条第1項第1号に基づく平成18年3月28日総務省告示第173号で定められた電波暗室等の試験設備でご使用いただく。
2. 実験局の免許を取得後ご使用いただく。
3. 技術基準適合証明を取得後ご使用いただく。

なお、本製品は、上記の「ご使用にあたっての注意」を譲渡先、移転先に通知しない限り、譲渡、移転できないものとします。

上記を遵守頂けない場合は、電波法の罰則が適用される可能性があることをご留意ください。日本テキサス・インスツルメンツ株式会社
東京都新宿区西新宿 6 丁目 2 4 番 1 号
西新宿三井ビル

3.3.3 *Notice for EVMs for Power Line Communication:* Please see http://www.tij.co.jp/lstds/ti_ja/general/eStore/notice_02.page
電力線搬送波通信についての開発キットをお使いになる際の注意事項については、次のところをご覧ください。 http://www.tij.co.jp/lstds/ti_ja/general/eStore/notice_02.page

3.4 *European Union*

3.4.1 *For EVMs subject to EU Directive 2014/30/EU (Electromagnetic Compatibility Directive):*

This is a class A product intended for use in environments other than domestic environments that are connected to a low-voltage power-supply network that supplies buildings used for domestic purposes. In a domestic environment this product may cause radio interference in which case the user may be required to take adequate measures.

4 *EVM Use Restrictions and Warnings:*

4.1 EVMS ARE NOT FOR USE IN FUNCTIONAL SAFETY AND/OR SAFETY CRITICAL EVALUATIONS, INCLUDING BUT NOT LIMITED TO EVALUATIONS OF LIFE SUPPORT APPLICATIONS.

4.2 User must read and apply the user guide and other available documentation provided by TI regarding the EVM prior to handling or using the EVM, including without limitation any warning or restriction notices. The notices contain important safety information related to, for example, temperatures and voltages.

4.3 *Safety-Related Warnings and Restrictions:*

4.3.1 User shall operate the EVM within TI's recommended specifications and environmental considerations stated in the user guide, other available documentation provided by TI, and any other applicable requirements and employ reasonable and customary safeguards. Exceeding the specified performance ratings and specifications (including but not limited to input and output voltage, current, power, and environmental ranges) for the EVM may cause personal injury or death, or property damage. If there are questions concerning performance ratings and specifications, User should contact a TI field representative prior to connecting interface electronics including input power and intended loads. Any loads applied outside of the specified output range may also result in unintended and/or inaccurate operation and/or possible permanent damage to the EVM and/or interface electronics. Please consult the EVM user guide prior to connecting any load to the EVM output. If there is uncertainty as to the load specification, please contact a TI field representative. During normal operation, even with the inputs and outputs kept within the specified allowable ranges, some circuit components may have elevated case temperatures. These components include but are not limited to linear regulators, switching transistors, pass transistors, current sense resistors, and heat sinks, which can be identified using the information in the associated documentation. When working with the EVM, please be aware that the EVM may become very warm.

4.3.2 EVMs are intended solely for use by technically qualified, professional electronics experts who are familiar with the dangers and application risks associated with handling electrical mechanical components, systems, and subsystems. User assumes all responsibility and liability for proper and safe handling and use of the EVM by User or its employees, affiliates, contractors or designees. User assumes all responsibility and liability to ensure that any interfaces (electronic and/or mechanical) between the EVM and any human body are designed with suitable isolation and means to safely limit accessible leakage currents to minimize the risk of electrical shock hazard. User assumes all responsibility and liability for any improper or unsafe handling or use of the EVM by User or its employees, affiliates, contractors or designees.

4.4 User assumes all responsibility and liability to determine whether the EVM is subject to any applicable international, federal, state, or local laws and regulations related to User's handling and use of the EVM and, if applicable, User assumes all responsibility and liability for compliance in all respects with such laws and regulations. User assumes all responsibility and liability for proper disposal and recycling of the EVM consistent with all applicable international, federal, state, and local requirements.

5. *Accuracy of Information:* To the extent TI provides information on the availability and function of EVMs, TI attempts to be as accurate as possible. However, TI does not warrant the accuracy of EVM descriptions, EVM availability or other information on its websites as accurate, complete, reliable, current, or error-free.

6. *Disclaimers:*
- 6.1 EXCEPT AS SET FORTH ABOVE, EVMS AND ANY MATERIALS PROVIDED WITH THE EVM (INCLUDING, BUT NOT LIMITED TO, REFERENCE DESIGNS AND THE DESIGN OF THE EVM ITSELF) ARE PROVIDED "AS IS" AND "WITH ALL FAULTS." TI DISCLAIMS ALL OTHER WARRANTIES, EXPRESS OR IMPLIED, REGARDING SUCH ITEMS, INCLUDING BUT NOT LIMITED TO ANY EPIDEMIC FAILURE WARRANTY OR IMPLIED WARRANTIES OF MERCHANTABILITY OR FITNESS FOR A PARTICULAR PURPOSE OR NON-INFRINGEMENT OF ANY THIRD PARTY PATENTS, COPYRIGHTS, TRADE SECRETS OR OTHER INTELLECTUAL PROPERTY RIGHTS.
- 6.2 EXCEPT FOR THE LIMITED RIGHT TO USE THE EVM SET FORTH HEREIN, NOTHING IN THESE TERMS SHALL BE CONSTRUED AS GRANTING OR CONFERRING ANY RIGHTS BY LICENSE, PATENT, OR ANY OTHER INDUSTRIAL OR INTELLECTUAL PROPERTY RIGHT OF TI, ITS SUPPLIERS/LICENSORS OR ANY OTHER THIRD PARTY, TO USE THE EVM IN ANY FINISHED END-USER OR READY-TO-USE FINAL PRODUCT, OR FOR ANY INVENTION, DISCOVERY OR IMPROVEMENT, REGARDLESS OF WHEN MADE, CONCEIVED OR ACQUIRED.
7. *USER'S INDEMNITY OBLIGATIONS AND REPRESENTATIONS.* USER WILL DEFEND, INDEMNIFY AND HOLD TI, ITS LICENSORS AND THEIR REPRESENTATIVES HARMLESS FROM AND AGAINST ANY AND ALL CLAIMS, DAMAGES, LOSSES, EXPENSES, COSTS AND LIABILITIES (COLLECTIVELY, "CLAIMS") ARISING OUT OF OR IN CONNECTION WITH ANY HANDLING OR USE OF THE EVM THAT IS NOT IN ACCORDANCE WITH THESE TERMS. THIS OBLIGATION SHALL APPLY WHETHER CLAIMS ARISE UNDER STATUTE, REGULATION, OR THE LAW OF TORT, CONTRACT OR ANY OTHER LEGAL THEORY, AND EVEN IF THE EVM FAILS TO PERFORM AS DESCRIBED OR EXPECTED.
8. *Limitations on Damages and Liability:*
- 8.1 *General Limitations.* IN NO EVENT SHALL TI BE LIABLE FOR ANY SPECIAL, COLLATERAL, INDIRECT, PUNITIVE, INCIDENTAL, CONSEQUENTIAL, OR EXEMPLARY DAMAGES IN CONNECTION WITH OR ARISING OUT OF THESE TERMS OR THE USE OF THE EVMS , REGARDLESS OF WHETHER TI HAS BEEN ADVISED OF THE POSSIBILITY OF SUCH DAMAGES. EXCLUDED DAMAGES INCLUDE, BUT ARE NOT LIMITED TO, COST OF REMOVAL OR REINSTALLATION, ANCILLARY COSTS TO THE PROCUREMENT OF SUBSTITUTE GOODS OR SERVICES, RETESTING, OUTSIDE COMPUTER TIME, LABOR COSTS, LOSS OF GOODWILL, LOSS OF PROFITS, LOSS OF SAVINGS, LOSS OF USE, LOSS OF DATA, OR BUSINESS INTERRUPTION. NO CLAIM, SUIT OR ACTION SHALL BE BROUGHT AGAINST TI MORE THAN TWELVE (12) MONTHS AFTER THE EVENT THAT GAVE RISE TO THE CAUSE OF ACTION HAS OCCURRED.
- 8.2 *Specific Limitations.* IN NO EVENT SHALL TI'S AGGREGATE LIABILITY FROM ANY USE OF AN EVM PROVIDED HEREUNDER, INCLUDING FROM ANY WARRANTY, INDEMNITY OR OTHER OBLIGATION ARISING OUT OF OR IN CONNECTION WITH THESE TERMS, , EXCEED THE TOTAL AMOUNT PAID TO TI BY USER FOR THE PARTICULAR EVM(S) AT ISSUE DURING THE PRIOR TWELVE (12) MONTHS WITH RESPECT TO WHICH LOSSES OR DAMAGES ARE CLAIMED. THE EXISTENCE OF MORE THAN ONE CLAIM SHALL NOT ENLARGE OR EXTEND THIS LIMIT.
9. *Return Policy.* Except as otherwise provided, TI does not offer any refunds, returns, or exchanges. Furthermore, no return of EVM(s) will be accepted if the package has been opened and no return of the EVM(s) will be accepted if they are damaged or otherwise not in a resalable condition. If User feels it has been incorrectly charged for the EVM(s) it ordered or that delivery violates the applicable order, User should contact TI. All refunds will be made in full within thirty (30) working days from the return of the components(s), excluding any postage or packaging costs.
10. *Governing Law:* These terms and conditions shall be governed by and interpreted in accordance with the laws of the State of Texas, without reference to conflict-of-laws principles. User agrees that non-exclusive jurisdiction for any dispute arising out of or relating to these terms and conditions lies within courts located in the State of Texas and consents to venue in Dallas County, Texas. Notwithstanding the foregoing, any judgment may be enforced in any United States or foreign court, and TI may seek injunctive relief in any United States or foreign court.

IMPORTANT NOTICE AND DISCLAIMER

TI PROVIDES TECHNICAL AND RELIABILITY DATA (INCLUDING DATASHEETS), DESIGN RESOURCES (INCLUDING REFERENCE DESIGNS), APPLICATION OR OTHER DESIGN ADVICE, WEB TOOLS, SAFETY INFORMATION, AND OTHER RESOURCES "AS IS" AND WITH ALL FAULTS, AND DISCLAIMS ALL WARRANTIES, EXPRESS AND IMPLIED, INCLUDING WITHOUT LIMITATION ANY IMPLIED WARRANTIES OF MERCHANTABILITY, FITNESS FOR A PARTICULAR PURPOSE OR NON-INFRINGEMENT OF THIRD PARTY INTELLECTUAL PROPERTY RIGHTS.

These resources are intended for skilled developers designing with TI products. You are solely responsible for (1) selecting the appropriate TI products for your application, (2) designing, validating and testing your application, and (3) ensuring your application meets applicable standards, and any other safety, security, or other requirements. These resources are subject to change without notice. TI grants you permission to use these resources only for development of an application that uses the TI products described in the resource. Other reproduction and display of these resources is prohibited. No license is granted to any other TI intellectual property right or to any third party intellectual property right. TI disclaims responsibility for, and you will fully indemnify TI and its representatives against, any claims, damages, costs, losses, and liabilities arising out of your use of these resources.

TI's products are provided subject to TI's Terms of Sale (www.ti.com/legal/termsofsale.html) or other applicable terms available either on ti.com or provided in conjunction with such TI products. TI's provision of these resources does not expand or otherwise alter TI's applicable warranties or warranty disclaimers for TI products.

Mailing Address: Texas Instruments, Post Office Box 655303, Dallas, Texas 75265
Copyright © 2018, Texas Instruments Incorporated