



ClimaSys

Catalogue

Thermal management system



schneider-electric.com

Life Is On

Schneider
Electric



Green Premium™

Endorsing the most eco-friendly products in the industry



Green Premium™ Product

Green Premium is the only label that allows you to effectively develop and promote an environmental policy whilst preserving your business efficiency. This ecolabel guarantees compliance with the most up-to-date environmental regulations, but it does more than this.

Over 75% of Schneider Electric manufactured products have been awarded the Green Premium ecolabel



Discover what we mean by green...

Check your products!

Schneider Electric's Green Premium ecolabel is committed to offering transparency, by disclosing extensive and reliable information related to the environmental impact of its products:

RoHS

Schneider Electric products are subject to RoHS requirements at a worldwide level, even for the many products that are not required to comply with the terms of the regulation. Compliance certificates are available for products that fulfil the criteria of this European initiative, which aims to eliminate hazardous substances.

REACH

Schneider Electric applies the strict REACH regulation on its products at a worldwide level, and discloses extensive information concerning the presence of SVHC (Substances of Very High Concern) in all of these products.

PEP: Product Environmental Profile

Schneider Electric publishes the most complete set of environmental data, including carbon footprint and energy consumption data for each of the lifecycle phases on all of its products, in compliance with the ISO 14025 PEP ecopassport program. PEP is especially useful for monitoring, controlling, saving energy, and/or reducing carbon emissions.







EoLI: End of Life Instructions

Available at the click of a button, these instructions provide:

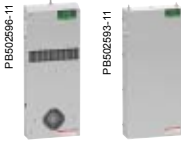
- Recyclability rates for Schneider Electric products.
- Guidance to mitigate personnel hazards during the dismantling of products and before recycling operations.
- Parts identification for recycling or for selective treatment, to mitigate environmental hazards/ incompatibility with standard recycling processes.

Thermal management system

ClimaSys

	Presentation	4	A
	Thermal problems in an enclosure Overview of thermal management solutions		
	ClimaSys CV Ventilation systems	8	B
	New ClimaSys CE Exchangers	28	C
	New ClimaSys CU Cooling Units	39	D
	ClimaSys CRS Ultra thin resistance heaters	56	E
	ClimaSys CR Resistance Heaters	58	F
	New ClimaSys CC Thermal Control	63	G
	New ClimaSys DT Dataloggers	66	H
	Thermal balance	70	I
	Spare parts	72	J

Thermal management system Presentation



Thermal problems in enclosures

Evolution of the electrical switchboard

An electrical switchboard is an assembly formed of the following components:

- The enclosure;
- Switchgear and controlgear;
- Electrical conductors; and
- Miscellaneous functions (indications, controls, information processing).

It has evolved in three directions:

- Enclosures increasingly made of insulating materials;
- Switchgear and controlgear incorporating more and more electronics which concentrates a growing number of functions in an increasingly small volume;
- An increasingly high filling rate.

Industrial safety studies, a concept which covers:

- The safety of personnel and equipment;
- The availability of electric power;

show that this is one of the critical points of all industrial and service-sector activities. Its operation must therefore be perfectly under control; and this control must concern not only the operation of its components but also their operating conditions in a given environment.

Temperature and humidity in the enclosure

Analysis of the malfunctions and stoppages of an electrical installation shows that they are mostly of thermal origin: temperature too high or too low inside the enclosure.

The rise in the average temperature, which may exceed the limits tolerated by the equipment, can be explained by the changes in electrical switchboards:

- Use of insulating materials for the enclosure, which limits heat removal;
- -Widespread adoption of electronics and a higher filling rate increase the temperature.

This overheating may concern only certain areas: hot spots.

The excessively low temperature is due to installation of the electrical switchboard in a very cold environment. It can cause the formation of condensation, a phenomenon which is harmful for the equipment.

Consequences

The presence of humidity or an excessively high temperature inside the enclosure can cause numerous malfunctions:

- Nuisance tripping of protective devices;
- Fire inside the enclosure;
- Burns for the users;
- Premature equipment ageing;

The consequence of these malfunctions is an increase in the installation's operating costs:

- Maintenance costs,
- Costs entailed by stoppage of the installation.



Solution: thermal management

Objective

The thermal management solution adopted shall:

- Maintain the temperature and the humidity level inside the enclosure at values corresponding to normal operation of the equipment.
- Establish a uniform temperature to prevent hot spots.

Choice of solution

The products constituting the thermal management solution are chosen by producing the thermal balance of the installation. This comprises 2 parts:

- Thermal balance inside the enclosure;
- Evaluation of the climatic conditions (temperature, humidity level) or environmental conditions (pollution) of the place in which the electrical switchboard is located.



The Schneider Electric solutions

With the ClimaSys range Schneider Electric proposes a comprehensive offer meeting all needs:

- Cooling
- Heating
- Regulating
- Homogenizing

Schneider Electric also proposes a thermal design software program, ProClima, which produces the thermal balance and proposes one or more thermal management solutions.

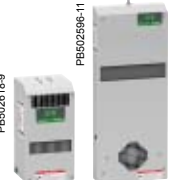
Cooling

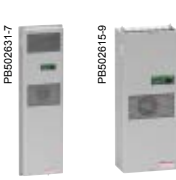
- 
> **Forced ventilation systems**
PB501021-35
- 
> **Air-air exchangers**
PB502618-9
PB502696-11
- 
> **Air-water exchangers**
PB502693-11
PB502606-16
- 
> **Cooling units**
PB502631-7
PB502615-9

Heating

- 
> **Resistance heaters**
PB501026-12
PB501027-12
PB501028-9
PB502042-4

Controlling

- 
> **Thermal control accessories**
PB501030-28



Thermal software

- 
PB500071-33

Thermal management system

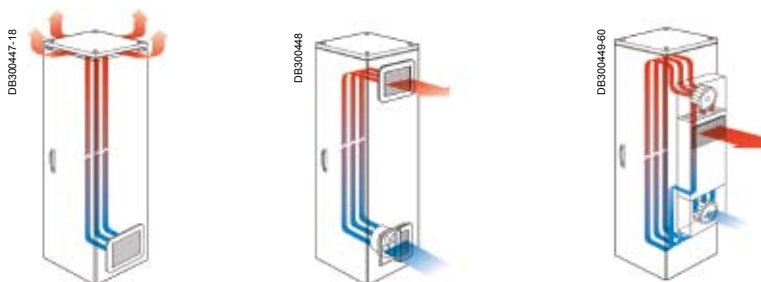
Solutions overview



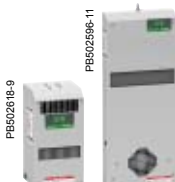



	Homogenize		Cool		
Solution	Stirring	Natural ventilation	Forced ventilation	Air-air exchanger	
Description	Stirring fan inside the enclosure.	Air circulation achieved by installing grids (side or roof-mounted) with or without filter, or by elevating the roof.	A fan (with or without filter) sucks fresh air from outside to inside the enclosure, thereby creating a slight overpressure which causes removal of the hot air through an outlet grid. The air circulation homogenizes the temperature and the overpressure prevents dust from entering. Side or roof mounting. Can be combined with a thermostat.	Cooling system provided with an aluminum exchange coil to separate the internal and external air circuits, two centrifugal fans to blow in the air circuits, and a thermostat to regulate the temperature in the enclosure. Side or roof mounting.	
Use	Prevent hot spots.	Low power to be dissipated. Dusty environment.	High power to be dissipated. Dusty and non-hazardous environment. Prevent hot spots.	Medium power to be dissipated. Corrosive environment (food processing industry). Relatively cold environment (about 25°C).	
Temperature conditions *	None	$T_d > T_a + 5^\circ\text{C}$	$T_d > T_a + 5^\circ\text{C}$ $3^\circ\text{C} < T_a \leq 35^\circ\text{C}$	$T_d > T_a + 5^\circ\text{C}$	
Independent internal and external air circuits?	No	No	No	Yes	
Advantages	<ul style="list-style-type: none"> Uniform temperature inside the enclosure. 	<ul style="list-style-type: none"> Very economical solution No maintenance Easy, fast installation. 	<ul style="list-style-type: none"> Economical solution Easy maintenance Easy, fast installation Uniform temperature inside the enclosure Guaranteed level of protection: IP55 (IP54 for roof models). 	<ul style="list-style-type: none"> Easy maintenance (no filter) Far lower maintenance frequency than for fans IP55 guaranteed. 	
Disadvantages		<ul style="list-style-type: none"> Low power dissipated Reduction in the degree of protection IP Risk of ingress of particles and dust if no filter. 	<ul style="list-style-type: none"> Internal temperature always higher than the external temperature Maintenance required: change of filters. 	<ul style="list-style-type: none"> Internal temperature always higher than the external temperature. 	
Illustration		 Outlet grids	 Fans	 Air-air exchangers	

* T_a = ambient temperature (outside the enclosure)

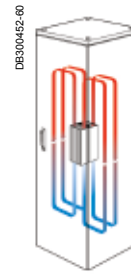
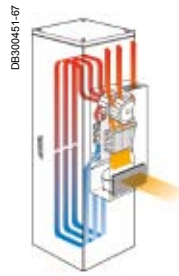
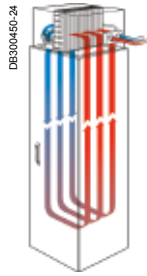
T_d = desired temperature inside the enclosure

Thermal management system Solutions overview



Cool		Heat	
<p>Air-water exchanger</p> <p>Cooling system provided with an exchange coil supplied with cold water and separated from the internal air circuit, a centrifugal fan for the air circuit, and a thermostat to regulate the temperature in the enclosure. Side or roof mounting.</p>	<p>Cooling unit</p> <p>Operates like a heat pump: A condenser removes to the ambient air the calories absorbed by an evaporator. The air inside the enclosure is thus cooled and dried. Side, floor or roof mounting.</p>	<p>Heating resistor</p> <p>The heating resistors prevent the formation of condensation and ensure an ideal temperature inside the enclosure.</p>	
<p>Large quantity of heat to be removed. Difficult environments (cement plant, production lines, greasy workshops, etc.) or humid environments (sewage plant, bottling factory, etc.). Do not discharge calories into the environment.</p>	<p>Highly polluted environment but which permits the use of a filter for external protection of the cooling unit. Do not use ambient air in the cooling circuit.</p>	<p>To heat the inside of the enclosure and prevent condensation.</p>	
<p>Ta > Td</p>	<p>Ta > Td and Ta ≤ 55°C</p>	<p>Ta < Td</p>	
<p>Yes</p>	<p>Yes</p>	<p>-</p>	
<ul style="list-style-type: none"> Internal temperature independent of the external temperature Security system against any leaks Calories dissipated outside Guaranteed level of protection: IP55 (IP54 for roof models). 	<ul style="list-style-type: none"> Internal temperature independent of the external temperature Uniform temperature inside the enclosure. Guaranteed level of protection: IP54 for roof and floor models, IP55 for side models and the SLIM range Use of an ecological gas. 	<ul style="list-style-type: none"> Small size (1.6 mm thick for the ultra-thin version) Low surface temperature (< 70°C for insulated version, 75°C for aluminum version) Uniform temperature inside the enclosure with the version equipped with a fan. 	
<ul style="list-style-type: none"> There must be a cold water circuit of stable temperature and flow rate Installation of special piping. 	<ul style="list-style-type: none"> Installation of a system from removal of condensation water from the evaporator Maintenance required: change of filters. 		
 <p>Air-water exchangers</p>	 <p>Cooling units</p>	 <p>Heating resistors</p>	

Thermal management system

Introduction

> Large range of fans:

flow rate efficiency, high protection rating, quick installation and easier maintenance to secure all the applications.

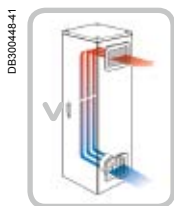

Ventilation Systems

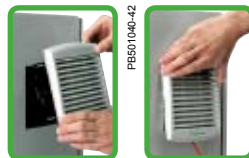

Easy installation

Quick installation

- Safe, reliable fixing with the assisted fixing device and the system of multi-thickness fixing-clips.
- Fixing also possible using screws.
- Easy to invert.
- To operate as extractors, all the motors can be inverted by simply removing four screws.



Easy maintenance

Quick filter replacement

Quick, easy and safe replacement of the filter installed in the fan, even during operation.



Quality of the components

Selection of the motors

- Improved flow rate and longer service life.
- Large range of input voltages available on all the motors delivered as standard, with alternating 50/60 Hz or direct current.



Certifications

- UL



Optimised flow rate: average increase of 50 %

- Maximum use of surface.
- Minimum loss of pressure.

Thermal management system

Introduction

High protection rating: IP54 as standard



1 - Fixing guide

- To centre the body of the fan on the wall of enclosure.
- To correct machining faults.
- To facilitate the correct operation of the fixing "clips".

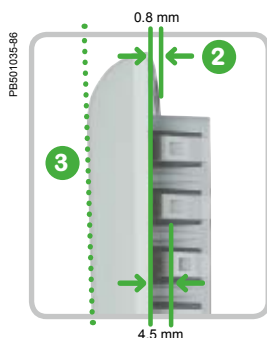

2 - Multi-thickness fixing-clips

- To guarantee easy and reliable fixing of the ventilation system.
- With a thickness of 0.8 to 4.5 mm, with no fixings.

3 - Inclined profile of the grille

- To protect the filter against vertical spraying:
 - each slat is protected by the slat above it,
 - the external dimensions remain small.



4 - IP54-55

A patented system allows the evacuation of water absorbed by the filter, in particular during high-pressure spraying.



5 - Hot-fitted sealing gasket

The polyurethane gasket, hot cast, guarantees a long-lasting seal.



6 - Effective system for retaining the filter

The system for holding the synthetic filter in the cavity of the filter holder guarantees a protection rating of IP54, in the most difficult conditions.

Thermal management system

Characteristics

Ventilation Systems

Forced ventilation

Characteristics

Material

Colour

Conditions of use

Ingress protection rating

Installation

Options

Free flow rate with standard filter (m ³ /h)	Flow rate with outlet grille(s) (m ³ /h)		Voltage range (nominal voltage)	Absorbed power (max. intensity)	Noise level	External dimensions (cut-out)	Weight	Operating temperature	Max. static pressure
	1	2							
38 (50 Hz) 39 (60 Hz)	25 (50 Hz) 26 (60 Hz)	33 (50 Hz)	150 V...250 V (230 V)	4.5/4.8 W (0.16/0.17 A)	40/41 dB (A)	137 x 117 x 49 (92 x 92)	0.220 kg	-10...+70°C	29 Pa
38 (50 Hz) 39 (60 Hz)	27 (50 Hz) 28 (60 Hz)	35 (50 Hz)	75 V...125 V (115 V)	3.3/3.5 W (0.16/0.16 A)	40/41 dB (A)	137 x 117 x 49 (92 x 92)	0.220 kg	-10...+70°C	29 Pa
58	39	47 (50 Hz)	10 V...27.6 V (24 V DC)	3.6 W (0.18 A)	40/41 dB (A)	137 x 117 x 49 (92 x 92)	0.230 kg	-10...+70°C	29 Pa
44	34	41 (50 Hz)	36 V...56 V (48 V DC)	3.6 W (70 mA)	40/41 dB (A)	137 x 117 x 49 (92 x 92)	0.230 kg	-10...+70°C	29 Pa
85 (50 Hz) 98 (60 Hz)	63 (50 Hz) 72 (60 Hz)	71 (50 Hz)	175 V...253 V (230 V)	17/15 W (0.121/0.097 A)	46/49 dB (A)	170 x 150 x 62 (125)	0.780 kg	-20...+60°C	50 Pa
79 (50 Hz) 92 (60 Hz)	65 (50 Hz) 74 (60 Hz)	73 (50 Hz)	75 V...126 V (115 V)	16/15 W (0.207/0.179 A)	46/49 dB (A)	170 x 150 x 62 (125)	0.780 kg	-20...+60°C	50 Pa
80	57	77 (50 Hz)	10 V...27.6 V (24 V DC)	7.6 W (0.30 A)	46/49 dB (A)	170 x 150 x 62 (125)	0.480 kg	-10...+70°C	50 Pa
79	59	68 (50 Hz)	25 V...55.2 V (48 V DC)	8 W (0.173 A)	46/49 dB (A)	170 x 150 x 62 (125)	0.480 kg	-10...+70°C	50 Pa
165 (50 Hz) 193 (60 Hz)	153 (50 Hz) 171 (60 Hz)	161 (50 Hz) 175 (60 Hz)	175 V...253 V (230 V)	16.3/14.3 W (0.12/0.94 A)	50/51 dB (A)	268 x 248 x 104 (223 x 223)	1.140 kg	-20...+60°C	50 Pa
164 (50 Hz) 193 (60 Hz)	153 (50 Hz) 171 (60 Hz)	161 (50 Hz) 179 (60 Hz)	75 V...126 V (115 V)	15.5/14.4 W (0.20/0.18 A)	50/51 dB (A)	268 x 248 x 104 (223 x 223)	1.140 kg	-20...+60°C	50 Pa
188	171	179	10 V...27.6 V (24 V DC)	8 W (0.3 A)	50/51 dB (A)	268 x 248 x 104 (223 x 223)	0.810 kg	-10...+70°C	50 Pa
193	171	179	25 V...55.2 V (48 V DC)	8.7 W (0.18 A)	50/51 dB (A)	268 x 248 x 104 (223 x 223)	0.810 kg	-10...+70°C	50 Pa
302 (50 Hz) 350 (60 Hz)	260 (50 Hz) 307 (60 Hz)	268 (50 Hz)	145 V...253 V (230 V)	36/37 W (0.17/0.16 A)	55/56 dB (A)	268 x 248 x 116 (223 x 223)	1.3 kg	-10...+70°C	158 Pa
302 (50 Hz) 350 (60 Hz)	263 (50 Hz) 307 (60 Hz)	271 (50 Hz)	75 V...126 V (115 V)	36/36 W (0.35/0.32 A)	55/56 dB (A)	268 x 248 x 116 (223 x 223)	1.3 kg	-10...+70°C	158 Pa
262	221	229 (50 Hz)	12 V...30 V (24 V DC)	13 W (0.53 A)	55/56 dB (A)	268 x 248 x 103.4 (223 x 223)	1.1 kg	-10...+70°C	158 Pa
247	210	218 (50 Hz)	25 V...60 V (48 V DC)	11 W (0.24 A)	55/56 dB (A)	268 x 248 x 103.4 (223 x 223)	1.1 kg	-10...+70°C	158 Pa
562 (50 Hz) 586 (60 Hz)	473 (50 Hz) 477 (60 Hz)	481 (50 Hz)	207 V...244 V (230 V)	68/85 W (0.52/0.370 A)	59/59 dB (A)	336 x 316 x 161 (291 x 291)	3.2 kg	-15...+60°C	140 Pa
582 (50 Hz) 586 (60 Hz)	485 (50 Hz) 477 (60 Hz)	494 (50 Hz)	103 V...122 V (115 V)	65/83 W (0.60/0.72 A)	59/59 dB (A)	336 x 316 x 161 (291 x 291)	3.2 kg	-15...+60°C	140 Pa
838 (50 Hz) 803 (60 Hz)	718 (50 Hz) 568 (60 Hz)	728 (50 Hz)	207 V...244 V (230 V)	150/195 W (0.65/0.85 A)	76/75 dB (A)	336 x 316 x 162 (291 x 291)	4.1 kg	-15...+60°C	170 Pa
983 (50 Hz) 944 (60 Hz)	843 (50 Hz) 642 (60 Hz)	854 (50 Hz)	103 V...122 V (115 V)	145/182 W (1.279/1.6 A)	78/77 dB (A)	336 x 316 x 162 (291 x 291)	4.1 kg	-15...+60°C	170 Pa
931 (50 Hz) 803 (60 Hz)	798 (50 Hz) 568 (60 Hz)	809 (50 Hz)	396 V...466 V (400 V)	126/126 W (0.226/0.232 A)	77/75 dB (A)	336 x 316 x 162 (291 x 291)	4.1 kg	-15...+60°C	170 Pa

Thermal management system

Characteristics



Forced ventilation fan 38 m³/h	Forced ventilation fan 85 m³/h	Forced ventilation fan 165 m³/h	Forced ventilation fan 300 m³/h	Forced ventilation fan 560-850 m³/h
-----------------------------------	-----------------------------------	------------------------------------	------------------------------------	--

The fans comprise an axial motor, a protective housing on the front and rear surfaces and a filter designed to retain dust particles. This filter can be replaced during operation without risk of contact with the rotating element.

Injected thermoplastic (ASA PC), self-extinguishing according to UL 94 V-0

RAL 7035 as standard, with the option of RAL 7032

- The external temperature must not exceed 35°C and must be more than 5°C lower than the temperature wanted in the enclosure
- The filters that equip the fans must be cleaned and replaced regularly
- The ambient air must be relatively clean and overfrequent filter replacement should be avoided
- Bear in mind the pressure losses caused by the outlet element (grille with filter, ventilation louvre or simple opening) when determining the fan flow rate
- Storage Temperature: -40...+ 70°C

IP54

The cut-out template supplied with the device avoids the need for marking and protects the surface of the enclosure during handling

The device can be equipped with a filter that provides even more efficient protection for your sensitive facilities against dust particles

B

Type of connection				
by cable	by faston (1)	by faston (1)	by faston (1)	by terminal block
NSYCVF38M230PF*	-	-	-	-
NSYCVF38M115PF*	-	-	-	-
NSYCVF38M24DPF	-	-	-	-
NSYCVF38M48DPF	-	-	-	-
-	NSYCVF85M230PF	-	-	-
-	NSYCVF85M115PF	-	-	-
-	NSYCVF85M24DPF	-	-	-
-	NSYCVF85M48DPF	-	-	-
-	-	NSYCVF165M230PF	-	-
-	-	NSYCVF165M115PF	-	-
-	-	NSYCVF165M24DPF	-	-
-	-	NSYCVF165M48DPF	-	-
-	-	-	NSYCVF300M230PF	-
-	-	-	NSYCVF300M115PF	-
-	-	-	NSYCVF300M24DPF	-
-	-	-	NSYCVF300M48DPF	-
-	-	-	-	NSYCVF560M230PF
-	-	-	-	NSYCVF560M115PF
-	-	-	-	NSYCVF850M230PF
-	-	-	-	NSYCVF850M115PF
-	-	-	-	NSYCVF850M400PF

(1) Fan models with connection type (F) are delivered with the connection cord included (2 metres).
 * Warning: the fan NSYCVF38M230PF & NSYCVF38M115PF MUST NOT be connected to a power conversion module, an inverter or UPS type of power supply!

Thermal management system

Dimensions

Fan 38 m³/h

Dimensions

Flow curves

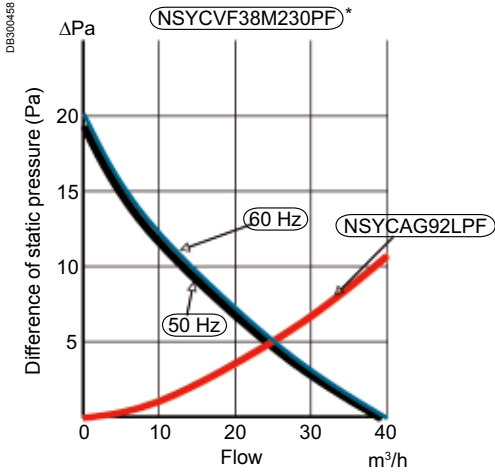

* Warning: the fan **NSYCVF38M230PF** MUST NOT be connected to a power conversion module, an inverter or UPS type of power supply!

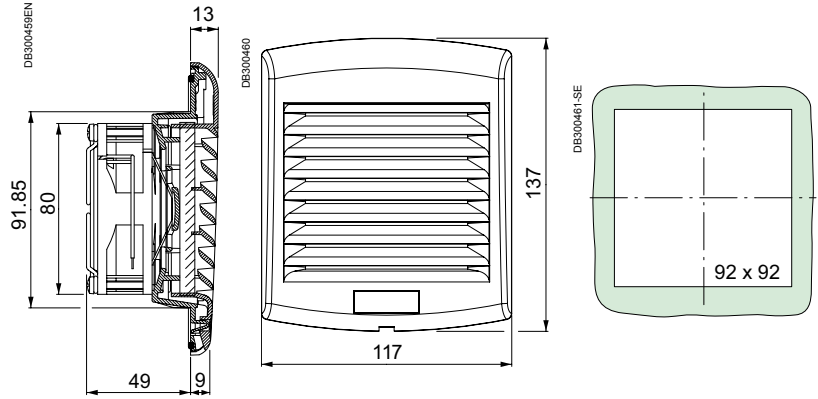

Fan 85 m³/h

Dimensions

Flow curves

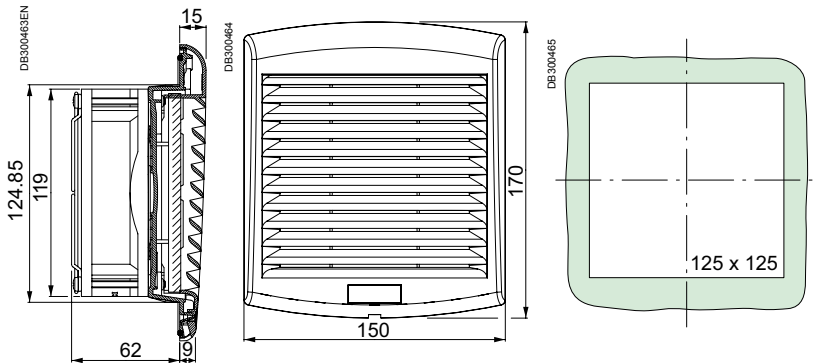
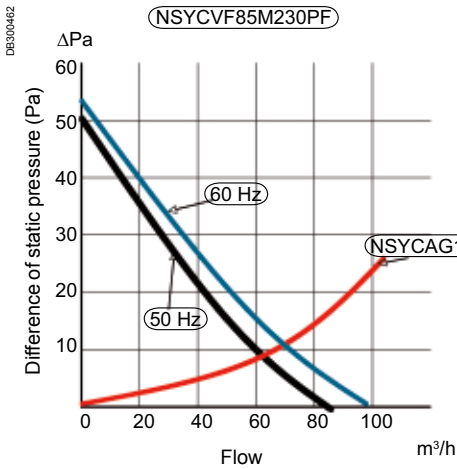

Fan 165 m³/h

Dimensions

Flow curves

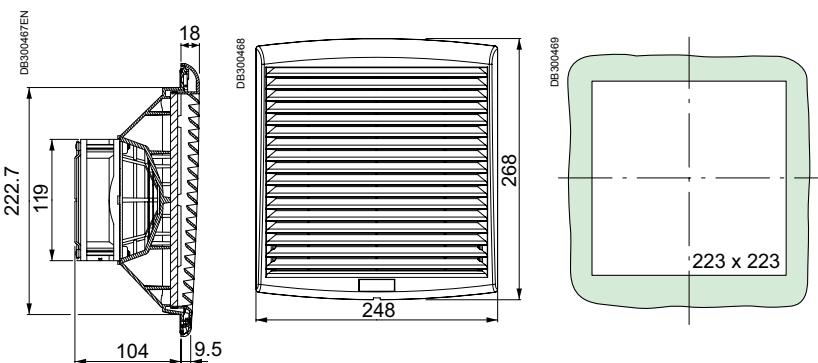
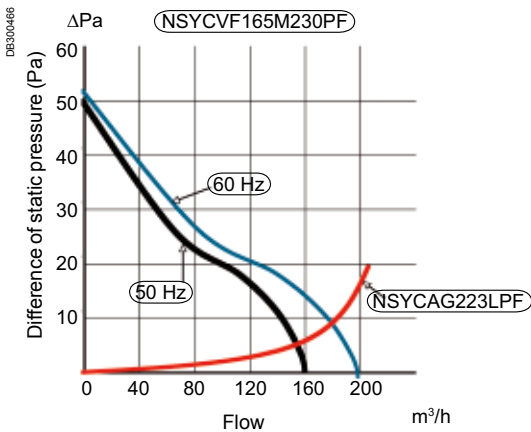

Thermal management system

Dimensions

Flow curves

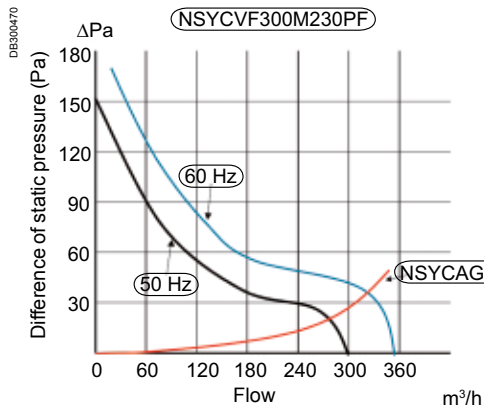

Fan 300 m³/h

Dimensions

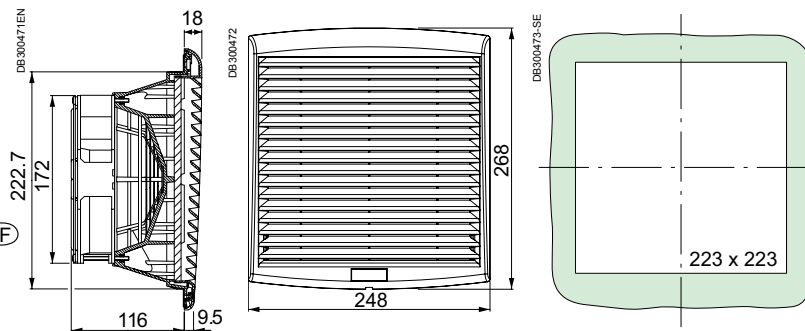

B

Flow curves

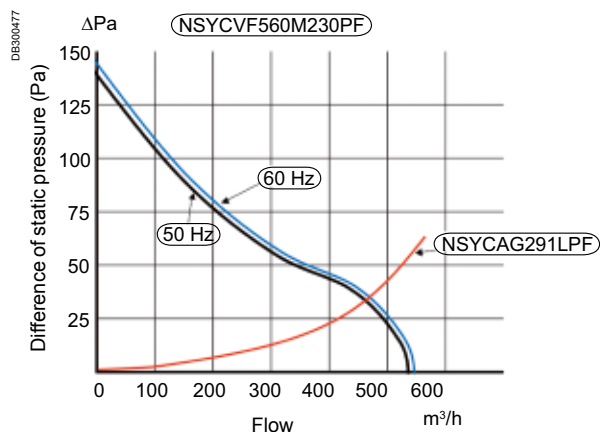

Fan 560-850 m³/h

Dimensions

A	B	References
225	160.5	NSYCVF560M230PF NSYCVF560M115PF
280	162	NSYCVF850M230PF NSYCVF850M115PF

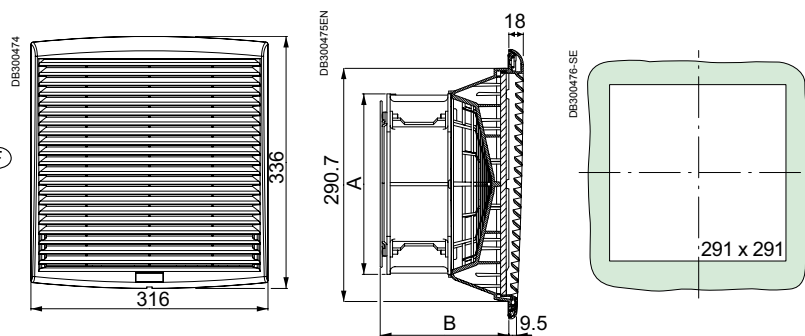
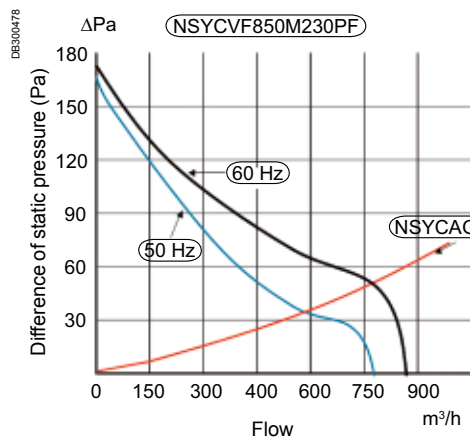

Thermal management system

Accessories

Ventilation Systems



RAL 7035



RAL 7032

Characteristics				IP54 outlet grilles	
				Delivered with G2 M1 synthetic standard filter.	
Material				Cover for changing the colour of the standard grille RAL 7035 to RAL 7032.	
Colour				Injected thermoplastic (ASA PC), self-extinguishing according to UL 94	
Ingress protection rating				RAL 7035	
				IP54	
Height (mm)	Width (mm)	Depth (mm)	Cut-out (mm)	References	
137	117	13	92 x 92	NSYCAG92LPF	NSYCAG92LPC
170	150	15	125 x 125	NSYCAG125LPF	NSYCAG125LPC
268	248	18	223 x 223	NSYCAG223LPF	NSYCAG223LPC
336	316	18	291 x 291	NSYCAG291LPF	NSYCAG291LPC

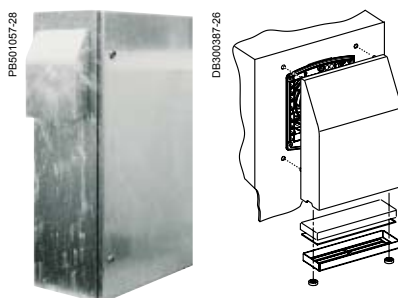

Characteristics				Covers IP55	Spare filter for cover	Fan	Grille	
				This solution protects the fan or the grille from any direct sprays. The cover is the preferred solution to guarantee the following: <ul style="list-style-type: none"> □ an efficient air flow for cooling, □ IP55 rating. 	-	-	-	
Material				2 materials available: <ul style="list-style-type: none"> □ sheet-steel painted with epoxy-polyester resin (RAL 7035) for outdoor applications □ stainless-steel 304L for food and beverage applications 	-	-	-	
Ingress protection rating				IP55	-	-	-	
Mechanical protection rating				IK10	-	-	-	
Certifications				UL	-	-	-	
Installation				Double insulation maintained if installed in an insulated enclosure. The cover is placed over the fan or the grille with a filter located at the bottom of the cover to prevent the entry of particles. Easy access to the filter: only two screws needed. When mounting: remove the external part of the fan or the grille as well as the filter.	-	-	-	
Supply				It is necessary to order 1 fan + 1 grille + 2 covers to have a complete system	-	-	-	
Flow rate (m³/h)* with cover		Dimensions (mm)		References				
Free	With 1 outlet grille	External	Cut-out	Sheet-steel painted for outdoor applications RAL 7035	Stainless-steel 304L	Emb. mineur 5 p	RAL 7035	RAL 7035
74	53	240 x 180 x 60	125 x 125	NSYCAP125LZF	NSYCAP125LXF	NSYCAF125L55	NSYCVF85M230PF	NSYCAG125LPC
110	82	350 x 305 x 80	223 x 223	NSYCAP223LZF	NSYCAP223LXF	NSYCAF223L55	NSYCVF165M230PF	NSYCAG223LPC
165	123	350 x 305 x 80	223 x 223	NSYCAP223LZF	NSYCAP223LXF	NSYCAF223L55	NSYCVF300M230PF	NSYCAG223LPC
316	265	430 x 373 x 105	291 x 291	NSYCAP291LZF	NSYCAP291LXF	NSYCAF291L55	NSYCVF560M230PF	NSYCAG291LPC
502	430	430 x 373 x 105	291 x 291	NSYCAP291LZF	NSYCAP291LXF	NSYCAF291L55	NSYCVF850M230PF	NSYCAG291LPC

* Values given for a fan powered at 230 V. For other voltages, the values are similar.

Thermal management system Accessories

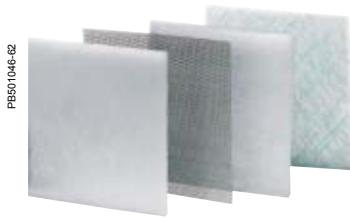

PB501046-02

B

Filters							
G2 M1 synthetic standard filters		Filters for greasy environments G2 M1		G3 M1 synthetic fine filters		Stainless-steel anti-insect filters	
For fans and grilles.							
-							
-							
-							
Pack.	References	Pack.	References	Pack.	References	Pack.	References
5	NSYCAF92	-	-	-	-	1	NSYCAF92M
5	NSYCAF125	5	NSYCAF125O	5	NSYCAF125T	1	NSYCAF125M
5	NSYCAF223	5	NSYCAF223O	5	NSYCAF223T	1	NSYCAF223M
5	NSYCAF291	5	NSYCAF291O	5	NSYCAF291T	1	NSYCAF291M

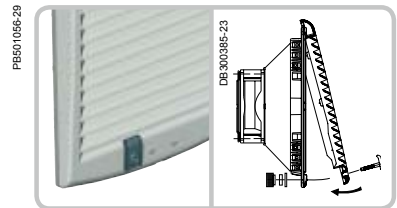

PB501056-29

DB 300385-23

Characteristics	Anti-vandalism kit
	Prevents the grille from being opened from the outside. The unlocking thumbwheel is accessed from the inside of the wall-mounting enclosure.
Colour	RAL 7011 (same material as the grille: ASA PC)
Minor packaging	Reference
2	NSYCAAPV

Thermal management system Accessories

Ventilation system Heavy duty

New



Characteristics	Fanbox	Filter	Roof filter for fanbox	IP55 HD Metal Grille	Anti-vandalism kit for HD metal grille										
	<ul style="list-style-type: none"> Free flow rate: 550 m³/h (50/60 Hz). Minimal depth inside the enclosure (90 mm). Allows multiple cooling architectures (see page 18 et 19). 	Replacement G3 M1 type synthetic filter for HD metal grille. <ul style="list-style-type: none"> Dimensions: 223 x 223 mm. 	Roof G2 round synthetic filter designed to cover the fanbox. Covers completely the fanbox and helps to protect it from dust and humidity. Mandatory for fanbox installation in the Roof ventilation module for IP55 configurations.	Slim grille (35 mm external depth). Includes a G3 M1 filter.	Fixings that help to prevent to open the grille from the outside with standard tools (EN 1627-1630:2011 Class 2).										
Material	Plastic	-	-	Steel with anti-corrosive coating	Steel with anti-corrosive coating										
Finish	-	-	-	Structured finish, 100 % polyester powder	-										
Colour	RAL 7016 dark grey	-	-	RAL 7035 grey	-										
Ingress protection rating	-	-	-	IP55	-										
Mechanical protection rating	-	-	-	IK10	-										
Supply	1 (grille not included)	5	1	1 grille delivered with G3 M1 type synthetic filter (223 x 223mm) and fixings.	1 kit										
	<table border="1"> <thead> <tr> <th>Voltage</th> <th>References</th> </tr> </thead> <tbody> <tr> <td>24 V DC</td> <td>NSYCVF550M24FB</td> </tr> <tr> <td>24 V DC</td> <td>NSYCVF550M48FB</td> </tr> <tr> <td>115 V AC</td> <td>NSYCVF550M115FB</td> </tr> <tr> <td>230 V AC</td> <td>NSYCVF550M230FB</td> </tr> </tbody> </table>	Voltage	References	24 V DC	NSYCVF550M24FB	24 V DC	NSYCVF550M48FB	115 V AC	NSYCVF550M115FB	230 V AC	NSYCVF550M230FB	Reference	Reference	Reference	Reference
Voltage	References														
24 V DC	NSYCVF550M24FB														
24 V DC	NSYCVF550M48FB														
115 V AC	NSYCVF550M115FB														
230 V AC	NSYCVF550M230FB														
		NSYCAF223T	NSYCAF190	NSYCAG223LFHD	NSYCAAPVHD										

Thermal management system

Ventilation architectures

New

- ① IP55 metal grille
- ② Fanbox
- ③ Roof ventilated module
- ④ Ventilated plinths
- ⑤ IP54 grille

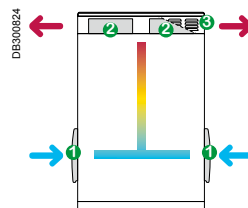
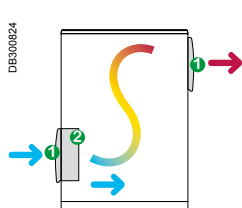

	S-Line				T-Line			
Architecture benefits	<ul style="list-style-type: none"> ■ Most common and competitive architecture ■ Maximum heat dissipation to extract 800 W-1000 W ■ ΔT° of 5°C ■ Easy access to mount-dismount fanbox ■ Air flow in horizontal axis 				<ul style="list-style-type: none"> ■ High capacity of extraction calories up to 1500 W ■ Noise level with 1 fan: 55 dB when installed inside the upper ventilation module ■ ΔT° of 5°C ■ Air flow in vertical axis 			
	IP55 metal grille		Fanbox		IP55 metal grille		Fanbox	Roof ventilation module
	Door	Side	Door	Side	Door	Side	(1 filter NSYCAF190 for each Fanbox)	

Polyester outdoor HD enclosure

References	Amount to be installed				Amount to be installed				References
NSYPHDT553	-	-	-	-	-	-	-	-	-
NSYPHDT553P	-	-	-	-	-	-	-	-	-
NSYPHDT753	-	-	-	-	-	-	-	-	-
NSYPHDT753P	1 to 2	-	1 to 2	-	1 to 2	-	-	-	-
NSYPHDZT774	-	1 to 2	-	1 to 2	-	1 to 2	1 to 2	1	NSYPCVR74HD
NSYPHDZT774P	1 to 2	1 to 2	1 to 2	1 to 2	1 to 2	1 to 2	1 to 2	1	NSYPCVR74HD
NSYPHDZT776	-	1 to 2	-	1 to 2	-	1 to 2	1 to 2	1	NSYPCVR76HD
NSYPHDZT776P	1 to 2	1 to 2	1 to 2	1 to 2	1 to 2	1 to 2	1 to 2	1	NSYPCVR76HD
NSYPHDZT1054	-	1	-	1	-	1	1	1	NSYPCVR54HD
NSYPHDZT1054P	1 to 2	1	1 to 2	1	1 to 2	1	1	1	NSYPCVR54HD
NSYPHDZT1074	-	1 to 2	-	1 to 2	-	1 to 2	1 to 2	1	NSYPCVR74HD
NSYPHDZT1074P	1 to 4	1 to 2	1 to 4	1 to 2	1 to 4	1 to 2	1 to 2	1	NSYPCVR74HD
NSYPHDZT12124	-	1 to 3	-	1 to 3	-	1 to 3	1 to 3	1	NSYPCVR124HD
NSYPHDZT12124P	1 to 4	1 to 3	1 to 4	1 to 3	1 to 4	1 to 3	1 to 3	1	NSYPCVR124HD
NSYPHDZT12126	-	1 to 3	-	1 to 3	-	1 to 3	1 to 3	1	NSYPCVR126HD
NSYPHDZT12126P	1 to 4	1 to 3	1 to 4	1 to 3	1 to 4	1 to 3	1 to 3	1	NSYPCVR126HD
NSYPHDZT1254	-	1	-	1	-	1	1	1	NSYPCVR54HD
NSYPHDZT1254P	1 to 3	1	1 to 3	1	1 to 3	1	1	1	NSYPCVR54HD
NSYPHDZT1274	-	1 to 2	-	1 to 2	-	1 to 2	1 to 2	1	NSYPCVR74HD
NSYPHDZT1274P	1 to 4	1 to 2	1 to 4	1 to 2	1 to 4	1 to 2	1 to 2	1	NSYPCVR74HD
NSYPHDZT1276	-	1 to 2	-	1 to 2	-	1 to 2	1 to 2	1	NSYPCVR76HD
NSYPHDZT1276P	1 to 4	1 to 2	1 to 4	1 to 2	1 to 4	1 to 2	1 to 2	1	NSYPCVR76HD
NSYPHDZT15124	-	1 to 3	-	1 to 3	-	1 to 3	1 to 3	1	NSYPCVR124HD
NSYPHDZT15124P	1 to 4	1 to 3	1 to 4	1 to 3	1 to 4	1 to 3	1 to 3	1	NSYPCVR124HD
NSYPHDZT15126	-	1 to 3	-	1 to 3	-	1 to 3	1 to 3	1	NSYPCVR126HD
NSYPHDZT15126P	1 to 4	1 to 3	1 to 4	1 to 3	1 to 4	1 to 3	1 to 3	1	NSYPCVR126HD
NSYPHDZT1574	-	1 to 2	-	1 to 2	-	1 to 2	1 to 2	1	NSYPCVR74HD
NSYPHDZT1574P	1 to 4	1 to 2	1 to 4	1 to 2	1 to 4	1 to 2	1 to 2	1	NSYPCVR74HD
NSYPHDZT1576	-	1 to 2	-	1 to 2	-	1 to 2	1 to 2	1	NSYPCVR76HD
NSYPHDZT1576P	1 to 4	1 to 2	1 to 4	1 to 2	1 to 4	1 to 2	1 to 2	1	NSYPCVR76HD
NSYPHDZT2074	-	1 to 2	-	1 to 2	-	1 to 2	1 to 2	1	NSYPCVR74HD
NSYPHDZT2074P	1 to 4	1 to 2	1 to 4	1 to 2	1 to 4	1 to 2	1 to 2	1	NSYPCVR74HD

Steel outdoor HD enclosure

References	Amount to be installed				Amount to be installed				References
NSYS3HD8630	1 to 2	-	1 to 2	-	1 to 2	-	-	-	-
NSYS3HD8840	1 to 2	1 to 2	1 to 2	1 to 2	1 to 2	1 to 2	1 to 2	1	NSYS3CVR84HD
NSYS3HD10640	1 to 2	1 to 2	1 to 2	1 to 2	1 to 2	1 to 2	1	1	NSYS3CVR64HD
NSYS3HD10840	1 to 4	1 to 2	1 to 4	1 to 2	1 to 4	1 to 2	1 to 2	1	NSYS3CVR84HD
NSYSFHD12640	1 to 3	1 to 3	1 to 3	1 to 3	1 to 3	1 to 3	1	1	NSYSFCVR64HD
NSYSFHD12660	1 to 3	1 to 3	1 to 3	1 to 3	1 to 3	1 to 3	1	1	NSYSFCVR66HD
NSYSFHD12840	1 to 4	1 to 3	1 to 4	1 to 3	1 to 4	1 to 3	1 to 2	1	NSYSFCVR84HD
NSYSFHD12860	1 to 4	1 to 3	1 to 4	1 to 3	1 to 4	1 to 3	1 to 2	1	NSYSFECA66HD
NSYSFHD16660	1 to 4	1 to 4	1 to 4	1 to 4	1 to 4	1 to 4	1	1	NSYSFCVR66HD
NSYSFHD16840	1 to 4	1 to 4	1 to 4	1 to 3	1 to 4	1 to 3	1 to 2	1	NSYSFCVR84HD
NSYSFHD16860	1 to 4	1 to 4	1 to 4	1 to 4	1 to 4	1 to 4	1 to 2	1	NSYSFECA66HD
NSYSFHD20840	1 to 4	1 to 4	1 to 4	1 to 4	1 to 4	1 to 4	1 to 2	1	NSYSFCVR84HD
NSYSFHD1212402D	1 to 4	1 to 3	1 to 4	1 to 2	1 to 4	1 to 2	1 to 3	1	NSYSFCVR124HD
NSYSFHD1212602D	1 to 4	1 to 3	1 to 4	1 to 3	1 to 4	1 to 2	1 to 3	1	NSYSFCVR126HD
NSYSFHD1612402D	1 to 4	1 to 4	1 to 4	1 to 3	1 to 4	1 to 3	1 to 3	1	NSYSFCVR124HD
NSYSFHD1612602D	1 to 4	1 to 4	1 to 4	1 to 3	1 to 4	1 to 3	1 to 3	1	NSYSFCVR126HD

Thermal management system

Ventilation architectures

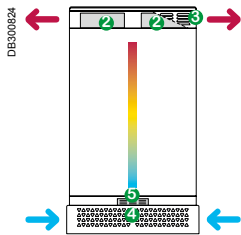

This table helps to configure thermal architectures, but it is highly recommended to use ProClima Software to ensure the right thermal solution according to the selected architecture.

B

I-Line

- Integrated architecture particularly suitable for public areas
- High capacity of extraction calories up to 1500 W
- Noise level with 1 fan: 55 dB when installed inside the upper ventilation module
- Good extraction flow rate power
- Air flow in vertical axis

IP54 outlet grille (NSYACAG223LPF + G3 filter NSYCAF223T)	Ventilated plinths	Fanbox (1 filter NSYCAF190 for each Fanbox)	Roof ventilation module
---	---------------------------	---	--------------------------------

Amount to be installed		References		Amount to be installed		References	
-	-	-	-	-	-	-	-
-	-	-	-	-	-	-	-
-	-	-	-	-	-	-	-
-	-	-	-	-	-	-	-
1 to 2	1	NSYZZ274VHD	-	1 to 2	1	NSYPCVR74HD	-
1 to 2	1	NSYZZ274VHD	-	1 to 2	1	NSYPCVR74HD	-
1 to 2	1	NSYZZ276VHD	-	1 to 2	1	NSYPCVR76HD	-
1 to 2	1	NSYZZ276VHD	-	1 to 2	1	NSYPCVR76HD	-
1	1	NSYZZ254VHD	-	1	1	NSYPCVR54HD	-
1	1	NSYZZ254VHD	-	1	1	NSYPCVR54HD	-
1 to 2	1	NSYZZ274VHD	-	1 to 2	1	NSYPCVR74HD	-
1 to 2	1	NSYZZ274VHD	-	1 to 2	1	NSYPCVR74HD	-
1 to 3	1	NSYZZ2124VHD	-	1 to 3	1	NSYPCVR124HD	-
1 to 3	1	NSYZZ2124VHD	-	1 to 3	1	NSYPCVR124HD	-
1 to 3	1	NSYZZ2126VHD	-	1 to 3	1	NSYPCVR126HD	-
1 to 3	1	NSYZZ2126VHD	-	1 to 3	1	NSYPCVR126HD	-
1	1	NSYZZ254VHD	-	1	1	NSYPCVR54HD	-
1	1	NSYZZ254VHD	-	1	1	NSYPCVR54HD	-
1 to 2	1	NSYZZ274VHD	-	1 to 2	1	NSYPCVR74HD	-
1 to 2	1	NSYZZ274VHD	-	1 to 2	1	NSYPCVR74HD	-
1 to 2	1	NSYZZ276VHD	-	1 to 2	1	NSYPCVR76HD	-
1 to 2	1	NSYZZ276VHD	-	1 to 2	1	NSYPCVR76HD	-
1 to 3	1	NSYZZ2124VHD	-	1 to 3	1	NSYPCVR124HD	-
1 to 3	1	NSYZZ2124VHD	-	1 to 3	1	NSYPCVR124HD	-
1 to 3	1	NSYZZ2126VHD	-	1 to 3	1	NSYPCVR126HD	-
1 to 3	1	NSYZZ2126VHD	-	1 to 3	1	NSYPCVR126HD	-
1 to 2	1	NSYZZ274VHD	-	1 to 2	1	NSYPCVR74HD	-
1 to 2	1	NSYZZ274VHD	-	1 to 2	1	NSYPCVR74HD	-
1 to 2	1	NSYZZ276VHD	-	1 to 2	1	NSYPCVR76HD	-
1 to 2	1	NSYZZ276VHD	-	1 to 2	1	NSYPCVR76HD	-
1 to 2	1	NSYZZ274VHD	-	1 to 2	1	NSYPCVR74HD	-
1 to 2	1	NSYZZ274VHD	-	1 to 2	1	NSYPCVR74HD	-

Amount to be installed		References		Amount to be installed		References	
1	1	NSYSPFVX6200	NSYSPSX3200	-	-	-	-
1 to 2	1	NSYSPFVX8200	NSYSPLVX4200	1 to 2	1	NSYS3CVR84HD	-
1	1	NSYSPFVX6200	NSYSPLVX4200	1	1	NSYS3CVR64HD	-
1	1	NSYSPFVX8200	NSYSPLVX4200	1 to 2	1	NSYS3CVR84HD	-
1	1	NSYSPFVX6200	NSYSPLVX4200	1	1	NSYSFCVR64HD	-
1	1	NSYSPFVX6200	NSYSPLVX6200	1	1	NSYSFCVR66HD	-
1 to 2	1	NSYSPFVX8200	NSYSPLVX4200	1 to 2	1	NSYSFCVR84HD	-
1 to 2	1	NSYSPFVX8200	NSYSPLVX6200	1 to 2	1	NSYSFECA66HD	-
1	1	NSYSPFVX6200	NSYSPLVX6200	1	1	NSYSFCVR66HD	-
1 to 2	1	NSYSPFVX8200	NSYSPLVX4200	1 to 2	1	NSYSFCVR84HD	-
1 to 2	1	NSYSPFVX8200	NSYSPLVX6200	1 to 2	1	NSYSFECA66HD	-
1 to 2	1	NSYSPFVX8200	NSYSPLVX4200	1 to 2	1	NSYSFCVR84HD	-
1 to 3	1	NSYSPFVX12200	NSYSPLVX4200	1 to 3	1	NSYSFCVR124HD	-
1 to 3	1	NSYSPFVX12200	NSYSPLVX6200	1 to 3	1	NSYSFCVR126HD	-
1 to 3	1	NSYSPFVX12200	NSYSPLVX4200	1 to 3	1	NSYSFCVR124HD	-
1 to 3	1	NSYSPFVX12200	NSYSPLVX6200	1 to 3	1	NSYSFCVR126HD	-

Thermal management system

Accessories

EMC ventilation Systems



Characteristics				EMC IP54 fan
Ingress protection rating				IP54
References				To effectively protect the equipment against electromagnetic disruptions, the EMC fan is equipped with: <ul style="list-style-type: none"> <input type="checkbox"/> a steel frame covering the plastic elements (self-extinguishing ABS according to standard UL94 V0), <input type="checkbox"/> a metal grille attached to the frame, <input type="checkbox"/> a beryllium gasket guaranteeing conductivity between the perimeter of the fan unit and the enclosure.
External dimensions (mm)	Cut-out (mm)	Flow rate (m³/h)	Voltage (V)	
145 x 145 x 70	126 x 126	61	230	NSY17990
252 x 252 x 97	224 x 224	156	230	NSY17991
320 x 320 x 150	292 x 292	480	230	NSY17992

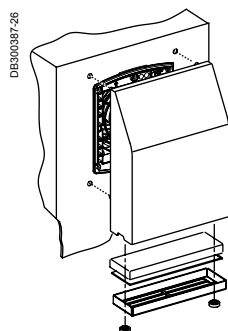

Characteristics				EMC IP55 cover
Colour				RAL 7035 grey
Ingress protection rating				IP55
Mechanical protection rating				IK10
Certifications				Absorption curve according to standard IEEE 299 1997 (UNE 50147-1)
Flow rate (m³/h)* with cover		Dimensions (mm)		References
Free	With 1 outlet grille	External	Cut-out	Sheet-steel painted for outdoor applications RAL 7035
74	53	240 x 180 x 60	125 x 125	NSYCAP125LE
110	82	350 x 305 x 80	223 x 223	NSYCAP223LE
165	123	350 x 305 x 80	223 x 223	NSYCAP223LE
316	265	430 x 373 x 105	291 x 291	NSYCAP291LE
502	430	430 x 373 x 105	291 x 291	NSYCAP291LE

* Values given for a fan powered at 230 V. For other voltages, the values are similar.



B

EMC IP54 outlet grille

Grille equipped with:

- a steel frame covering the plastic elements (self-extinguishing ABS according to standard UL 94 V-0),
- a metal grille attached to the frame,
- a beryllium gasket guaranteeing conductivity between the perimeter of the grille and the enclosure.

IP54

NSY17996

NSY17997

NSY17998

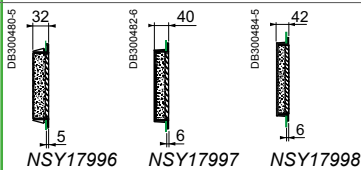

Dimensions of IP54 and EMC covers

Spare filter for cover	Fan	Grille
Minor pack. 5 p	RAL 7035	RAL 7035
NSYCAF125L55	NSYCVF85M230PF	NSYCAG125LPF
NSYCAF223L55	NSYCVF165M230PF	NSYCAG223LPF
NSYCAF223L55	NSYCVF300M230PF	NSYCAG223LPF
NSYCAF291L55	NSYCVF560M230PF	NSYCAG291LPF
NSYCAF291L55	NSYCVF850M230PF	NSYCAG291LPF

Dimensions (mm)								Cover references		
A	B	C	D	E	F	G	No. of fixing points	IP55		EMC
180	240	49	60	125	157	182	4	NSYCAP125LZF	NSYCAP125LXF	NSYCAP125LE
305	350	61	80	223	283	280	8	NSYCAP223LZF	NSYCAP223LXF	NSYCAP223LE
373	430	73	105	291	351	348	8	NSYCAP291LZF	NSYCAP291LXF	NSYCAP291LE

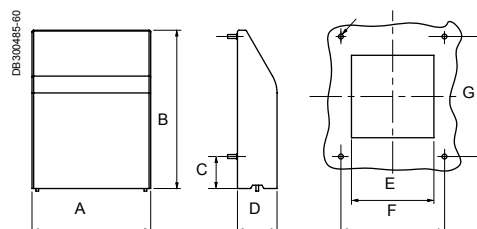

Thermal management system

Accessories

Fans by components



Fans

Free flow without filter or grille: 170 m³/h.

Two models according to the input voltage: 230 and 115 V, 50-60 Hz.

■ **Ingress protection rating:** IP20.

■ **Options:** IP20 outlet grille (ABS, black) and filter (black polyurethane foam).

Voltage (V)	Flow rate (m ³ /h)	References
115	65	NSYCVF65M115PF
230	65	NSYCVF65M230PF

Accessories

Dimensions (mm)	Description	References
124 x 124 x 11 mm	Outlet grille	NSYACG108LP
-	Filter	NSYCAF108

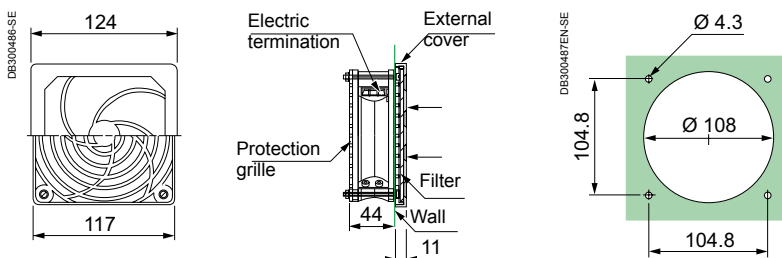

Ventilation kit

■ **Ingress protection rating:** IP33.

■ **Mechanical protection rating:** IK10.

■ **Overall flow rate:** 54 m³/h.

■ **Supply:**

- one 120 x 120 x 38 mm fan, 230 V - 50/60 Hz, free flow rate 170 m³/h, IP33/IK10,
- two 120 x 120 mm metal grilles, RAL 7035,
- two 115 x 98 mm anti-insect filters, stainless-steel 304L wire Ø 0.32 mm braided, 1.07-mm meshes,
- 1 power cord,
- the fixings required for installation.

Voltage (V)	Flow rate (m ³ /h)	Reference
230	54	NSYCVF54M230MM2

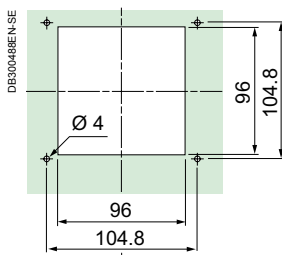

Top hood with fan
ref. NSYCVF575M230MF / NSYCVF570M115MF

Top hood with fan

Fan with hood, for floor-standing enclosures. A flow rate of 350 m³/h is obtained with an outlet grille ref. NSYACG291LPF, (cut-out 291 x 291 mm).

■ **Ingress protection rating:** IP54.

■ **Certification:** UL.

■ **Installation:** installation and removal from the outside.

■ **Electric power:** 85 W.

■ **Noise level:** 64 dB (A).

■ **Supply:** delivered with fixings and connection terminal block.

Voltage (V)	Flow rate* (m ³ /h)	Weight (kg)	References
115	570	5.8	NSYCVF570M115MF
230	575	5.8	NSYCVF575M230MF

* Flow rate measured without counter-pressure.

Thermal management system Accessories

Fans by components

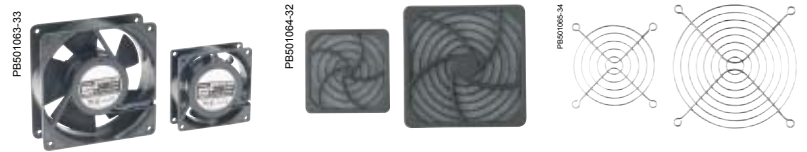

Characteristics					Fan motor	Outlet grille	Rear protective grille
					Turbine-type fan motor for ventilation/extraction.	Outlet filter kit for enclosure ventilation. For coupling to fans NSYCVF156M●●● and NSYCVF35M●●● .	Protective grille for enclosure fan motor. For coupling to fans NSYCVF156M●●● and NSYCVF35M●●● .
Flow rate (m³/h)	Voltage (V)	Absorbed power (W)	Noise level (dB)	External dimensions (mm)	References		
156	230/50-60	17/15	42	120 x 120 x 38	NSYCVF156M230	NSYCAG114LPF	NSYCVA114M
	120/50-60	17/15	42	120 x 120 x 38	NSYCVF156M115	NSYCAG114LPF	NSYCVA114M
35	230/50-60	16/14	32	80 x 80 x 25	NSYCVF35M230	NSYCAG78LPF	NSYCVA78M
	120/50-60	16/14	32	80 x 80 x 25	NSYCVF35M115	NSYCAG78LPF	-

B

PE501065-56



Fan connection cable

For coupling to the connection terminal of the fan motors.

Reference

NSYCVAC100

Circulating for internal forced convection



P8501067_63

Characteristics

Circulation fan

User protection according to DIN 31001.

Dimensions:

- Fan: 119 x 119 x 38 mm.
- Collar: length: 140 mm; fixing centre-to-centre distance: 130 mm.
- Installation on ball-bearing.

Supply

Flow rate (m ³ /h)	Voltage (V)	No.	Weight (kg)	P (W)	I (mA)	dB (A)	Depth (mm)	References
170 (1)	115	-	0.82	17	-	41	-	NSYCVF170M115
	230	-	0.82	17	-	41	-	NSYCVF170M230
300 (2)	230 (50-60 Hz)	-	-	37	-	-	-	-
486 (2)	230	3	3.3	45	300	43	208	-
972 (2)	230	6	5.5	90	600	44	330	-
1458 (2)	230	9	7.8	135	900	45	452	-
552 (2)	48 (3)	3	3.3	21.3	330	43	208	-

(1) Free flow.

(2) Flow rate measured without counter-pressure.

(3) Direct current.

Circulating

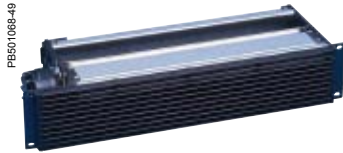

B

Tangential fan, 19" 2 U	Circulation fan, 19" 1 U
Air is sucked in from the front, filtered and forced vertically through the equipment.	Increases the speed of upward air circulation, in particular between trays with cards. Frontal operation LED. It is advisable to install slides, ref. NSYGB140 to guarantee optimal support of the fan.
Delivered without connection cord	Delivered without connection cord
-	-
-	-
NSYAVG2U300	-
-	NSYAVD1U480
-	NSYAVD1U970
-	NSYAVD1U1450
-	NSYAVD1U550M48

Thermal management system

Accessories

Natural airing



PB501072-54

Characteristics												Metal louvre plate, rectangular	
Material												Steel	
Finish												Painted with epoxy-polyester resin, textured RAL 7035 grey	
Ingress protection rating												IP20	
Installation												On the sides of the enclosure. Fixing by screws	
Supply												1 metal louvre and fixing elements	
Dimensions (mm)	A (mm)	B (mm)	C (mm)	D (mm)	E (mm)	F (mm)	G (mm)	H (mm)	R (mm)	Slot width (mm)	No. of slots	References	
-	144	62	36	110	-	-	110	46	10	-	-	NSYCAG110X46M	
-	208	90	72	94	190	-	180	62	18	-	-	NSYCAG180X62M	
-	244	90	72	130	226	-	216	62	18	-	-	NSYCAG216X62M	
-	345	118	100	231	327	115.5	317	90.5	30	-	-	NSYCAG317X91M	
-	345	148	130	231	327	115.5	317	120	30	-	-	NSYCAG317X120M	
-	445	148	130	267	427	148.5	417	120	30	-	-	NSYCAG417X120M	
120 x 120	95	104	104.8	-	-	-	-	-	90	-	5		
160 x 160	110	130	140	-	-	-	-	-	-	100	5		
220 x 220	190	170	200	-	-	-	-	-	-	180	5		

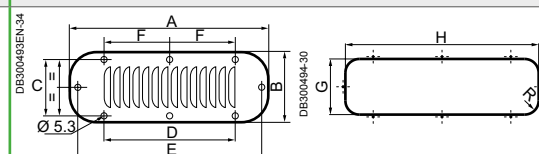

Roof accessories for natural airing



PB500095-30



PB500094-23



PB501062-30



PB501071-30

Characteristics		Roof elevators	Hood for natural airing
		Allow the roof to be raised, providing natural airing.	Natural airing device for coupling to the top of metal floor-standing enclosures. Solution for combining with the ventilation slots.
Material		Zinc-coated steel	Steel
Finish		-	Painted with epoxy-polyester resin, textured RAL 7035 grey
Ingress protection rating		-	IP54
Installation		They are screwed onto the structure, at the roof fixing point	Fixing to the top by means of caged nuts and special screws
Supply		4 elevators	1 hood for natural airing and fixing elements
Top elevation (mm) (H)	Weight (kg)	References	
26	-	NSYRE26	
60	-	NSYRE60	
-	4.6	-	
		NSYCAC228RMF	
		Spare filter	
		Reference	
		NSYCAF228R	

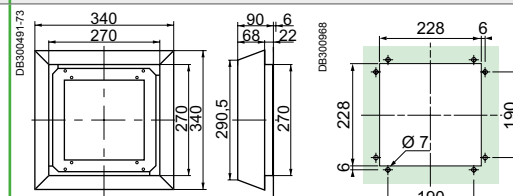
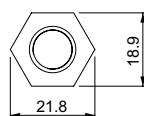
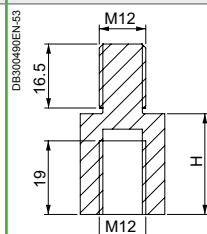



Natural airing

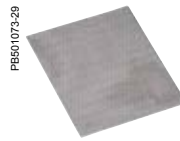

Metal louvre plate, square		Anti-insect filters for metal louvre plate, square		
-	-	Stainless-steel 304L Ø 0.32 mm wire mesh, of 1.07 mm, thickness 0.6 mm		
-	-	-		
IP23	-	IP33		
-	-	Between the enclosure and the metal louvre		
One metal louvre	-	One anti-insect filter		
		External dimensions (mm)	Weight (kg/m ²)	References
-	-	-	-	-
-	-	-	-	-
-	-	-	-	-
-	-	-	-	-
-	-	-	-	-
-	-	-	-	-
NSYCAG104X95LM	-	98 x 115	0.8	NSYCAF104X95X
NSYCAG130X110LM	-	133 x 158	0.8	NSYCAF130X110X
NSYCAG170X190LM	-	197 x 215	0.8	NSYCAF170X190X

B

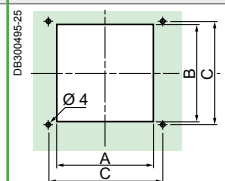

Other accessories for natural airing



Characteristics				Plastic ventilation louvres					Sealed anti-condensation valve
				Four models available according to IP rating, in vertical position.					Controls the pressure to avoid condensation following an internal temperature increase.
Material				-					PA6-V2, acrylic co-polymer membrane, water and oil repellent
Ingress protection rating				IP22	IP30/44 (1)	IP45	IP44	IP45	IP68
Temperature of use				-					-40... +105°C
Supply				References by unit. Order by multiples of 2 units (2, 4, 6, etc.)					-
Cut-out Ø (mm)	Permeability (2)	Pressure difference (3)	Minor pack.	References					
45.5	-	-	-	NSYCAG45LP	-	-	-	-	-
35	-	-	-	-	NSYCAG35LP	-	-	-	-
38	-	-	-	-	-	NSYCAG38LP	-	-	-
33	-	-	-	-	-	-	NSYCAG33LP	-	-
19	-	-	-	-	-	-	-	NSYCAG19LP	-
M12	16 litres/h	ΔP < 1 bar	10	-	-	-	-	-	NSYCAG12LPH1
	120 litres/h	ΔP < 0.1 bar	10	-	-	-	-	-	NSYCAG12LPH2

(1) According to installation in the Thalassa PLM wall-mounting enclosure.
 (2) Air flow for ΔP = 0.07 bar.
 (3) Condition for IP68.

Thermal management system

Introduction

New

> Choose **air-air exchangers** to take advantage of cooler ambient temperatures, such as food and beverage plants, to evacuate large amounts of heat while guaranteeing the independence of the internal and external air circuits.



Air-air exchangers: a new range energy efficient

PB502296C-48



Higher efficiency through improved design

With an updated external grill design, and by positioning cooling closer to critical equipment, such as speed drives, ClimaSys now provides **better flow**, **better cooling**, and **higher energy efficiency**.

PB500011SE



Simplicity saves you time

Our free ProClima thermal calculation software **makes specification simple and fast**. A new thermal solutions module integrates calculation for cooling and control devices, helping you maximize the energy efficiency of your systems.



Faster installation

A number of design improvements reduce installation time. Mounting requires single cut-outs and a minimum of screws. Wiring is accomplished with smart interconnects.



Protection

All side-mounted models are IP55 internally according to EN 60529.

DB406142



New certifications and declarations

- CE
- EAC

Thermal management system

Characteristics

New

Air-air exchangers



Characteristics	Side-mounting models			
	The air-air exchanger can be used in heavily polluted environments provided that the ambient temperature is at least 10°C lower than the internal temperature wanted.			
Material	Painted zinc-coated steel			
Colour	RAL 7035 grey			
Ingress protection rating	IP55			
Certifications	CE, EAC declaration			
Installation	Indoor			
Cooling characteristics				
Specific power	22 W/K	36 W/K	50 W/K	80 W/K
Air flow of the internal circuit (enclosure)	280 m³/h	570 m³/h	600 m³/h	1050 m³/h
Air flow of the external circuit (ambient)	280 m³/h	570 m³/h	600 m³/h	1050 m³/h
Thermostat type	-	Mechanical	Mechanical	Mechanical
Temperature setting range	-	+5 ... +60°C	+5 ... +60°C	+5 ... +60°C
Temperature range external circuit (ambient)	-5 ... +55°C	-5 ... +55°C	-5 ... +55°C	-5 ... +55°C
Type of fluid	Air	Air	Air	Air
Electric characteristics				
Input voltage	1 x 230 V / 50-60 Hz	1 x 230 V / 50-60 Hz	1 x 230 V / 50-60 Hz	1 x 230 V / 50-60 Hz
Rated Intensity	0.5 A	0.7 A	0.7 A	1.1 A
Power consumption absorbed	72 W	160 W	160 W	240 W
Thermal protection recommended (fuse)	T1 A	T1 A	T1 A	T2 A
Physical characteristics				
External dimensions (H x W x D)	413 x 189 x 149 mm	771 x 316 x 103 mm	771 x 316 x 103 mm	1260 x 317 x 148 mm
Protection degree IP internal /external	IP55 / IP22	IP55 / IP22	IP55 / IP22	IP55 / IP22
Noise level	59 dB	62 dB	62 dB	64 dB
Weight of unit	7 kg	10 kg	10 kg	17 kg
References				
	NSYCEA22E	NSYCEA36	NSYCEA50	NSYCEA80

Thermal management system

Dimensions

New

Air-air exchangers

Side-mounting models

NSYCEA22E

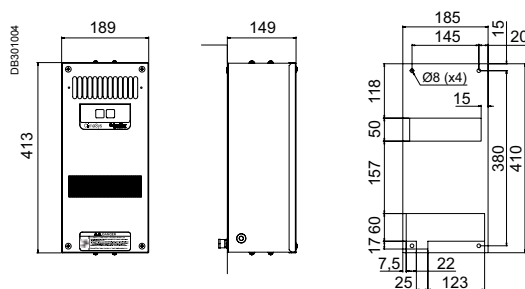

NSYCEA36 / NSYCEA50

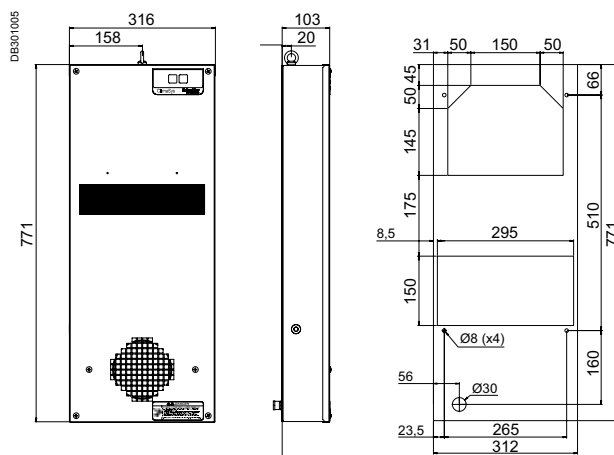

NSYCEA80

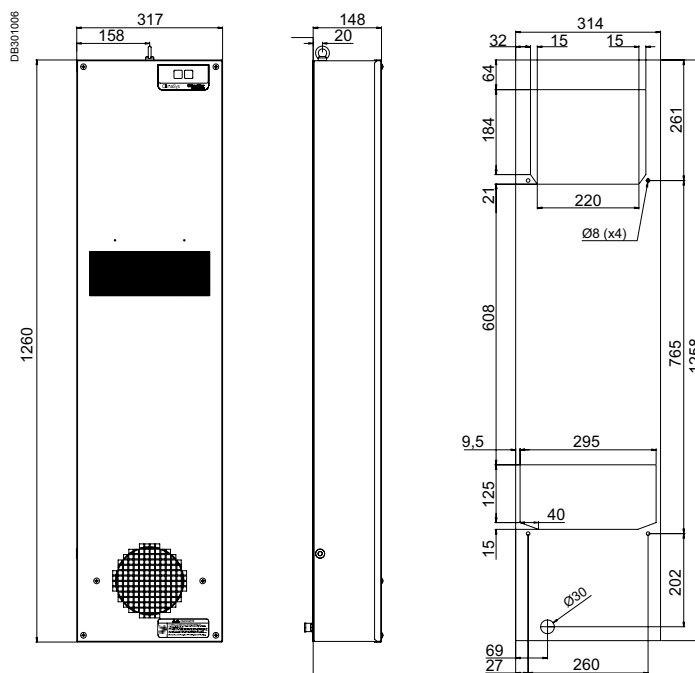

Units of measurement are mm.

Thermal management system Introduction

New

> Choose **air-water exchangers** for especially difficult environments where there is no external air circuit available but a stable cold-water circuit can be supplied.



Air-water exchangers: for highly polluted environments

PB502606-30



Many mounting options give you the right fit

Air-water exchangers offer roof and side mounting options.



Extended ratings to meet any challenge

Provide options for up to 15 kW of cooling power, among the world's highest power ratings for air-water exchangers.

PB502655-32



New material options adapt to any application

Air-water exchangers can be provided in the same material as electrical enclosures for (for example stainless steel) a homogeneous appearance and thermal performance.

DB123816-26



Certifications and declarations

- UL
- CE
- EAC

PB502607-13



Protection

All side-mounting models are IP55 type protected internally and externally according EN 60529. Top-mounting models are IP54.



Thermal management system

Characteristics

New

Air-water exchangers



Characteristics	Side-mounting models				
	Main components: thermostat adjustment system, Exchange cassette, fans for internal circuits of the enclosure, protection device against possible leaks. Eyebolts included in all models.				
Material	RAL 7035 grey painted zinc-coated steel or stainless steel				
Ingress protection rating	IP55				
Certifications	<ul style="list-style-type: none"> ■ CE declaration ■ UL (only references ending with UL) ■ EAC 				
Installation	Indoor				
Cooling characteristics					
Cooling power W10A35	1000 W	1750 W	2500 W	3500 W	4500 W
Hydraulic circuit maximum pressure	5 bar	5 bar	5 bar	5 bar	5 bar
Internal airflow	330 m ³ /h	570 m ³ /h	860 m ³ /h	1050 m ³ /h	1450 m ³ /h
Thermostat type	Mechanical	Mechanical	Mechanical	Mechanical	Mechanical
Temperature setting range	+20 ... +46°C	+20 ... +46°C	+20 ... +46°C	+20 ... +46°C	+20 ... +46°C
Temperature range external circuit (ambient)	+1 ... +70°C	+1 ... +70°C	+1 ... +70°C	+1 ... +70°C	+1 ... +70°C
Type of fluid	Filtered water or glycolised water	Filtered water or glycolised water	Filtered water or glycolised water	Filtered water or glycolised water	Filtered water or glycolised water
Water flow	150 l/h	150 l/h	500 l/h	500 l/h	500 l/h
Pressure drop	0.1 bar	0.1 bar	0.3 bar	0.2 bar	0.2 bar
Hydraulic connection	3/8" G	1/2" G	1/2" G	1/2" G	1/2" G
Electric characteristics					
Input voltage	1 x 230 V / 50-60 Hz*	1 x 230 V / 50-60 Hz*	1 x 230 V / 50-60 Hz*	1 x 230 V / 50-60 Hz*	1 x 230 V / 50-60 Hz*
Rated Intensity	0.17 A	0.36 A	0.33 A	0.55 A	0.71 A
Power consumption absorbed W10A35	29 W	75 W	80 W	130 W	160 W
Thermal protection recommended (fuse)	T2A	T2A	T2A	T2A	T2A
Physical characteristics					
External dimensions (H x W x D)	450 x 310 x 115 mm	901 x 398 x 137 mm	901 x 398 x 137 mm	1148 x 398 x 163 mm	1148 x 398 x 163 mm
Protection degree IP internal / external	IP55 / IP55	IP55 / IP55	IP55 / IP55	IP55 / IP55	IP55 / IP55
Noise level	55 dB (A)	58 dB (A)	58 dB (A)	64 dB (A)	69 dB (A)
Weight of unit	12 kg	18 kg	19 kg	29 kg	30 kg
References					
Steel	NSYCEW1K	NSYCEW1K8	NSYCEW2K5	NSYCEW3K5	NSYCEW4K5
Stainless steel	NSYCEWX1K	NSYCEWX1K8	NSYCEWX2K5	NSYCEWX3K5	NSYCEWX4K5
Steel UL	NSYCEW1KUL	NSYCEW1K8UL	NSYCEW2K5UL	NSYCEW3K5UL	NSYCEW4K5UL
Stainless steel UL	NSYCEWX1KUL	NSYCEWX1K8UL	NSYCEWX2K5UL	NSYCEWX3K5UL	NSYCEWX4K5UL

* 60 Hz only for UL versions.

Thermal management system

Characteristics



Top-mounting model

IP54

	6000 W	6000 W	10000 W	10000 W	15000 W	15000 W	2500 W
	5 bar	8 bar	8 bar	8 bar	8 bar	8 bar	5 bar
	1450 m³/h	1450 m³/h	2420 m³/h	2420 m³/h	2900 m³/h	2900 m³/h	750 m³/h
	Mechanical	Mechanical	Mechanical	Mechanical	Mechanical	Mechanical	Mechanical
	+20 ... +46°C	+20 ... +46°C	+20 ... +46°C	+20 ... +46°C	+20 ... +46°C	+20 ... +46°C	+20 ... +46°C
	+1 ... +70°C	+1 ... +70°C	+1 ... +70°C	+1 ... +70°C	+1 ... +70°C	+1 ... +70°C	+1 ... +70°C
	Filtered water or glycolised water	Filtered water or glycolised water	Filtered water or glycolised water	Filtered water or glycolised water	Filtered water or glycolised water	Filtered water or glycolised water	Filtered water or glycolised water
	800 l/h	800 l/h	2000 l/h	2000 l/h	2000 l/h	2000 l/h	500 l/h
	0.5 bar	0.5 bar	3.5 bar	3.5 bar	4.8 bar	4.8 bar	0.3 bar
	1/2" G	1/2" G	3/4" G	3/4" G	3/4" G	3/4" G	1/2" G
	1 x 230 V / 50-60 Hz*	2 x 400-440V / 50-60 Hz	1 x 230 V / 50-60 Hz	2 x 400-440V / 50-60 Hz	1 x 230 V / 50-60 Hz	2 x 400-440V / 50-60 Hz	1 x 230 V / 50-60 Hz
	0.71 A	0.4 A	1.2 A	0.75 A	1.4 A	0.9 A	0.30 A
	160 W	170 W	260 W	280 W	320 W	420 W	65 W
	T2A	T1A	T2A	T2A	T4A	T2A	T2A
	1500 x 450 x 163 mm	1500 x 450 x 163 mm	1932 x 797 x 206 mm	1932 x 797 x 206 mm	1932 x 797 x 206 mm	1932 x 797 x 206 mm	270 x 400 x 542 mm
	IP55 / IP55	IP55 / IP55	IP55 / IP55	IP55 / IP55	IP55 / IP55	IP55 / IP55	IP54 / IP55
	69 dB (A)	69 dB (A)	70 dB (A)	70 dB (A)	72 dB (A)	70 dB (A)	58 dB (A)
	40 kg	42 kg	90 kg	90 kg	92 kg	92 kg	19 kg
	NSYCEW6K	NSYCEW6K2P4	NSYCEW10K**	NSYCEW10K2P4**	NSYCEW15K**	NSYCEW15K2P4**	NSYCEW2K5R
	NSYCEWX6K	NSYCEWX6K2P4	NSYCEWX10K**	NSYCEWX10K2P4**	NSYCEWX15K**	NSYCEWX15K2P4**	-
	NSYCEW6KUL	-	-	-	-	-	-
	NSYCEWX6KUL	-	-	-	-	-	-

** Available from 2016.

New

Air-water exchangers

Side-mounting models

NSYCEW••1K••

Performance curves

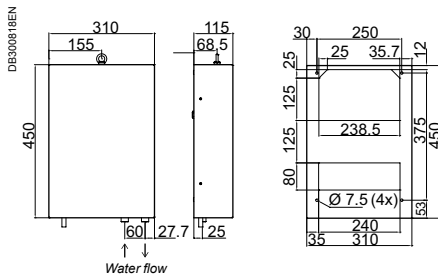
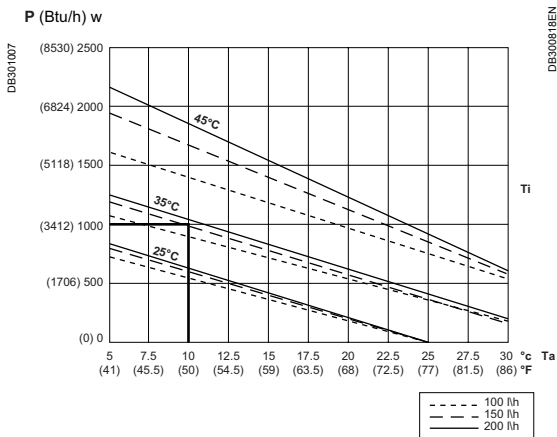

Performance curves

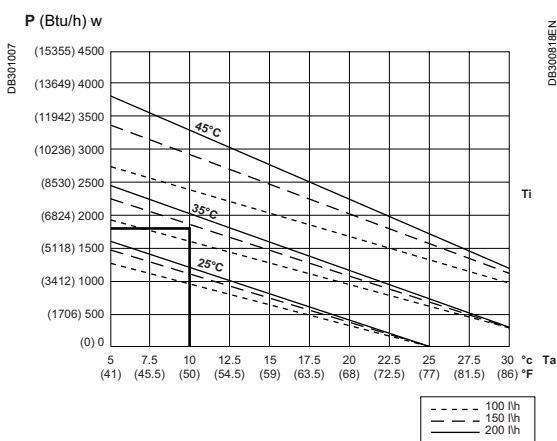

NSYCEW••1K8•• – NSYCEW••2K5••

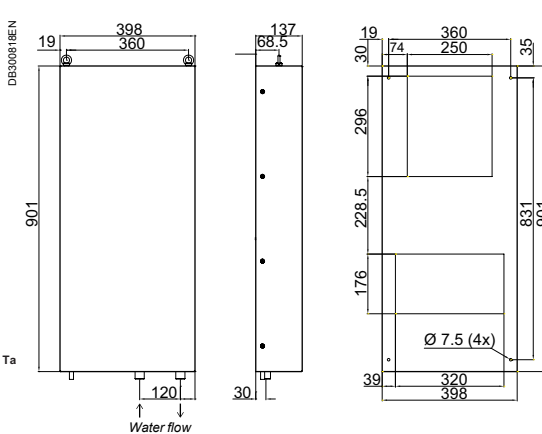

Performance curves

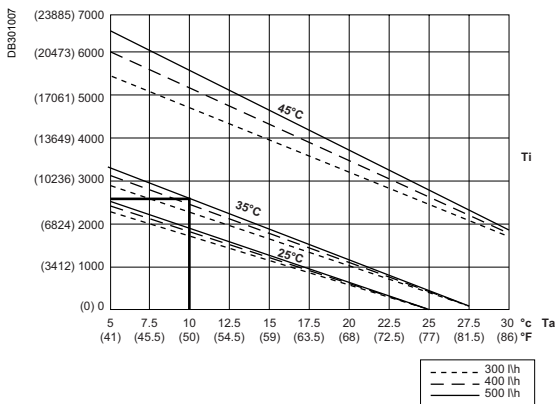

P = Cooling power
 Ta = Inlet water temperature
 Ti = Desired internal temperature of the enclosure

Units of measurement are mm.

New

NSYCEW•3K5•• – NSYCEW•4K5••

Performance curves

P (Btu/h) w

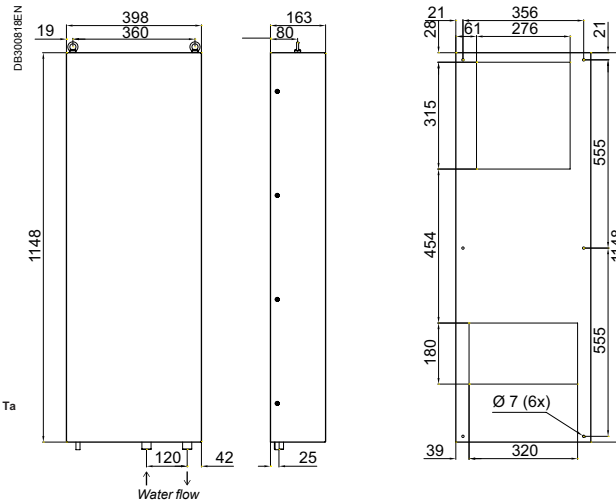
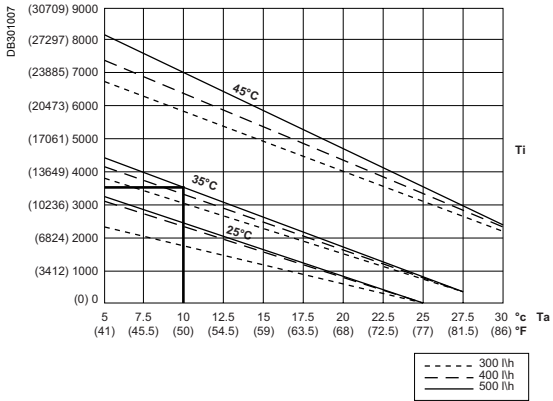

P (Btu/h) w

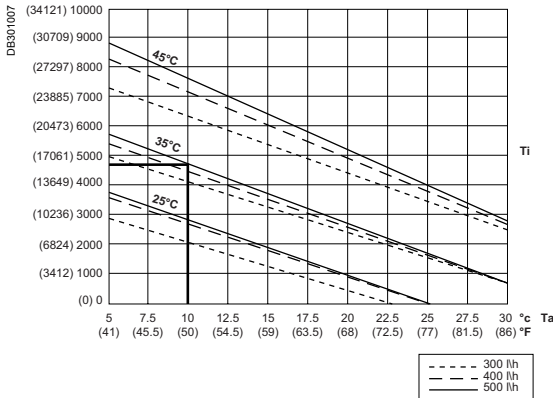

NSYCEW•6K••

Performance curves

P (Btu/h) w

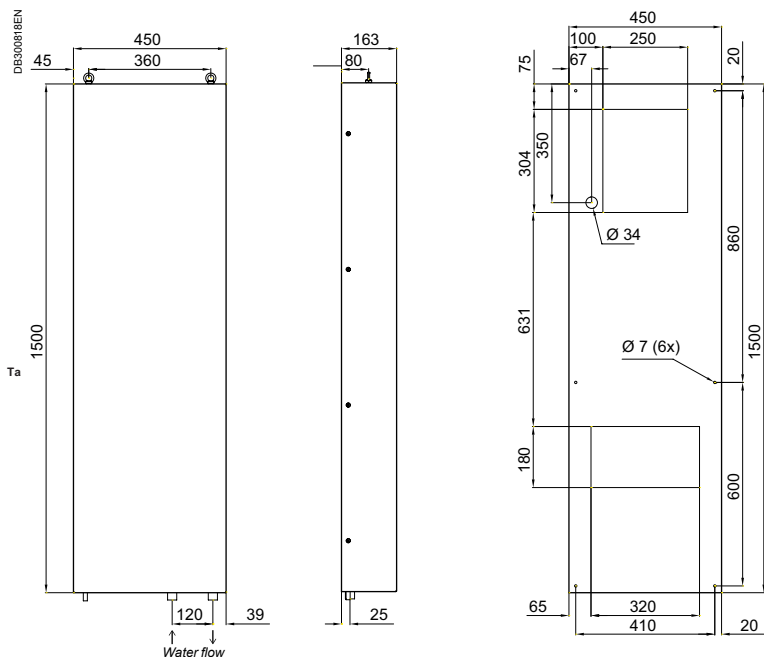
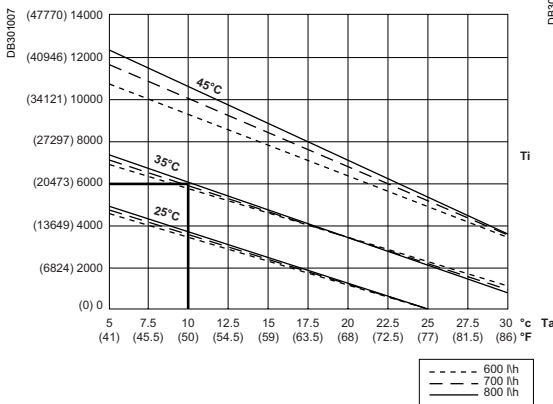

P = Cooling power
 Ta = Inlet water temperature
 Ti = Desired internal temperature of the enclosure

Units of measurement are mm.

Thermal management system Dimensions

New

NSYCEW••10K•• – NSYCEW••15K••

Performance curves

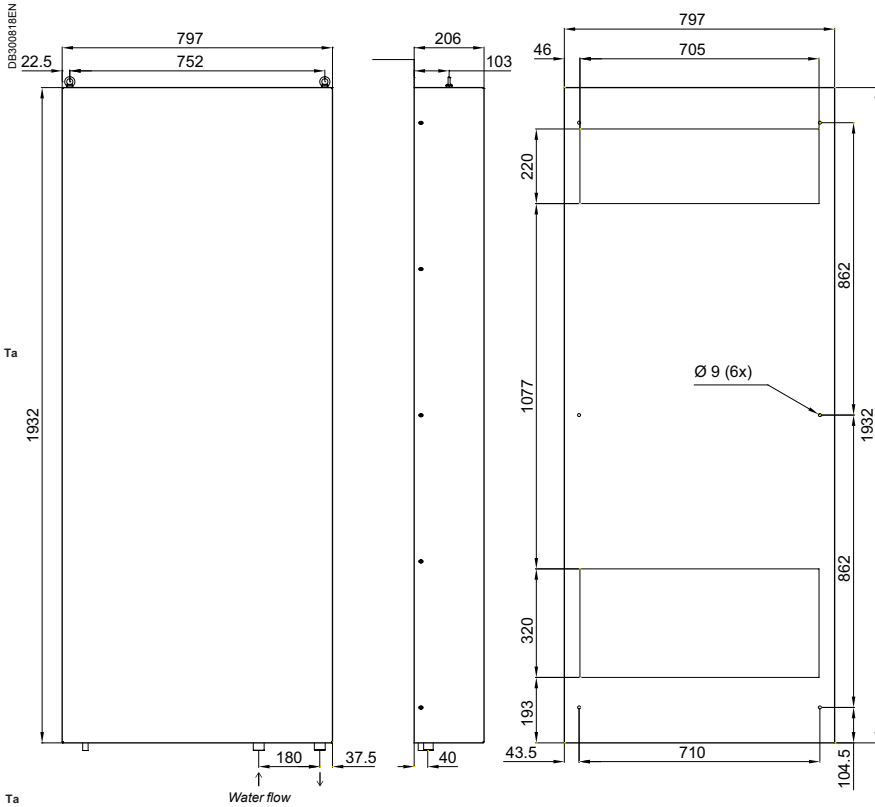
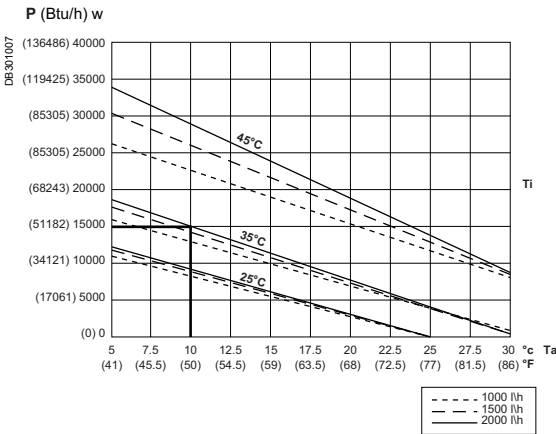
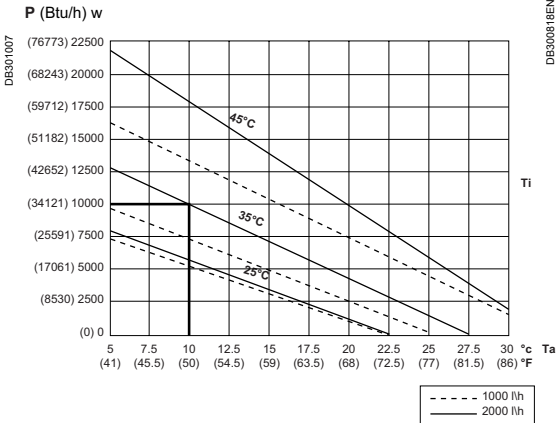

Top-mounting models

NSYCEW2K5R

Performance curves

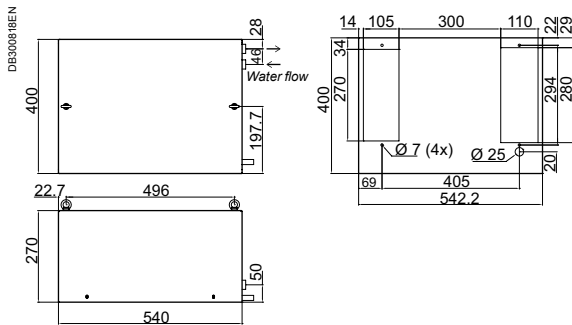
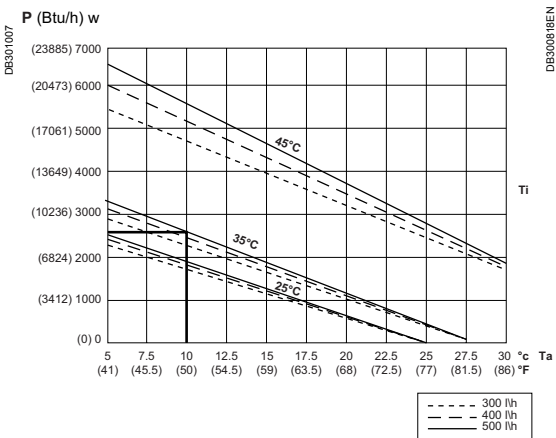

P = Cooling power
 Ta = Inlet water temperature
 Ti = Desired internal temperature of the enclosure

Units of measurement are mm.

Thermal management system Accessories

New

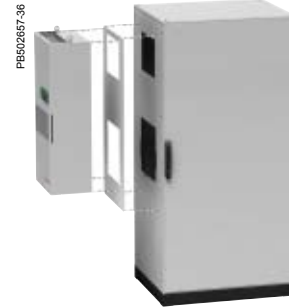

Characteristics	Air-air and air-water exchangers				Retrofit panel	
	CE		UL / CE			
	Steel	Stainless steel	Steel	Stainless steel		
Material					Panel that enable to mount a new ClimaSys CE units by replacement of old Schneider Electric cooling systems.	
Colour					Metal painted	
Supply					RAL 7035	
References					1 unit	
					Retrofit panel	Old Schneider Electric cooling system
Air - air exchangers						
Side-mounting models	NSYCEA36	-	-	-	NSYCEARTFIT36	NSYCEA35W230VL NSYCEA35W230VLE
	NSYCEA50	-	-	-	-	-
	NSYCEA80	-	-	-	NSYCEARTFIT80	NSYCEA70W230VL
Air-water exchangers						
Side-mounting models	NSYCEW1K	NSYCEWX1K	NSYCEW1KUL	NSYCEWX1KUL	-	-
	NSYCEW1K8	NSYCEWX1K8	NSYCEW1K8UL	NSYCEWX1K8UL	-	-
	NSYCEW2K5	NSYCEWX2K5	NSYCEW2K5UL	NSYCEWX2K5UL	NSYCEWRTFIT2K5	NSYCEW2100W230VL
	NSYCEW3K5	NSYCEWX3K5	NSYCEW3K5UL	NSYCEWX3K5UL	NSYCEWRTFIT3K5	NSYCEW3150W230VL
	NSYCEW4K5	NSYCEWX4K5	NSYCEW4K5UL	NSYCEWX4K5UL	-	-
	NSYCEW6K	NSYCEWX6K	NSYCEW6KUL	NSYCEWX6KUL	-	-
	NSYCEW6K2P4	NSYCEWX6K2P4	-	-	-	-
	NSYCEW10K	NSYCEWX10K	-	-	-	-
	NSYCEW10K2P4	NSYCEWX10K2P4	-	-	-	-
	NSYCEW15K	NSYCEWX15K	-	-	-	-
	NSYCEW15K2P4	NSYCEWX15K2P4	-	-	-	-
Top-mounting model	NSYCEW2K5R	-	-	-	-	-

C



Schneider
Model: 1200V
Type: 1200V
Rating: 1200V
Current: 100A
Voltage: 1200V
Frequency: 50/60Hz
Power: 120kVA
Dimensions: 400x600x200mm
Weight: 15kg
CE

1200V
100A

Thermal management system

Introduction

New

> Choose **cooling units** for harsh environments, where **ambient temperatures can reach up to 55°C**. The unit's integrated alarm system will signal you in the event of any operational anomaly.



Cooling units: For a high ambient temperature



Several mounting solutions

Three models: roof model, floor model, side model. There is also a SLIM model which permits a space saving and perfect integration on the doors of control panels.



Large range of power levels

Provide options for up to 15 kW of cooling power.

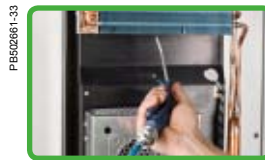

Enhanced protection

An internal grid of a new design protects the components and personnel during operation of the equipment while at the same time **facilitating cleaning and maintenance**.



Speed of access to information

The new screen offers fast access to the configuration parameters and information from the sensors located in the enclosure (does not apply to heavy-duty outdoor enclosures).



New materials

Stainless steel and painted galvanized steel for the outside dedicated to clean, hygienic environments such as food and beverage production plants.



Precision of temperature control

All ClimaSys cooling units are provided with a precise **electronic control system by thermostat** which gives them high cooling precision (+/- 1.5°C).



Broad temperature range for outdoor enclosures

The outdoor version can withstand extreme environments, with an **operating temperature range** of -20°C to +55°C.



Certifications and declarations

- UL
- CE
- EAC



Simplicity

No tools needed to replace the filter. It just takes a few seconds.

D

Thermal management system

Characteristics

New

Cooling units



Characteristics		Side-mounting models			
		<ul style="list-style-type: none"> ■ Respect for the environment by using environmentally friendly gas R134a (HFC). ■ Electronic thermostats in all models. ■ Alarm signal for door contact included in all models. ■ Eyebolts included. ■ The external filter, not included as standard, is strongly recommended for harsh environments. ■ HMI screen. 			
Material		RAL 7035 grey painted zinc-coated steel or stainless steel			
Certifications		<ul style="list-style-type: none"> ■ CE declaration ■ UL (only references ending with UL) ■ EAC 			
Installation		Indoor			
Cooling characteristics					
Cooling power L35-L35		300 W (1024 Btu/h)	380 W (1297 Btu/h)	640 W (2184 Btu/h)	820 W (2798 Btu/h)
Cooling power L35-L50		150 W (512 Btu/h)	240 W (819 Btu/h)	470 W (1604 Btu/h)	680 W (2320 Btu/h)
Air flow of the internal circuit (enclosure)		280 m ³ /h	280 m ³ /h	330 m ³ /h	330 m ³ /h
Air flow of the external circuit (ambient)		280 m ³ /h	280 m ³ /h	570 m ³ /h	570 m ³ /h
Thermostat type		Electronic	Electronic	Electronic	Electronic
Temperature range internal circuit (enclosure)		+20 ... +46°C	+20 ... +46°C	+20 ... +46°C	+20 ... +46°C
Maximum outside temperature		+55°C	+55°C (+50°C)*	+55°C (+50°C)*	+55°C (+50°C)*
Temperature range external circuit (ambient)		+5 ... +55°C*	+5 ... +55°C* (+5 ... +50°C)*	+5 ... +55°C* (+5 ... +50°C)*	+5 ... +55°C* (+5 ... +50°C)*
Type of cooling gas		R134a	R134a	R134a	R134a
Cooling gas weight		0.13 kg	0.16 kg	0.23 kg	0.23 kg
Maximum pressure cooling circuit		25 bar	26 bar (28 bar)**	25 bar (28 bar)**	25 bar (28 bar)**
External filter		Optional, see page 55	Optional, see page 55	Optional, see page 55	Optional, see page 55
Electric characteristics					
Input voltage		1 x 230 V / 50-60 Hz	1 x 230 V / 50-60 Hz**	1 x 230 V / 50-60 Hz**	1 x 230 V / 50-60 Hz**
Starting / Rated Intensity		4.2 A / 1.5 A	6.0 A / 1.6 A	8.1 A / 2.1 A	10.8 A / 2.6 A
Power consumption absorbed L35-L35		270 W	280 W	400 W	440 W
Power consumption absorbed L35-L50		310 W	330 W	470 W	490 W
Energy efficiency ratio (EER) L35-L35		1.1	1.4	1.6	1.9
Thermal protection recommended (fuse)		T4 A	T4 A	T6 A	T6 A
Physical characteristics					
External dimensions (H x W x D)		340 x 525 x 135 mm	460 x 285 x 180 mm	606 x 316 x 212 mm	783 x 348 x 215 mm
Protection degree IP internal /external		IP55 / IP34	IP55 / IP34	IP55 / IP34	IP55 / IP34
Noise level		61 dB	60 dB	65 dB	65 dB
Weight of unit		17 kg	17 kg	21 kg	27 kg
References					
Steel		NSYCU300H	NSYCU400	NSYCU600	NSYCU800
Stainless steel		-	NSYCUX400	NSYCUX600	NSYCUX800
Steel UL		-	NSYCU400UL	NSYCU600UL	NSYCU800UL
Stainless steel UL		-	-	NSYCUX600UL	NSYCUX800UL

* 50°C at 60 Hz.

** Certification UL only 60 Hz.

Thermal management system

Characteristics



	1000 W (3412 Btu/h)	1000 W (3412 Btu/h)	1250 W (4265 Btu/h)	1250 W (4265 Btu/h)	1600 W (5459 Btu/h)	1600 W (5459 Btu/h)	2000 W (6824 Btu/h)
	790 W (2696 Btu/h)	790 W (2696 Btu/h)	910 W (3105 Btu/h)	910 W (3105 Btu/h)	1230 W (4197 Btu/h)	1230 W (4197 Btu/h)	1510 W (5152 Btu/h)
	330 m³/h	330 m³/h	570 m³/h	570 m³/h	570 m³/h	570 m³/h	860 m³/h
	570 m³/h	570 m³/h	860 m³/h	860 m³/h	1050 m³/h	1050 m³/h	1050 m³/h
	Electronic	Electronic	Electronic	Electronic	Electronic	Electronic	Electronic
	+20 ... +46°C	+20 ... +46°C	+20 ... +46°C	+20 ... +46°C	+20 ... +46°C	+20 ... +46°C	+20 ... +46°C
	+55°C (+50°C)*	+55°C (+50°C)*	+55°C (+50°C)*	+55°C	+55°C (+50°C)*	+50°C*	+55°C (+50°C)*
	+5 ... +55°C* (+5 ... +50°C)*	+5 ... +50°C (+5 ... +50°C)*	+5 ... +55°C* (+5 ... +50°C)*	+5 ... +50°C	+5 ... +55°C* (+5 ... +50°C)*	+5 ... +50°C	+5 ... +55°C* (+5 ... +50°C)*
	R134a	R134a	R134a	R134a	R134a	R134a	R134a
	0.23 kg	0.23 kg	0.38 kg	0.38 kg	0.45 kg	0.45 kg	0.54 kg
	25 bar (28 bar)**	25 bar (28 bar)**	25 bar (28 bar)**	25 bar	25 bar (28 bar)**	25 bar (28 bar)**	25 bar (28 bar)**
	Optional, see page 55	Optional, see page 55	Optional, see page 55	Optional, see page 55	Optional, see page 55	Optional, see page 55	Optional, see page 55
	1 x 230 V / 50-60 Hz**	2 x 400-440 V / 50-60 Hz 2 x 400-460 V / 50-60 Hz**	1 x 230 V / 50-60 Hz**	2 x 400-440 V / 50-60 Hz	1 x 230 V / 50-60 Hz**	2 x 400-440 V / 50-60 Hz 2 x 460 V / 60 Hz**	1 x 230 V / 50-60 Hz**
	10.5 A / 3 A	8 A / 2 A	11 A / 3.8 A	8.5 A / 2.8 A	18 A / 5.4 A	11 A / 2.9 A	24 A / 6.5 A
	570 W	590 W	650 W	650 W	850 W	840 W	1080 W
	650 W	670 W	760 W	770 W	970 W	960 W	1290 W
	1.8	1.7	1.9	1.9	1.9	1.9	1.9
	T6 A	T4 A	T6 A	T4 A	T10 A	T6 A	T10 A
	783 x 348 x 215 mm	783 x 348 x 215 (+58) mm	999 x 405 x 237 mm	999 x 405 x 237 mm	999 x 405 x 237 mm	999 x 405 x 237 mm	999 x 405 x 237 mm
	IP55 / IP34	IP55 / IP34	IP55 / IP34	IP55 / IP34	IP55 / IP34	IP55 / IP34	IP55 / IP34
	65 dB	65 dB	65 dB	65 dB	65 dB	65 dB	65 dB
	28 kg	29 kg	38 kg	40 kg	40 kg	42 kg	52 kg
	NSYCU1K	NSYCU1K2P4	NSYCU1K2	NSYCU1K22P4	NSYCU1K6	NSYCU1K62P4	NSYCU2K
	NSYCUX1K	NSYCUX1K2P4	NSYCUX1K2	NSYCUX1K22P4	NSYCUX1K6	NSYCUX1K62P4	NSYCUX2K
	NSYCU1KUL	NSYCU1K2P4UL	NSYCU1K2UL	-	NSYCU1K6UL	NSYCU1K62P4UL	NSYCU2KUL
	NSYCUX1KUL	NSYCUX1K2P4UL	NSYCUX1K2UL	-	NSYCUX1K6UL	NSYCUX1K62P4UL	NSYCUX2KUL

D

Thermal management system

Characteristics

New

Cooling units



Characteristics	Side-mounting models			Floor-standing models
	<ul style="list-style-type: none"> ■ Alarm signal for door contact included in all models. ■ Eyebolts included. ■ The external filter, not included as standard, is strongly recommended for harsh environments. 			
Material	RAL 7035 grey painted zinc-coated steel or stainless steel			
Certifications	<ul style="list-style-type: none"> ■ CE declaration ■ UL (only references ending with UL) ■ EAC 			
Installation	Indoor			Indoor
Cooling characteristics				
Cooling power L35-L35	2000 W (6824 Btu/h)	2900 W (9895 Btu/h)	3850 W (13137 Btu/h)	5800 W (19790 Btu/h)
Cooling power L35-L50	1510 W (5152 Btu/h)	2250 W (7677 Btu/h)	2870 W (9793 Btu/h)	4350 W (14843 Btu/h)
Air flow of the internal circuit (enclosure)	860 m³/h	1450 m³/h	1450 m³/h	1450 m³/h
Air flow of the external circuit (ambient)	1050 m³/h	1450 m³/h	1450 m³/h	2900 m³/h
Thermostat type	Electronic	Electronic	Electronic	Electronic
Temperature range internal circuit (enclosure)	+20 ... +46°C (+45°C)*	+20 ... +46°C (+45°C)*	+20 ... +46°C (+45°C)*	+20 ... +46°C
Maximum outside temperature	+50°C (+45°C)	+50°C (+45°C)	+50°C (+45°C)	+50°C
Temperature range external circuit (ambient)	+5 ... +50°C (+5 ... +45°C)*	+5 ... +50°C (+5 ... +45°C)*	+5 ... +50°C (+5 ... +45°C)*	+10 ... +50°C
Type of cooling gas	R134a	R134a	R134a	R407c
Cooling gas weight	0.59 kg	0.84 kg	1.14 kg	1.8 kg
Maximum pressure cooling circuit	25 bar (28 bar)*	25 bar (28 bar)*	25 bar (28 bar)*	27 bar
External filter	Optional, see page 55	Optional, see page 55	Optional, see page 55	Polyurethane filter standard
Electric characteristics				
Input voltage	3 x 400 V / 50-60 Hz 3 x 460 V / 60 Hz*	3 x 400 V / 50-60 Hz 3 x 460 V / 60 Hz*	3 x 400 V / 50-60 Hz 3 x 460 V / 60 Hz*	3 x 400 V / 50 Hz
Starting / Rated Intensity	10 A / 2.5 A	14 A / 2.6 A	18 A / 3.6 A	21.7 A / 5.9 A
Power consumption absorbed L35-L35	970 W	1220 W	1780 W	2340 W
Power consumption absorbed L35-L50	1150 W	1440 W	2050 W	3880 W
Energy efficiency ratio (EER) L35-L35	2.1	2.4	2.2	2.5
Thermal protection recommended (fuse)	T6 A	T6 A	T8 A	T8 A
Physical characteristics				
External dimensions (H x W x D)	999 x 405 x 237 mm	1270 x 500 x 336 mm	1270 x 500 x 336 mm	2000 x 600 x 380 mm
Protection degree IP internal /external	IP55 / IP34	IP55 / IP34	IP55 / IP34	IP54 / IP34
Noise level	65 dB	70 dB	70 dB	72 dB
Weight of unit	54 kg	84 kg	85 kg	150 kg
References				
Steel	NSYCU2K3P4	NSYCU3K3P4	NSYCU4K3P4	NSYCU6K3P4**
Stainless steel	NSYCU2K3P4	NSYCU3K3P4	NSYCU4K3P4	-
Steel UL	NSYCU2K3P4UL	NSYCU3K3P4UL	NSYCU4K3P4UL	-
Stainless steel UL	NSYCU2K3P4UL	NSYCU3K3P4UL	NSYCU4K3P4UL	-

* Certification UL only 60 Hz.

** Available from 2016.

Thermal management system

Characteristics



D

Indoor						
6050 W (20643 Btu/h)	7600 W (25932 Btu/h)	7950 W (27126 Btu/h)	9400 W (32074 Btu/h)	9850 W (33610 Btu/h)	14800 W (50500 Btu/h)	15150 W (51694 Btu/h)
4350 W (14843 Btu/h)	5700 W (19449 Btu/h)	5930 W (20234 Btu/h)	7000 W (23885 Btu/h)	7350 W (25079 Btu/h)	11300 W (38557 Btu/h)	11600 W (39581 Btu/h)
1450 m³/h	2900 m³/h	2900 m³/h	2900 m³/h	2900 m³/h	4300 m³/h	4300 m³/h
2900 m³/h	2900 m³/h	2900 m³/h	2900 m³/h	2900 m³/h	5800 m³/h	5800 m³/h
Electronic	Electronic	Electronic	Electronic	Electronic	Electronic	Electronic
+20 ... +46°C	+20 ... +46°C	+20 ... +46°C	+20 ... +46°C	+20 ... +46°C	+20 ... +46°C	+20 ... +46°C
+50°C	+50°C	+50°C	+50°C	+50°C	+55°C	+55°C
+10 ... +50°C	+10 ... +50°C	+10 ... +50°C	+10 ... +45°C	+10 ... +45°C	+10 ... +50°C	+10 ... +50°C
R407c	R134a	R134a	R134a	R134a	R410a	R410a
1.8 kg	2.8 kg	2.8 kg	2.3 kg	2.3 kg	3.5 kg	3.5 kg
27 bar	27 bar	27 bar	27 bar	27 bar	39 bar	39 bar
Polyurethane filter standard	Polyurethane filter standard	Polyurethane filter standard	Polyurethane filter standard	Polyurethane filter standard	Polyurethane filter standard	Polyurethane filter standard
3 x 460 V / 60 Hz	3 x 400 V / 50 Hz	3 x 460 V / 60 Hz	3 x 400 V / 50 Hz	3 x 460 V / 60 Hz	3 x 400 V / 50 Hz	3 x 460 V / 60 Hz
23.5 A / 6.8 A	43.8 A / 7.2 A	44.5 A / 7.9 A	30.7 A / 9.1 A	32.5 A / 10.3 A	49 A / 11 A	51 A / 11.8 A
2920 W	3530 W	4210 W	3850 W	4380 W	5750 W	6580 W
4520 W	4270 W	5340 W	5400 W	6340 W	6900 W	7760 W
2.1	2.2	1.9	2.4	2.2	2.6	2.3
T8 A	T10 A	T10 A	T18 A	T18 A	T20 A	T20 A
2000 x 600 x 380 mm	2000 x 800 x 380 mm	2000 x 800 x 380 mm	2000 x 800 x 380 mm	2000 x 800 x 380 mm	2000 x 800 x 550 mm	2000 x 800 x 550 mm
IP54 / IP34	IP54 / IP34	IP54 / IP34	IP54 / IP34	IP54 / IP34	IP54 / IP34	IP54 / IP34
72 dB	72 dB	72 dB	77 dB	77 dB	67 dB	67 dB
150 kg	160 kg	160 kg	180 kg	180 kg	240 kg	240 kg
NSYCU6K3P460**	NSYCU8K3P4**	NSYCU8K3P460**	NSYCU10K3P4**	NSYCU10K3P460**	NSYCU15K3P4**	NSYCU15K3P460**
-	-	-	-	-	-	-
-	-	-	-	-	-	-
-	-	-	-	-	-	-

Thermal management system

Characteristics

New

Cooling units



Characteristics	Top-mounting models		
	<ul style="list-style-type: none"> Respect for the environment by using environmentally friendly gas R134a (HFC). Automatic evaporation system. Alarm signal for door contact included in all models. Eyebolts included. The external filter, not included as standard, is strongly recommended for harsh environments. 		
Material	RAL 7035 grey painted zinc-coated steel or stainless steel.		
Certifications	<ul style="list-style-type: none"> CE declaration UL (only references ending with UL) EAC 		
Installation	Indoor		
Cooling characteristics			
Cooling power L35-L35	410 W (1399 Btu/h)	820 W (2798 Btu/h)	1150 W (3924 Btu/h)
Cooling power L35-L50	240 W (819 Btu/h)	680 W (2320 Btu/h)	900 W (3071 Btu/h)
Air flow of the internal circuit (enclosure)	235 m ³ /h	570 m ³ /h	570 m ³ /h
Air flow of the external circuit (ambient)	330 m ³ /h	860 m ³ /h	1010 m ³ /h
Thermostat type	Electronic	Electronic	Electronic
Temperature range internal circuit (enclosure)	+20 ... +46°C	+20 ... +46°C	+20 ... +46°C
Maximum outside temperature	+55°C (+50°C)*	+55°C (+50°C)*	+55°C (+50°C)*
Temperature range external circuit (ambient)	+5 ... +55°C* (+5 ... +50°C)*	+5 ... +55°C* (+5 ... +50°C)*	+5 ... +55°C* (+5 ... +50°C)*
Type of cooling gas	R134a	R134a	R134a
Cooling gas weight	0.17 kg	0.31 kg	0.63 kg
Maximum pressure cooling circuit	28 bar	25 bar (28 bar)**	25 bar (28 bar)**
External filter	Optional, see page 55	Optional, see page 55	Optional, see page 55
Electric characteristics			
Input voltage	1 x 230 V / 50-60 Hz**	1 x 230 V / 50-60 Hz**	1 x 230 V / 50-60 Hz**
Starting / Rated Intensity	4 A / 1.5 A	12 A / 2.9 A	11 A / 3.2 A
Power consumption absorbed L35-L35	230 W	510 W	550 W
Power consumption absorbed L35-L50	290 W	560 W	660 W
Energy efficiency ratio (EER) L35-L35	1.8	1.6	2.1
Thermal protection recommended (fuse)	T4 A	T6 A	T6 A
Physical characteristics			
External dimensions (H x W x D)	264 x 486 x 259 mm	340 x 600 x 340 mm	415 x 567 x 401 mm
Protection degree IP internal /external	IP54 / IP34	IP54 / IP34	IP54 / IP34
Noise level	65 dB	65 dB	65 dB
Weight of unit	18 kg	23 kg	40 kg
References			
Steel	NSYCU400R	NSYCU800R	NSYCU1K2R
Stainless steel	NSYCUX400R	NSYCUX800R	NSYCUX1K2R
Steel UL	NSYCU400RUL	NSYCU800RUL	NSYCU1K2RUL

* 50°C at 60 Hz.

** Certification UL only 60 Hz.

Device for dissipating condensation water (external installation)

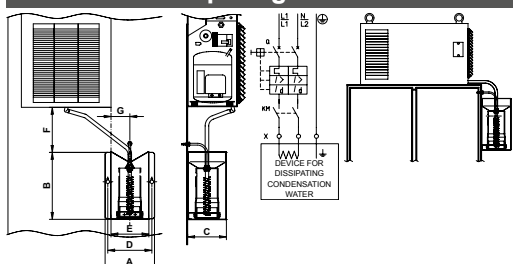

- Device allowing the evacuation of condensation water from the internal battery (evaporator).
- Supplied with stainless-steel support.
- Power supply:

Operating voltage $\pm 10\%$

Voltage	Starting current	Thermal protection recommended	Evaporation capacity	Resistance type
230 V~	2.9 A	T 3 A	200 cl/h	PTC
115 V~	5.8 A	T 6 A		

Heat sink
NSYCUAD

Thermal management system

Characteristics



1550 W (5289 Btu/h)	2050 W (6995 Btu/h)	2050 W (6995 Btu/h)	2900 W (9895 Btu/h)	3850 W (13137 Btu/h)
1200 W (4095 Btu/h)	1560 W (5323 Btu/h)	1560 W (5323 Btu/h)	2250 W (7677 Btu/h)	2870 W (9793 Btu/h)
860 m³/h	1050 m³/h	1050 m³/h	860 m³/h	1450 m³/h
1820 m³/h	1820 m³/h	1820 m³/h	3410 m³/h	3410 m³/h
Electronic	Electronic	Electronic	Electronic	Electronic
+20 ... +46°C	+20 ... +46°C	+20 ... +46°C	+20 ... +46°C	+20 ... +46°C
+55°C	+55°C (+50°C)**	+50°C (+45°C)**	+50°C (+45°C)**	+50°C (+45°C)**
+5 ... +55°C* (+5 ... +50°C)*	+5 ... +55°C*	+5 ... +50°C (+5 ... +45°C)**	+5 ... +50°C (+5 ... +45°C)**	+5 ... +50°C (+5 ... +45°C)**
R134a	R134a	R134a	R134a	R134a
0.54 kg	0.55 kg	0.55 kg	1.20 kg	1.60 kg
25 bar (28 bar)**	25 bar	25 bar (28 bar)**	25 bar (28 bar)**	25 bar (28 bar)**
Optional, see page 55	Optional, see page 55	Optional, see page 55	Optional, see page 55	Optional, see page 55
1 x 230 V / 50-60 Hz**	1 x 230 V / 50-60 Hz	3 x 400 V / 50-60 Hz 3 x 460 V / 60 Hz*	3 x 400 V / 50-60 Hz 3 x 460 V / 60 Hz*	3 x 400 V / 50-60 Hz 3 x 460 V / 60 Hz*
18 A / 4.5 A	24 A / 6 A	10 A / 1.9 A	15.7 A / 2.5 A	17 A / 3.6 A
810 W	1150 W	990 W	1210 W	1790 W
930 W	1250 W	1190 W	1450 W	2010 W
1.9	1.8	2.1	2.4	2.2
T10 A	T10 A	T6 A	T6 A	T6 A
415 x 567 x 401 mm	415 x 567 x 401 mm	415 x 567 x 401 mm	496 x 797 x 492 mm	496 x 797 x 492 mm
IP54 / IP34	IP54 / IP34	IP54 / IP34	IP54 / IP34	IP54 / IP34
65 dB	65 dB	65 dB	75 dB	75 dB
44 kg	50 kg	52 kg	83 kg	86 kg
NSYCU1K5R	NSYCU2KR	NSYCU2K3P4R	NSYCU3K3P4R	NSYCU4K3P4R
NSYCUX1K5R	NSYCUX2KR	NSYCUX2K3P4R	NSYCUX3K3P4R	NSYCUX4K3P4R
NSYCU1K5RUL	-	NSYCU2K3P4RUL	NSYCU3K3P4RUL	NSYCU4K3P4RUL

D

Thermal management system

Characteristics

New

Outdoor Heavy Duty cooling units



Characteristics	Side-mounting models		
	<ul style="list-style-type: none"> ■ Respect for the environment by using environmentally friendly gas R134a (HFC). ■ Mechanical thermostats in all models. ■ Eyebolts included. ■ The external filter, not included as standard. The metallic filter is strongly recommended. ■ Metallic canopy as standard. ■ Anti-corrosive protection (class C3H). ■ Inside components, including the condenser, coated with anti-corrosive protection. 		
Material	RAL 7035 grey painted zinc-coated steel		
Certifications	<ul style="list-style-type: none"> ■ CE declaration ■ EAC 		
Installation	Indoor or outdoor		
Cooling characteristics			
Cooling power L35-L35	380 W (1297 Btu/h)	640 W (2184 Btu/h)	820 W (2798 Btu/h)
Cooling power L35-L50	240 W (819 Btu/h)	470 W (1604 Btu/h)	680 W (2320 Btu/h)
Air flow of the internal circuit (enclosure)	280 m³/h	330 m³/h	330 m³/h
Air flow of the external circuit (ambient)	280 m³/h	570 m³/h	570 m³/h
Thermostat type	Mechanic	Mechanic	Mechanic
Temperature range internal circuit (enclosure)	+20 ... +50°C	+20 ... +50°C	+20 ... +50°C
Maximum outside temperature	+55°C	+55°C	+55°C
Temperature range external circuit (ambient)	-20 ... +55°C	-20 ... +55°C	-20 ... +55°C
Type of cooling gas	R134a	R134a	R134a
Cooling gas weight	0.16 kg	0.26 kg	0.28 kg
Maximum pressure cooling circuit	26 bar	25 bar	25 bar
External filter	Optional, see metallic filter on page 55	Optional, see metallic filter on page 55	Optional, see metallic filter on page 55
Electric characteristics			
Input voltage	1 x 230 V / 50-60 Hz	1 x 230 V / 50-60 Hz	1 x 230 V / 50-60 Hz
Starting / Rated Intensity	6.0 A / 1.6 A	8.1 A / 2.1 A	10.8 A / 2.6 A
Power consumption absorbed L35-L35	280 W	400 W	440 W
Power consumption absorbed L35-L50	330 W	470 W	490 W
Energy efficiency ratio (EER) L35-L35	1.4	1.6	1.9
Thermal protection recommended (fuse)	T4 A	T6 A	T6 A
Physical characteristics			
External dimensions (H x W x D)	573 x 300 x 205 mm	718 x 331 x 235 mm	875 x 363 x 239 mm
Protection degree IP internal /external	IP55 / IP34	IP55 / IP34	IP55 / IP34
Noise level	60 dB	65 dB	65 dB
Weight of unit	17 kg	21 kg	27 kg
References	NSYCUHD400	NSYCUHD600	NSYCUHD800

Thermal management system

Characteristics

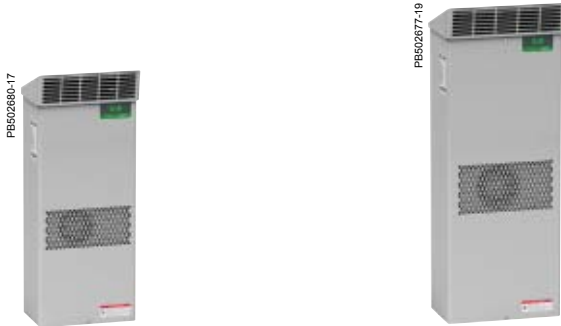

D

	1000 W (3412 Btu/h)	1000 W (3412 Btu/h)	1600 W (5459 Btu/h)	1600 W (5459 Btu/h)	2000 W (6824 Btu/h)	2900 W (9895 Btu/h)	3850 W (13137 Btu/h)
	790 W (2696 Btu/h)	790 W (2696 Btu/h)	1230 W (4197 Btu/h)	1230 W (4197 Btu/h)	1510 W (5152 Btu/h)	2250 W (7677 Btu/h)	2870 W (9793 Btu/h)
	330 m³/h	330 m³/h	570 m³/h	570 m³/h	860 m³/h	1450 m³/h	1450 m³/h
	570 m³/h	570 m³/h	1050 m³/h	1050 m³/h	1050 m³/h	1450 m³/h	1450 m³/h
	Mechanic	Mechanic	Mechanic	Mechanic	Mechanic	Mechanic	Mechanic
	+20 ... +50°C	+20 ... +50°C	+20 ... +50°C	+20 ... +50°C	+20 ... +50°C	+20 ... +50°C	+20 ... +50°C
	+55°C	+55°C	+55°C	+55°C	+55°C	+55°C	+55°C
	-20 ... +55°C	-20 ... +50°C	-20 ... +55°C	-20 ... +50°C	-20 ... +55°C	-20 ... +50°C	-20 ... +50°C
	R134a	R134a	R134a	R134a	R134a	R134a	R134a
	0.27 kg	0.27 kg	0.46 kg	0.46 kg	0.65 kg	0.84 kg	1.14 kg
	25 bar	25 bar	25 bar	25 bar	25 bar	25 bar	25 bar
	Optional, see metallic filter on page 55	Optional, see metallic filter on page 55	Optional, see metallic filter on page 55	Optional, see metallic filter on page 55	Optional, see metallic filter on page 55	Optional, see metallic filter on page 55	Optional, see metallic filter on page 55
	1 x 230 V / 50-60 Hz	2 x 400-440V / 50-60 Hz	1 x 230 V / 50-60 Hz	2 x 400-440V / 50-60 Hz	3 x 400 V / 50-60 Hz	3 x 400 V / 50-60 Hz	3 x 400 V / 50-60 Hz
	10.5 A / 3 A	8 A / 2 A	18 A / 5.3 A	11 A / 2.9 A	10 A / 2.5 A	14 A / 2.6 A	18 A / 3.6 A
	570 W	590 W	820 W	840 W	970 W	1220 W	1780 W
	650 W	670 W	940 W	960 W	1150 W	1440 W	2050 W
	1.8	1.7	2.0	1.9	2.1	2.4	2.2
	T6 A	T4 A	T10 A	T6 A	T6 A	T6 A	T8 A
	895 x 363 x 239 mm	895 x 363 x 239 (+58) mm	1009 x 415 x 261 mm	1009 x 415 x 261 mm	1009 x 415 x 261 mm	1416 x 512 x 365 mm	1416 x 512 x 365 mm
	IP55 / IP34	IP55 / IP34	IP55 / IP34	IP55 / IP34	IP55 / IP34	IP55 / IP34	IP55 / IP34
	65 dB	65 dB	65 dB	65 dB	65 dB	70 dB	70 dB
	28 kg	29 kg	40 kg	42 kg	54 kg	84 kg	85 kg
	NSYCUHD1K	NSYCUHD1K2P4	NSYCUHD1K6	NSYCUHD1K62P4	NSYCUHD2K3P4	NSYCUHD3K3P4	NSYCUHD4K3P4

Thermal management system

Characteristics

New

Slim cooling units



Characteristics	Side-mounting models			
	<ul style="list-style-type: none"> ■ Respect for the environment by using environmentally friendly gas R134a (HFC). ■ Electronical thermostat included. ■ 3 mounting positions (surface, half-flush and flush). ■ Alarm Signal for contact door. ■ Eyebolts included. 			
Material	RAL 7035 grey painted zinc-coated steel or stainless steel			
Certifications	<ul style="list-style-type: none"> ■ CE declaration ■ UL ■ EAC 			
Installation	<ul style="list-style-type: none"> ■ Indoor ■ There is one unique cut-out for all mounting positions and all slim models 			
Cooling characteristics				
Cooling power L35-L35	1100 W (3753 Btu/h)	1100 W (3753 Btu/h)	1500 W (5118 Btu/h)	1500 W (5118 Btu/h)
Cooling power L35-L50	860 W (2934 Btu/h)	860 W (2934 Btu/h)	1150 W (3924 Btu/h)	1150 W (3924 Btu/h)
Air flow of the internal circuit (enclosure)	860 m³/h	860 m³/h	860 m³/h	860 m³/h
Air flow of the external circuit (ambient)	860 m³/h	860 m³/h	860 m³/h	860 m³/h
Thermostat type	Electronic	Electronic	Electronic	Electronic
Temperature range internal circuit (enclosure)	+20 ... +46°C	+20 ... +46°C	+20 ... +46°C	+20 ... +46°C
Maximum outside temperature	+50°C	+50°C	+50°C	+50°C
Temperature range external circuit (ambient)	+5 ... +50°C	+5 ... +50°C	+5 ... +50°C	+5 ... +50°C
Type of cooling gas	R134a	R134a	R134a	R134a
Cooling gas weight	0.5 kg	0.5 kg	0.46 kg	0.46 kg
Maximum pressure cooling circuit	28 bar	28 bar	28 bar	28 bar
External circuit filter	Optional, see page 55	Optional, see page 55	Optional, see page 55	Optional, see page 55
Electric characteristics				
Input voltage	1 x 230 V / 50-60 Hz*	2 x 400-460 V / 50-60 Hz*	1 x 230 V / 50-60 Hz*	2 x 400-460 V / 50-60 Hz*
Starting / Rated Intensity	11 A / 4.8 A	8.5 A / 2.7 A	18 A / 5.7 A	11 A / 3.2 A
Power consumption absorbed L35-L35	660 W	660 W	840 W	840 W
Power consumption absorbed L35-L50	790 W	790 W	970 W	970 W
Energy efficiency ratio (EER) L35-L35	1.7	1.7	1.8	1.8
Thermal protection recommended (fuse)	T6 A	T4 A	T10 A	T6 A
Physical characteristics				
External dimensions (H x W x D)	495 x 1696 x 195 mm	495 x 1696 x 195 mm	495 x 1696 x 195 mm	495 x 1696 x 195 mm
Protection degree IP internal /external	IP55 / IP34	IP55 / IP34	IP55 / IP34	IP55 / IP34
Noise level	64 dB	64 dB	66 dB	66 dB
Weight of unit	50 kg	52 kg	55 kg	57 kg
References				
Steel UL	NSYCUS1K1UL	NSYCUS1K12P4UL	NSYCUS1K5UL	NSYCUS1K52P4UL
Stainless steel UL	NSYCUSX1K1UL	NSYCUSX1K12P4UL	NSYCUSX1K5UL	NSYCUSX1K52P4UL

* Certification UL only 60 Hz.

Thermal management system

Characteristics



PB002632-17

D

	2000 W (6824 Btu/h)	2000 W (6824 Btu/h)	2500 W (8530 Btu/h)	2500 W (8530 Btu/h)	3200 W (10919 Btu/h)	3200 W (10919 Btu/h)
	1550 W (5289 Btu/h)	1550 W (5289 Btu/h)	1850 W (6312 Btu/h)	1850 W (6312 Btu/h)	2500 W (8530 Btu/h)	2500 W (8530 Btu/h)
	860 m ³ /h	860 m ³ /h	1450 m ³ /h	1450 m ³ /h	1450 m ³ /h	1450 m ³ /h
	1050 m ³ /h	1050 m ³ /h	1450 m ³ /h	1450 m ³ /h	1450 m ³ /h	1450 m ³ /h
	Electronic	Electronic	Electronic	Electronic	Electronic	Electronic
	+20 ... +46°C	+20 ... +46°C	+20 ... +46°C	+20 ... +46°C	+20 ... +46°C	+20 ... +46°C
	+50°C	+50°C	+50°C	+50°C	+50°C	+50°C
	+5 ... +50°C	+5 ... +50°C	+5 ... +50°C	+5 ... +50°C	+5 ... +50°C	+5 ... +50°C
	R134a	R134a	R134a	R134a	R134a	R134a
	0.51 kg	0.59 kg	1.2 kg	1.2 kg	0.85 kg	1.25 kg
	28 bar	28 bar	28 bar	28 bar	28 bar	28 bar
	Optional, see page 55	Optional, see page 55	Optional, see page 55	Optional, see page 55	Optional, see page 55	Optional, see page 55
	1 x 230 V / 60 Hz	3 x 400 V / 50-60 Hz (3 x 460 V / 60 Hz)*	1 x 230 V / 60 Hz	3 x 400 V / 50-60 Hz (3 x 460 V / 60 Hz)*	1 x 230 V / 60 Hz	3 x 400 V / 50-60 Hz (3 x 460 V / 60 Hz)*
	24 A / 6.5 A	10 A / 2.1 A	35 A / 10.5 A	14 A / 2.9 A	37 A / 10.5 A	18 A / 3.1 A
	1020 W	1060 W	1340 W	1270 W	1720 W	1650 W
	1160 W	1270 W	1580 W	1510 W	2000 W	1980 W
	2.0	1.9	1.9	2.0	1.9	1.9
	T10 A	T6 A	T16 A	T6 A	T16 A	T6 A
	495 x 1696 x 195 mm	495 x 1696 x 195 mm	495 x 1696 x 235 mm	495 x 1696 x 235 mm	495 x 1696 x 235 mm	495 x 1696 x 235 mm
	IP55 / IP34	IP55 / IP34	IP55 / IP34	IP55 / IP34	IP55 / IP34	IP55 / IP34
	67 dB	67 dB	69 dB	69 dB	69 dB	69 dB
	63 kg	65 kg	80 kg	82 kg	81 kg	83 kg
	NSYCUS2KUL	NSYCUS2K3P460UL	NSYCUS2K5UL	NSYCUS2K53P4UL	NSYCUS3K2UL	NSYCUS3K23P4UL
	NSYCUSX2KUL	NSYCUSX2K3P4UL	NSYCUSX2K5UL	NSYCUSX2K53P4UL	NSYCUSX3K2UL	NSYCUSX3K23P4UL

Thermal management system

Dimensions

New

Cooling units

Side-mounting models: dimensions and cut-outs

NSYCU300H

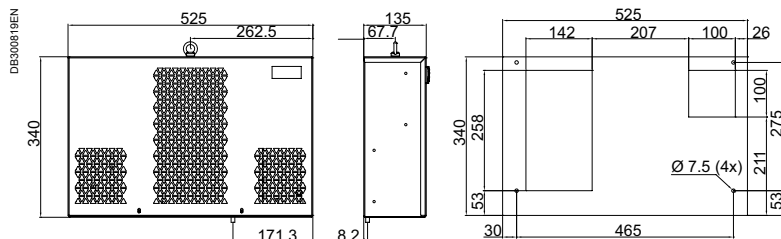

NSYCU•400•

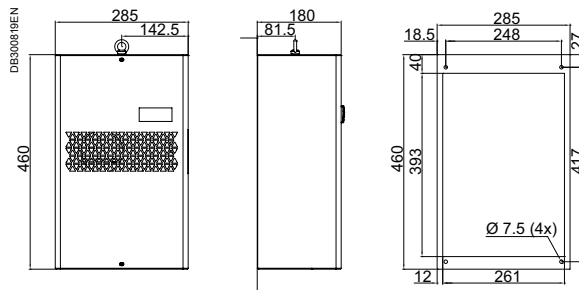

NSYCU•600•

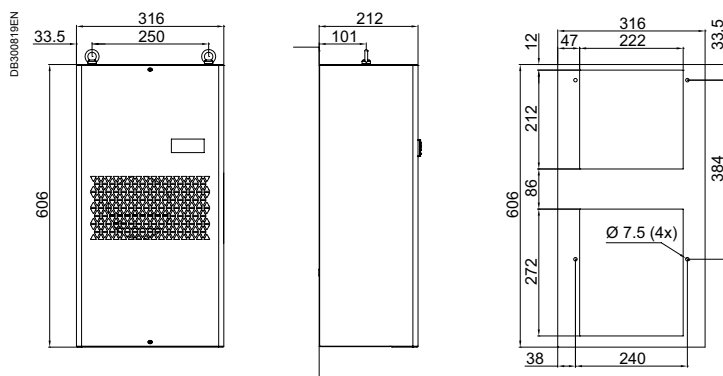

NSYCU•800• - NSYCU•1K•

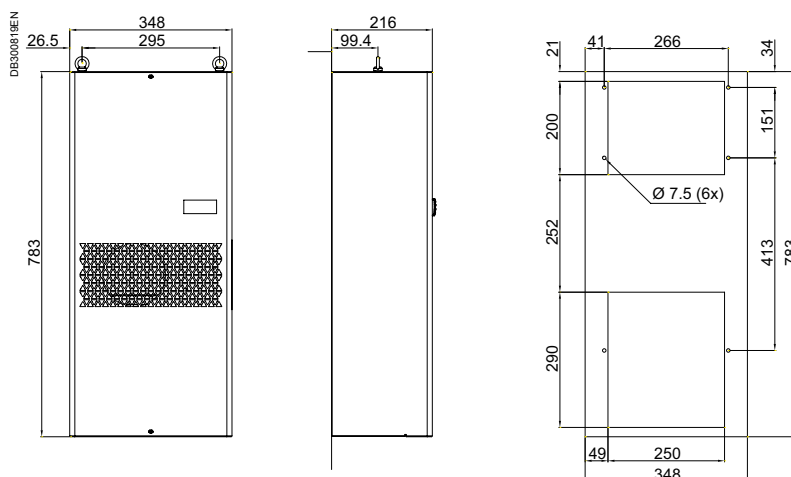

Units of measurement are mm.

Thermal management system

Dimensions

New

NSYCU••1K2•• - NSYCU••1K6•• - NSYCU••2K••

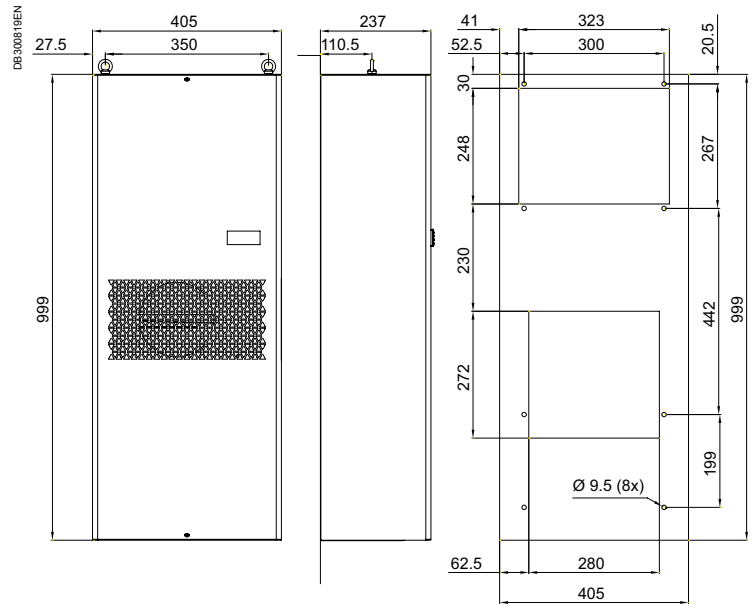

NSYCU••3K3P4•• - NSYCU••4K3P4••

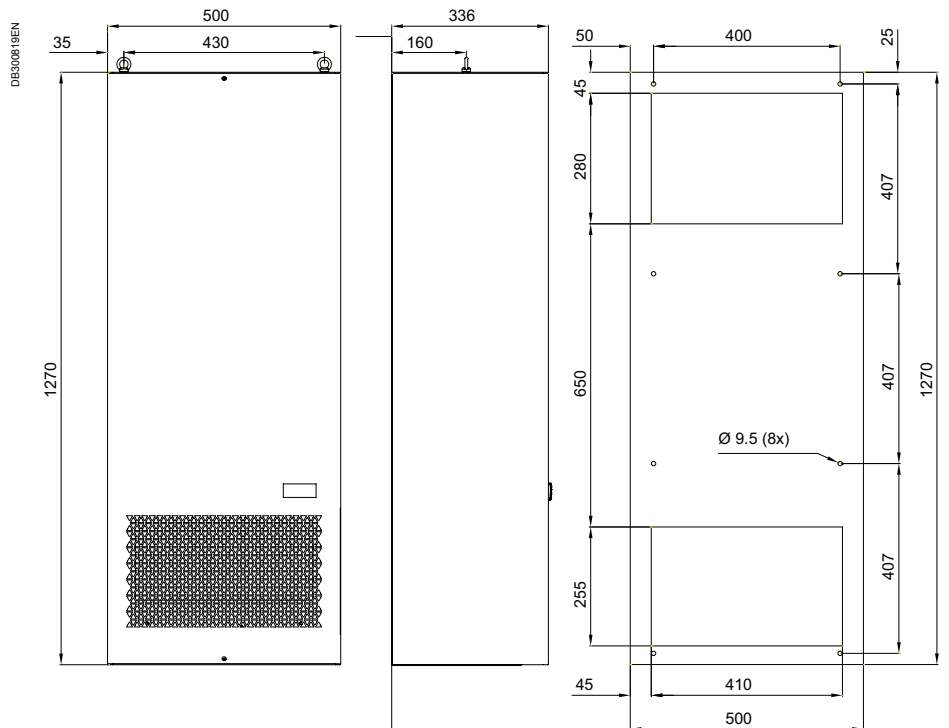

Units of measurement are mm.

Thermal management system

Dimensions

New

Cooling units

Top-mounting models: dimensions and cut-outs

NSYCU••400R••

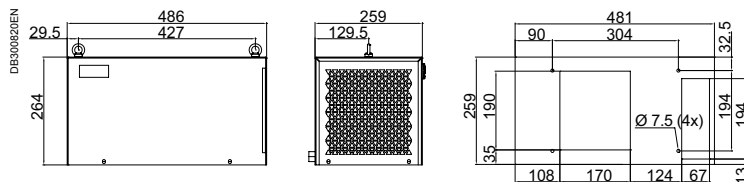

NSYCU••800R••

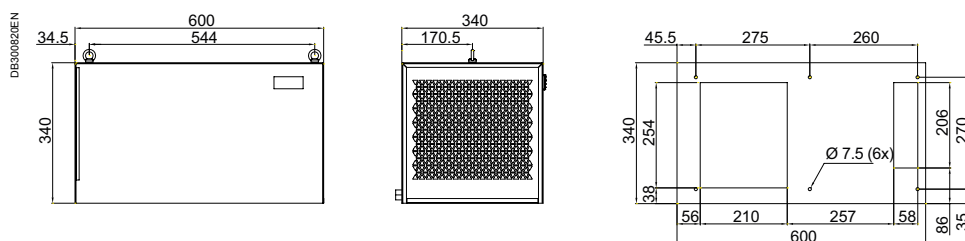

NSYCU••1K2R•• - NSYCU••1K5R•• - NSYCU••2K••R••

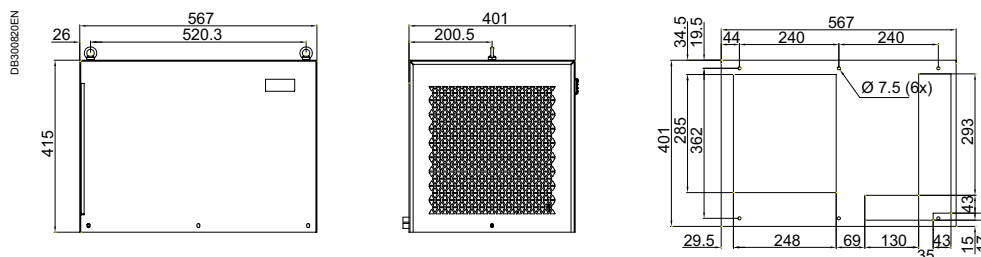

NSYCU••3K3P4R•• - NSYCU••4K3P4R••

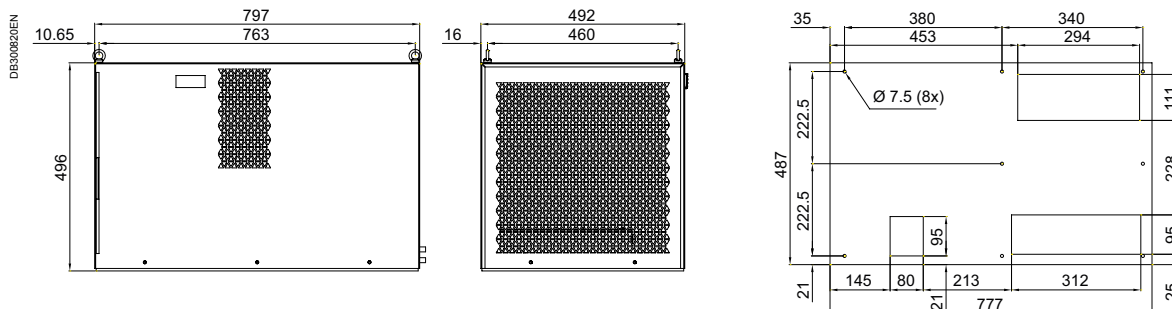

Units of measurement are mm.

Thermal management system

Dimensions

New

Slim cooling units

NSYCUS•1K1• - NSYCUS•1K5• - NSYCUS•2K•

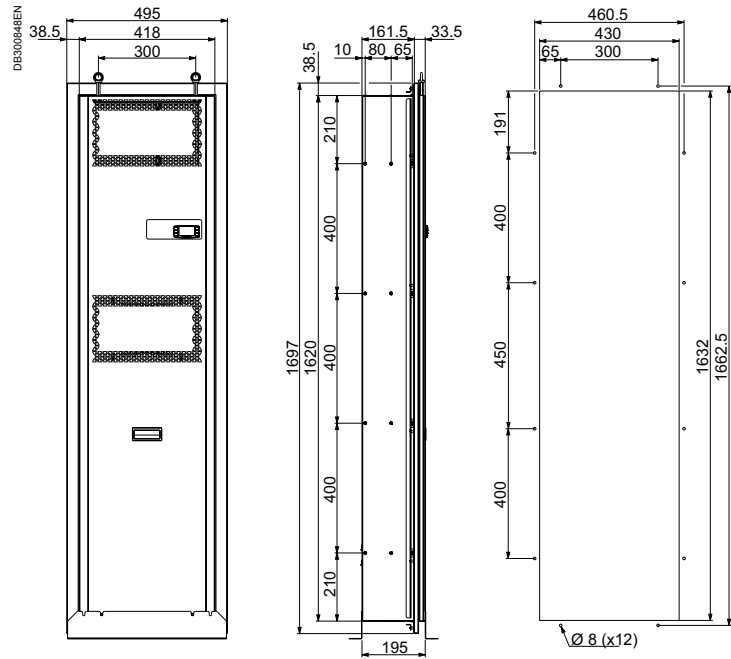

NSYCUS•2K5• - NSYCUS•3K2•

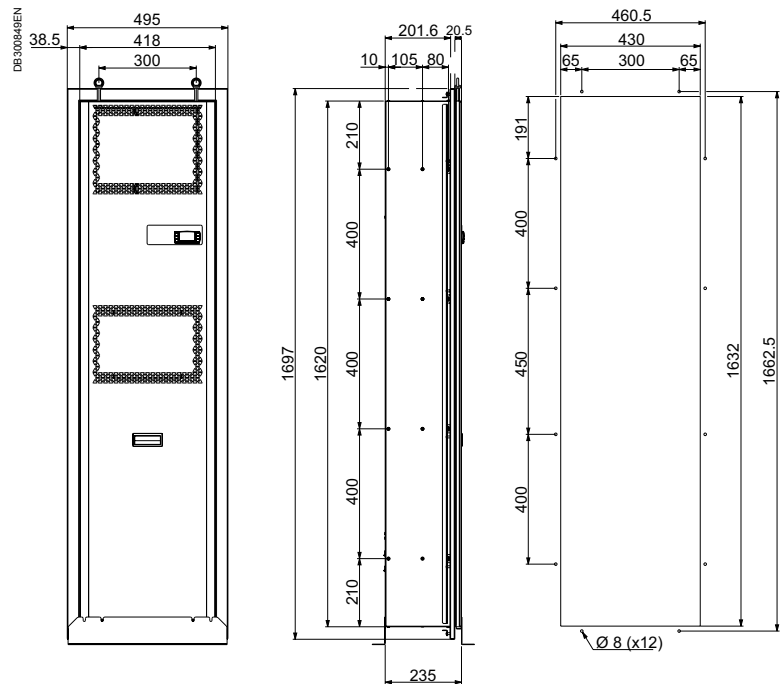

Units of measurement are mm.

Thermal management system

Accessories

New



PB502616-22

Characteristics	Cooling units					
	IEC			UL		
	Steel	Stainless steel	Outdoor	Steel	Stainless steel	
Material						
Colour						
Installation						
Supply						
References						
Cooling units						
Side-mounting models	NSYCU300H	-	-	-	-	
	NSYCU400	NSYCUX400	NSYCUHD400	NSYCU400UL	-	
	NSYCU600	NSYCUX600	NSYCUHD600	NSYCU600UL	NSYCUX600UL	
	NSYCU800	NSYCUX800	NSYCUHD800	NSYCU800UL	NSYCUX800UL	
	NSYCU1K	NSYCUX1K	NSYCUHD1K	NSYCU1KUL	NSYCUX1KUL	
	NSYCU1K2P4	NSYCUX1K2P4	NSYCUHD1K2P4	NSYCU1K2P4UL	NSYCUX1K2P4UL	
	NSYCU1K2	NSYCUX1K2	-	NSYCU1K2UL	NSYCUX1K2UL	
	NSYCU1K22P4	NSYCUX1K22P4	-	-	-	
	NSYCU1K6	NSYCUX1K6	NSYCUHD1K6	NSYCU1K6UL	NSYCUX1K6UL	
	NSYCU1K62P4	NSYCUX1K62P4	NSYCUHD1K62P4	NSYCU1K62P4UL	NSYCUX1K62P4UL	
	NSYCU2K	NSYCUX2K	-	NSYCU2KUL	NSYCUX2KUL	
	NSYCU2K3P4	NSYCUX2K3P4	NSYCUHD2K3P4	NSYCU2K3P4UL	NSYCUX2K3P4UL	
	NSYCU3K3P4	NSYCUX3K3P4	NSYCUHD3K3P4	NSYCU3K3P4UL	NSYCUX3K3P4UL	
	NSYCU4K3P4	NSYCUX4K3P4	NSYCUHD4K3P4	NSYCU4K3P4UL	NSYCUX4K3P4UL	
	Floor-standing models	NSYCU6K3P4	-	-	-	-
		NSYCU6K3P460	-	-	-	-
		NSYCU8K3P4	-	-	-	-
		NSYCU8K3P460	-	-	-	-
		NSYCU10K3P4	-	-	-	-
NSYCU10K3P460		-	-	-	-	
NSYCU15K3P4		-	-	-	-	
NSYCU15K3P460	-	-	-	-		
Top-mounting model	NSYCU400R	NSYCUX400R	-	NSYCU400RUL	-	
	NSYCU800R	NSYCUX800R	-	NSYCU800RUL	-	
	NSYCU1K2R	NSYCUX1K2R	-	NSYCU1K2RUL	-	
	NSYCU1K5R	NSYCUX1K5R	-	NSYCU1K5RUL	-	
	NSYCU2K3P4R	NSYCUX2K3P4R	-	NSYCU2K3P4RUL	-	
	NSYCU2KR	NSYCUX2KR	-	-	-	
	NSYCU3K3P4R	NSYCUX3K3P4R	-	NSYCU3K3P4RUL	-	
	NSYCU4K3P4R	NSYCUX4K3P4R	-	NSYCU4K3P4RUL	-	
	Slim model	-	-	-	NSYCUS1K1UL	NSYCUSX1K1UL
		-	-	-	NSYCUS1K12P4UL	NSYCUSX1K12P4UL
-		-	-	NSYCUS1K5UL	NSYCUSX1K5UL	
-		-	-	NSYCUS1K52P4UL	NSYCUSX1K52P4UL	
-		-	-	NSYCUS2KUL	NSYCUSX2KUL	
-		-	-	NSYCUS2K3P460UL	NSYCUSX2K3P4UL	
-		-	-	NSYCUS2K5UL	NSYCUSX2K5UL	
-		-	-	NSYCUS2K53P4UL	NSYCUSX2K53P4UL	
-		-	-	NSYCUS3K2UL	NSYCUSX3K2UL	
-		-	-	NSYCUS3K23P4UL	NSYCUSX3K23P4UL	

Thermal management system

Accessories

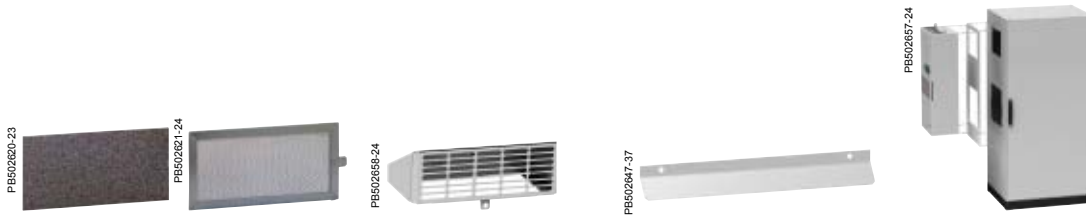

Filters		Canopy for ClimaSys CU		Internal deflector	Retrofit panel	
	Plastic filter not recommended for outdoor models.	Metallic filter recommended for outdoor models.	This canopy is highly recommended for harsh indoor environments to protect from ingress of dust.	Deflects the air inside the enclosure.	Panel that enable to mount a new ClimaSys CU units by replacement of old Schneider Electric cooling systems.	
	Polyurethane	Micro-stretched aluminium	Painted zinc coated	Zinc coated	Metal painted	
	Black	-	RAL 7035	RAL 7035	RAL 7035	
	Indoor	Indoor or outdoor	Indoor	Indoor or outdoor	Indoor	
	5 units	1 unit	1 unit	1 unit with fixing elements	1 unit	
						Old Schneider Electric cooling system



-	-	-	-	-	-	-
NSYCUF400	NSYCUFX400	NSYCUCN400HD	NSYCU400	NSYCURFT400	NSYCU240W230VL	NSYCU370W230VL
NSYCUF600	NSYCUFX600	NSYCUCN600HD	NSYCU600	-	-	-
NSYCUF800T1K	NSYCUFX800T1K	NSYCUCN800T1KHD	NSYCU800T1K	NSYCURFT800T1K	NSYCU760W230VL	NSYCU1100W230L
NSYCUF800T1K	NSYCUFX800T1K	NSYCUCN800T1KHD	NSYCU800T1K	NSYCURFT800T1K	NSYCU1050W230VL	-
NSYCUF800T1K	NSYCUFX800T1K	NSYCUCN800T1KHD	NSYCU1K2T2K	NSYCURFT800T1K	-	-
NSYCUF1KT2K	NSYCUFX1K2T2K	NSYCUCN1K2T2KHD	NSYCU1K2T2K	-	-	-
NSYCUF1KT2K	NSYCUFX1K2T2K	NSYCUCN1K2T2KHD	NSYCU1K2T2K	-	-	-
NSYCUF1KT2K	NSYCUFX1K2T2K	NSYCUCN1K2T2KHD	NSYCU1K2T2K	NSYCURFT1K6T2K	NSYCUE1400W230L	NSYCU1650W230VL
NSYCUF1KT2K	NSYCUFX1K2T2K	NSYCUCN1K2T2KHD	NSYCU1K2T2K	NSYCURFT1K6T2K	NSYCUE1400W400L	-
NSYCUF1KT2K	NSYCUFX1K2T2K	NSYCUCN1K2T2KHD	NSYCU1K2T2K	-	-	-
NSYCUF1KT2K	NSYCUFX1K2T2K	NSYCUCN1K2T2KHD	NSYCU1K2T2K	NSYCURFT1K6T2K	NSYCU1800W400VL	NSYCU1800W400L
NSYCUF3KT4K	NSYCUFX3KT4K	NSYCUCN3KT4KHD	NSYCU3KT4K	NSYCURFT3KT4K	NSYCU2500W400VL	NSYCU4000W400VL
NSYCUF3KT4K	NSYCUFX3KT4K	NSYCUCN3KT4KHD	NSYCU3KT4K	NSYCURFT3KT4K	NSYCU4000W400VL	-
NSYCUF6K	NSYCUFX6K	-	-	-	-	-
NSYCUF6K	NSYCUFX6K	-	-	-	-	-
NSYCUF8KT10K	NSYCUFX8KT10K	-	-	-	-	-
NSYCUF8KT10K	NSYCUFX8KT10K	-	-	-	-	-
NSYCUF8KT10K	NSYCUFX8KT10K	-	-	-	-	-
NSYCUF8KT10K	NSYCUFX8KT10K	-	-	-	-	-
NSYCUF15K	NSYCUFX15K	-	-	-	-	-
NSYCUF15K	NSYCUFX15K	-	-	-	-	-
NSYCUF400R	NSYCUFX400R	-	-	-	-	-
NSYCUF800R	NSYCUFX800R	-	-	-	NSYCURFT800R	NSYCU760W230VR
NSYCUF1K2T2KR	NSYCUFX1K2T2KR	-	-	-	NSYCURFT1K2T2K	NSYCU1050W230VR
NSYCUF1K2T2KR	NSYCUFX1K2T2KR	-	-	-	NSYCURFT1K2T2K	NSYCUE1400W230R
						NSYCU1460W230VR
						NSYCU1650W230VR
NSYCUF1K2T2KR	NSYCUFX1K2T2KR	-	-	-	NSYCURFT1K2T2K	NSYCUE1800W400R
						NSYCU2000W400VR
NSYCUF1K2T2KR	NSYCUFX1K2T2KR	-	-	-	-	-
NSYCUF3KT4KR	NSYCUFX3KT4KR	-	-	-	NSYCURFT3K	NSYCU2450W400VR
						NSYCU3100W400VR
NSYCUF3KT4KR	NSYCUFX3KT4KR	-	-	-	-	-
NSYCUF1K1T2KS	NSYCUFX1K1T2KS	-	NSYCU1K1T1K5	-	-	NSYCUB1100W230S
NSYCUF1K1T2KS	NSYCUFX1K1T2KS	-	NSYCU1K1T1K5	-	-	NSYCUB1100W400S
NSYCUF1K1T2KS	NSYCUFX1K1T2KS	-	NSYCU1K1T1K5	-	-	NSYCUB1500W230S
NSYCUF1K1T2KS	NSYCUFX1K1T2KS	-	NSYCU1K1T1K5	-	-	NSYCUB1500W400S
NSYCUF1K1T2KS	NSYCUFX1K1T2KS	-	NSYCU1K1T1K5	-	-	NSYCUB2200W230S
NSYCUF1K1T2KS	NSYCUFX1K1T2KS	-	NSYCU1K1T1K5	-	-	NSYCUB2200W400S
NSYCUF1K1T2KS	NSYCUFX1K1T2KS	-	NSYCU1K1T1K5	-	-	NSYCUB2700W230S
NSYCUF1K1T2KS	NSYCUFX1K1T2KS	-	NSYCU1K1T1K5	-	-	NSYCUB2700W400S
NSYCUF1K1T2KS	NSYCUFX1K1T2KS	-	NSYCU1K1T1K5	-	-	NSYCUB2700W230S
NSYCUF1K1T2KS	NSYCUFX1K1T2KS	-	NSYCU1K1T1K5	-	-	NSYCUB2700W400S

Thermal management system

Introduction

➤ Ultra thin resistance heaters have been designed to resolve condensation problems in the most complex installations. Is your enclosure short of space? Does your mounting plate make it impossible to install a conventional resistor? Do you not want to take out the equipment? Discover the benefits of this new offer and its numerous mounting solutions.



Ultra thin resistance heaters

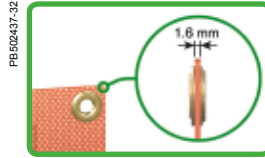

Small size (thickness = 1.6 mm)

The space saving available for the equipment compared with a conventional resistor can be up to 30%.



Heat and safety

The heat is distributed over the whole surface and does not exceed 70°C. This temperature allows devices next to the heater to be handled safely.



Multiple options for fixing

Innovative quick-fixing system using Velcro pads (no need for a tool!) or with basic fixing accessories (screw + spacer). These systems make it easy to move the heater if necessary.



Numerous positions for installation

These heaters are so slim and flexible they can be installed in a variety of positions:

- Vertically on side panels
- On the mounting plate.



Energy efficiency

Ultra thin resistance heaters are ohmic: they therefore have a low starting current.



No interference emissions

These resistors can be installed near electronic equipment to guarantee optimum heat.

Thermal management system

Characteristics and selection guide

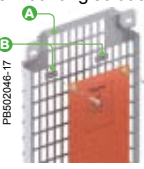
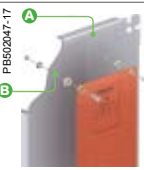
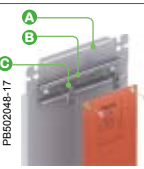
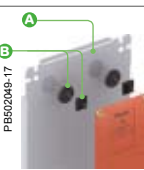
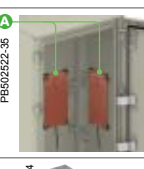
Ultra thin resistance heaters	
Description	Flexible, ultra thin resistance heaters to be installed inside the enclosure
Material	Silicon reinforced with fibreglass
Colour	Red (heaters), black (wires)
Certifications	VDE, LR
Installation	<p>5 mounting solutions :</p> <div style="display: flex; justify-content: space-between;"> <div style="width: 45%;">  <p>PB502046-17</p> </div> <div style="width: 50%;"> <p>1 - On a Telequick mounting plate A: Telequick mounting plate, ref. NSYMR●●●● B: Telequick nuts, ref. AF1EA●, supplied with the mounting kit</p> </div> </div> <div style="display: flex; justify-content: space-between;"> <div style="width: 45%;">  <p>PB502047-17</p> </div> <div style="width: 50%;"> <p>2 - On plain or micro-perforated mounting plate with fixing hardware A: Mounting plate, ref. NSYMM●●●● B: Fixing hardware included in the mounting kit</p> </div> </div> <div style="display: flex; justify-content: space-between;"> <div style="width: 45%;">  <p>PB502048-17</p> </div> <div style="width: 50%;"> <p>3 - On DIN rail A: Mounting plate, ref. NSYMM●●●● B: Symmetrical DIN rail, ref. NSYSDR●●●● C: Clip-on nuts, ref. AF1CG●, supplied with the mounting kit</p> </div> </div> <div style="display: flex; justify-content: space-between;"> <div style="width: 45%;">  <p>PB502049-17</p> </div> <div style="width: 50%;"> <p>4 - On plain mounting plate with selfadhesive Velcro pads A: Mounting plate, ref. NSYMM●●●● B: Self-adhesive Velcro pad and plastic fixings supplied with the mounting kit</p> </div> </div> <div style="display: flex; justify-content: space-between;"> <div style="width: 45%;">  <p>PB502052-35</p> </div> <div style="width: 50%;"> <p>5 - On wall with self-adhesive Velcro pads A: Self-adhesive Velcro pads and plastic fixings supplied in the mounting kit</p> </div> </div>



Ultra thin resistance heaters*						
Power (W)	Voltage (V)	Inrush current (A)	Height (mm)	Width (mm)	Depth (mm)	References
10	120	0.08	130	250	1.6	NSYCRS10W120V
	240	0.04	130	250	1.6	NSYCRS10W240V
25	120	0.21	130	250	1.6	NSYCRS25W120V
	240	0.10	130	250	1.6	NSYCRS25W240V
50	120	0.42	200	320	1.6	NSYCRS50W120V
	240	0.21	200	320	1.6	NSYCRS50W240V
100	120	0.83	280	450	1.6	NSYCRS100W120V
	240	0.42	280	450	1.6	NSYCRS100W240V
200	120	1.67	400	650	1.6	NSYCRS200W120V
	240	0.83	400	650	1.6	NSYCRS200W240V

* Ultra thin resistance heaters can be manufactured with different dimensions and power ratings than those indicated above. Please contact us.

Thermal management system

Introduction

➤ The resistance heaters prevent the formation of condensation and guarantee the ideal temperature for the correct operation of the electronic components in the enclosure.

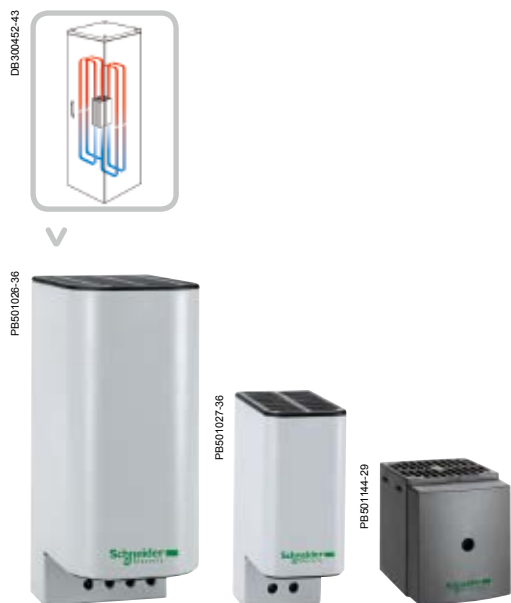

Insulated PTC heaters



Large range of power levels

- 2 versions: by natural convection and with fan.
- AC or DC power supply.
- 7 power levels, from 10 W to 550 W.



Innovating design



Easy installation and connection

- Reduced dimensions.
- Quick electric connection by terminal board.
- No maintenance required.
- Direct clipping onto a 35 mm DIN rail.



Safety

- The protection prevents direct contact with the aluminium radiator.
- Electric protection device with terminal block cover.
- Equipped with a PTC-type heater.
- Surface temperature lower than 70°C.

High thermal efficiency

- The configuration of the aluminium profile produces a "chimney" effect: high natural convection.
- Low power consumption thanks to self-control of the PTC-type heater.



Models with fan

- The heaters equipped with a fan ensure circulation of the air and a uniform temperature inside the enclosure.
- High-flow, silent fan.



Certifications

- CE marking.
- Range compliant with UL and VDE.

Thermal management system

Introduction



Aluminium PTC heaters



Resistance heaters equipped with a PTC-type sensor

The resistance heaters for electrical and electronic enclosures are equipped with PTC-type heating devices (Positive Temperature Coefficient).

Thanks to these heaters:

- The surface temperature stabilises at 75°C when the ambient temperature is -5°C.
- Power consumption is reduced.

Improved convection

The design of the profile of the resistance heaters produces a "chimney" effect, leading to increased natural convection and maintaining an even temperature inside the enclosure.



Quick fixing

The resistance heaters are fixed by means of fixing clips to a 35 mm DIN rail.



Connection cables

The 10 and 20 W heaters are equipped with a 2 x 0.75 x 300 mm power cord.



Connection terminal boards

Heaters with a power of more than 20 W are equipped with a connection terminal board.



Models with fan

Models of 250 to 400 W with fan.



Thermal management system

Characteristics

Insulated PTC resistance heaters

Characteristics

Material

Conditions of use

Ingress protection rating

Certifications

Power at 0°C	Voltage	Surface temperature	Electric connection	Mounting
10 W	110-250 V AC	<70°C, except for the top protection grille	2 poles, 2.5 mm ²	Quick by clip on a 35-mm DIN rail
10 W	12-24 V DC			
20 W	110-250 V AC			
20 W	12-24 V DC			
55 W	110-250 V AC	<70°C, except for the top protection grille	4 poles, 2.5 mm ²	By clip on a 35-mm DIN rail
55 W	12-24 V DC			
55 W	270-420 V AC			
100 W	110-250 V AC			
100 W	12-24 V DC			
100 W	270-420 V AC			
147 W	110-250 V AC			
147 W	12-24 V DC			
177 W	230 V AC / 50-60 HZ	Max. 50°C in the enclosure, 100°C on the top protection grille, (for an ambient temperature of 20°C / 68°F)	2 poles, 2.5 mm ²	By clip on a 35-mm DIN rail

Thermal management system

Characteristics



Insulated PTC heater	Insulated ventilated PTC heaters
----------------------	----------------------------------

- | | |
|---|---|
| <ul style="list-style-type: none"> ■ Compact resistance heater preventing the formation of condensation or frost. ■ Designed to ensure good natural convection and high thermal efficiency. | <ul style="list-style-type: none"> ■ The heaters must be installed with a thermal controller (see selection table on pages 64 and 65) to control the temperature or the humidity inside the enclosure ■ The enclosure must be sealed to prevent the entry of air from the outside ■ An electrical protection device must be installed on the supply side of the unit ■ Operating position: vertical ■ Operating temperature: -40...+70°C; -10...+158°F |
|---|---|

IP20	VDE and UL	Cover: UL 94 V-0 plastic
		Class II (double insulated)

References		
NSYCR10WU2C	-	-
NSYCR10WU1C	-	-
NSYCR20WU2C	-	-
NSYCR20WU1C	-	-
-	NSYCR50WU2C	-
-	NSYCR50WU1C	-
-	NSYCR50WU3C	-
-	NSYCR100WU2C	-
-	NSYCR100WU1C	-
-	NSYCR100WU3C	-
-	NSYCR150WU2C	-
-	NSYCR150WU1C	-

		NSYCR170W230VVC
--	--	-----------------

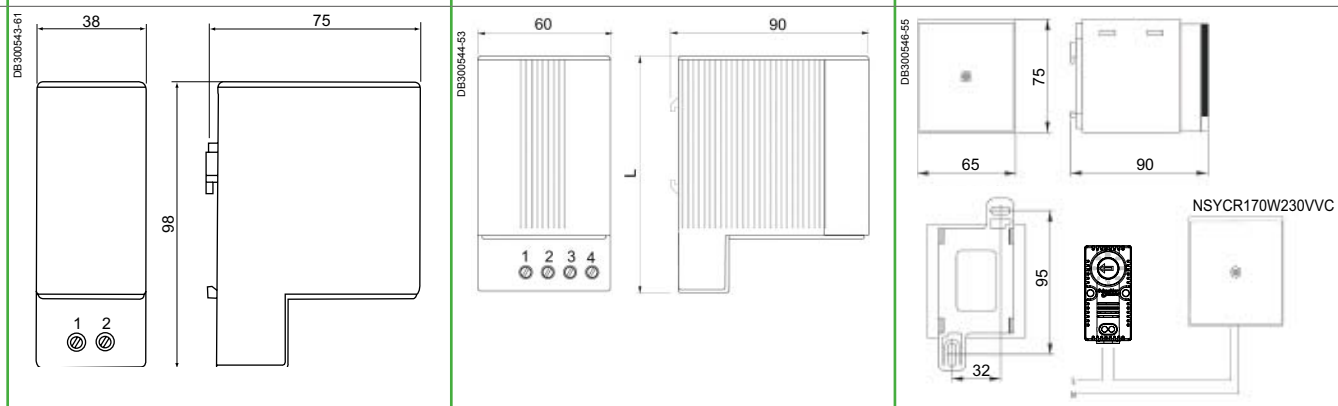

F

Thermal management system

Characteristics, selection guide

Aluminium PTC heaters

PB501146-23



PB501026-21



PB501146-46



NSYCRS200W230V

Characteristics		Aluminium PTC heaters	Resistive heaters with fan
		<ul style="list-style-type: none"> Extruded aluminium body. Surface temperature limited to 75°C when the ambient temperature is -5°C. Heaters equipped with a power cable with a length of 500 mm with silicon insulation, or with a connection terminal block. 	
Conditions of use		<ul style="list-style-type: none"> The heaters must be installed with a thermal controller to control the temperature or the humidity inside the enclosure The enclosure must be sealed to prevent the entry of air from the outside An electrical protection device must be installed on the supply side of the unit 	
Power (W)	Voltage (V)	References	
Power cord			
10	12-24 DC	NSYCR10WU1	-
	110-250 AC	NSYCR10WU2	-
20	12-24 DC	NSYCR20WU1	-
	110-250 AC	NSYCR20WU2	-
Terminal block			
20	270-420 AC	NSYCR20WU3	-
55	12-24 DC	NSYCR55WU1	-
	110-250 AC	NSYCR55WU2	-
	270-420 AC	NSYCR55WU3	-
90	12-24 DC	NSYCR100WU1	-
	110-250 AC	NSYCR100WU2	-
	270-420 AC	NSYCR100WU3	-
150	12-24 DC	NSYCR150WU1	-
	110-250 AC	NSYCR150WU2	-
	270-420 AC	NSYCR150WU3	-
250	115 AC	-	NSYCR250W115VV
	230 AC	-	NSYCR250W230VV
400	115 AC	-	NSYCR400W115VV
	230 AC	-	NSYCR400W230VV
200	115 AC	-	NSYCRS200W115V
	230 AC	-	NSYCRS200W230V

Thermofan

PB501154-12



NSYCRP1W230VTVC

Characteristics		Thermofan
		<ul style="list-style-type: none"> Combination of a resistance heater and an axial motor to ensure uniform heating of the enclosure. Fixing by clip on a DIN rail. Thermostat adjustable from 0...+60°C. Visual operation indicator.
Power (W)	Voltage (V)	References
Terminal block		
400/550	120 AC	NSYCRP1W120VTVC
	230 AC	NSYCRP1W230VTVC

Fixing accessories

PB501156-21



PB501156-21



Description	Supply	References
	Set of 5 studs	NSYCRAF
	Set of 5 studs and DIN rail	NSYCRAFD

Thermal management system

Introduction

Thermal control

> Mechanical thermostats

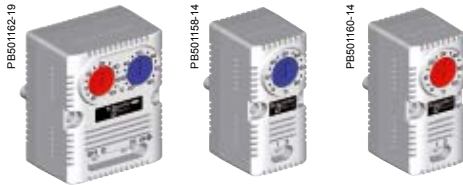

Mechanical and electronic thermostats

- Large range of temperature control.
- Small dimensions.
- Easily accessible terminals.

> Electronic thermostats



New

LED screen

Screen visible even in the dark.



New

New operational temperature range

-40°C ... +80°C.

Mechanical and electronic thermostats



The new quick-fixing systems

- On 35 mm DIN rail.

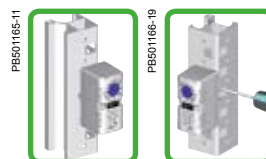

- On Spacial upright.



- On cross-rail.



- On mounting plate.



Certifications and declarations

- UL.
- CE.



Thermal management system

Characteristics, selection guide

Mechanical thermostats

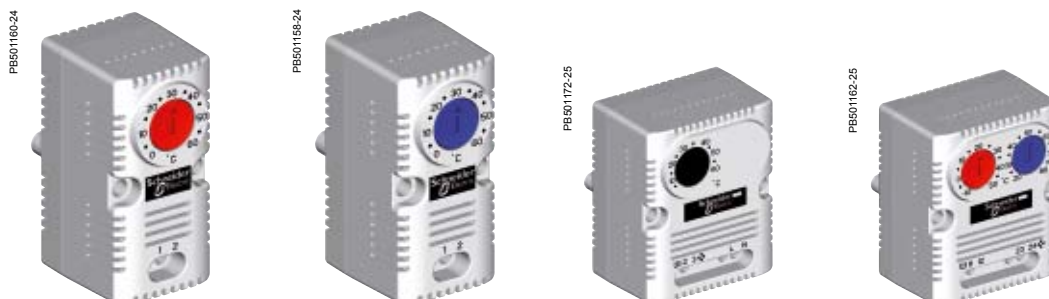

Characteristics	Thermostat	Thermostat	Thermostat	Double Thermostat				
	With NC contact	With NO contact	With NO/NC contact					
	Thermostat with NC Contact: ■ to control the stopping of a resistance heater when the temperature exceeds the displayed value. Thermostat with NO Contact: ■ to control the starting up of a fan when the temperature exceeds the displayed maximum value, ■ to control the temperature inside the enclosure by only starting up the fan when necessary, thus increasing the service life of the fan and reducing the clogging of the filter.							
Colour button	Red	Blue	Black	Red and blue				
Ingress protection rating	IP20	IP20	IP20	IP20				
Sensor element	Bimetal	Bimetal	Bimetal	Bimetal				
Contact	NC, forced rupture	NO, forced rupture	Inverse, forced rupture	NO / NC, forced rupture				
Contact resistance	< 10 mΩ	< 10 mΩ	< 10 mΩ	< 10 mΩ				
Service life	> 100,000 cycles	> 100,000 cycles	> 100,000 cycles	> 100,000 cycles				
Switching capacity	250 V AC; 10 A (resistive load) 120 V AC; 15 A (resistive load) 250 V AC/120 V AC 2 A (inductive load cos φ = 0.6) 30 W DC		250 V AC; 10 A (resistive load)	250 V AC; 10 A (resistive load) 120 V AC; 15 A (resistive load) 250 V AC/120 V AC 2 A (inductive load cos φ = 0.6) 30 W DC				
Max interrupting capacity with direct current	NA	NA	250 V AC 4 A (inductive load cos φ = 0.6) 30 W DC	NA				
Connection	Two 2.5 mm ² terminals	Two 2.5 mm ² terminals	Four 2.5 mm ² terminals	Six 2.5 mm ² terminals				
Mounting	By clip on 35 mm DIN rail	By clip on 35 mm DIN rail	By clip on 35 mm DIN rail	Clip on 35 mm DIN rail				
Enclosure	UL 94 V-0 plastic, light grey	UL 94 V-0 plastic, light grey	UL 94 V-0 plastic, light grey	UL 94 V-0 plastic, light grey				
Dimensions	60 x 33 x 43 mm	60 x 33 x 43 mm	67 x 50 x 44 mm	60 x 33 x 43 mm				
Weight	40 g	40 g	100 g	40 g				
Mounting position	Indifferent	Indifferent	Indifferent	Indifferent				
Operating temperature	-20...+80°C (-4...+176°F)	-20...+80°C (-4...+176°F)	-20...+80°C (-4...+176°F)	-20...+80°C (-4...+176°F)				
Hysteresis	7 K	7 K	7 K	7 K				
Temperature setting range	0...+60°C	0...+60°C	+5...+60°C	0...+60°C				
Display	°C °F	°C °F	°C °F	°C °F				
Max. command intensity	10 A 250 V		(NO) 5 A (NC) 10 A	(NO) 5 A (NC) 10 A				
References								
	NSYCCOTHC	NSYCCOTHCF	NSYCCOTHO	NSYCCOTHOF	NSYCCOTHI	NSYCCOTHIF	NSYCCOTHHD	NSYCCOTHDF
	<p>DB300547-31 L N Load = resistance</p>	<p>DB300547-31 L N Load = fan</p>	<p>DB300547-31 L N Load = fan</p>	<p>DB300548-33 L N Load (2): resistance Load (3): fan</p>	<p>DB300548-33 L N Load (2): resistance Load (3): fan</p>	<p>DB300548-32 N1 L1 A 11 12 B 23 24 N2 L2</p>	<p>DB300548-32 N1 L1 A 11 12 B 23 24 N2 L2</p>	<p>DB300548-32 N1 L1 A 11 12 B 23 24 N2 L2</p>

Thermal management system

Characteristics, selection guide

New

Electronic thermostats



Characteristics	Electronic thermostat	Electronic hygrotherm	Electronic hygrostat
	With LED screen Electronic temperature controller.	With LED screen Electronic temperature and humidity controller.	With LED screen Electronic humidity controller.
Ingress protection rating	IP20	IP20	IP20
Certification	UL / UR	UL / UR	UL / UR
Internal sensor element	Temperature sensor	Temperature sensor and humidity sensor	Humidity sensor
Contact	Free with zero potential	Free with zero potential	Free with zero potential
Connection	2 x 2.5 mm ² (input voltage) + 2 relays (2 x 2.5 mm ² + 2 x 2.5 mm ²)	2 x 2.5 mm ² (input voltage) + 2 relays (2 x 2.5 mm ² + 2 x 2.5 mm ²)	2 x 2.5 mm ² (input voltage) + 1 relay (2 x 2.5 mm ²)
Mounting	4 different methods: by DIN rail, Spacial SF profile, on VDI cross-rail or on mounting plate	4 different methods: by DIN rail, Spacial SF profile, on VDI cross-rail or on mounting plate	4 different methods: by DIN rail, Spacial SF profile, on VDI cross-rail or on mounting plate
Enclosure	UL 94 V-0 plastic, light grey	UL 94 V-0 plastic, light grey	UL 94 V-0 plastic, light grey
Operating temperature	-40°C...+80°C	-40°C...+80°C	-40°C...+80°C
Hysteresis	Programmed 2 K	Programmed 2 K and 3 %	3 %
Temperature setting range	-40°C...+80°C	-40°C...+80°C	-
Humidity setting range	-	20 %...80 %	20 %...80 %
Display	°C or °F	°C or °F or % RH	% RH
Max. command intensity	8 (5) A 230 V AC / 5 A 30 V DC	8 (5) A 230 V AC / 5 A 30 V DC	8 (5) A 230 V AC / 5 A 30 V DC

Voltage (type of current)	References
9-30 V (AC/DC)	NSYCCOTH30VID
110-127 V (AC)	NSYCCOTH120VID
220-240 V (AC)	NSYCCOTH230VID

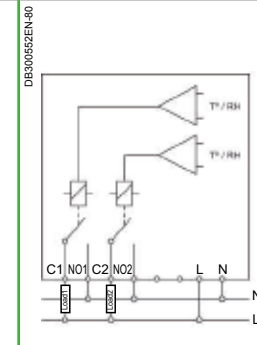
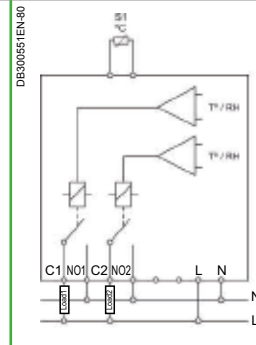
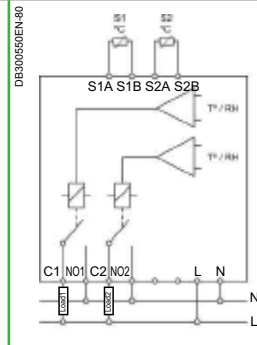

Characteristics	External temperature sensor (double insulation)
	<p>■ Sensor operation or reading range: -40°C...+150°C.</p> <p>Thermostat installation tips: the thermostat should be installed at the top of the enclosure (the hottest place). See the various operating modes of each thermostat to choose the one that best meets your needs.</p> <p>Hygrostat installation tips: the hygrostat should be installed at the bottom of the enclosure. 60% RH is the optimum value in the enclosure.</p>
Ingress protection rating	IP67
Fixing	On DIN rail, on Spacial SF profile, on VDI cross-rail, on mounting plate
Length of cable supplied (m)	3
	NSYCCASTE



Thermal management system

Introduction

New

PF6503400-70



Thermal conditions: a hot topic for enclosures

Temperature, humidity, and dew point all affect the performance of your electrical and electronic enclosures. Problem is, unless these environments are sized properly, thermal conditions will compromise reliability, safety, and efficiency, as well as the lifetime of your panels. **The precise knowledge of the thermal conditions is therefore indispensable to choose the most appropriate thermal management solution.**

PF6503408-53

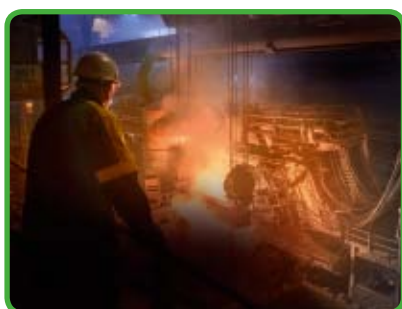

Threats to performance arise when:



Real environmental conditions are not known







Specifications are oversized



Excessive loads over-consume energy

How to use ClimaSys DT

Installation type	Need	
	What do you want to do?	
Greenfield	 New Project	Determine enclosure sizing needs and the correct thermal solution
Brownfield	 Power Dissipation verification	Measure the dissipation power of the installation in watts (enclosure without thermal solution installed)
	 Electronics H1 Health Test	Verify that there are no hot/ cold spots
	 Thermal Solution Test	Measure the efficiency of the existing thermal solution in a certain period of time
	 Humidity/ Condensation Test	Measure the risk of high humidity or condensation inside the enclosure

Thermal management system Introduction

New

ClimaSys DT: the solution to optimize the size of your enclosure

With ClimaSys DT dataloggers and EffiClima software, you can know with maximum accuracy the temperature evolution, humidity levels, and dew point inside and outside your control panels.

This data can then be analyzed with ProClima thermal software to determine the optimal thermal solution for each of your control panel installations.

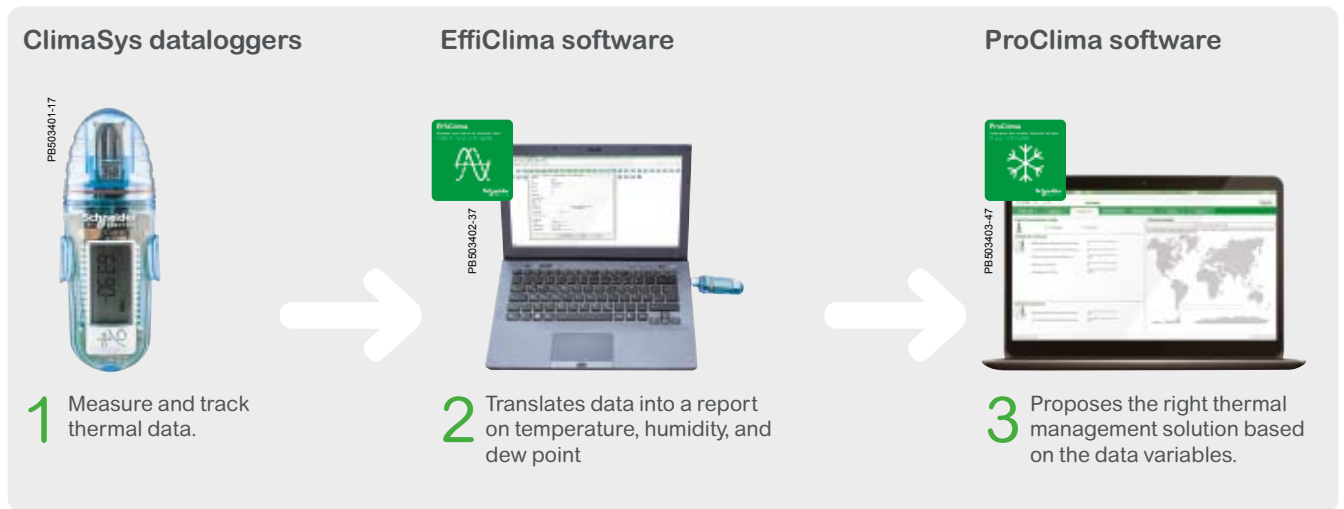

Selection of the dataloggers			
Variables to measure	How many dataloggers needed?	Model	Recommended installation
<ul style="list-style-type: none"> T outside RH outside 	1	DTH reference NSYDTEF32TRH	
<ul style="list-style-type: none"> T outside T inside 	2	DTT reference NSYDTEF32T or DT mini reference NSYDTEFSMT	
<ul style="list-style-type: none"> T inside 	1	DTT reference NSYDTEF32T or DT mini reference NSYDTEFSMT	
<ul style="list-style-type: none"> T outside T inside 	2	DTT reference NSYDTEF32T or DT mini reference NSYDTEFSMT	
<ul style="list-style-type: none"> T inside T outside HR inside/ outside 	2	DTH reference NSYDTEF32TRH	

H

Thermal management system

Introduction

New

> **ClimaSys DT** (Diagnostic Tools) dataloggers are an easy-to-use solution that enables users to:

- Access accurate and reliable thermal measurement data in design, commissioning, and exploitation phases
- Track fast or slow measurements
- Maintain continuity of service
- Optimize installations
- Detect hot and cold spots, and avoid condensation problems
- Determine if ventilation/cooling is possible.

PB503395-32



ClimaSys DTT

ClimaSys DT model records the temperature.

PB503396-37

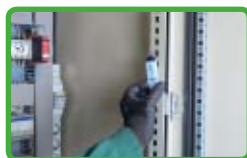

ClimaSys DTMinilog

ClimaSys DTMinilog model is a single-use recorder of temperature.

PB503397-39

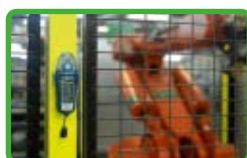

ClimaSys DTH

ClimaSys DTH model records the temperature and the relative humidity level, and determine the dew point.

+ Advantages

PB503276-50



ClimaSys DTT

- Time stamp/start/stop with magnet key
- Low power consumption for extended two-year battery life
- Easy data download to PC via USB connection
- USB firmware update
- QR code on dataloggers for easy online access to data sheets, videos, and other technical information

PB503404-95



ClimaSys DTH

- Time stamp/start/stop with magnet key
- Dew point reading on LCD and software
- Fast response time for RH sensor
- USB firmware update
- Low power consumption for extended battery life (up to two years)
- QR code on dataloggers for easy online access to data sheets, videos, and other technical information

PB503405-96



ClimaSys DTMinilog (single use)

- Activation button to start logging and mark time stamps
- Low power consumption for extended six-month battery life
- Easy data download to PC via USB connection
- USB firmware update
- Compact and easy to use
- QR code on dataloggers for easy online access to data sheets, videos, and other technical information

Thermal management system

Characteristics

New

Dataloggers



Characteristics		DTT	DTMinilog	DTH
		Temperature recorder	Single-use temperature recorder	Temperature, humidity and dew point recorder
Colour		Translucid	White	Translucid
Display Type		LCD display	-	LCD display
Dimensions	Height	111 mm	74 mm	111 mm
	Width	39 mm	30 mm	39 mm
	Depth	26 mm	13 mm	30 mm
Operating temperature		-40°C...80°C	-40°C...80°C	-40°C...80°C
Ingress protection rating		IP67 according to IEC 60529	IP68 according to IEC 60529	IP54 according to IEC 60529
Standard		EN 12830	EN 12830	EN 12830
Certification		CE	CE	CE
Fixing mode		Clip-on support	Cable tie	Clip-on support
Connector type		USB	USB	USB
Data recording		32 K	16 K	32 K
Temperature	Setting	-40°C...80°C	-40°C...80°C	-40°C...80°C
	Accuracy	±0.3°C	±0.5°C	±0.3°C
	Resolution	0.03°C	0.1°C	0.01°C
Humidity	Setting	-	-	5...95%
	Accuracy	-	-	±2%
	Resolution	-	-	0,5% HR
Battery	Type	Lithium CR2032 3 V	Lithium CR2032 3 V	Lithium CR2032 3 V
	Lifetime	Maximum 2 years	Maximum 6 months	Maximum 2 years
Composition		1	Set of 10 dataloggers	1
References		NSYDTEF32T	NSYDTEFSMT	NSYDTEF32TRH

Download EffiClima and ProClima free software



Discover more

ClimaSys DT video of the concept



e-brochure



H







Thermal management system

Method to determine a thermal management solution

Here is a simple method to help you choose a thermal solution. This method does not take into account the humidity level outside the enclosure.

Thermal balance

1 - Characteristics of the enclosure

Position of the enclosure according to IEC 890 ratio	Formula for calculating S (m ²)
 Accessible from every side	$S = 1.8 \times H \times (W + D) + 1.4 \times W \times D$
 Placed against a wall	$S = 1.4 \times W \times (H + D) + 1.8 \times D \times H$
 On the end when suited	$S = 1.4 \times D \times (H + W) + 1.8 \times W \times H$
 On the end when suited, placed against a wall	$S = 1.4 \times H \times (W + D) + 1.4 \times W \times D$
 In the middle when suited	$S = 1.8 \times W \times H + 1.4 \times W \times D + D \times H$
 In the middle when suited, placed against a wall	$S = 1.4 \times W \times (H + D) + D \times H$
 In the middle when suited, placed against a wall with the top covered	$S = 1.4 \times W \times H + 0.7 \times W \times D + D \times H$
	S = <input type="text" value=""/> m²

H = Height - W = Width - D = Depth

Example

Spacial reference NSYSF20840

H = 2000

W = 800

D = 400

Installation method:

Suitable enclosure placed against a wall.

S = 4.128 m²

2 - Thermal power dissipated by the operational components

Calculated as the sum of the power dissipated by each of the installed components.
If these are not known, use the ProClima software.

Pd = **W**

Assume that the switchgear dissipates 800 W.

Pd = 800 W

3 - Temperatures outside the enclosure

Maximum ambient temperature.

Minimum ambient temperature.

Te_{max} = **°C**

Te_{min} = **°C**

The temperature conditions are as follows:

Te_{max} = 35°C

Te_{min} = 15°C

4 - Average desired internal temperatures

They are defined by the nature of the components and the characteristics of the environment air

Maximum internal temperature

Minimum internal temperature

(maximum value between the dew point temperature and the minimum operating temperature of the devices)

Tid_{max} = **°C**

Tid_{min} = **°C**

Tid_{max} = 40°C

Tid_{min} = 29°C

5 - Temperature inside the enclosure without thermal management system

Max. internal temperature: $T_{fi_{max}} = \frac{Pd}{K \times S} + Te_{max}$

Min. internal temperature: $T_{fi_{min}} = \frac{Pd}{K \times S} + Te_{min}$

or K = 5.5 W/m²/°C for an enclosure made of painted sheet steel

K = 3.5 W/m²/°C for a polyester enclosure

K = 3.7 W/m²/°C for a stainless-steel enclosure

Tfi_{max} = **°C**

Tfi_{min} = **°C**

Tfi_{max} = 70°C

Tfi_{min} = 50°C

Calculation of thermal management power (Psyst)

a. Cooling systems:

$Psyst = Pd - K \times S \times (Tid_{max} - Te_{max}) = 686 \text{ w}$

b. Resistances:

Electrical installation operating constantly

$Psyst = K \times S \times (Tid_{min} - Te_{min}) - Pd$

Electrical installation operating discontinuously

$Psyst = K \times S \times (Tid_{min} - Te_{min})$

Thermal management system

Method to determine a thermal management solution

Choice of solution

1 - Cooling

Condition: Calculated temperature + 5°C > Temperature wanted.

Conditions	Solution	Advantages	Constraints
Cooling			
Temperature wanted in the enclosure at least 5°C higher than the ambient temperature. $T_{id_{max}} \geq T_{e_{min}} + 5\text{ }^{\circ}\text{C}$	Oversize the enclosure.	Economical. No maintenance. Easy to implement. IP of the installation maintained.	Relatively small savings. Larger overall dimensions.
	Natural airing (installation of ventilation air inlets).	Very economical. No maintenance. Easy, fast installation.	Quantity of heat removed small and dependent on the layout of the components. Deterioration of the IP (ingress of dust).
	Forced ventilation.	Economical. Easy to implement. Large quantity of heat removed. Temperature control possible.	Regular maintenance of filters IP slightly degraded. Ambient temperature $\leq 35\text{ }^{\circ}\text{C}$.
	Air-air exchanger.	Easy to implement. Easy to maintain. IP of the installation maintained. Regulated temperature.	Regular filter maintenance.
Temperature $T_{id_{max}}$ wanted in the enclosure 5°C less than the ambient temperature $T_{e_{max}}$. $T_{id_{max}} - 5\text{ }^{\circ}\text{C} \geq T_{e_{max}}$	Cooling unit.	Easy to implement. Large quantity of heat removed irrespective of the ambient temperature. IP of the installation maintained. Regulated temperature.	Regular filter maintenance Ambient temperature $\leq 55\text{ }^{\circ}\text{C}$. Installation of a system for removal of condensation water from the evaporator.
	Air-water exchanger.	Easy to implement. Large quantity of heat removed irrespective of the ambient temperature. IP of the installation maintained. Regulated temperature. No filter to be maintained.	Need for a water circuit. Consumption if supplied with town water.

$$(1) \text{ Flow rate (m}^3/\text{h)} = \varnothing = \frac{P_{syst}}{(T_{id_{max}} - T_{e_{max}})} \times 3.1 \text{ (m}^3/\text{h)}$$

$$(2) \text{ Flow rate (W/K)} = \varnothing = \frac{P_{syst}}{(T_{id_{max}} - T_{e_{max}})} \text{ (W/K)}$$

2 - Heating

If the calculated temperature is less than the temperature wanted, the inside of the enclosure must be heated. The solution is to use heating resistors. They can maintain the temperature above the dew point and thus prevent any risk of condensation. To maintain a uniform temperature inside the enclosure and thus prevent hot spots, Schneider Electric proposes a heating resistor equipped with a fan.

3 - Homogenize

Objective: Prevent hot spots.
Solution: stirring fan.

Thermal management system

Spare parts



AIR-AIR EXCHANGERS

Reference	Exchanger Battery	Fan (Fan + Capacitor)	Frontal Cover RAL 7035	Thermostat	Mounting Kit (instruction + full seal + screws)
NSYCEA14E	NSYCUSP0030	NSYCUSP0042	NSYCUSP0076	-	NSYCUSP0111
NSYCEA36	NSYCUSP0031	NSYCUSP0044	NSYCUSP0077	NSYCUSP0100	NSYCUSP0112
NSYCEA50	NSYCUSP0032	NSYCUSP0044	NSYCUSP0077	NSYCUSP0100	NSYCUSP0112
NSYCEA80	NSYCUSP0033	NSYCUSP0138	NSYCUSP0078	NSYCUSP0100	NSYCUSP0113



AIR-WATER EXCHANGERS

Reference	Exchanger Battery	Fan (Fan + Capacitor)	Frontal Cover RAL 7035	Frontal Cover Stainless Steel
NSYCEW1K	NSYCUSP0034	NSYCUSP0043	NSYCUSP0079	-
NSYCEWX1K	NSYCUSP0034	NSYCUSP0043	-	NSYCUSP0094
NSYCEW1KUL	NSYCUSP0034	NSYCUSP0043	NSYCUSP0079	-
NSYCEWX1KUL	NSYCUSP0034	NSYCUSP0043	-	NSYCUSP0094
NSYCEW1K8	NSYCUSP0035	NSYCUSP0044	NSYCUSP0080	-
NSYCEWX1K8	NSYCUSP0035	NSYCUSP0044	-	NSYCUSP0095
NSYCEW1K8UL	NSYCUSP0035	NSYCUSP0044	NSYCUSP0080	-
NSYCEWX1K8UL	NSYCUSP0035	NSYCUSP0044	-	NSYCUSP0095
NSYCEW2K5	NSYCUSP0036	NSYCUSP0136	NSYCUSP0080	-
NSYCEWX2K5	NSYCUSP0036	NSYCUSP0136	-	NSYCUSP0095
NSYCEW2K5UL	NSYCUSP0036	NSYCUSP0136	NSYCUSP0080	-
NSYCEWX2K5UL	NSYCUSP0036	NSYCUSP0136	-	NSYCUSP0095
NSYCEW3K5	NSYCUSP0037	NSYCUSP0138	NSYCUSP0081	-
NSYCEWX3K5	NSYCUSP0037	NSYCUSP0138	-	NSYCUSP0096
NSYCEW3K5UL	NSYCUSP0037	NSYCUSP0138	NSYCUSP0081	-
NSYCEWX3K5UL	NSYCUSP0037	NSYCUSP0138	-	NSYCUSP0096
NSYCEW4K5	NSYCUSP0037	NSYCUSP0137	NSYCUSP0081	-
NSYCEWX4K5	NSYCUSP0037	NSYCUSP0137	-	NSYCUSP0096
NSYCEW4K5UL	NSYCUSP0037	NSYCUSP0137	NSYCUSP0081	-
NSYCEWX4K5UL	NSYCUSP0037	NSYCUSP0137	-	NSYCUSP0096
NSYCEW6K	NSYCUSP0038	NSYCUSP0137	NSYCUSP0082	-
NSYCEWX6K	NSYCUSP0038	NSYCUSP0137	-	NSYCUSP0097
NSYCEW6KUL	NSYCUSP0038	NSYCUSP0137	NSYCUSP0082	-
NSYCEWX6KUL	NSYCUSP0038	NSYCUSP0137	-	NSYCUSP0097
NSYCEW6K2P4	NSYCUSP0038	NSYCUSP0137	NSYCUSP0082	-
NSYCEWX6K2P4	NSYCUSP0038	NSYCUSP0137	-	NSYCUSP0097
NSYCEW10K	NSYCUSP0039	NSYCUSP0137	NSYCUSP0083	-
NSYCEWX10K	NSYCUSP0039	NSYCUSP0137	-	NSYCUSP0098
NSYCEW10K2P4	NSYCUSP0039	NSYCUSP0137	NSYCUSP0083	-
NSYCEWX10K2P4	NSYCUSP0039	NSYCUSP0137	-	NSYCUSP0098
NSYCEW15K	NSYCUSP0040	NSYCUSP0137	NSYCUSP0083	-
NSYCEWX15K	NSYCUSP0040	NSYCUSP0137	-	NSYCUSP0098
NSYCEW15K2P4	NSYCUSP0040	NSYCUSP0137	NSYCUSP0083	-
NSYCEWX15K2P4	NSYCUSP0040	NSYCUSP0137	-	NSYCUSP0098
NSYCEW2K5R	NSYCUSP0041	NSYCUSP0053	NSYCUSP0084	-

Thermal management system

Spare parts

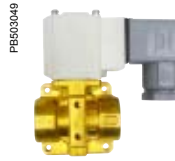

AIR-WATER EXCHANGERS

Reference	Thermostat	Transformer	Solenoid Valve	Mounting Kit (instruction + full seal + screws)
NSYCEW1K	NSYCUSP0100	-	NSYCUSP0108	NSYCUSP0114
NSYCEWX1K	NSYCUSP0100	-	NSYCUSP0108	NSYCUSP0114
NSYCEW1KUL	NSYCUSP0175	-	NSYCUSP0176	NSYCUSP0114
NSYCEWX1KUL	NSYCUSP0175	-	NSYCUSP0176	NSYCUSP0114
NSYCEW1K8	NSYCUSP0100	-	NSYCUSP0109	NSYCUSP0124
NSYCEWX1K8	NSYCUSP0100	-	NSYCUSP0109	NSYCUSP0124
NSYCEW1K8UL	NSYCUSP0175	-	NSYCUSP0176	NSYCUSP0124
NSYCEWX1K8UL	NSYCUSP0175	-	NSYCUSP0176	NSYCUSP0124
NSYCEW2K5	NSYCUSP0100	-	NSYCUSP0109	NSYCUSP0124
NSYCEWX2K5	NSYCUSP0100	-	NSYCUSP0109	NSYCUSP0124
NSYCEW2K5UL	NSYCUSP0175	-	NSYCUSP0176	NSYCUSP0124
NSYCEWX2K5UL	NSYCUSP0175	-	NSYCUSP0176	NSYCUSP0124
NSYCEW3K5	NSYCUSP0100	-	NSYCUSP0109	NSYCUSP0115
NSYCEWX3K5	NSYCUSP0100	-	NSYCUSP0109	NSYCUSP0115
NSYCEW3K5UL	NSYCUSP0175	-	NSYCUSP0176	NSYCUSP0115
NSYCEWX3K5UL	NSYCUSP0175	-	NSYCUSP0176	NSYCUSP0115
NSYCEW4K5	NSYCUSP0100	-	NSYCUSP0109	NSYCUSP0115
NSYCEWX4K5	NSYCUSP0100	-	NSYCUSP0109	NSYCUSP0115
NSYCEW4K5UL	NSYCUSP0175	-	NSYCUSP0176	NSYCUSP0115
NSYCEWX4K5UL	NSYCUSP0175	-	NSYCUSP0176	NSYCUSP0115
NSYCEW6K	NSYCUSP0100	-	NSYCUSP0109	NSYCUSP0125
NSYCEWX6K	NSYCUSP0100	-	NSYCUSP0109	NSYCUSP0125
NSYCEW6KUL	NSYCUSP0175	-	NSYCUSP0176	NSYCUSP0125
NSYCEWX6KUL	NSYCUSP0175	-	NSYCUSP0176	NSYCUSP0125
NSYCEW6K2P4	NSYCUSP0100	NSYCUSP0107	NSYCUSP0109	NSYCUSP0125
NSYCEWX6K2P4	NSYCUSP0100	NSYCUSP0107	NSYCUSP0109	NSYCUSP0125
NSYCEW10K	NSYCUSP0100	-	NSYCUSP0110	NSYCUSP0116
NSYCEWX10K	NSYCUSP0100	-	NSYCUSP0110	NSYCUSP0116
NSYCEW10K2P4	NSYCUSP0100	NSYCUSP0107	NSYCUSP0110	NSYCUSP0116
NSYCEWX10K2P4	NSYCUSP0100	NSYCUSP0107	NSYCUSP0110	NSYCUSP0116
NSYCEW15K	NSYCUSP0100	-	NSYCUSP0110	NSYCUSP0116
NSYCEWX15K	NSYCUSP0100	-	NSYCUSP0110	NSYCUSP0116
NSYCEW15K2P4	NSYCUSP0100	NSYCUSP0107	NSYCUSP0110	NSYCUSP0116
NSYCEWX15K2P4	NSYCUSP0100	NSYCUSP0107	NSYCUSP0110	NSYCUSP0116
NSYCEW2K5R	NSYCUSP0100	-	NSYCUSP0109	NSYCUSP0117

Thermal management system

Spare parts



COOLING UNITS: SIDE MOUNTING MODELS

Reference	Evaporator Battery	Evaporator Fan (fan + capacitor)	Condenser Battery	Condenser Fan (fan + capacitor)	Compressor Kit
NSYCU300H	NSYCUSP0001	NSYCUSP0042	NSYCUSP0013	NSYCUSP0042	NSYCUSP0054
NSYCU400	NSYCUSP0002	NSYCUSP0042	NSYCUSP0014	NSYCUSP0042	NSYCUSP0055
NSYCU400UL	NSYCUSP0002	NSYCUSP0042	NSYCUSP0014	NSYCUSP0042	NSYCUSP0055
NSYCUX400	NSYCUSP0002	NSYCUSP0042	NSYCUSP0014	NSYCUSP0042	NSYCUSP0055
NSYCU600	NSYCUSP0003	NSYCUSP0043	NSYCUSP0015	NSYCUSP0044	NSYCUSP0056
NSYCUX600	NSYCUSP0003	NSYCUSP0043	NSYCUSP0015	NSYCUSP0044	NSYCUSP0056
NSYCU600UL	NSYCUSP0003	NSYCUSP0043	NSYCUSP0015	NSYCUSP0044	NSYCUSP0056
NSYCU800	NSYCUSP0004	NSYCUSP0043	NSYCUSP0016	NSYCUSP0044	NSYCUSP0057
NSYCUX800	NSYCUSP0004	NSYCUSP0043	NSYCUSP0016	NSYCUSP0044	NSYCUSP0057
NSYCU800UL	NSYCUSP0004	NSYCUSP0043	NSYCUSP0016	NSYCUSP0044	NSYCUSP0057
NSYCUX800UL	NSYCUSP0004	NSYCUSP0043	NSYCUSP0016	NSYCUSP0044	NSYCUSP0057
NSYCU1K	NSYCUSP0004	NSYCUSP0043	NSYCUSP0017	NSYCUSP0044	NSYCUSP0057
NSYCUX1K	NSYCUSP0004	NSYCUSP0043	NSYCUSP0017	NSYCUSP0044	NSYCUSP0057
NSYCU1KUL	NSYCUSP0004	NSYCUSP0043	NSYCUSP0017	NSYCUSP0044	NSYCUSP0057
NSYCUX1KUL	NSYCUSP0004	NSYCUSP0043	NSYCUSP0017	NSYCUSP0044	NSYCUSP0057
NSYCU1K2P4	NSYCUSP0004	NSYCUSP0043	NSYCUSP0017	NSYCUSP0044	NSYCUSP0057
NSYCUX1K2P4	NSYCUSP0004	NSYCUSP0043	NSYCUSP0017	NSYCUSP0044	NSYCUSP0057
NSYCU1K2P4UL	NSYCUSP0004	NSYCUSP0043	NSYCUSP0017	NSYCUSP0044	NSYCUSP0057
NSYCUX1K2P4UL	NSYCUSP0004	NSYCUSP0043	NSYCUSP0017	NSYCUSP0044	NSYCUSP0057
NSYCU1K2	NSYCUSP0005	NSYCUSP0044	NSYCUSP0018	NSYCUSP0136	NSYCUSP0058
NSYCUX1K2	NSYCUSP0005	NSYCUSP0044	NSYCUSP0018	NSYCUSP0136	NSYCUSP0058
NSYCU1K2UL	NSYCUSP0005	NSYCUSP0044	NSYCUSP0018	NSYCUSP0136	NSYCUSP0058
NSYCUX1K2UL	NSYCUSP0005	NSYCUSP0044	NSYCUSP0018	NSYCUSP0136	NSYCUSP0058
NSYCU1K22P4	NSYCUSP0005	NSYCUSP0044	NSYCUSP0018	NSYCUSP0136	NSYCUSP0058
NSYCUX1K22P4	NSYCUSP0005	NSYCUSP0044	NSYCUSP0018	NSYCUSP0136	NSYCUSP0058
NSYCU1K6	NSYCUSP0006	NSYCUSP0044	NSYCUSP0019	NSYCUSP0138	NSYCUSP0059
NSYCUX1K6	NSYCUSP0006	NSYCUSP0044	NSYCUSP0019	NSYCUSP0138	NSYCUSP0059
NSYCU1K6UL	NSYCUSP0006	NSYCUSP0044	NSYCUSP0019	NSYCUSP0138	NSYCUSP0059
NSYCUX1K6UL	NSYCUSP0006	NSYCUSP0044	NSYCUSP0019	NSYCUSP0138	NSYCUSP0059
NSYCU1K62P4	NSYCUSP0006	NSYCUSP0044	NSYCUSP0019	NSYCUSP0138	NSYCUSP0059
NSYCUX1K62P4	NSYCUSP0006	NSYCUSP0044	NSYCUSP0019	NSYCUSP0138	NSYCUSP0059
NSYCU1K62P4UL	NSYCUSP0006	NSYCUSP0044	NSYCUSP0019	NSYCUSP0138	NSYCUSP0059
NSYCUX1K62P4UL	NSYCUSP0006	NSYCUSP0044	NSYCUSP0019	NSYCUSP0138	NSYCUSP0059
NSYCU2K	NSYCUSP0006	NSYCUSP0136	NSYCUSP0020	NSYCUSP0138	NSYCUSP0060
NSYCUX2K	NSYCUSP0006	NSYCUSP0136	NSYCUSP0020	NSYCUSP0138	NSYCUSP0060
NSYCU2KUL	NSYCUSP0006	NSYCUSP0136	NSYCUSP0020	NSYCUSP0138	NSYCUSP0139
NSYCUX2KUL	NSYCUSP0006	NSYCUSP0136	NSYCUSP0020	NSYCUSP0138	NSYCUSP0139
NSYCU2K3P4	NSYCUSP0006	NSYCUSP0136	NSYCUSP0020	NSYCUSP0138	NSYCUSP0061
NSYCUX2K3P4	NSYCUSP0006	NSYCUSP0136	NSYCUSP0020	NSYCUSP0138	NSYCUSP0061
NSYCU2K3P4UL	NSYCUSP0006	NSYCUSP0136	NSYCUSP0020	NSYCUSP0138	NSYCUSP0062
NSYCUX2K3P4UL	NSYCUSP0006	NSYCUSP0136	NSYCUSP0020	NSYCUSP0138	NSYCUSP0062
NSYCU3K3P4	NSYCUSP0007	NSYCUSP0137	NSYCUSP0021	NSYCUSP0137	NSYCUSP0062
NSYCUX3K3P4	NSYCUSP0007	NSYCUSP0137	NSYCUSP0021	NSYCUSP0137	NSYCUSP0062
NSYCU3K3P4UL	NSYCUSP0007	NSYCUSP0137	NSYCUSP0021	NSYCUSP0137	NSYCUSP0062
NSYCUX3K3P4UL	NSYCUSP0007	NSYCUSP0137	NSYCUSP0021	NSYCUSP0137	NSYCUSP0062
NSYCU4K3P4	NSYCUSP0007	NSYCUSP0137	NSYCUSP0022	NSYCUSP0137	NSYCUSP0063
NSYCUX4K3P4	NSYCUSP0007	NSYCUSP0137	NSYCUSP0022	NSYCUSP0137	NSYCUSP0063
NSYCU4K3P4UL	NSYCUSP0007	NSYCUSP0137	NSYCUSP0022	NSYCUSP0137	NSYCUSP0063
NSYCUX4K3P4UL	NSYCUSP0007	NSYCUSP0137	NSYCUSP0022	NSYCUSP0137	NSYCUSP0063
NSYCU6K3P4	-	-	-	-	-
NSYCU6K3P460	-	-	-	-	-
NSYCU8K3P4	-	-	-	-	-
NSYCU8K3P460	-	-	-	-	-
NSYCU10K3P4	-	-	-	-	-
NSYCU10K3P460	-	-	-	-	-
NSYCU15K3P4	-	-	-	-	-
NSYCU15K3P460	-	-	-	-	-

Thermal management system

Spare parts

PE503042



PE503042



PE503039



PE503046



COOLING UNITS & SIDE MOUNTING MODELS

Reference	Frontal Cover RAL 7035	Frontal Cover Stainless Steel	Thermostat	Transformer	Mounting Kit (instruction + full seal + screws)
NSYCU300H	NSYCUSP0066	-	NSYCUSP0099	-	NSYCUSP0118
NSYCU400	NSYCUSP0067	-	NSYCUSP0099	-	NSYCUSP0126
NSYCU400UL	NSYCUSP0067	-	NSYCUSP0144	-	NSYCUSP0126
NSYCUX400	-	NSYCUSP0085	NSYCUSP0099	-	NSYCUSP0126
NSYCU600	NSYCUSP0068	-	NSYCUSP0099	-	NSYCUSP0127
NSYCUX600	-	NSYCUSP0086	NSYCUSP0099	-	NSYCUSP0127
NSYCU600UL	NSYCUSP0068	-	NSYCUSP0144	-	NSYCUSP0127
NSYCUX600UL	-	NSYCUSP0086	NSYCUSP0144	-	NSYCUSP0127
NSYCU800	NSYCUSP0069	-	NSYCUSP0099	-	NSYCUSP0119
NSYCUX800	-	NSYCUSP0087	NSYCUSP0099	-	NSYCUSP0119
NSYCU800UL	NSYCUSP0069	-	NSYCUSP0144	-	NSYCUSP0119
NSYCUX800UL	-	NSYCUSP0087	NSYCUSP0144	-	NSYCUSP0119
NSYCU1K	NSYCUSP0069	-	NSYCUSP0099	-	NSYCUSP0119
NSYCUX1K	-	NSYCUSP0087	NSYCUSP0099	-	NSYCUSP0119
NSYCU1KUL	NSYCUSP0069	-	NSYCUSP0144	-	NSYCUSP0119
NSYCUX1KUL	-	NSYCUSP0087	NSYCUSP0144	-	NSYCUSP0119
NSYCU1K2P4	NSYCUSP0069	-	NSYCUSP0099	NSYCUSP0101	NSYCUSP0119
NSYCUX1K2P4	-	NSYCUSP0087	NSYCUSP0099	NSYCUSP0101	NSYCUSP0119
NSYCU1K2P4UL	NSYCUSP0069	-	NSYCUSP0144	NSYCUSP0173	NSYCUSP0119
NSYCUX1K2P4UL	-	NSYCUSP0087	NSYCUSP0144	NSYCUSP0173	NSYCUSP0119
NSYCU1K2	NSYCUSP0070	-	NSYCUSP0099	-	NSYCUSP0120
NSYCUX1K2	-	NSYCUSP0088	NSYCUSP0099	-	NSYCUSP0120
NSYCU1K2UL	NSYCUSP0070	-	NSYCUSP0144	-	NSYCUSP0120
NSYCUX1K2UL	-	NSYCUSP0088	NSYCUSP0144	-	NSYCUSP0120
NSYCU1K22P4	NSYCUSP0070	-	NSYCUSP0099	NSYCUSP0102	NSYCUSP0120
NSYCUX1K22P4	-	NSYCUSP0088	NSYCUSP0099	NSYCUSP0102	NSYCUSP0120
NSYCU1K6	NSYCUSP0070	-	NSYCUSP0099	-	NSYCUSP0120
NSYCUX1K6	-	NSYCUSP0088	NSYCUSP0099	-	NSYCUSP0120
NSYCU1K6UL	NSYCUSP0070	-	NSYCUSP0144	-	NSYCUSP0120
NSYCUX1K6UL	-	NSYCUSP0088	NSYCUSP0144	-	NSYCUSP0120
NSYCU1K62P4	NSYCUSP0070	-	NSYCUSP0099	NSYCUSP0103	NSYCUSP0120
NSYCUX1K62P4	-	NSYCUSP0088	NSYCUSP0099	NSYCUSP0103	NSYCUSP0120
NSYCU1K62P4UL	NSYCUSP0070	-	NSYCUSP0144	NSYCUSP0174	NSYCUSP0120
NSYCUX1K62P4UL	-	NSYCUSP0088	NSYCUSP0144	NSYCUSP0174	NSYCUSP0120
NSYCU2K	NSYCUSP0070	-	NSYCUSP0099	-	NSYCUSP0120
NSYCUX2K	-	NSYCUSP0088	NSYCUSP0099	-	NSYCUSP0120
NSYCU2KUL	NSYCUSP0070	-	NSYCUSP0144	-	NSYCUSP0120
NSYCUX2KUL	-	NSYCUSP0088	NSYCUSP0144	-	NSYCUSP0120
NSYCU2K3P4	NSYCUSP0070	-	NSYCUSP0099	NSYCUSP0104	NSYCUSP0120
NSYCUX2K3P4	-	NSYCUSP0088	NSYCUSP0099	NSYCUSP0104	NSYCUSP0120
NSYCU2K3P4UL	NSYCUSP0070	-	NSYCUSP0144	NSYCUSP0147	NSYCUSP0120
NSYCUX2K3P4UL	-	NSYCUSP0088	NSYCUSP0144	NSYCUSP0147	NSYCUSP0120
NSYCU3K3P4	NSYCUSP0071	-	NSYCUSP0099	NSYCUSP0105	NSYCUSP0128
NSYCUX3K3P4	-	NSYCUSP0089	NSYCUSP0099	NSYCUSP0105	NSYCUSP0128
NSYCU3K3P4UL	NSYCUSP0071	-	NSYCUSP0144	NSYCUSP0148	NSYCUSP0128
NSYCUX3K3P4UL	-	NSYCUSP0089	NSYCUSP0144	NSYCUSP0148	NSYCUSP0128
NSYCU4K3P4	NSYCUSP0071	-	NSYCUSP0099	NSYCUSP0105	NSYCUSP0128
NSYCUX4K3P4	-	NSYCUSP0089	NSYCUSP0099	NSYCUSP0105	NSYCUSP0128
NSYCU4K3P4UL	NSYCUSP0071	-	NSYCUSP0144	NSYCUSP0148	NSYCUSP0128
NSYCUX4K3P4UL	-	NSYCUSP0089	NSYCUSP0144	NSYCUSP0148	NSYCUSP0128
NSYCU6K3P4	-	-	NSYCUSP0099	-	-
NSYCU6K3P460	-	-	NSYCUSP0099	-	-
NSYCU8K3P4	-	-	NSYCUSP0099	-	-
NSYCU8K3P460	-	-	NSYCUSP0099	-	-
NSYCU10K3P4	-	-	NSYCUSP0099	-	-
NSYCU10K3P460	-	-	NSYCUSP0099	-	-
NSYCU15K3P4	-	-	NSYCUSP0099	-	-
NSYCU15K3P460	-	-	NSYCUSP0099	-	-



Thermal management system

Spare parts

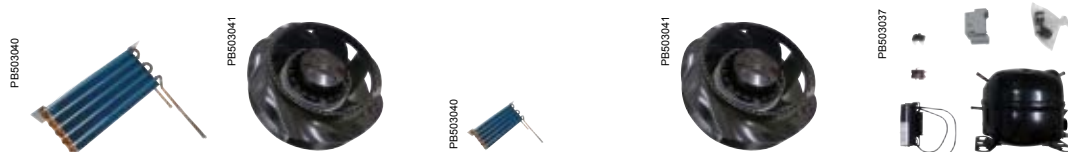

COOLING UNITS: ROOF MOUNT

Reference	Evaporator battery	Evaporator fan (fan + capacitor)	Condenser battery	Condenser fan (fan + capacitor)	Compressor kit
NSYCU400R	NSYCUSP0008	NSYCUSP0047	NSYCUSP0023	NSYCUSP0043	NSYCUSP0064
NSYCUX400R	NSYCUSP0008	NSYCUSP0047	NSYCUSP0023	NSYCUSP0043	NSYCUSP0064
NSYCU400RUL	NSYCUSP0008	NSYCUSP0047	NSYCUSP0023	NSYCUSP0043	NSYCUSP0172
NSYCU800R	NSYCUSP0009	NSYCUSP0044	NSYCUSP0024	NSYCUSP0136	NSYCUSP0065
NSYCUX800R	NSYCUSP0009	NSYCUSP0044	NSYCUSP0024	NSYCUSP0136	NSYCUSP0065
NSYCU800RUL	NSYCUSP0009	NSYCUSP0044	NSYCUSP0024	NSYCUSP0136	NSYCUSP0065
NSYCU1K2R	NSYCUSP0010	NSYCUSP0044	NSYCUSP0025	NSYCUSP0049	NSYCUSP0065
NSYCUX1K2R	NSYCUSP0010	NSYCUSP0044	NSYCUSP0025	NSYCUSP0049	NSYCUSP0065
NSYCU1K2RUL	NSYCUSP0010	NSYCUSP0044	NSYCUSP0025	NSYCUSP0049	NSYCUSP0065
NSYCU1K5R	NSYCUSP0010	NSYCUSP0136	NSYCUSP0026	NSYCUSP0049	NSYCUSP0059
NSYCUX1K5R	NSYCUSP0010	NSYCUSP0136	NSYCUSP0026	NSYCUSP0049	NSYCUSP0059
NSYCU1K5RUL	NSYCUSP0010	NSYCUSP0136	NSYCUSP0026	NSYCUSP0049	NSYCUSP0059
NSYCU2K3P4R	NSYCUSP0011	NSYCUSP0136	NSYCUSP0027	NSYCUSP0049	NSYCUSP0061
NSYCUX2K3P4R	NSYCUSP0011	NSYCUSP0136	NSYCUSP0027	NSYCUSP0049	NSYCUSP0061
NSYCU2K3P4RUL	NSYCUSP0011	NSYCUSP0136	NSYCUSP0027	NSYCUSP0049	NSYCUSP0062
NSYCU2KR	NSYCUSP0011	NSYCUSP0136	NSYCUSP0027	NSYCUSP0049	NSYCUSP0060
NSYCUX2KR	NSYCUSP0011	NSYCUSP0136	NSYCUSP0027	NSYCUSP0049	NSYCUSP0060
NSYCU3K3P4R	NSYCUSP0012	NSYCUSP0136	NSYCUSP0028	NSYCUSP0051	NSYCUSP0062
NSYCUX3K3P4R	NSYCUSP0012	NSYCUSP0136	NSYCUSP0028	NSYCUSP0051	NSYCUSP0062
NSYCU3K3P4RUL	NSYCUSP0012	NSYCUSP0136	NSYCUSP0028	NSYCUSP0051	NSYCUSP0062
NSYCU4K3P4R	NSYCUSP0012	NSYCUSP0137	NSYCUSP0029	NSYCUSP0051	NSYCUSP0063
NSYCUX4K3P4R	NSYCUSP0012	NSYCUSP0137	NSYCUSP0029	NSYCUSP0051	NSYCUSP0063
NSYCU4K3P4RUL	NSYCUSP0012	NSYCUSP0137	NSYCUSP0029	NSYCUSP0051	NSYCUSP0063

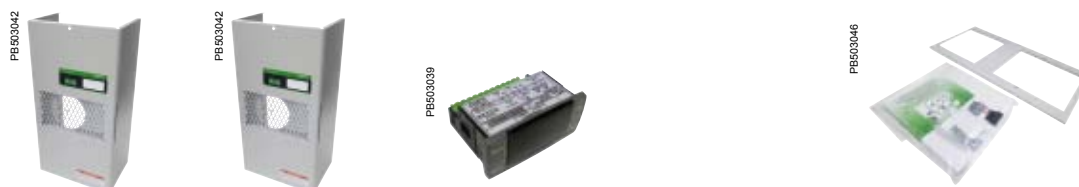

Reference	Frontal cover RAL 7035	Frontal cover stainless steel	Thermostat	Transformer	Mounting Kit (instruction + full seal + screws)
NSYCU400R	NSYCUSP0072	-	NSYCUSP0099	-	NSYCUSP0121
NSYCUX400R	-	NSYCUSP0090	NSYCUSP0099	-	NSYCUSP0121
NSYCU400RUL	NSYCUSP0072	-	NSYCUSP0144	-	NSYCUSP0121
NSYCU800R	NSYCUSP0073	-	NSYCUSP0099	-	NSYCUSP0122
NSYCUX800R	-	NSYCUSP0091	NSYCUSP0099	-	NSYCUSP0122
NSYCU800RUL	NSYCUSP0073	-	NSYCUSP0144	-	NSYCUSP0122
NSYCU1K2R	NSYCUSP0074	-	NSYCUSP0099	-	NSYCUSP0129
NSYCUX1K2R	-	NSYCUSP0092	NSYCUSP0099	-	NSYCUSP0129
NSYCU1K2RUL	NSYCUSP0074	-	NSYCUSP0144	-	NSYCUSP0129
NSYCU1K5R	NSYCUSP0074	-	NSYCUSP0099	-	NSYCUSP0129
NSYCUX1K5R	-	NSYCUSP0092	NSYCUSP0099	-	NSYCUSP0129
NSYCU1K5RUL	NSYCUSP0074	-	NSYCUSP0144	-	NSYCUSP0129
NSYCU2K3P4R	NSYCUSP0074	-	NSYCUSP0099	NSYCUSP0104	NSYCUSP0129
NSYCUX2K3P4R	-	NSYCUSP0092	NSYCUSP0099	NSYCUSP0104	NSYCUSP0129
NSYCU2K3P4RUL	NSYCUSP0074	-	NSYCUSP0144	NSYCUSP0147	NSYCUSP0129
NSYCU2KR	NSYCUSP0074	-	NSYCUSP0099	-	NSYCUSP0129
NSYCUX2KR	-	NSYCUSP0092	NSYCUSP0099	-	NSYCUSP0129
NSYCU3K3P4R	NSYCUSP0075	-	NSYCUSP0099	NSYCUSP0106	NSYCUSP0123
NSYCUX3K3P4R	-	NSYCUSP0093	NSYCUSP0099	NSYCUSP0106	NSYCUSP0123
NSYCU3K3P4RUL	NSYCUSP0075	-	NSYCUSP0144	NSYCUSP0148	NSYCUSP0123
NSYCU4K3P4R	NSYCUSP0075	-	NSYCUSP0099	NSYCUSP0105	NSYCUSP0123
NSYCUX4K3P4R	-	NSYCUSP0093	NSYCUSP0099	NSYCUSP0105	NSYCUSP0123
NSYCU4K3P4RUL	NSYCUSP0075	-	NSYCUSP0144	NSYCUSP0148	NSYCUSP0123

Thermal management system

Spare parts

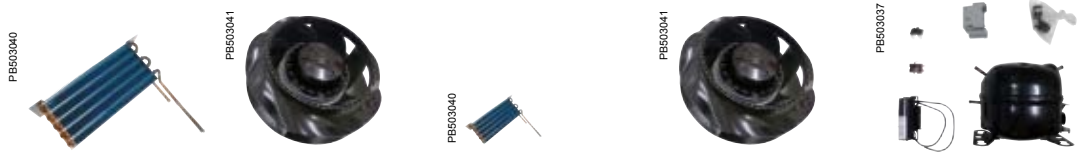

COOLING UNITS HEAVY DUTY

Reference	Evaporator battery	Evaporator fan (fan + capacitor)	Condenser battery	Condenser fan (fan + capacitor)	Compressor kit
NSYCUHD400	NSYCUSP0002	NSYCUSP0042	NSYCUSP0158	NSYCUSP0042	NSYCUSP0055
NSYCUHD600	NSYCUSP0003	NSYCUSP0043	NSYCUSP0159	NSYCUSP0044	NSYCUSP0056
NSYCUHD800	NSYCUSP0004	NSYCUSP0043	NSYCUSP0160	NSYCUSP0044	NSYCUSP0057
NSYCUHD1K	NSYCUSP0004	NSYCUSP0043	NSYCUSP0161	NSYCUSP0044	NSYCUSP0057
NSYCUHD1K2P4	NSYCUSP0004	NSYCUSP0043	NSYCUSP0161	NSYCUSP0044	NSYCUSP0057
NSYCUHD1K6	NSYCUSP0006	NSYCUSP0044	NSYCUSP0162	NSYCUSP0138	NSYCUSP0059
NSYCUHD1K62P4	NSYCUSP0006	NSYCUSP0044	NSYCUSP0162	NSYCUSP0138	NSYCUSP0059
NSYCUHD2K3P4	NSYCUSP0006	NSYCUSP0136	NSYCUSP0163	NSYCUSP0138	NSYCUSP0061
NSYCUHD3K3P4	NSYCUSP0007	NSYCUSP0137	NSYCUSP0164	NSYCUSP0137	NSYCUSP0062
NSYCUHD4K3P4	NSYCUSP0007	NSYCUSP0137	NSYCUSP0165	NSYCUSP0137	NSYCUSP0063



Reference	Frontal cover RAL 7035	Thermostat	Transformer	Mounting Kit (instruction + full seal + screws)
NSYCUHD400	NSYCUSP0167	NSYCUSP0100	-	NSYCUSP0153
NSYCUHD600	NSYCUSP0168	NSYCUSP0100	-	NSYCUSP0154
NSYCUHD800	NSYCUSP0169	NSYCUSP0100	-	NSYCUSP0155
NSYCUHD1K	NSYCUSP0169	NSYCUSP0100	-	NSYCUSP0155
NSYCUHD1K2P4	NSYCUSP0169	NSYCUSP0100	NSYCUSP0101	NSYCUSP0155
NSYCUHD1K6	NSYCUSP0170	NSYCUSP0100	-	NSYCUSP0156
NSYCUHD1K62P4	NSYCUSP0170	NSYCUSP0100	NSYCUSP0103	NSYCUSP0156
NSYCUHD2K3P4	NSYCUSP0170	NSYCUSP0100	NSYCUSP0104	NSYCUSP0156
NSYCUHD3K3P4	NSYCUSP0171	NSYCUSP0100	NSYCUSP0105	NSYCUSP0157
NSYCUHD4K3P4	NSYCUSP0171	NSYCUSP0100	NSYCUSP0105	NSYCUSP0157

Thermal management system

Spare parts



COOLING UNITS SLIM

Reference	Evaporator battery	Evaporator fan (fan + capacitor)	Condenser battery	Condenser fan (fan + capacitor)	Compressor kit
NSYCUS1K1UL	NSYCUSP0130	NSYCUSP0136	NSYCUSP0133	NSYCUSP0136	NSYCUSP0059
NSYCUSX1K1UL	NSYCUSP0130	NSYCUSP0136	NSYCUSP0133	NSYCUSP0136	NSYCUSP0059
NSYCUS1K12P4UL	NSYCUSP0130	NSYCUSP0136	NSYCUSP0133	NSYCUSP0136	NSYCUSP0059
NSYCUSX1K12P4UL	NSYCUSP0130	NSYCUSP0136	NSYCUSP0133	NSYCUSP0136	NSYCUSP0059
NSYCUS1K5UL	NSYCUSP0131	NSYCUSP0136	NSYCUSP0133	NSYCUSP0138	NSYCUSP0059
NSYCUSX1K5UL	NSYCUSP0131	NSYCUSP0136	NSYCUSP0133	NSYCUSP0138	NSYCUSP0059
NSYCUS1K52P4UL	NSYCUSP0131	NSYCUSP0136	NSYCUSP0133	NSYCUSP0138	NSYCUSP0059
NSYCUSX1K52P4UL	NSYCUSP0131	NSYCUSP0136	NSYCUSP0133	NSYCUSP0138	NSYCUSP0059
NSYCUS2KUL	NSYCUSP0131	NSYCUSP0136	NSYCUSP0134	NSYCUSP0138	NSYCUSP0139
NSYCUSX2KUL	NSYCUSP0131	NSYCUSP0136	NSYCUSP0134	NSYCUSP0138	NSYCUSP0139
NSYCUS2K3P4UL	NSYCUSP0131	NSYCUSP0136	NSYCUSP0134	NSYCUSP0138	NSYCUSP0062
NSYCUSX2K3P4UL	NSYCUSP0131	NSYCUSP0136	NSYCUSP0134	NSYCUSP0138	NSYCUSP0062
NSYCUS2K5UL	NSYCUSP0132	NSYCUSP0137	NSYCUSP0135	NSYCUSP0137	NSYCUSP0140
NSYCUSX2K5UL	NSYCUSP0132	NSYCUSP0137	NSYCUSP0135	NSYCUSP0137	NSYCUSP0140
NSYCUS2K53P4UL	NSYCUSP0132	NSYCUSP0137	NSYCUSP0135	NSYCUSP0137	NSYCUSP0062
NSYCUSX2K53P4UL	NSYCUSP0132	NSYCUSP0137	NSYCUSP0135	NSYCUSP0137	NSYCUSP0062
NSYCUS3K2UL	NSYCUSP0132	NSYCUSP0137	NSYCUSP0135	NSYCUSP0137	NSYCUSP0141
NSYCUSX3K2UL	NSYCUSP0132	NSYCUSP0137	NSYCUSP0135	NSYCUSP0137	NSYCUSP0141
NSYCUS3K23P4UL	NSYCUSP0132	NSYCUSP0137	NSYCUSP0135	NSYCUSP0137	NSYCUSP0063
NSYCUSX3K23P4UL	NSYCUSP0132	NSYCUSP0137	NSYCUSP0135	NSYCUSP0137	NSYCUSP0063

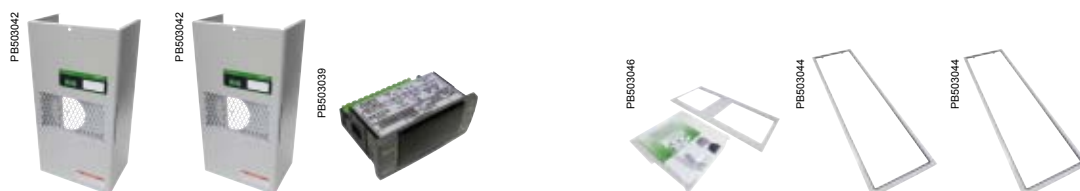

Reference	Frontal cover RAL 7035	Frontal cover stainless steel	Thermostat	Transformer	Mounting kit (instruction + full seal + screws)	Metal frame kit (frame + seal + screws)	Metal frame kit stainless steel (frame + seal + screws)
NSYCUS1K1UL	NSYCUSP0142	-	NSYCUSP0144	-	NSYCUSP0149	NSYCUSP0152	NSYCUSP0166
NSYCUSX1K1UL	-	NSYCUSP0150	NSYCUSP0144	-	NSYCUSP0149	NSYCUSP0152	NSYCUSP0166
NSYCUS1K12P4UL	NSYCUSP0142	-	NSYCUSP0144	NSYCUSP0145	NSYCUSP0149	NSYCUSP0152	NSYCUSP0166
NSYCUSX1K12P4UL	-	NSYCUSP0150	NSYCUSP0144	NSYCUSP0145	NSYCUSP0149	NSYCUSP0152	NSYCUSP0166
NSYCUS1K5UL	NSYCUSP0142	-	NSYCUSP0144	-	NSYCUSP0149	NSYCUSP0152	NSYCUSP0166
NSYCUSX1K5UL	-	NSYCUSP0150	NSYCUSP0144	-	NSYCUSP0149	NSYCUSP0152	NSYCUSP0166
NSYCUS1K52P4UL	NSYCUSP0142	-	NSYCUSP0144	NSYCUSP0146	NSYCUSP0149	NSYCUSP0152	NSYCUSP0166
NSYCUSX1K52P4UL	-	NSYCUSP0150	NSYCUSP0144	NSYCUSP0146	NSYCUSP0149	NSYCUSP0152	NSYCUSP0166
NSYCUS2KUL	NSYCUSP0142	-	NSYCUSP0144	-	NSYCUSP0149	NSYCUSP0152	NSYCUSP0166
NSYCUSX2KUL	-	NSYCUSP0150	NSYCUSP0144	-	NSYCUSP0149	NSYCUSP0152	NSYCUSP0166
NSYCUS2K3P4UL	NSYCUSP0142	-	NSYCUSP0144	NSYCUSP0147	NSYCUSP0149	NSYCUSP0152	NSYCUSP0166
NSYCUSX2K3P4UL	-	NSYCUSP0150	NSYCUSP0144	NSYCUSP0147	NSYCUSP0149	NSYCUSP0152	NSYCUSP0166
NSYCUS2K5UL	NSYCUSP0143	-	NSYCUSP0144	-	NSYCUSP0149	NSYCUSP0152	NSYCUSP0166
NSYCUSX2K5UL	-	NSYCUSP0151	NSYCUSP0144	-	NSYCUSP0149	NSYCUSP0152	NSYCUSP0166
NSYCUS2K53P4UL	NSYCUSP0143	-	NSYCUSP0144	NSYCUSP0148	NSYCUSP0149	NSYCUSP0152	NSYCUSP0166
NSYCUSX2K53P4UL	-	NSYCUSP0151	NSYCUSP0144	NSYCUSP0148	NSYCUSP0149	NSYCUSP0152	NSYCUSP0166
NSYCUS3K2UL	NSYCUSP0143	-	NSYCUSP0144	-	NSYCUSP0149	NSYCUSP0152	NSYCUSP0166
NSYCUSX3K2UL	-	NSYCUSP0151	NSYCUSP0144	-	NSYCUSP0149	NSYCUSP0152	NSYCUSP0166
NSYCUS3K23P4UL	NSYCUSP0143	-	NSYCUSP0144	NSYCUSP0148	NSYCUSP0149	NSYCUSP0152	NSYCUSP0166
NSYCUSX3K23P4UL	-	NSYCUSP0151	NSYCUSP0144	NSYCUSP0148	NSYCUSP0149	NSYCUSP0152	NSYCUSP0166



Schneider Electric Industries SAS

35, rue Joseph Monier
CS 30323
92506 Rueil Malmaison Cedex
France

RCS Nanterre 954 503 439
Capital social 896 313 776 €
www.schneider-electric.com

02-2017
UE16MK02EN

© 2017 - Schneider Electric - All rights reserved.
All trademarks are owned by Schneider Electric Industries SAS or its affiliated companies.

This document has been
printed on ecological paper. 