

Aluminum Electrolytic Capacitors

SMD (Chip), Very Low Z, High Vibration Capability

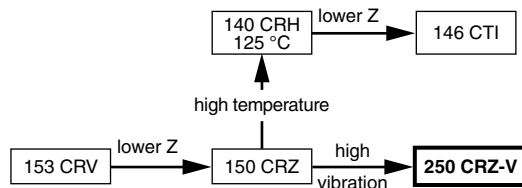

Fig. 1

QUICK REFERENCE DATA	
DESCRIPTION	VALUE
Nominal case sizes (L x W x H in mm)	16 x 16 x 16 to 18 x 18 x 21
Rated capacitance range, C_R	220 μ F to 10 000 μ F
Tolerance on C_R	\pm 20 %
Rated voltage range, U_R	6.3 V to 100 V
Category temperature range	
6.3 V to 63 V:	-55 °C to +105 °C
80 V to 100 V:	-40 °C to +105 °C
Endurance test at 105 °C	3000 h to 8000 h
Useful life at 105 °C	5000 h to 10 000 h
Useful life at 40 °C; 1.8 x I_R applied	250 000 h to 500 000 h
Shelf life at 0 V, 105 °C	1000 h
Based on sectional specification	IEC 60384-18 / CECC 32300
Climatic category IEC 60068	
6.3 V to 63 V:	55 / 105 / 56
80 V to 100 V:	40 / 105 / 56

FEATURES

- Extended useful life: up to 10 000 h at 105 °C
- Polarized aluminum electrolytic capacitors, non-solid electrolyte, self healing
- SMD-version with base plate, lead (Pb)-free reflow solderable
- Very low impedance, very high ripple current
- Charge and discharge proof, no peak current limitation
- Parts for advanced high temperature reflow soldering according to JEDEC® J-STD-020
- Vibration proof, 6-pin version up to 30 g
- AEC-Q200 qualified
- High reliability
- Low ESR
- Material categorization: for definitions of compliance please see www.vishay.com/doc?99912

AUTOMOTIVE GRADE



RoHS COMPLIANT

APPLICATIONS

- SMD technology, for high temperature reflow soldering
- Industrial and professional applications
- Automotive, general industrial, telecom
- Smoothing, filtering, buffering

MARKING

- Rated capacitance (in μ F)
- Rated voltage (in V)
- Date code, in accordance with IEC 60062
- Black mark or “-” sign indicating the cathode (the anode is identified by beveled edges)
- Code indicating group number (Z)

PACKAGING

Supplied in blister tape on reel

SELECTION CHART FOR C_R , U_R , AND RELEVANT NOMINAL CASE SIZES (L x W x H in mm)									
C_R (μF)	U_R (V)								
	6.3	10	16	25	35	50	63	80	100
220	→	→	→	→	→	→	→	→	16 x 16 x 16
330	→	→	→	→	→	→	16 x 16 x 16	16 x 16 x 16	16 x 16 x 21 18 x 18 x 16
470	→	→	→	→	→	→	16 x 16 x 21 18 x 18 x 16	16 x 16 x 21 18 x 18 x 16	18 x 18 x 21
680	→	→	→	→	→	16 x 16 x 16	18 x 18 x 21	18 x 18 x 21	-
1000	→	→	→	→	16 x 16 x 16	16 x 16 x 21 18 x 18 x 16	-	-	-
1500	→	→	→	16 x 16 x 16	16 x 16 x 21 18 x 18 x 16	18 x 18 x 21	-	-	-
2200	→	→	16 x 16 x 16	16 x 16 x 21 18 x 18 x 16	18 x 18 x 21	-	-	-	-
3300	→	16 x 16 x 16	16 x 16 x 21 18 x 18 x 16	18 x 18 x 21	-	-	-	-	-
4700	16 x 16 x 16	16 x 16 x 21 18 x 18 x 16	18 x 18 x 21	-	-	-	-	-	-
6800	16 x 16 x 21 18 x 18 x 16	18 x 18 x 21	-	-	-	-	-	-	-
10 000	18 x 18 x 21	-	-	-	-	-	-	-	-

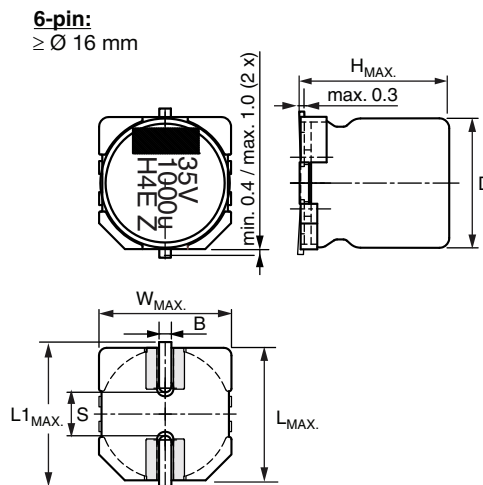

Fig. 2 - Dimensional outline

Table 1

DIMENSIONS in millimeters AND MASS									
NOMINAL CASE SIZE L x W x H	CASE CODE	L_{MAX}	W_{MAX}	H_{MAX}	$\varnothing D$	B_{MAX}	S	$L1_{MAX}$	MASS (g)
16 x 16 x 16	1616	16.6	16.6	17.5	16.0	1.3	6.5	18.6	≈ 5.5
16 x 16 x 21	1621	16.6	16.6	22.0	16.0	1.3	6.5	18.6	≈ 6.0
18 x 18 x 16	1816	19.0	19.0	17.5	18.0	1.3	6.5	21.0	≈ 8.0
18 x 18 x 21	1821	19.0	19.0	22.0	18.0	1.3	6.5	21.0	≈ 8.3

Table 2

TAPE AND REEL DIMENSIONS in millimeters, PACKAGING QUANTITIES						
NOMINAL CASE SIZE L x W x H	CASE CODE	PITCH P ₁	TAPE WIDTH W	TAPE THICKNESS T ₂	REEL DIAMETER	PACKAGING QUANTITY PER REEL
16 x 16 x 16	1616	28	44	18.9	380	150
16 x 16 x 21	1621	28	44	23.4	380	100
18 x 18 x 16	1816	32	44	18.9	380	125
18 x 18 x 21	1821	32	44	23.4	380	100

Note

- Detailed tape dimensions see section “PACKAGING”

MOUNTING

The capacitors are designed for automatic placement on to printed-circuit boards.

Optimum dimensions of soldering pads depend amongst others on soldering method, mounting accuracy, print layout and / or adjacent components. For recommended soldering pad dimensions, refer to Fig. 3 and Table 3.

SOLDERING

Soldering conditions are defined by the curve, temperature versus time, where the temperature is that measured on the component during processing.

For maximum conditions refer to Fig. 4.

Any temperature versus time curve which does not exceed the specified maximum curves may be applied.

As a general principle, temperature and duration shall be the **minimum** necessary required to ensure good soldering connections. However, the specified maximum curves should never be exceeded.

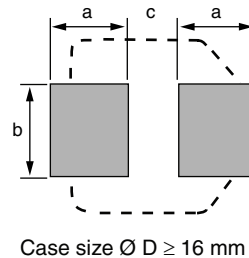

Fig. 3 - Recommended soldering pad dimensions

Table 3

RECOMMENDED SOLDERING PAD DIMENSIONS in millimeters			
CASE CODE	a	b	c
1616	7.8	9.6	4.7
1621	7.8	9.6	4.7
1816	8.8	9.6	4.7
1821	8.8	9.6	4.7

**ADVANCED SOLDERING PROFILE FOR LEAD (Pb)-FREE REFLOW PROCESS
ACCORDING TO JEDEC J-STD-020**

Fig. 4 - Maximum temperature load during reflow soldering

Table 4

REFLOW SOLDERING CONDITIONS for MAL225099xxxE3	
PROFILE FEATURES	CASE CODE 1616 TO 1821
Maximum time from 25 °C to T_{Peak}	300 s
Maximum ramp-up rate to 150 °C	3 K/s
Maximum time from 150 °C to 200 °C (t_1)	150 s
Maximum time from 190 °C to 200 °C (t_2)	110 s
Ramp up rate from 200 °C to T_{Peak}	0.5 K/s to 3 K/s
Maximum time above $T_{Liquidus}$ (217 °C) (t_3)	90 s
Maximum time above 230 °C (t_4)	60 s
Peak temperature T_{Peak}	245 °C
Maximum time above T_{Peak} minus 5 °C	30 s
Ramp-down rate from $T_{Liquidus}$	3 K/s to 6 K/s

Notes

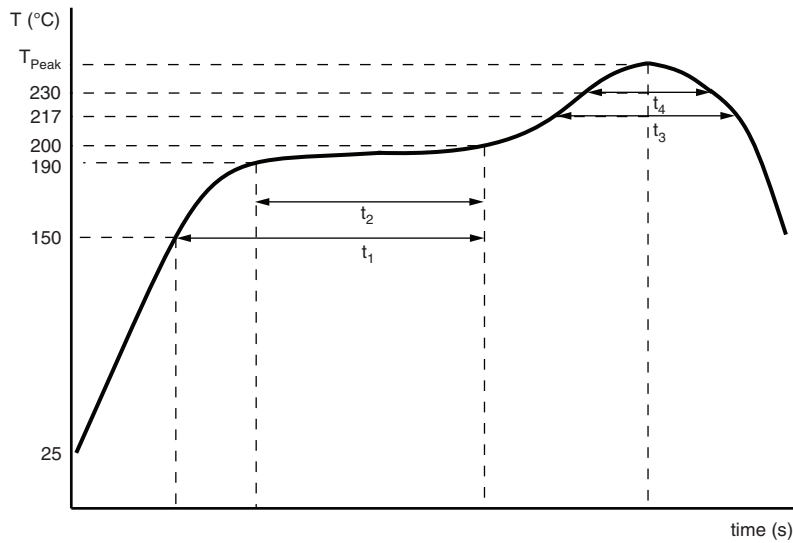
- Temperature measuring point on top of the case and on terminals
- Max. 2 runs with pause of min. 30 min in between



ELECTRICAL DATA	
SYMBOL	DESCRIPTION
C_R	Rated capacitance at 100 Hz, tolerance $\pm 20\%$
I_R	Rated RMS ripple current at 100 kHz, 105 °C
I_{L2}	Max. leakage current after 2 min at U_R
$\tan \delta$	Max. dissipation factor at 100 Hz
Z	Max. impedance at 100 kHz

Note

- Unless otherwise specified, all electrical values in Table 5 apply at $T_{amb} = 20\text{ °C}$, $P = 86\text{ kPa}$ to 106 kPa , $RH = 45\%$ to 75%

Table 5

ELECTRICAL DATA AND ORDERING INFORMATION									
U_R (V)	C_R (μF)	NOMINAL CASE SIZE L x W x H (mm)	I_R 105 °C 100 kHz (mA)	I_L 2 min (μA)	$\tan \delta$ 100 Hz	Z 100 kHz 20 °C (Ω)	Z 100 kHz -40 °C (Ω)	LIFE CODE ⁽¹⁾	ORDERING CODE MAL2250...
6.3	4700	16 x 16 x 16	1350	296	0.28	0.050	0.40	L2	99313E3
	6800	16 x 16 x 21	1666	428	0.30	0.035	0.28	L2	99314E3
	6800	18 x 18 x 16	1400	428	0.32	0.050	0.40	L2	99315E3
	10 000	18 x 18 x 21	1756	630	0.34	0.035	0.28	L2	99316E3
10	3300	16 x 16 x 16	1350	330	0.24	0.050	0.40	L2	99415E3
	4700	16 x 16 x 21	1666	470	0.26	0.035	0.28	L2	99416E3
	4700	18 x 18 x 16	1400	470	0.26	0.050	0.40	L2	99417E3
	6800	18 x 18 x 21	1756	680	0.28	0.035	0.28	L2	99418E3
16	2200	16 x 16 x 16	1350	352	0.20	0.050	0.40	L2	99515E3
	3300	16 x 16 x 21	1666	528	0.22	0.035	0.28	L2	99516E3
	3300	18 x 18 x 16	1400	528	0.22	0.050	0.40	L2	99517E3
	4700	18 x 18 x 21	1756	752	0.26	0.035	0.28	L2	99518E3
25	1500	16 x 16 x 16	1350	375	0.16	0.050	0.40	L2	99615E3
	2200	16 x 16 x 21	1666	550	0.18	0.035	0.28	L2	99616E3
	2200	18 x 18 x 16	1400	550	0.18	0.050	0.40	L2	99617E3
	3300	18 x 18 x 21	1756	825	0.20	0.035	0.28	L2	99618E3
35	1000	16 x 16 x 16	1350	350	0.14	0.050	0.40	L2	99014E3
	1500	16 x 16 x 21	1666	525	0.14	0.035	0.28	L2	99015E3
	1500	18 x 18 x 16	1400	525	0.14	0.050	0.40	L2	99016E3
	2200	18 x 18 x 21	1756	770	0.16	0.035	0.28	L2	99017E3
50	680	16 x 16 x 16	1035	340	0.12	0.085	0.68	L2	99114E3
	1000	16 x 16 x 21	1100	500	0.12	0.080	0.64	L2	99115E3
	1000	18 x 18 x 16	1074	500	0.12	0.085	0.68	L2	99116E3
	1500	18 x 18 x 21	1470	750	0.12	0.080	0.64	L2	99117E3
63	330	16 x 16 x 16	910	208	0.10	0.150	1.20	L2	99816E3
	470	16 x 16 x 21	987	296	0.10	0.120	0.96	L2	99817E3
	470	18 x 18 x 16	944	296	0.10	0.150	1.20	L2	99818E3
	680	18 x 18 x 21	1160	428	0.10	0.120	0.96	L2	99819E3
80	330	16 x 16 x 16	1000	264	0.10	0.180	1.44	L1	99705E3
	470	16 x 16 x 21	1400	376	0.10	0.120	0.96	L1	99706E3
	470	18 x 18 x 16	1050	376	0.10	0.160	1.28	L1	99707E3
	680	18 x 18 x 21	1450	544	0.10	0.110	0.88	L1	99708E3
100	220	16 x 16 x 16	1000	220	0.10	0.180	1.44	L1	99909E3
	330	16 x 16 x 21	1400	330	0.10	0.120	0.96	L1	99911E3
	330	18 x 18 x 16	1050	330	0.10	0.160	1.28	L1	99912E3
	470	18 x 18 x 21	1450	470	0.10	0.110	0.80	L1	99913E3

Note

⁽¹⁾ Determines the applicable row in the table "Endurance Test Duration and Useful Life"

Table 6

EXTENDED VIBRATION SPECIFICATIONS		
PARAMETER	PROCEDURE	REQUIREMENTS
Vibration improvement	From 10 g to 30 g	No visible damage; no leakage of electrolyte; marking legible $\Delta C/C: \pm 5\%$ with respect to initial measurements
Vibration frequency range	10 Hz to 2 kHz	
Vibration profile	<ul style="list-style-type: none"> • Constant sinus sweep (1 oct./min.) • 3 directions • 8 h per direction 	

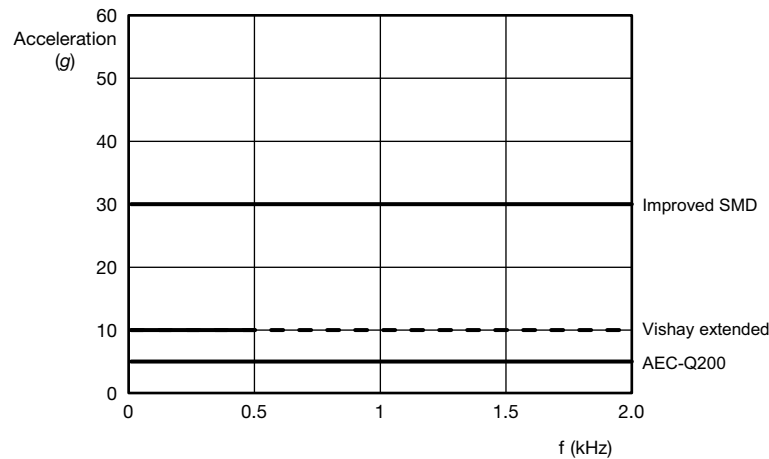

Fig. 5 - Vibration profile

Table 7

ADDITIONAL ELECTRICAL DATA		
PARAMETER	CONDITIONS	VALUE
Voltage		
Surge voltage for short periods	IEC 60384-18, subclause 4.14	$U_s \leq 1.1 \times U_R$
Reverse voltage for short periods	IEC 60384-18, subclause 4.16	$U_{rev} \leq 1 V$
Current		
Leakage current	After 2 min at U_R	$I_{L2} \leq 0.01 \times C_R \times U_R$
Inductance		
Equivalent series inductance (ESL)	$\varnothing D \geq 16 \text{ mm}$	Typ. 11 nH
Resistance		
Equivalent series resistance (ESR) at 100 Hz	Calculated from $\tan \delta_{max}$ and C_R (see Table 6)	$ESR = \tan \delta / 2\pi f C_R$

CAPACITANCE

 C_0 = capacitance at 20 °C, 100 Hz

Fig. 6 - Typical multiplier of capacitance as a function of temperature at 100 Hz

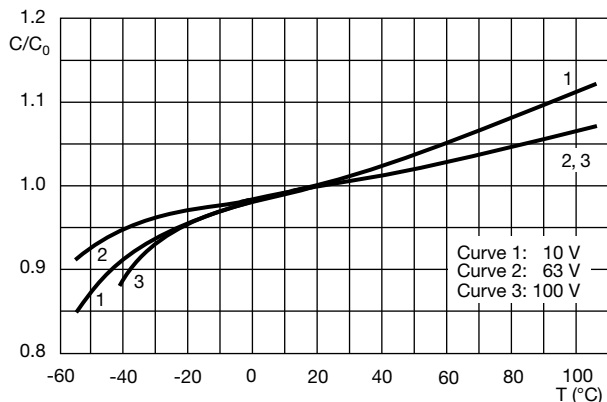

 C_0 = typical capacitance at 20 °C, 100 Hz

Fig. 7 - Typical multiplier of capacitance as a function of frequency at 20 °C

EQUIVALENT SERIES RESISTANCE (ESR)

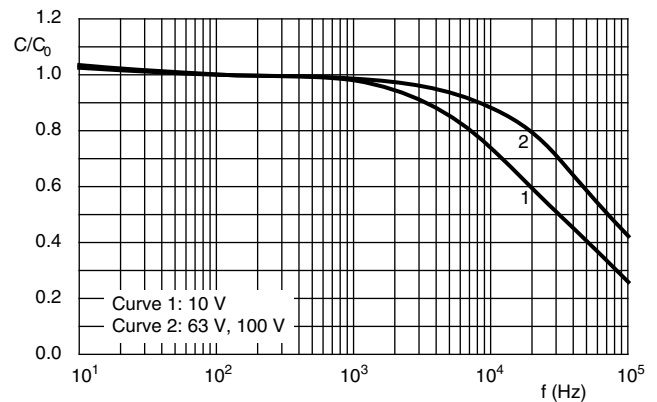
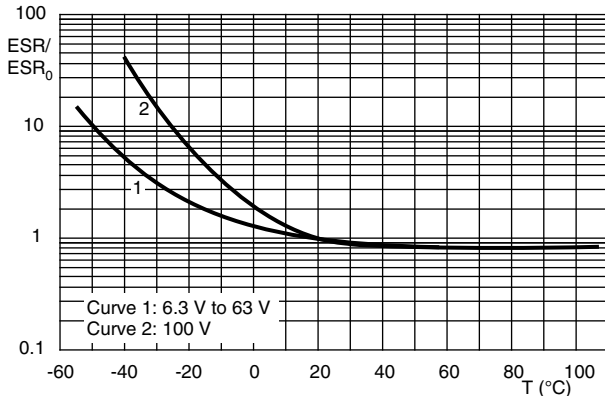

ESR_0 = typical ESR at 20 °C, 100 Hz

Fig. 8 - Typical multiplier of ESR as a function of temperature at 100 Hz

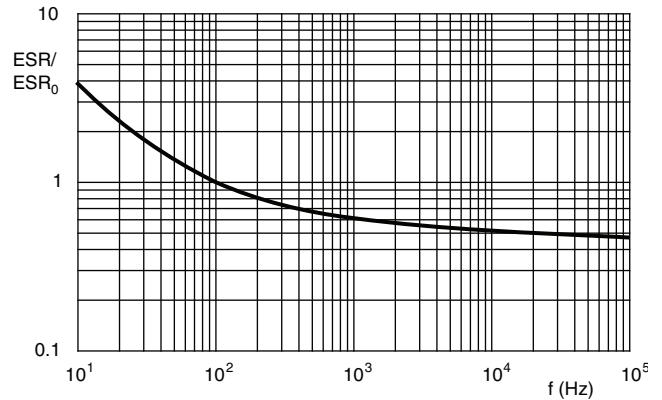

ESR_0 = typical ESR at 20 °C, 100 Hz

Fig. 9 - Typical multiplier ESR as a function of frequency at 20 °C

DISSIPATION FACTOR (tan δ)

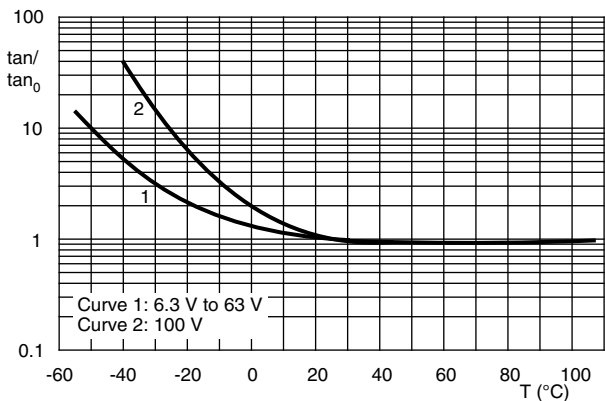

$\tan \delta_0$ = typical $\tan \delta$ at 20 °C, 100 Hz

Fig. 10 - Typical multiplier of dissipation factor $\tan \delta$ as a function of temperature at 20 °C at 100 Hz

IMPEDANCE (Z)

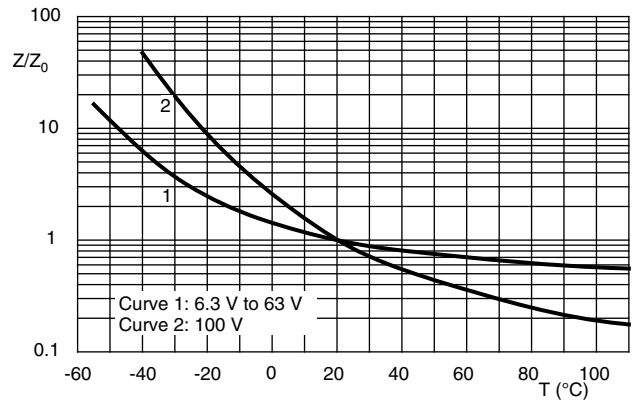

Z_0 = typical impedance Z at 20 °C, 100 kHz

Fig. 11 - Typical multiplier of impedance Z as a function of temperature at 100 kHz

IMPEDANCE (Z)

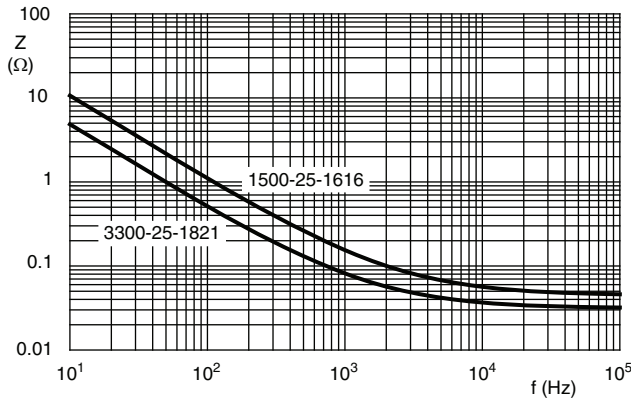

Fig. 12 - Typical impedance Z as a function of frequency at 20 °C

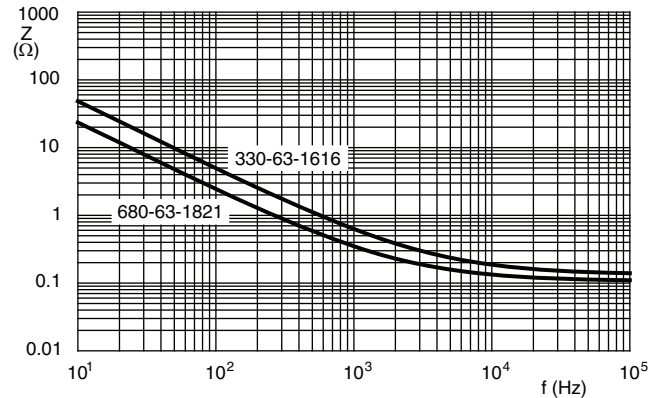

Fig. 13 - Typical impedance Z as a function of frequency at 20 °C

RIPPLE CURRENT AND USEFUL LIFE

Table 8

ENDURANCE TEST DURATION AND USEFUL LIFE			
LIFE CODE	ENDURANCE AT 105 °C (h)	USEFUL LIFE AT 105 °C (h)	USEFUL LIFE AT 40 °C 1.8 x I _R APPLIED (h)
L1	3000	5000	250 000
L2	8000	10 000	500 000

Note

- Multiplier of useful life code: CCC206

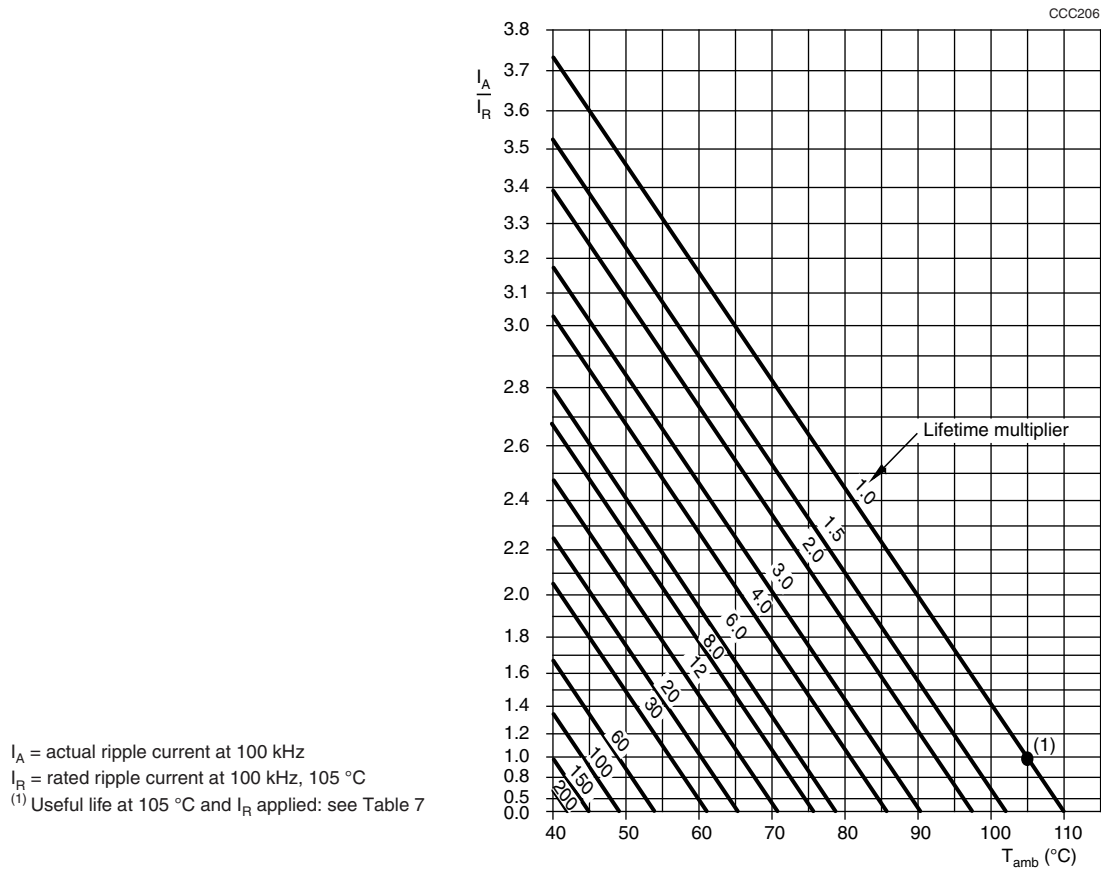

Fig. 14 - Multiplier of useful life as a function of ambient temperature and ripple current load

Table 9

V _R (V)	MULTIPLIER OF RIPPLE CURRENT (I _R) AS A FUNCTION OF FREQUENCY						
	FREQUENCY (Hz)						
	100	300	1000	3000	10 000	30 000	100 000
I _R MULTIPLIER							
6.3	0.70	0.80	0.85	0.93	0.95	0.97	1.00
10	0.70	0.80	0.85	0.93	0.95	0.97	1.00
16	0.70	0.80	0.85	0.93	0.95	0.97	1.00
25	0.70	0.80	0.85	0.93	0.95	0.97	1.00
35	0.65	0.80	0.85	0.93	0.95	0.97	1.00
50	0.60	0.75	0.85	0.93	0.95	0.97	1.00
63	0.60	0.75	0.85	0.93	0.95	0.97	1.00
80	0.60	0.75	0.85	0.93	0.95	0.97	1.00
100	0.60	0.75	0.85	0.93	0.95	0.97	1.00



Table 10

TEST PROCEDURES AND REQUIREMENTS			
TEST		PROCEDURE (quick reference)	REQUIREMENTS
NAME OF TEST	REFERENCE		
Mounting	IEC 60384-18, subclause 4.3	Shall be performed prior to tests mentioned below; reflow soldering; for maximum temperature load refer to chapter "Mounting"	$\Delta C/C: \pm 5 \%$ $\tan \delta \leq \text{spec. limit}$ $I_{L2} \leq \text{spec. limit}$
Endurance	IEC 60384-18 / CECC32300, subclause 4.15	$T_{amb} = 105 \text{ }^\circ\text{C}$; U_R applied; for test duration see Table 8	$U_R = 6.3 \text{ V}$; $\Delta C/C: \pm 25 \%$ $U_R \geq 10 \text{ V}$; $\Delta C/C: \pm 20 \%$ $\tan \delta \leq 2 \times \text{spec. limit}$ $I_{L2} \leq \text{spec. limit}$
Useful life	CECC 30301, subclause 1.8.1	$T_{amb} = 105 \text{ }^\circ\text{C}$; U_R and I_R applied; for test duration see Table 8	$\Delta C/C: \pm 30 \%$ $\tan \delta \leq 3 \times \text{spec. limit}$ $I_{L2} \leq \text{spec. limit}$ no short or open circuit total failure percentage: $\leq 1 \%$
Shelf life (storage at high temperature)	IEC 60384-18 / CECC32300, subclause 4.17	$T_{amb} = 105 \text{ }^\circ\text{C}$; no voltage applied; 1000 h after test: U_R to be applied for 30 min, 24 h to 48 h before measurement	For requirements see "Endurance test" above

Statements about product lifetime are based on calculations and internal testing. They should only be interpreted as estimations. Also due to external factors, the lifetime in the field application may deviate from the calculated lifetime. In general, nothing stated herein shall be construed as a guarantee of durability.



Disclaimer

ALL PRODUCT, PRODUCT SPECIFICATIONS AND DATA ARE SUBJECT TO CHANGE WITHOUT NOTICE TO IMPROVE RELIABILITY, FUNCTION OR DESIGN OR OTHERWISE.

Vishay Intertechnology, Inc., its affiliates, agents, and employees, and all persons acting on its or their behalf (collectively, "Vishay"), disclaim any and all liability for any errors, inaccuracies or incompleteness contained in any datasheet or in any other disclosure relating to any product.

Vishay makes no warranty, representation or guarantee regarding the suitability of the products for any particular purpose or the continuing production of any product. To the maximum extent permitted by applicable law, Vishay disclaims (i) any and all liability arising out of the application or use of any product, (ii) any and all liability, including without limitation special, consequential or incidental damages, and (iii) any and all implied warranties, including warranties of fitness for particular purpose, non-infringement and merchantability.

Statements regarding the suitability of products for certain types of applications are based on Vishay's knowledge of typical requirements that are often placed on Vishay products in generic applications. Such statements are not binding statements about the suitability of products for a particular application. It is the customer's responsibility to validate that a particular product with the properties described in the product specification is suitable for use in a particular application. Parameters provided in datasheets and / or specifications may vary in different applications and performance may vary over time. All operating parameters, including typical parameters, must be validated for each customer application by the customer's technical experts. Product specifications do not expand or otherwise modify Vishay's terms and conditions of purchase, including but not limited to the warranty expressed therein.

Hyperlinks included in this datasheet may direct users to third-party websites. These links are provided as a convenience and for informational purposes only. Inclusion of these hyperlinks does not constitute an endorsement or an approval by Vishay of any of the products, services or opinions of the corporation, organization or individual associated with the third-party website. Vishay disclaims any and all liability and bears no responsibility for the accuracy, legality or content of the third-party website or for that of subsequent links.

Except as expressly indicated in writing, Vishay products are not designed for use in medical, life-saving, or life-sustaining applications or for any other application in which the failure of the Vishay product could result in personal injury or death. Customers using or selling Vishay products not expressly indicated for use in such applications do so at their own risk. Please contact authorized Vishay personnel to obtain written terms and conditions regarding products designed for such applications.

No license, express or implied, by estoppel or otherwise, to any intellectual property rights is granted by this document or by any conduct of Vishay. Product names and markings noted herein may be trademarks of their respective owners.