



■ Features :

- Universal AC input / Full range
- Built-in active PFC function, PF>0.95
- High efficiency up to 89.5%
- Withstand 300VAC surge input for 5 seconds
- Protections: Short circuit / Overload / Over voltage / Over temperature
- Built-in constant current limiting circuit
- Built-in cooling Fan ON-OFF control
- Built-in DC OK signal
- Built-in remote ON-OFF control
- Stand by 5V@0.3A
- Built-in remote sense function
- No load power consumption<0.5W (Note.7)
- 5 years warranty



UL62368-1 BS EN/EN62368-1 TPTC004 IEC62368-1

SPECIFICATION

MODEL	HRPG-450-3.3	HRPG-450-5	HRPG-450-7.5	HRPG-450-12	HRPG-450-15	HRPG-450-24	HRPG-450-36	HRPG-450-48		
OUTPUT	DC VOLTAGE	3.3V	5V	7.5V	12V	15V	24V	36V	48V	
	RATED CURRENT	90A	90A	60A	37.5A	30A	18.8A	12.5A	9.5A	
	CURRENT RANGE	0 ~ 90A	0 ~ 90A	0 ~ 60A	0 ~ 37.5A	0 ~ 30A	0 ~ 18.8A	0 ~ 12.5A	0 ~ 9.5A	
	RATED POWER	297W	450W	450W	450W	450W	451.2W	450W	456W	
	RIPPLE & NOISE (max.) Note.2	80mVp-p	80mVp-p	100mVp-p	120mVp-p	150mVp-p	150mVp-p	240mVp-p	240mVp-p	
	VOLTAGE ADJ. RANGE	2.8 ~ 3.8V	4.3 ~ 5.8V	6.8 ~ 9V	10.2 ~ 13.8V	13.5 ~ 18V	21.6 ~ 28.8V	28.8 ~ 39.6V	40.8 ~ 55.2V	
	VOLTAGE TOLERANCE Note.3	± 2.0%	± 2.0%	± 2.0%	± 1.0%	± 1.0%	± 1.0%	± 1.0%	± 1.0%	
	LINE REGULATION	± 0.5%	± 0.5%	± 0.5%	± 0.3%	± 0.3%	± 0.2%	± 0.2%	± 0.2%	
	LOAD REGULATION	± 1.0%	± 1.0%	± 1.0%	± 0.5%	± 0.5%	± 0.5%	± 0.5%	± 0.5%	
	SETUP, RISE TIME	1000ms, 100ms/230VAC		2500ms, 100ms/115VAC at full load						
HOLD UP TIME (Typ.)	16ms/230VAC		16ms/115VAC at full load							
INPUT	VOLTAGE RANGE Note.5	85 ~ 264VAC		120 ~ 370VDC						
	FREQUENCY RANGE	47 ~ 63Hz								
	POWER FACTOR (Typ.)	PF>0.95/230VAC		PF>0.99/115VAC at full load						
	EFFICIENCY (Typ.)	80%	83%	86.5%	88%	89%	88%	89%	89.5%	
	AC CURRENT (Typ.)	5A/115VAC		2.4A/230VAC						
	INRUSH CURRENT (Typ.)	35A/115VAC		70A/230VAC						
	LEAKAGE CURRENT	<1.5mA / 240VAC								
PROTECTION	OVERLOAD	105 ~ 135% rated output power Protection type : Constant current limiting, recovers automatically after fault condition is removed								
	OVER VOLTAGE	3.96 ~ 4.62V	6 ~ 7V	9.4 ~ 10.9V	14.4 ~ 16.8V	18.8 ~ 21.8V	30 ~ 34.8V	41.4 ~ 48.6V	57.6 ~ 67.2V	
	OVER TEMPERATURE	Shut down o/p voltage, recovers automatically after temperature goes down								
FUNCTION	5V STANDBY	5VSB : 5V@0.3A ; tolerance ± 5%, ripple : 50mVp-p(max.)								
	DC OK SIGNAL	PSU turn on : 3.3 ~ 5.6V ; PSU turn off : 0 ~ 1V								
	REMOTE CONTROL	RC+ / RC-: 4 ~ 10V or open = power on ; 0 ~ 0.8V or short = power off								
	FAN CONTROL (Typ.)	Load 20 ± 10% or RTH2 ≥ 50°C Fan on								
ENVIRONMENT	WORKING TEMP.	-40 ~ +70°C (Refer to "Derating Curve")								
	WORKING HUMIDITY	20 ~ 90% RH non-condensing								
	STORAGE TEMP., HUMIDITY	-40 ~ +85°C, 10 ~ 95% RH non-condensing								
	TEMP. COEFFICIENT	± 0.03%/°C (0 ~ 50°C)								
	VIBRATION	10 ~ 500Hz, 5G 10min./1cycle, 60min. each along X, Y, Z axes								
SAFETY & EMC (Note 4)	SAFETY STANDARDS	UL62368-1, TUV BS EN/EN62368-1, EAC TP TC 004 approved								
	WITHSTAND VOLTAGE	I/P-O/P:3KVAC		I/P-FG:2KVAC		O/P-FG:0.5KVAC				
	ISOLATION RESISTANCE	I/P-O/P, I/P-FG, O/P-FG:100M Ohms / 500VDC / 25°C / 70% RH								
	EMC EMISSION	Compliance to BS EN/EN55032 (CISPR32) Class B, BS EN/EN61000-3-2, -3, EAC TP TC 020								
	EMC IMMUNITY	Compliance to BS EN/EN61000-4-2,3,4,5,6,8,11, BS EN/EN55024, BS EN/EN61000-6-2, heavy industry level, criteria A, EAC TP TC 020								
OTHERS	MTBF	130.5K hrs min. MIL-HDBK-217F (25°C)								
	DIMENSION	218*105*41mm (L*W*H)								
	PACKING	1.19Kg; 12pcs/15.3Kg/0.82CUFT								
NOTE	<p>1. All parameters NOT specially mentioned are measured at 230VAC input, rated load and 25°C of ambient temperature.</p> <p>2. Ripple & noise are measured at 20MHz of bandwidth by using a 12" twisted pair-wire terminated with a 0.1uf & 47uf parallel capacitor.</p> <p>3. Tolerance : includes set up tolerance, line regulation and load regulation.</p> <p>4. The power supply is considered a component which will be installed into a final equipment. All the EMC tests are been executed by mounting the unit on a 360mm*360mm metal plate with 1mm of thickness. The final equipment must be re-confirmed that it still meets EMC directives. For guidance on how to perform these EMC tests, please refer to "EMI testing of component power supplies." (as available on http://www.meanwell.com)</p> <p>5. Derating may be needed under low input voltages. Please check the derating curve for more details.</p> <p>6. Length of set up time is measured at first cold start. Turning ON/OFF the power supply may lead to increase of the set up time.</p> <p>7. No load power consumption<0.5W when RC- & RC+ (CN100 pin1,2) 0 ~ 0.8V or short.</p> <p>8. The ambient temperature derating of 3.5°C/1000m with fanless models and of 5°C/1000m with fan models for operating altitude higher than 2000m(6500ft).</p> <p>※ Product Liability Disclaimer : For detailed information, please refer to https://www.meanwell.com/serviceDisclaimer.aspx</p>									

Mechanical Specification

Case No. 995A Unit:mm

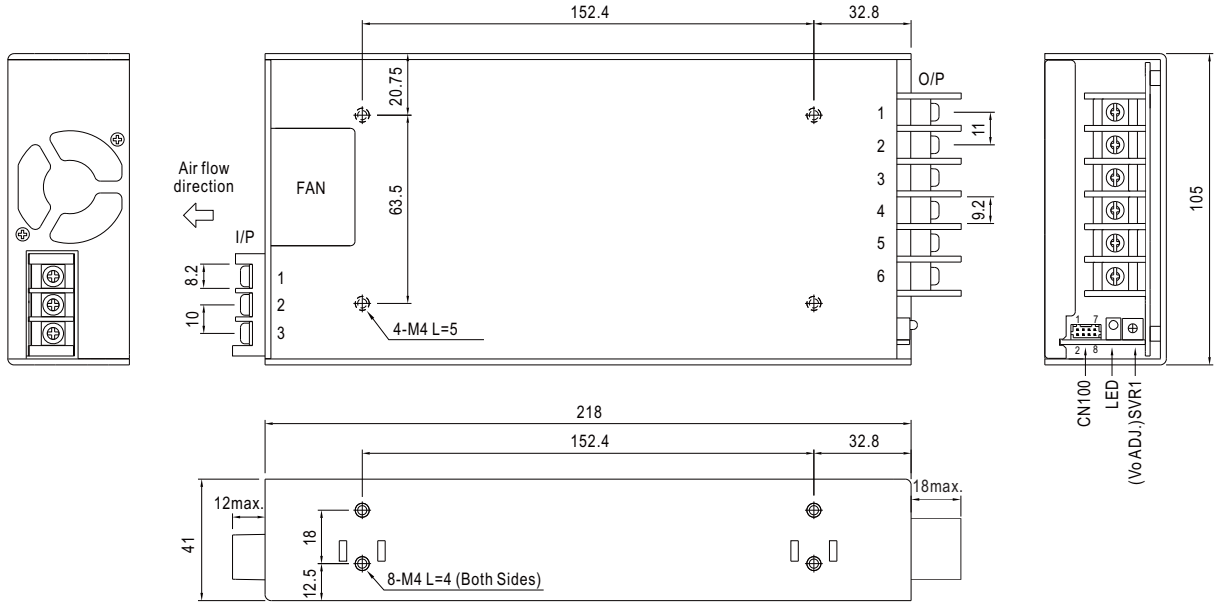

AC Input Terminal Pin No. Assignment

Pin No.	Assignment
1	AC/L
2	AC/N
3	FG \perp

DC Output Terminal Pin No. Assignment

Pin No.	Assignment
1~3	-V
4~6	+V

Connector Pin No. Assignment (CN100) : HRS DF11-8DP-2DS or equivalent

Pin No.	Assignment	Pin No.	Assignment	Mating Housing	Terminal
1	RC+	5	DC-OK	HRS DF11-8DS or equivalent	HRS DF11-**SC or equivalent
2	RC-	6	GND		
3	AUX	7	+S		
4	AUXG	8	-S		

Block Diagram

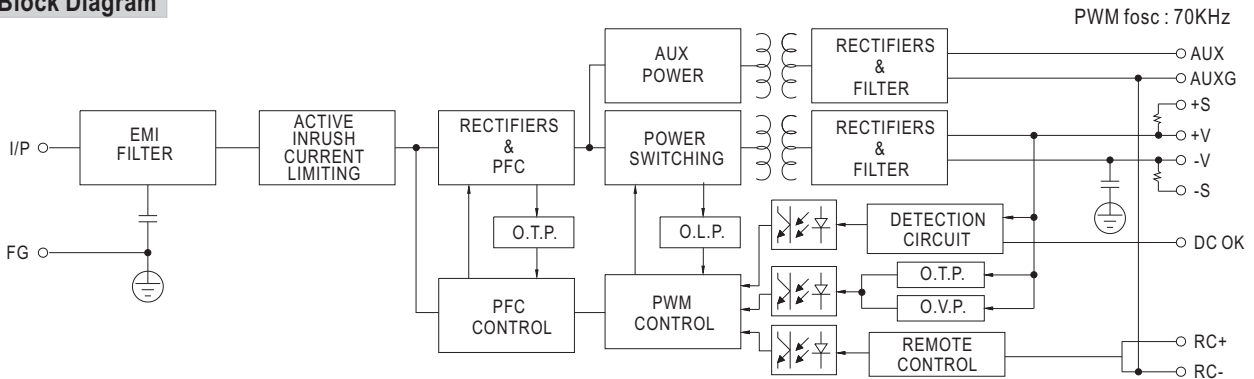

Derating Curve

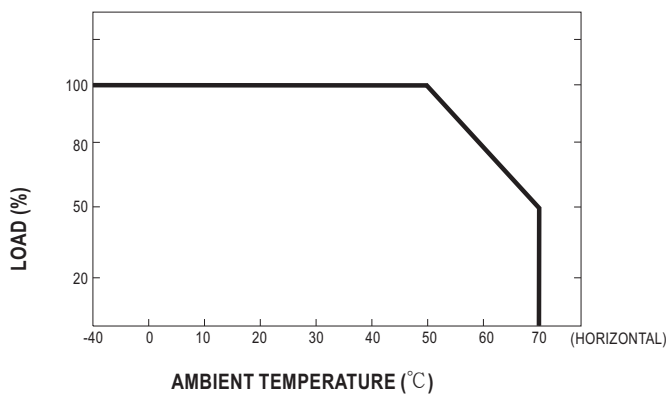

Output Derating VS Input Voltage

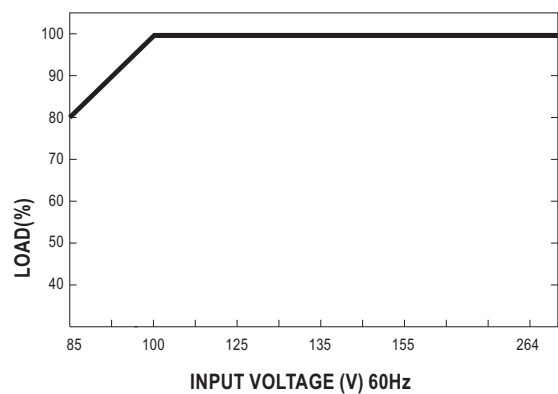

Function Description of CN100

Pin No.	Function	Description
1	RC+	Turns the output on and off by electrical or dry contact between pin 2 (RC-), Short: Power OFF, Open: Power ON.
2	RC-	Remote control ground.
3	AUX	Auxiliary voltage output, 4.75~5.25V, referenced to pin 4(AUXG). The maximum load current is 0.3A. This output is not controlled by the "remote ON/OFF control".
4	AUXG	Auxiliary voltage output ground. The signal return is isolated from the output terminals (+V & -V).
5	DC-OK	DC-OK Signal is a TTL level signal, referenced to pin6(DC-OK GND). High when PSU turns on.
6	GND	This pin connects to the negative terminal(-V). Return for DC-OK signal output.
7	+S	Positive sensing. The +S signal should be connected to the positive terminal of the load. The +S and -S leads should be twisted in pair to minimize noise pick-up effect. The maximum line drop compensation is 0.5V.
8	-S	Negative sensing. The -S signal should be connected to the negative terminal of the load. The -S and +S leads should be twisted in pair to minimize noise pick-up effect. The maximum line drop compensation is 0.5V.

Function Manual

1. Remote Sense

The remote sensing compensates voltage drop on the load wiring up to 0.5V.

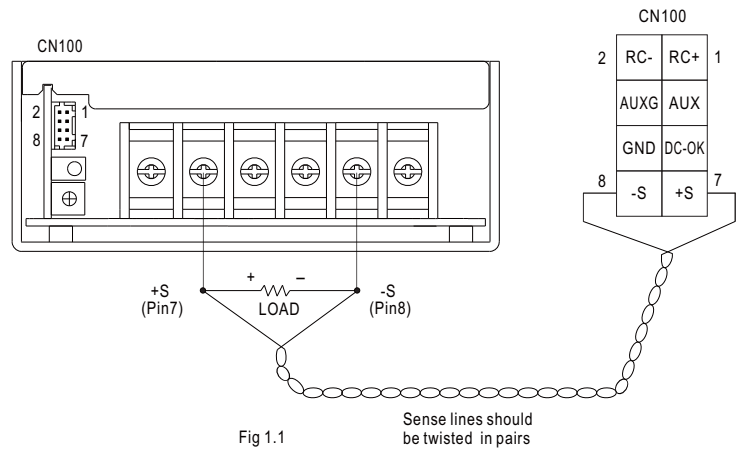

Fig 1.1

2. DC-OK Signal

DC-OK signal is a TTL level signal. High when PSU turns on.

Between DC-OK(pin5) and GND(pin6)	Output Status
3.3 ~ 5.6V	ON
0 ~ 1V	OFF

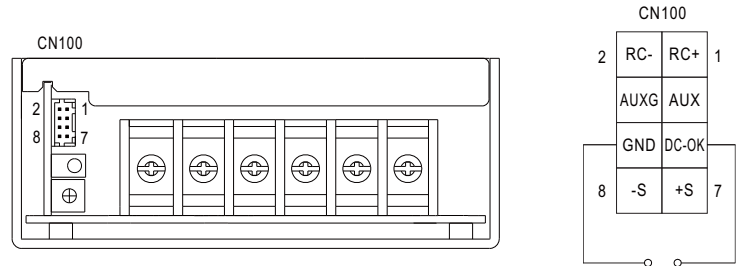

Fig 2.1

3. Remote Control

The PSU can be turned ON/OFF by using the "Remote Control" function.

Between RC+(pin1) and RC-(pin2)	Output Status
SW ON (Short)	OFF
SW OFF (Open)	ON

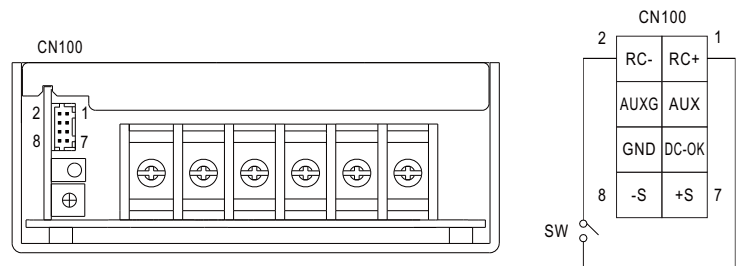

Fig 3.1