

IEC Appliance Inlet C8 with Line Switch 1-pole



CMF1
 IEC connector C8 with line switch 1-pole
 PCB



See below:
[Approvals and Compliances](#)

Description

- Panel mount :
 Screw-on mounting on PCB , from top / bottom
- 2 Functions :
 Appliance Inlet Protection class II , Line Switch 1-pole
- For PCB mounting

Characteristics

- Easy mounting with center bolt and snapper or screwed on PCB or housing
- Electrical connection done on the PCB
- Standard CMF with switch on the right side
- With or without rear-side insulation cover
- Suitable for use in equipment according to IEC/UL 62368-1

Other versions on request

- Line switch with other rocker marking

References

Alternative: polarized version or protection class I [CMF2](#); [CMF3](#)

Weblinks

[pdf data sheet](#), [html datasheet](#), [General Product Information](#), [Approvals](#), [Distributor-Stock-Check](#), [Accessories](#), [Detailed request for product](#)

Technical Data

Ratings IEC	2.5 A / 250 VAC; 50 Hz
Ratings UL/CSA	2.5 A / 250 VAC; 60 Hz 7 A / 125 VAC; 60 Hz
Dielectric Strength	> 2.3 kVAC between L-N > 2.8 kVAC between L/N-PE (1 min/50 Hz)
Allowable Operation Temperature	-25 °C to 70 °C
IP-Protection	front side IP40 acc. to IEC 60529
Protection against electric shock	Suitable for appliances with protection class II acc. to IEC 61140
Terminal	PCB 1.6 mm
Material: Housing	Thermoplastic, black, UL 94V-0

Appliance inlet/-outlet	C8 acc. to IEC 60320-1, UL 60320-1, CSA C22.2 no. 60320-1 (for cold conditions) pin-temperature 70 °C, 2.5 A, Protection Class II
Line Switch	Rocker switch 1-pole, non-illuminated, acc. to IEC 61058-1 Technical Details



Approvals and Compliances

Detailed information on product approvals, code requirements, usage instructions and detailed test conditions can be looked up in [Details about Approvals](#)

SCHURTER products are designed for use in industrial environments. They have approvals from independent testing bodies according to national and international standards. Products with specific characteristics and requirements such as required in the automotive sector according to IATF 16949, medical technology according to ISO 13485 or in the aerospace industry can be offered exclusively with customer-specific, individual agreements by SCHURTER.





Approvals

The approval mark is used by the testing authorities to certify compliance with the safety requirements placed on electronic products.
 Approval Reference Type: CMF

Approval Logo	Certificates	Certification Body	Description
	VDE Approvals	VDE	VDE Certificate Number: 40018468
	UL Approvals	UL	UL File Number: E96454
	CCC Approvals	CCC	CCC Certificate Number: 2007010204227779

Product standards

Product standards that are referenced

Organization	Design	Standard	Description
	Designed according to	IEC 60320-1	Appliance couplers for household and similar general purposes
	Designed according to	IEC 61058-1	Switches for appliances. Part 1. General requirements
	Designed according to	UL 60320-1	Standard for Attachment Plugs and Receptacles
	Designed according to	CSA C22.2 no. 60320-1	General Use Receptacles, Attachment Plugs, and Similar Wiring Devices





Application standards

Application standards where the product can be used

Organization	Design	Standard	Description
	Designed for applications acc.	IEC/UL 62368-1	IEC 62368-1 includes the basic requirements for safety of audio, video, information technology and office equipment.

Compliances

The product complies with following Guide Lines

Identification	Details	Initiator	Description
	CE declaration of conformity	SCHURTER AG	The CE marking declares that the product complies with the applicable requirements laid down in the harmonisation of Community legislation on its affixing in accordance with EU Regulation 765/2008.
	RoHS	SCHURTER AG	Directive RoHS 2011/65/EU, Amendment (EU) 2015/863
	China RoHS	SCHURTER AG	The law SJ / T 11363-2006 (China RoHS) has been in force since 1 March 2007. It is similar to the EU directive RoHS.
	REACH	SCHURTER AG	On 1 June 2007, Regulation (EC) No 1907/2006 on the Registration, Evaluation, Authorization and Restriction of Chemicals 1 (abbreviated as "REACH") entered into force.

Dimensions [mm]

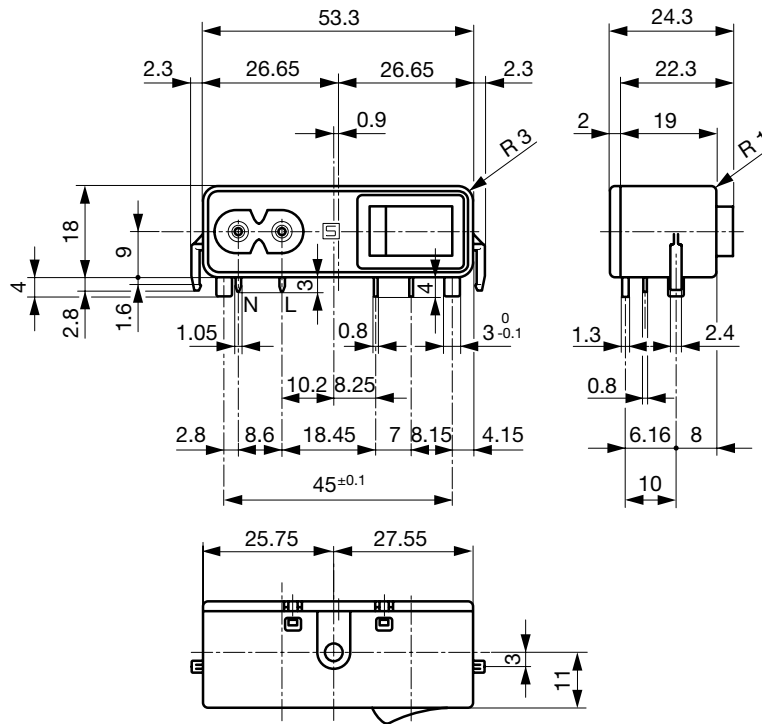

With insulation cover
 The size of the mounting cut-out can be selected as required.

Drilling Diagram / CMF1 and CMF2

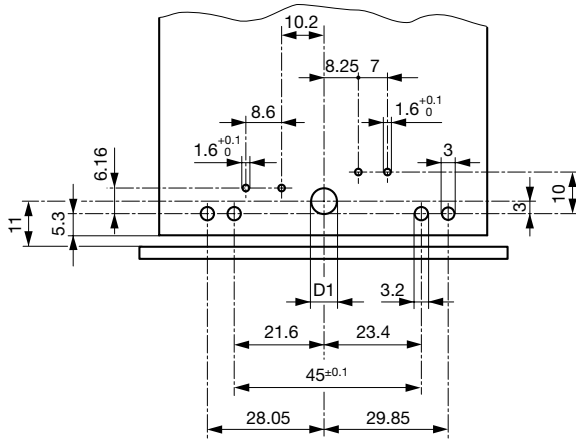

D1 = 6.2 mm mounting from above
 D1 = 3.6 mm mounting from below

Fixation on PCB or housing from below

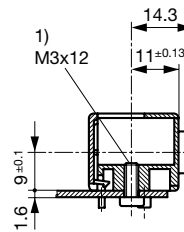

1) self tapping screw

Fixation on PCB or housing from above

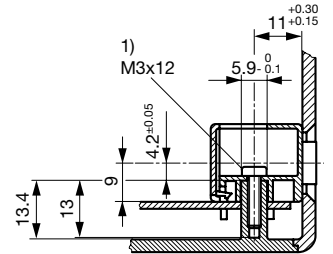

1) self tapping screw

All Variants

Connectors	Mounting side	Cover	Ground terminal	Ground terminal direction	Order Number
C8	from below	with cover	-	-	CMF1.1131.12
C8	from below	without cover	-	-	CMF1.1031.12
C8	from top	with cover	-	-	CMF1.1111.12
C8	from top	without cover	-	-	CMF1.1011.12

Most Popular.

Availability for all products can be searched real-time: <https://www.schurter.com/en/Stock-Check/Stock-Check-SCHURTER>

Packaging unit

50 Pcs

The specifications, descriptions and illustrations indicated in this document are based on current information. All content is subject to modifications and amendments. Information furnished is believed to be accurate and reliable. However, users should independently evaluate the suitability and test each product selected for their own applications.