

User Manual for

Pilot Gateway Pro RAK7243

WisDevice RAK72x Series

LoRa Gateway Kit with Cellular & GPS

Version V1.1 | January 2019



www.RAKwireless.com

Visit our website for more document.

18 PAGES



Table of Contents

1 Overview.....	4
1.1 Introduction.....	4
1.2 Main Features.....	5
1.3 Package Contents.....	5
2 Pilot Gateway Pro RAK7243.....	6
2.1 Overview.....	6
2.2 Interfaces.....	6
2.3 System Structure.....	7
2.4 LoRa Operating Frequencies.....	7
2.5 Cellular Frequency Bands.....	8
2.5.1 BG96 Module.....	8
2.5.2 EG91 Module.....	8
2.5.3 EG95 Module.....	8
2.6 Hardware Structure.....	9
2.6.1 LoRa Concentrator RAK2245 Pi HAT.....	9
2.6.2 Cellular Board RAK2013 Pi HAT.....	9
2.7 Power Requirements.....	10
2.8 Environmental Requirements.....	10
2.9 LoRa RF Characteristics.....	11
2.9.1 Transmitter RF Characteristics.....	11
2.9.2 Receiver RF Characteristics.....	12
3 Antenna.....	13
3.1 LoRa Antenna.....	13
3.1.1 Overview.....	13
3.1.2 Antenna Dimension.....	13
3.1.3 Antenna Parameter.....	13
3.2 LTE Antenna.....	13
3.2.1 Overview.....	14
3.2.2 Antenna Dimension.....	14
3.2.3 Antenna Parameter.....	14
3.3 GPS Antenna.....	15
3.3.1 Overview.....	15
3.3.2 GPS Antenna Dimensions.....	15
3.3.3 GPS Environmental Requirements.....	15
3.3.4 GPS Antenna Parameter.....	15
4 Flash the Gateway Image.....	17
5 Contact Information.....	17
6 Revision History.....	18
7 Document Summary.....	18

List of Tables

Table 1	LoRa Operating Frequencies.....	7
Table 2	BG96 Frequency Bands.....	8
Table 3	EG91 Frequency Bands.....	8
Table 4	EG95 Frequency Bands.....	8
Table 5	Power Requirements.....	10
Table 6	Environment Requirements.....	10
Table 7	RF Output Power Level.....	11
Table 8	TX RF Characteristics.....	11
Table 9	RX RF Characteristics.....	12
Table 10	LoRa Antenna Parameter.....	13
Table 11	LTE Antenna Parameter.....	14
Table 12	GPS Environmental Requirements.....	15
Table 13	GPS Antenna Parameter.....	16
Table 14	Amplifier Specifications.....	16
Table 15	Environmental Test Performance.....	16

List of Figures

Figure 1	Pilot Gateway Pro Overview.....	5
Figure 2	Package Contents.....	5
Figure 3	Outer Dimensions.....	6
Figure 4	Interfaces.....	6
Figure 5	Pilot Gateway Pro System Structure.....	7
Figure 6	LoRa Hardware Structure.....	9
Figure 7	Cellular Hardware Structure.....	10
Figure 8	LoRa Antenna Overview.....	13
Figure 9	LoRa Antenna Dimension.....	13
Figure 10	LTE Antenna.....	14
Figure 11	LTE Antenna Dimension.....	14
Figure 12	GPS Antenna.....	15
Figure 13	GPS Antenna Dimensions.....	15

1 Overview

1.1 Introduction

The RAK7243 Pilot Gateway Pro is a device that consists of Raspberry Pi 3B+, RAK2245 Pi HAT which includes a GPS module and a Heat Sink for better performance and thermal heat dissipation management, and an optional RAK2013 Cellular Pi HAT. And it's housing is built with an aluminum casing.

For the build-in RAK2245 Pi HAT, it uses the SX1301 chip from Semtech which built-in LoRa concentrator IP core is a powerful digital signal processing engine. It is able to receive up to 8 LoRa packets simultaneously sent with different spreading factors on different channels and available in multiple variants so it can be used for international standard bands. This unique capability allows to implement innovative network architectures advantageous over other short range systems. For the build-in RAK2013 Cellular Pi HAT, it supports optional QUECTEL BG96 / EG91 / EG95 which can support NB-IOT / CAT-M / CAT1 LTE / CAT4 LTE. It follows Raspberry Pi specifications and is easy to mount with Raspberry Pi and RAK2245 Pi HAT module.

Pilot Gateway Pro is ideal for prototyping, proof-of-concept demonstration or for the evaluation. It includes a ready to use LoRaWan Gateway OS that can be connected to a LoRaWan server. Also it is developer friendly and simple even for no-so-techy users to set up LoRaWan system. It has to be the best value and function for connectivity to address a variety of applications like Smart Grid, Intelligent Farm and other IoT enterprise applications.

Note : All Quectel BG96,EG91,EG95 are option . Anyone or Even None.



Figure 1 | Pilot Gateway Pro Overview

1.2 Main Features

- Computing with Raspberry Pi 3B+(Linux).
- SX1301 base band processor, emulates 49 x LoRa demodulators 10 programmable parallel demodulation paths, support 8 uplinks channel, 1 downlink channel.
- Support optional Cellular module(Quectel BG96 or EG91 or EG95) for NB-IOT / CAT-M / CAT1 LTE / CAT4 LTE.
- Built-in the Ublox MAX-7Q GPS Module.
- Built-in Heat Sink for thermal heat dissipation management.
- Supports 5V/2.5A power supply.
- TX power up to 27dBm, RX sensitivity down to -139dBm@SF12, BW 125KHz.
- LoRa frequency supports global license-free frequency band (EU433, CN470, EU868, US915, AS923, AU915, KR920, IN865 and AS920).
- Housing with top cover, body, bottom cover with riveted motherboard standoff.
- Includes Pi ready 'ID EEPROM', GPIO setup and device tree can be automatically configured from vendor information.
- Supports fully open source code connected to a LoRaWAN server.

1.3 Package Contents



Figure 2 | Package Contents

Note: LTE Antenna only for BG96 / EG91 / EG95 version. BG96 version includes 1x LTE Antenna, EG91 / EG95 version includes 2x LTE Antenna.

2 Pilot Gateway Pro RAK7243

2.1 Overview

The outer dimension of Pilot Gateway Pro is 92 x 68.3 x 53.5 mm as shown below.



Figure 3 | Outer Dimensions

2.2 Interfaces

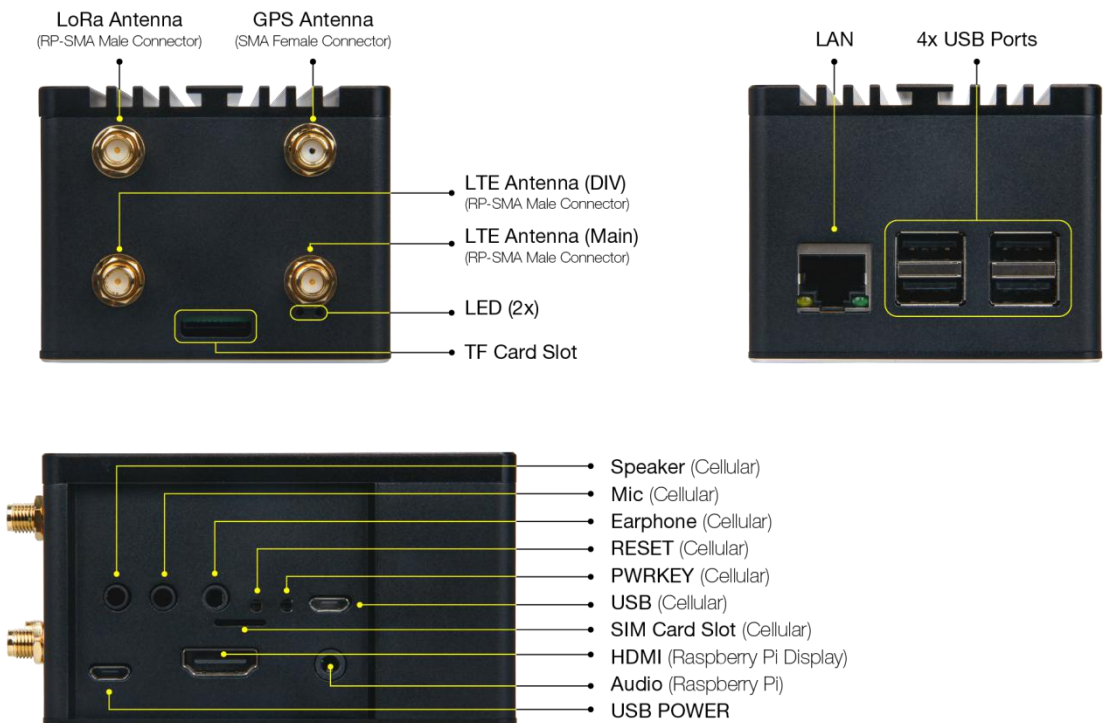

Figure 4 | Interfaces

Note: LTE Antenna(DIV) is only using for the EG91 / EG95 Version and reserved for BG96 Version.

2.3 System Structure

The following figure shows the basic concept for LoRaWAN system. RAK7243 Pilot Gateway Pro is the central hardware solution for all LoRa based radio communication. It receives and transmits radio messages. The processing of radio messages as well as the protocol related tasks is done by embedded host system (Raspberry Pi). Received and processed radio messages are being sent to a LoRaWAN server. The concrete segmentation of the protocol related tasks is outside the scope of this document.

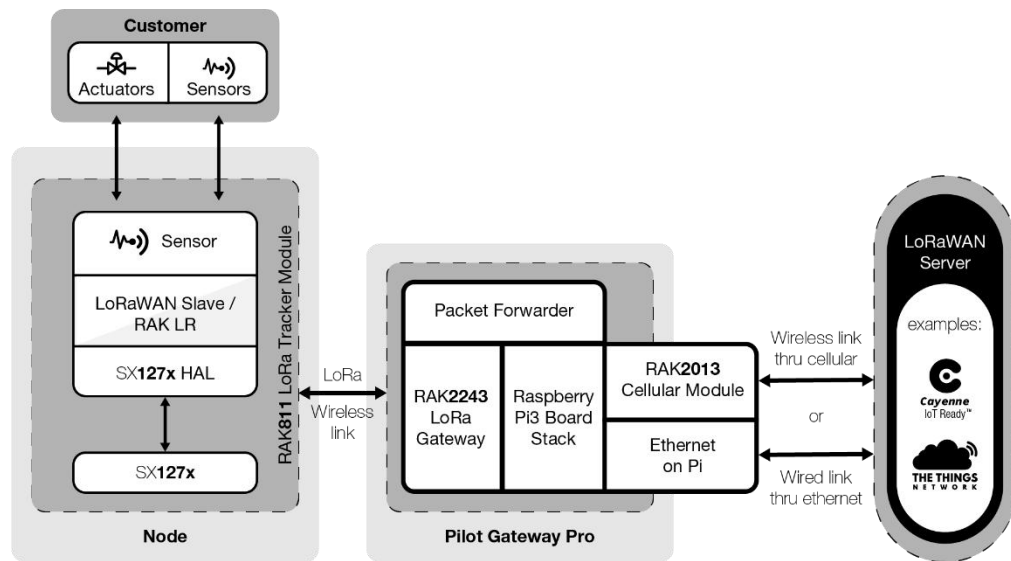

Figure 5 | Pilot Gateway Pro System Structure

2.4 LoRa Operating Frequencies

The Pilot Gateway Pro supports all LoRaWAN frequency channels as below. Which is easy to configure while building the firmware from the source code.

Region	Frequency (MHz)
Europe	EU433, EU868
China	CN470
North America	US915
Asia	AS923, AS920
Australia	AU915
Korea	KR920
Indian	IN865

Table 1 | LoRa Operating Frequencies

2.5 Cellular Frequency Bands

The Pilot Gateway Pro supports different frequency bands according to the modular mounted on the board.

2.5.1 BG96 Module

BG96 is a series of LTE Cat M1/Cat NB1/EGPRS module offering a maximum data rate of 300Kbps downlink and 375Kbps uplink.

Frequency		BG96
LTE	FDD-LTE	B1 / B2 / B3 / B4 / B5 / B8 / B12 / B13 / B18 / B19 / B20 / B26 / B28
	TDD-LTE	B39 (for CAT M1 only)
EGPRS		850 / 900 / 1800 / 1900 MHz

Table 2 | BG96 Frequency Bands

2.5.2 EG91 Module

Quectel EG91 is a series of LTE category 1 module optimized specially for M2M and IoT applications. It delivers M2M-optimized speeds of 10Mbps downlink and 5Mbps uplink. These make EG91 an ideal solution for numerous IoT applications that are not reliant on high speed connectivity but still require the longevity and reliability of LTE networks.

Frequency	EG91-E	EG91-NA
LTE FDD	B1 / B3 / B7 / B8 / B20 / B28A	B2 / B4 / B5 / B12 / B13
WCDMA	B1 / B8	B2 / B4 / B5
GSM / EDGE	900 / 1800 MHz	
Region	Europe	North America

Table 3 | EG91 Frequency Bands

2.5.3 EG95 Module

Quectel EG95 is a series of LTE category 4 module optimized specially for M2M and IoT applications. Adopting 3GPP Rel. 11 LTE technology, it delivers 150Mbps downlink and 50Mbps uplink data rates.

Frequency	EG95-E	EG95-NA
LTE FDD	B1 / B3 / B7 / B8 / B20 / B28A	B2 / B4 / B5 / B12 / B13
WCDMA	B1 / B8	B2 / B4 / B5
GSM / EDGE	900 / 1800 MHz	
Region	Europe	North America

Table 4 | EG95 Frequency Bands

2.6 Hardware Structure

2.6.1 LoRa Concentrator RAK2245 Pi HAT

RAK2245 Pi HAT (Model Name is: RAK2243) is a LoRa Concentrator board which follows the Pi HAT standard, and can be mounted to Pi board with 40-pin connector.

For detailed information about RAK2243, please refer to the datasheet as: [RAK2245_Pi_Hat_User_Manual_V1.0.pdf](#)

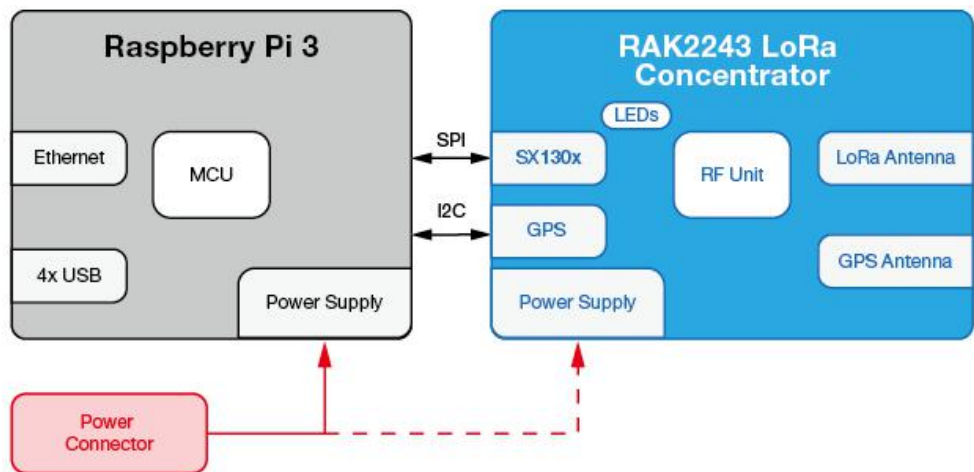

Figure 6 | LoRa Hardware Structure

2.6.2 Cellular Board RAK2013 Pi HAT

RAK2013 is an add-on board following Raspberry Pi HAT standard. It can transmit UART data from Raspberry Pi to Cellular network. It can support several cellular protocol, such as NB-IOT, CAT-M, CAT1 or CAT 4, by choosing different modular on the board.

The RAK2013 integrates audio codec and audio amplifier on it, with carrier operator's network, it can support VoLTE function. For easy use, there are earphone connector, MIC connector and speaker connector with audio amplifier.

For detailed information about RAK2013, please refer to the datasheet of: [RAK2013_User_Manual_V1.0.pdf](#)

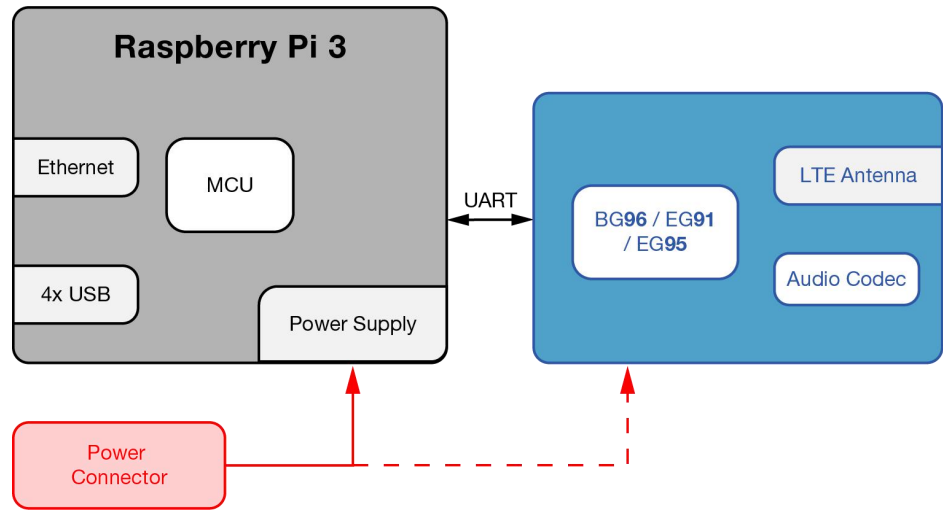

Figure 7 | Cellular Hardware Structure

2.7 Power Requirements

The Pilot Gateway Pro operates at 5V/2.5A. It can be powered by micro USB with 5V.

Parameter	Min.	Typical	Max.
Current in CAT M mode	-	300mA	-
Current in GSM mode (peak)	-	-	3500mA
Cellular power off mode	-	10mA	-

Table 5 | Power Requirements

2.8 Environmental Requirements

The table below lists the operation and storage temperature requirements:

Parameter	Min.	Typical	Max.
Operation Temperature Range	-20 °C	+25 °C	+65 °C
Extended Temperature Range	-40 °C		+85 °C
Storage Temperature Range	-40 °C		+85 °C

Table 6 | Environment Requirements

2.9 LoRa RF Characteristics

2.9.1 Transmitter RF Characteristics

The RAK2245 has an excellent transmitter performance. It is highly recommended to use an optimized configuration for the power level configuration, which is part of the HAL. This results in a mean RF output power level and current consumption.

PA Control	DAC Control	MIX Control	DIG Gain	Nominal RF Power Level
0	3	8	0	-6 dBm
0	3	10	0	-3 dBm
0	3	14	0	0
1	3	9	3	4 dBm
1	3	8	0	8 dBm
1	3	9	0	10 dBm
1	3	11	0	12 dBm
1	3	12	0	14 dBm
1	3	13	0	16 dBm
2	3	12	0	17 dBm
2	3	13	0	19 dBm
2	3	14	0	20 dBm
3	3	10	0	0
3	3	11	0	0
3	3	12	0	25 dBm
3	3	13	0	26 dBm
3	3	14	0	27 dBm

Table 7 | RF Output Power Level

T=25°C, VDD=5V(Typ.) if nothing else stated.

Parameter	Condition	Min	Typ.	Max
Frequency Range		863 MHz		870 MHz
Modulation Techniques	FSK/LoRaTM			
TX Frequency Variation vs. Temperature	Power Level Setting : 20	-3 KHz		+3 KHz
TX Power Variation vs. Temperature		-5 dBm		+5 dBm
TX Power Variation		-1.5 dBm		+1.5 dBm

Table 8 | TX RF Characteristics

2.9.2 Receiver RF Characteristics

It is highly recommended, to use optimized RSSI calibration values, which is part of the HAL v3.1. For both, Radio 1 and 2, the RSSI-Offset should be set -169.0. The following table gives typically sensitivity level of the RAK2245.

Signal Bandwidth / [KHz]	Spreading Factor	Sensitivity / [dBm]
125	12	-139
125	7	-126
250	12	-136
250	7	-123
500	12	-134
500	7	-120

Table 9 | RX RF Characteristics

3 Antenna

3.1 LoRa Antenna

3.1.1 Overview

The LoRa Antenna with RP-SMA female connector shown as follow figures.



Figure 8 | LoRa Antenna Overview

3.1.2 Antenna Dimension

The antenna's mechanical dimension is shown below:

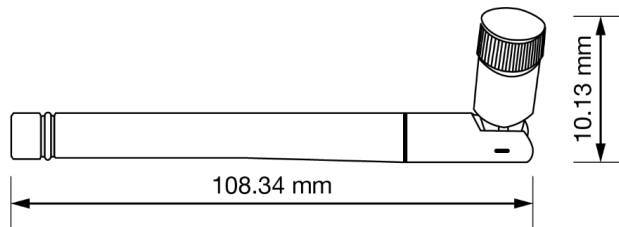

Figure 9 | LoRa Antenna Dimension

3.1.3 Antenna Parameter

Items	Specifications
Voltage Standard Wave Radio (VSWR)	1:1.5
Gain	2.0 dBi
Working Temperature & Humidity	T:-35 °C ~ +80 °C, H: 0% ~ 95%
Storage Temperature & Humidity	T:-40 °C ~ +85 °C, H: 0% ~ 95%

Table 10 | LoRa Antenna Parameter

3.2 LTE Antenna

For module built-in BG96, there is one LTE antenna and one GPS antenna. For module built-in EG91/EG95, there is two LTE antennas, and no GPS antenna with the module.

3.2.1 Overview

The LTE antenna for the Pilot Gateway Pro covers working frequency band from 824MHz to 2690MHz. The antenna is shown as below.



Figure 10 | LTE Antenna

3.2.2 Antenna Dimension

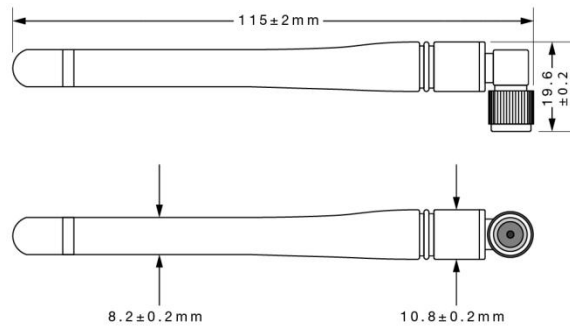

Figure 11 | LTE Antenna Dimension

3.2.3 Antenna Parameter

Items	Specifications						
Frequency(MHz)	700	800	880	960	1710	1880	2170
Voltage Standard Wave Radio (VSWR)	9.3	4.6	3.6	4.9	9.3	4.4	15
Gain(dBi)	1.63	1.84	1.96	2.23	0.03	0.01	1.97
Working Temperature & Humidity	T:-35 °C ~ +80 °C, H: 0% ~ 95%						
Storage Temperature & Humidity	T:-40 °C ~ +85 °C, H: 0% ~ 95%						

Table 11 | LTE Antenna Parameter

3.3 GPS Antenna

3.3.1 Overview

The GPS antenna for Pilot Gateway Pro is shown below.



Figure 12 | GPS Antenna

3.3.2 GPS Antenna Dimensions

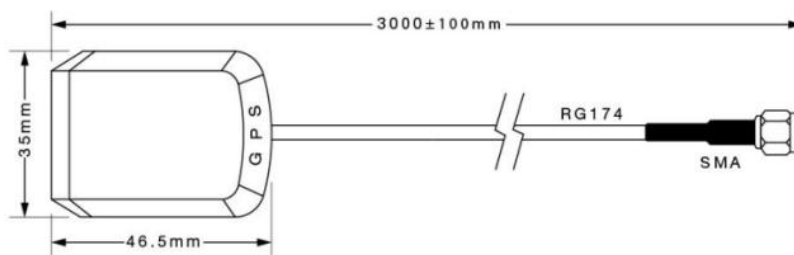

Figure 13 | GPS Antenna Dimensions

3.3.3 GPS Environmental Requirements

The antenna environmental requirements are listed in the table below:

Conditions	Temperature	Humidity
Working	-35 °C ~ +80 °C	0% ~ 95%
Storage	-40 °C ~ +85 °C	0% ~ 95%

Table 12 | GPS Environmental Requirements

3.3.4 GPS Antenna Parameter

Antenna specifications are listed in the table below:

Item	Specifications	PET
Range of Receiving Frequency	1575.42±1.1	±2.5
Center Frequency (MHz) w/ 30mm ² GND plane	1575.42	±3.0
Bandwidth (MHz) (Return Loss ≤ -10dB)	≥10	±0.5
VSWR (in Center Frequency)	≤2.0	±0.5
Gain (Zenith) (dBi Typ.) w/ 70mm ² GND Plane	4.5	±0.5
Axial Ratio (dB) w/ 70mm ² GND Plane	3.0	±0.2
Polarization	Right-Handed Circular	-
Impedance (Ω)	50	-
Frequency Temperature Coefficient (ppm/°C)	0±10	-

Table 13 | GPS Antenna Parameter

Amplifier Specifications are listed in the table below:

Item	Specifications
Frequency Range	1575.42 MHz
Gain	27 dB
VSWR	≤ 2.0 V
Noise Coefficient	≤ 2.0 dBm
DC Voltage	3 ~ 5 V
DC Current	5 ± 2 mA

Table 14 | Amplifier Specifications

Environmental test performance specifications are listed below:

Item	Normal Temp.	High Temp. ¹	Low Temp. ²
Amplifier Gain	27dB ± 2.0	27dB ± 2.0	27dB ± 2.0
VSWR	≤ 2.0	≤ 2.0	≤ 2.0
Noise Coefficient	≤ 2.0	≤ 2.0	≤ 2.0

1. High temperature test: soap in temperature (85° C) and humidity (95%) chamber for 24-hour and return to normal temperature (at least for 1-hour) without visual shape change.

2. Low temperature test: soap in temperature (-40° C) chamber for 24-hour and return to normal temperature (at least for 1-hour) without visual shape change.

Table 15 | Environmental Test Performance

4 Flash the Gateway Image

When you received your gateway, firstly you need flash the gateway image by yourself.

Please refer to the Image Start Guide for RAK7243, here is the link:

<https://www.rakwireless.com/en/download/LoRa/Pilot-Gateway-Pro-RAK7243#Application-Notes>

5 Contact Information

Shenzhen Business

 ken.yu@rakwireless.com

 Room 506, Bldg B, New Compark, Pingshan First Road, Taoyuan Street, Nanshan District, Shenzhen

Shenzhen Technical

 steven.tang@rakwireless.com

 0755-86108311

 Room 506, Bldg B, New Compark, Pingshan First Road, Taoyuan Street, Nanshan District, Shenzhen

6 Revision History

Revision	Description	Date
1.0	Initial version	2018-12-21
1.1	Update the description, some pictures and cellular antenna parameter	2019-01-15

7 Document Summary

Document Name: RAK7243 Pilot Gateway Pro User Manual
Product Name: Pilot Gateway Pro
Release Date: December 2018
Revision Number: V1.0

Prepared by	Checked by:	Approved by:
Terry & Penn	Terry	



About RAKwireless:

RAKwireless is the pioneer in providing innovative and diverse cellular and LoRa connectivity solutions for IoT edge devices. It's easy and modular design can be used in different IoT applications and accelerate time-to-market. For more information, please visit RAKwireless website at www.rakwireless.com.