

**Data sheet | Item number: 769-102/021-000**

1-conductor female connector; CAGE CLAMP®; 4 mm²; Pin spacing 5 mm; 2-pole; coding finger; Lateral locking levers; 4,00 mm²; gray

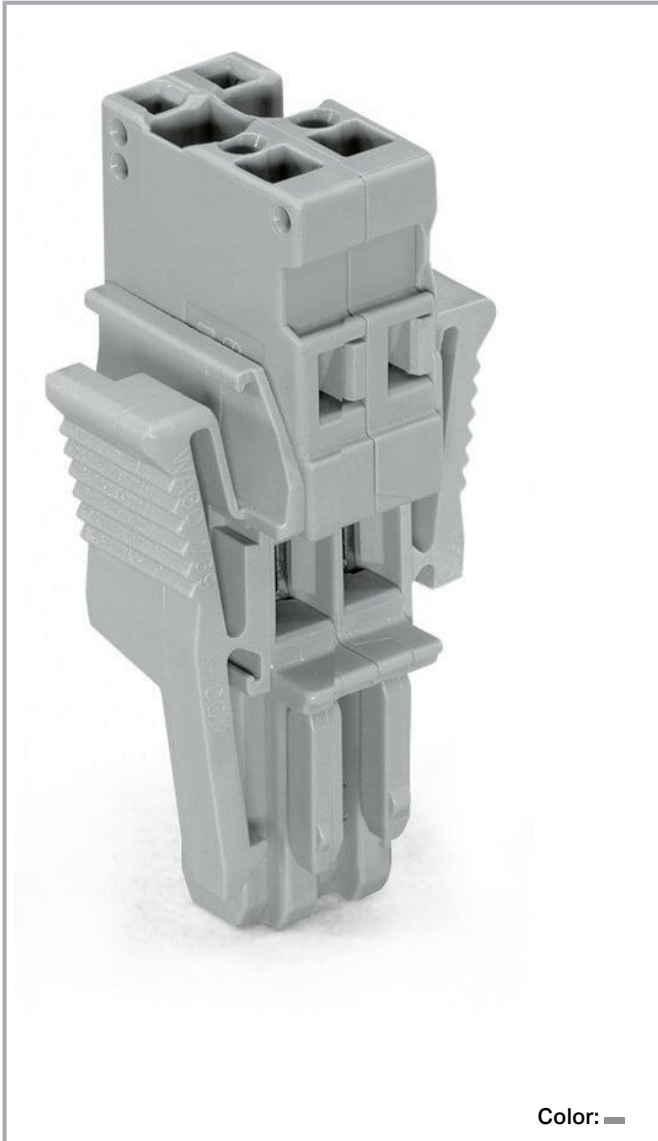

[www.wago.com/769-102/021-000](http://www.wago.com/769-102/021-000)



Color: —

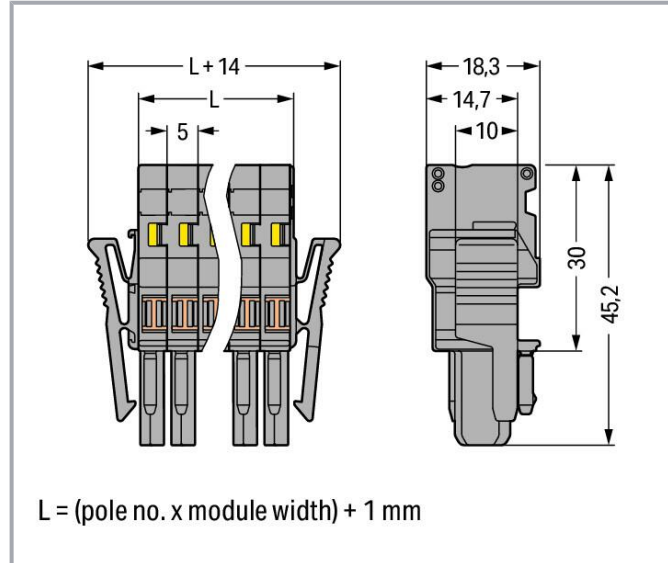

**Data  
Notes**

Safety information

According to EN 61984, pluggable connectors without current interrupting capacity must not be mated or unmated when live or

Subject to changes. Please also observe the further product documentation!

WAGO GmbH & Co. KG  
Hansastr. 27  
32423 Minden  
Phone: +49571 887-0 | Fax: +49571 887-169  
Email: [info.de@wago.com](mailto:info.de@wago.com) | Web: [www.wago.com](http://www.wago.com)

Do you have any questions about our products?  
We are always happy to take your call at +49 (571) 887-44222.



under load.

## Electrical data

### Ratings per IEC/EN

Ratings per	IEC/EN 61984
Nominal voltage (III/3)	500 V
Rated impulse voltage (III/3)	6 kV
Rated current	32 A
Legend (ratings)	(III / 3) ≙ Overvoltage category III / Pollution degree 3

### Connection data

Connection points	2
Total number of potentials	2

### Connection 1

Connection technology	CAGE CLAMP®
Actuation type	Operating tool
Connectable conductor materials	Copper
Nominal cross-section	4 mm <sup>2</sup> / 12 AWG
Solid conductor	0.08 ... 4 mm <sup>2</sup> / 28 ... 12 AWG
Fine-stranded conductor	0.08 ... 4 mm <sup>2</sup> / 28 ... 12 AWG
Strip length	8 ... 9 mm / 0.31 ... 0.35 inches
Pole number	2
Wiring direction	Front-entry wiring

### Physical data

Width	25 mm / 1.008 inches
Height	45.2 mm / 1.78 inches
Depth	18.3 mm / 0.72 inches
Module width	5 mm / 0.197 inches

### Mechanical Data

Variable coding	Yes
Direct ground contact to DIN-rail/drilled hole/housing	No
Marking level	Side marking

Subject to changes. Please also observe the further product documentation!



Anti-rotation protection	Yes
--------------------------	-----

## Plug-in connection

Contact type (pluggable connector)	Female connector/socket
Connector (connection type)	for conductor
Mismating protection	No
Plugging without loss of pin spacing	Yes
Locking lever	Yes

## Material Data

Note (material data)

Information on material specifications can be found here

Color	gray
Material group	I
Insulation material	Polyamide (PA66)
Flammability class per UL94	V0
Fire load	0.209 MJ
Halogen-free	Yes
Weight	9 g

## Environmental requirements

Processing temperature	-35 ... +85 °C
Continuous operating temperature	-60 ... +105 °C

## Commercial data

Product Group	18 (X-COM-System)
eCl@ss 10.0	27-14-11-06
eCl@ss 9.0	27-14-11-06
ETIM 8.0	EC001284
ETIM 7.0	EC001284
PU (SPU)	50 pcs
Packaging type	box
Country of origin	DE
GTIN	4044918480697
Customs tariff number	85366990990

Subject to changes. Please also observe the further product documentation!

WAGO GmbH & Co. KG  
 Hansastr. 27  
 32423 Minden  
 Phone: +49571 887-0 | Fax: +49571 887-169  
 Email: [info.de@wago.com](mailto:info.de@wago.com) | Web: [www.wago.com](http://www.wago.com)

Do you have any questions about our products?  
 We are always happy to take your call at +49 (571) 887-44222.

## Environmental Product Compliance

RoHS Compliance Status

Compliant, No Exemption

## Approvals / Certificates

### General approvals

Logo	Approval	Additional Approval Text	Certificate name
	CCA DEKRA Certification B.V.	EN 60947	NTR NL-7626
	CCA DEKRA Certification B.V.	EN 61984	2190419.02
	CCA DEKRA Certification B.V.	IEC 61984	NL-47799 /A1
	CSA DEKRA Certification B.V.	C22.2 No. 158	1101144
	KEMA/KEUR DEKRA Certification B.V.	EN 60947	2190419.01
	UL Underwriters Laboratories Inc.	UL 1977	E 45171
	UR Underwriters Laboratories Inc.	UL 1059	E45172

### Declarations of conformity and manufacturer's declarations



Logo	Approval	Additional Approval Text	Certificate name
	EU-Declaration of Conformity WAGO GmbH & Co. KG	-	-
	UK-Declaration of Conformity	-	-

Subject to changes. Please also observe the further product documentation!









WAGO GmbH &amp; Co. KG

## Approvals for marine applications

Logo	Approval	Additional Approval Text	Certificate name
	<b>ABS</b> American Bureau of Shipping	EN 60947	20- HG1941090- PDA
	<b>DNV GL</b> Det Norske Veritas, Germanischer Lloyd	-	TAE00001V2

## Optional accessories

## Ferrule

Ferrule		
	<b>Item no.: 216-101</b> Ferrule; Sleeve for 0.5 mm <sup>2</sup> / AWG 22; uninsulated; electro-tin plated; silver-colored	<a href="http://www.wago.com/216-101">www.wago.com/216-101</a>
	<b>Item no.: 216-104</b> Ferrule; Sleeve for 1.5 mm <sup>2</sup> / AWG 16; uninsulated; electro-tin plated; silver-colored	<a href="http://www.wago.com/216-104">www.wago.com/216-104</a>
	<b>Item no.: 216-102</b> Ferrule; Sleeve for 0.75 mm <sup>2</sup> / AWG 20; uninsulated; electro-tin plated; silver-colored	<a href="http://www.wago.com/216-102">www.wago.com/216-102</a>
	<b>Item no.: 216-103</b> Ferrule; Sleeve for 1 mm <sup>2</sup> / AWG 18; uninsulated; electro-tin plated	<a href="http://www.wago.com/216-103">www.wago.com/216-103</a>
	<b>Item no.: 216-203</b> Ferrule; Sleeve for 1 mm <sup>2</sup> / AWG 18; insulated; electro-tin plated; red	<a href="http://www.wago.com/216-203">www.wago.com/216-203</a>
	<b>Item no.: 216-206</b> Ferrule; Sleeve for 2.5 mm <sup>2</sup> / AWG 14; insulated; electro-tin plated; blue	<a href="http://www.wago.com/216-206">www.wago.com/216-206</a>
	<b>Item no.: 216-202</b> Ferrule; Sleeve for 0.75 mm <sup>2</sup> / 18 AWG; insulated; electro-tin plated; gray	<a href="http://www.wago.com/216-202">www.wago.com/216-202</a>
	<b>Item no.: 216-204</b> Ferrule; Sleeve for 1.5 mm <sup>2</sup> / AWG 16; insulated; electro-tin plated; black	<a href="http://www.wago.com/216-204">www.wago.com/216-204</a>
	<b>Item no.: 216-201</b> Ferrule; Sleeve for 0.5 mm <sup>2</sup> / 20 AWG; insulated; electro-tin plated; white	<a href="http://www.wago.com/216-201">www.wago.com/216-201</a>
	<b>Item no.: 216-301</b>	

Subject to changes. Please also observe the further product documentation!

WAGO GmbH &amp; Co. KG

Hansastr. 27

32423 Minden

Phone: +49571 887-0 | Fax: +49571 887-169

Email: [info.de@wago.com](mailto:info.de@wago.com) | Web: [www.wago.com](http://www.wago.com)

Do you have any questions about our products?

We are always happy to take your call at +49 (571) 887-44222.

Ferrule; Sleeve for 0.25 mm<sup>2</sup> / AWG 24; insulated; electro-tin plated; yellow

[www.wago.com/216-301](http://www.wago.com/216-301)

**Item no.: 216-302**

Ferrule; Sleeve for 0.34 mm<sup>2</sup> / 22 AWG; insulated; electro-tin plated; light turquoise

[www.wago.com/216-302](http://www.wago.com/216-302)

### Insulation stop

Insulation stop



**Item no.: 769-470**

Insulation stop; 0.08 - 0.2 mm<sup>2</sup> "s" (0.14 mm<sup>2</sup> "f-st"); 5 pieces/strip; white

[www.wago.com/769-470](http://www.wago.com/769-470)



**Item no.: 769-471**

Insulation stop; 0.25 - 0.5 mm<sup>2</sup>; 5 pieces/strip; light gray

[www.wago.com/769-471](http://www.wago.com/769-471)



**Item no.: 769-472**

Insulation stop; 0.75 - 1 mm<sup>2</sup>; 5 pieces/strip; dark gray

[www.wago.com/769-472](http://www.wago.com/769-472)

### Cover

Cover



**Item no.: 769-436**

Jumper cover; for 1-conductor female plugs; for 5 poles; gray

[www.wago.com/769-436](http://www.wago.com/769-436)

### Locking levers

Locking system



**Item no.: 769-430**

Locking lever; for female connectors; 1 part; Pin spacing 5 mm; 2-pole; gray

[www.wago.com/769-430](http://www.wago.com/769-430)



**Item no.: 769-431**

Locking lever; for female connectors; 1 part; Pin spacing 5 mm; 2-pole; orange

[www.wago.com/769-431](http://www.wago.com/769-431)

### Strain relief

Strain relief



**Item no.: 769-1602**

Strain relief housing; for female and male connectors; 2 parts; Pin spacing 5 mm; 2-pole; gray

[www.wago.com/769-1602](http://www.wago.com/769-1602)



**Item no.: 769-411**

Strain relief plate; for female and male connectors; 1 part; Pin spacing 5 mm; 2- to 3-pole; gray

[www.wago.com/769-411](http://www.wago.com/769-411)

### Tool

Operating tool



**Item no.: 210-490**

Operating tool

[www.wago.com/210-490](http://www.wago.com/210-490)



**Item no.: 769-434**

Operating tool; made of insulating material; 1-way; loose; white

[www.wago.com/769-434](http://www.wago.com/769-434)

Subject to changes. Please also observe the further product documentation!

WAGO GmbH & Co. KG

Hansastr. 27

32423 Minden

Phone: +49571 887-0 | Fax: +49571 887-169



Email: [info.de@wago.com](mailto:info.de@wago.com) | Web: [www.wago.com](http://www.wago.com)

Do you have any questions about our products?

We are always happy to take your call at +49 (571) 887-44222.

## Marking accessories



### Marking strip

	<b>Item no.: 210-831</b> Marking strips; on reel; 2.3 mm wide; plain; Self-adhesive; white	<a href="http://www.wago.com/210-831">www.wago.com/210-831</a>
	<b>Item no.: 210-834</b> Marking strips; on reel; 5 mm wide; plain; Self-adhesive; white	<a href="http://www.wago.com/210-834">www.wago.com/210-834</a>
	<b>Item no.: 210-832</b> Marking strips; on reel; 3 mm wide; plain; Self-adhesive; white	<a href="http://www.wago.com/210-832">www.wago.com/210-832</a>

### Label

	<b>Item no.: 210-805</b> Labels; for Smart Printer; permanent adhesive; 6 x 15 mm; white	<a href="http://www.wago.com/210-805">www.wago.com/210-805</a>
	<b>Item no.: 210-805/000-002</b> Labels; for Smart Printer; permanent adhesive; 6 x 15 mm; yellow	<a href="http://www.wago.com/210-805/000-002">www.wago.com/210-805/000-002</a>

### Marker

	<b>Item no.: 2009-145</b> Mini-WSB Inline; for Smart Printer; 1700 pieces on roll; stretchable 5 - 5.2 mm; plain; snap-on type; white	<a href="http://www.wago.com/2009-145">www.wago.com/2009-145</a>
	<b>Item no.: 248-501</b> Mini-WSB marking card; as card; not stretchable; plain; snap-on type; white	<a href="http://www.wago.com/248-501">www.wago.com/248-501</a>

## Testing and measuring

### Testing accessories

	<b>Item no.: 210-136</b> Test plug; 2 mm Ø; with 500 mm cable; red	<a href="http://www.wago.com/210-136">www.wago.com/210-136</a>
------------------------------------------------------------------------------------	-----------------------------------------------------------------------	----------------------------------------------------------------

## Protective warning marker

### Cover

	<b>Item no.: 280-415</b> Protective warning marker; for 5 terminal blocks; with high-voltage symbol, black; yellow	<a href="http://www.wago.com/280-415">www.wago.com/280-415</a>
------------------------------------------------------------------------------------	-----------------------------------------------------------------------------------------------------------------------	----------------------------------------------------------------

## Jumpers

### Jumper

	<b>Item no.: 769-402</b> Jumper; insulated; gray	<a href="http://www.wago.com/769-402">www.wago.com/769-402</a>
-----------------------------------------------------------------------------------	-----------------------------------------------------	----------------------------------------------------------------

Subject to changes. Please also observe the further product documentation!



## Downloads

### Documentation

#### Bid Text

769-102/021-000 X81 - Datei	2019 Feb 19	xml 3.3 kB	Download
--------------------------------	-------------	---------------	----------

769-102/021-000 doc - Datei	2017 Oct 4	doc 25.6 kB	Download
--------------------------------	------------	----------------	----------

#### Additional Information

Technical Section Technical explanations		pdf 2.2 MB	Download
---------------------------------------------	--	---------------	----------

## CAD/CAE-Data

### CAD data

2D/3D Models 769-102/021-000		URL	Download
------------------------------	--	-----	----------

### CAE data

EPLAN Data Portal 769-102/021-000		URL	Download
-----------------------------------	--	-----	----------

WSCAD Universe 769-102/021-000		URL	Download
--------------------------------	--	-----	----------

ZUKEN Portal 769-102/021-000		URL	Download
------------------------------	--	-----	----------

WSCAD Universe 769-102/021-000		URL	Download
--------------------------------	--	-----	----------

EPLAN Data Portal 769-102/021-000		URL	Download
-----------------------------------	--	-----	----------

## Environmental Product Compliance

### Compliance Search

Environmental Product Compliance 769-102/021-000 1-conductor female connector; CAGE CLAMP®; 4 mm <sup>2</sup> ; Pin spacing 5 mm; 2-pole; coding finger; Lateral locking levers; 4,00 mm <sup>2</sup> ; gray		URL	Download
--------------------------------------------------------------------------------------------------------------------------------------------------------------------------------------------------------------------	--	-----	----------

Subject to changes. Please also observe the further product documentation!



## Installation Notes

### Conductor termination

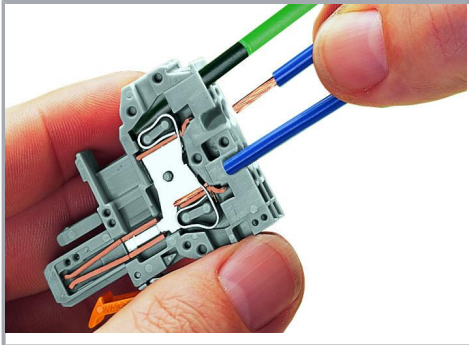

### CAGE CLAMP® connection

Female plug: Inserting/removing a conductor via operating tool.

Operation 90° to conductor is also possible.

With ferruled conductors, it is necessary to use a terminal block one size smaller than the conductor's nominal cross-section.

### Commoning

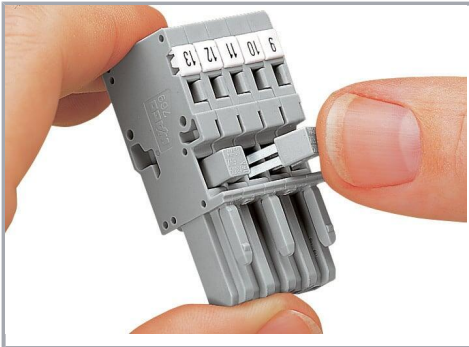

Commoning 1-conductor female plugs via miniature adjacent jumpers.

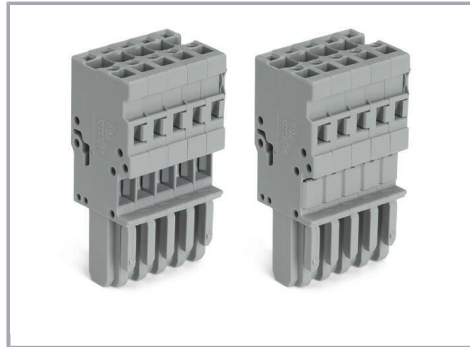

Jumper cover for 1-conductor female plugs

### Coding

Subject to changes. Please also observe the further product documentation!



Coding a female plug by removing coding finger(s) via cutting tool. Do not remove the first and last coding fingers or use an additional locking lever.

#### Locking system

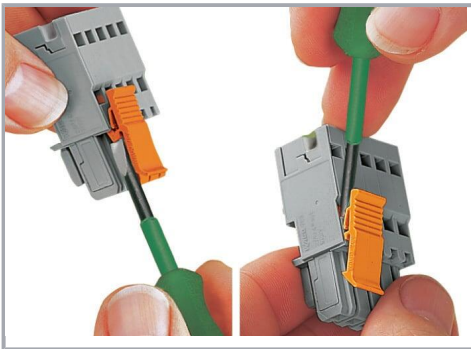

Locking/releasing a lever.

#### Strain relief

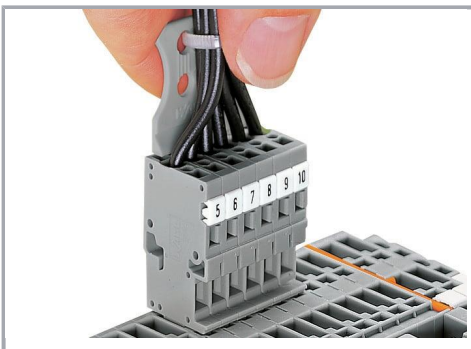

Removing a female plug via conductor bundle provided with strain relief plate.

Subject to changes. Please also observe the further product documentation!

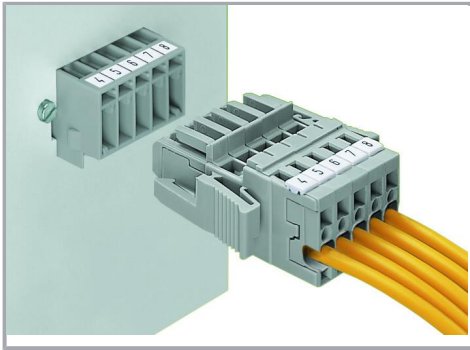

Male header with mounting flanges

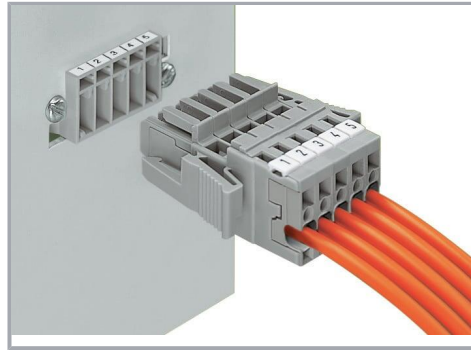

Male header and 1-conductor female plug with lateral locking levers

1-conductor female plug with lateral locking levers

### Marking

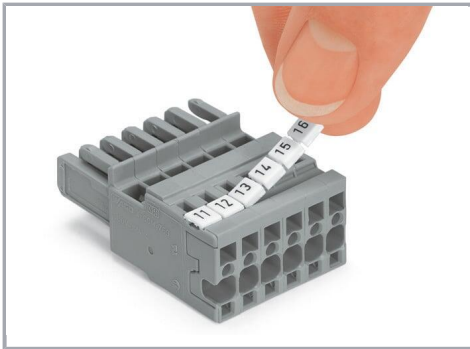

Labeling a female plug with CAGE CLAMP® connection via Mini-WSB Quick Markers.

### Product family

X-COM

[Show all products from the family](#)

Subject to changes. Please also observe the further product documentation!