

REMOTE HYDRAULIC COMPRESSION TOOLS

© Panduit Corp. 2018

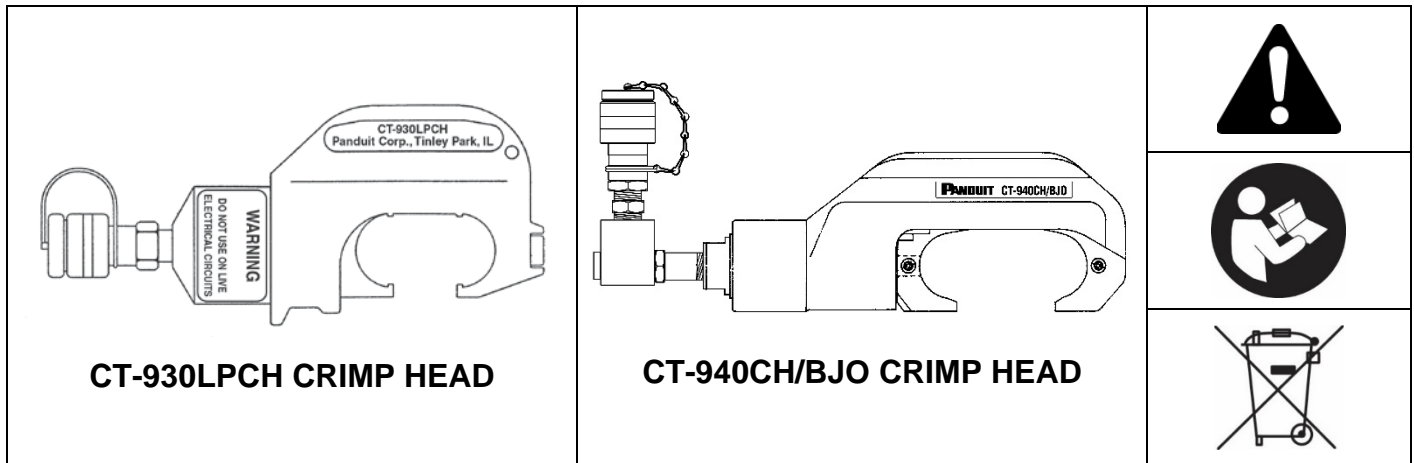



Table of Contents

SYSTEM SPECIFICATIONS.....	1
OPTIONAL ACCESSORIES (<i>sold separately</i>)	1
PRECAUTIONS AND GENERAL GUIDELINES.....	3
DIE SELECTION.....	5
DIE IDENTIFICATION FOR USE WITH MATCHED COMPRESSION CONNECTOR.....	5
DIE INSTALLATION.....	6
TOOL OPERATION (<i>see Figures 3 and 4 above</i>)	7
MAINTENANCE	8
PERIODIC MAINTENANCE	8
CLEANING AND LUBRICATION OF TOOL HEAD.....	8
VISUAL INSPECTION	8
FORCE INSPECTION / CALIBRATION.....	9
CONTACT INFORMATION	9

	 <p>WARNING: Read all safety warnings, instructions, illustrations and specifications provided with this power tool. Failure to follow all instructions listed below may result in electric shock, fire and/or serious injury. Save all warnings and instructions for future reference.</p>
---	--

<p>Email: techsupport@panduit.com</p>	 <p>www.panduit.com</p>	<p>Panduit Corp. • Tinley Park, IL USA Technical Support Tel: 1-800-777-3300</p>
<p>EU Website: www.panduit.com/emea</p> <p>EU Email: emeatoolservicecenter@panduit.com</p>		<p>Panduit Europe • EMEA Service Center Almelo, Netherlands Tel: +31 546 580 452 • Fax: +31 546 580 441</p>

SYSTEM SPECIFICATIONS

CT-930LPCH Hydraulic Crimping Tool	Output:	7.7 Tons / (7.0 metric tons)
	Input:	5,000 PSI / (350 bar) hydraulic pressure provided by a separate hydraulic pump system (Panduit CT-902HP-5K Hydraulic Pump and CT-900LPHPH 10-foot Hydraulic Hose).
	Dimensions:	12-3/4" L x 5" H x 3" W 324 L x 124 H x 76 W (mm)
	Weight:	11 lbs. / (5 kg)
	Hydraulic Fittings:	Parker-Hannifin 3/8" Male Quick Coupler
Carrying Case:	Included with CT-930LPCH Tool	

CT-940CH/BJO Hydraulic Crimping Tool	Output:	15.0 tons / (13.6 metric tons)
	Input:	10,000 PSI / (700 bar) hydraulic pressure provided by a separate hydraulic pump system (Panduit CT-902HP Hydraulic Pump and CT-900HPH 10 foot Hydraulic Hose).
	Dimensions:	14.5" L x 4.1" H x 2.5" W 386 L x 104 H x 64 W (mm)
	Weight:	14.5 lbs. / (4.8 kg)
	Hydraulic Fittings:	BJO model has 90° swivel Parker-Hannifin 3/8" Female Quick Coupler
Carrying Case:	Included with CT-940CH Tool	

NOTE: CONNECTIONS UTILIZING THIS TOOL ARE U.L. LISTED AND C.S.A. CERTIFIED ONLY WHEN PANDUIT COMPRESSION CONNECTORS ARE USED. USE OF ANY OTHER BRAND OF COMPRESSION CONNECTORS IS NOT RECOMMENDED.

Consult product packaging, Panduit catalog or website for information on recommended compression connectors.



OPTIONAL ACCESSORIES (sold separately)











Compression Dies - for CT-930LPCH, or CT-940CH/BJO:	Refer to Panduit catalog or Sales Office for part numbers and specific die application information.
CD-940-DA Die Adapter:	To be used with CD-920 and CD-930 series dies
CG-920 Compression Gauge:	Verifies the compression force of the CT-930LPCH tool.
CG-940 Compression Gauge:	Verifies the compression force of the CT-940CH/BJO tool.



CT-900HPH or CT-900LPHPH:	Electrically non-conductive 10 ft. hose. Supplied pre-filled with hydraulic fluid for fast start up.
Hydraulic Pump System – for the CT-940CH/BJO:	CT-902HP Hydraulic Pump System is factory preset at 10,000-PSI \pm 200 PSI (700 bar). Pump shuts off when cycle is complete. Will not release until the down switch is activated.
Hydraulic Pump System – for the CT-930LPCH:	CT-902HP-5K Hydraulic Pump System is factory preset at 5,000-PSI \pm 200 PSI (350 bar). Pump shuts off when cycle is complete. Will not release until the down switch is activated.
CT-902RCH Remote Control Handle	To ease operation of the Hydraulic Tool System Dimensions: 155 L x 167 H x 34 W (mm) 6.1 L x 6.6 H x 1.4 W in. Weight: 3.0 (kg) / 6.6 lbs.
CT-902RFS Remote Foot Switch	Remote Foot Switch allows for hands free operation Dimensions: 243 L x 173 H x 180 W (mm) 9.6 L x 6.8 H x 7.1 W in. Weight: 3.5 (kg) / 7.7 lbs.
CT-940CHHAN	Handle can be mounted to crimp head for ease in movement when performing multiple crimps.
PG-1	Verifies the PSI reading of the CT-902HP Hydraulic Pump and CT-902HP-5K Low Pressure Hydraulic Pump.

The information contained in this literature is based on our experience to date and is believed to be reliable. It is intended as a guide for use by persons having technical skill at their own discretion and risk. We do not guarantee favorable results or assume any liability in connection with its use. Dimensions contained herein are for reference purposes only. For specific dimensional requirements consult the factory. This publication is not to be taken as a license to operate under, or a recommendation to infringe any existing patents. This supersedes and voids all previous literature, etc.

PRECAUTIONS AND GENERAL GUIDELINES

	This symbol is used to call your attention to hazards or unsafe practices which could result in an injury or property damage. The signal word, defined below, indicates the severity of the hazard. The message after the signal word provides information for preventing or avoiding the hazard.	
	WARNING	Hazards which, if not avoided, COULD result in severe injury or death.
	CAUTION	Hazards or unsafe practices which, if not avoided, MAY result in injury or property damage.

	WARNING: When performing any service on this pump or any of its' components, the unit MUST be disconnected from the power supply outlet.	
	 WARNING	Read and understand all of the instructions and safety information in this manual before operating or servicing this tool.
	 WARNING	Electric Shock Hazard: This tool is not insulated. When using this unit on or near energized electrical lines, use proper personal protective equipment.
	 WARNING	Wear eye protection when operating or servicing this tool. Failure to wear eye protection can result in serious eye injury from flying debris or hydraulic oil.
	 WARNING	Skin Injection Hazard: Oil under pressure easily punctures skin causing serious injury, gangrene, or death. If you are injured by escaping oil, seek medical attention immediately. <ul style="list-style-type: none"> • Do not use hands to check for leaks. • Depressurize the hydraulic system before servicing.
	 WARNING	Keep hands away from the tool head when crimping.

	<p>WARNING</p> <p>Do not use solvents or flammable liquids to clean this tool. Solvents or flammable liquids could ignite and cause serious injury or property damage.</p> <p>Do not use tool in or near a highly flammable or explosive atmosphere and/or materials.</p>
	<p>CAUTION: Ear protection should be worn when operating the tool.</p>
<p>CAUTION – When using CT-930LPCH or CT-940CH/BJO Crimp Heads</p> <p>DO NOT OPERATE WITHOUT DIES</p>	
<p>WARNING</p>	
<ul style="list-style-type: none"> • An incomplete crimp can cause a fire. • Use proper compression connector and cable combinations. Improper combinations can result in an incomplete crimp. • The relief valve will sound to indicate a completed crimp. If you do not hear the sound of the relief valve, the crimp is not complete. • Inspect tool before use. A worn or damaged tool may result in breakage striking the operator or nearby personnel. • Do not lift crimp head by pulling hydraulic hose assembly. If tool is to be moved frequently, the CT-940CHHAN Tool Handle assembly (sold separately) should be used to avoid damage to hydraulic hose assembly. 	
<p>CAUTION</p>	
<ul style="list-style-type: none"> • Do not perform any service or maintenance other than as described in this manual. Injury or damage to the tool may result. • Do not place the tool in a vise. The tool is designed for hand-held operation. • Protect the tool from rain and moisture. • Use this tool for the manufacturer’s intended purpose only. 	



IMPORTANT INFORMATION

- Keep the tool head portion clean and free from debris. Excessive dirt and grit can contribute to the premature wear of the tool's internal mechanical parts. When not using the tool, regularly check that no foreign matter or debris exists in the open areas between the indenters in the tool head.
- Soap and a damp cloth should be used to clean the tool body.
- Always store the tool in its clean, dry carrying case when not in use.
- **DO NOT** press trigger and release button simultaneously. Damage to trigger linkage may result.
- Always point tool away from others.
- If the tool is kept in cold temperatures below 23°F/-5°C for any extended time, it is advisable to return the tool to room temperature for 1 hour before using.
- Avoid dropping the tool. Extreme shock may damage the hydraulic circuit and result in malfunction of the tool.
- Always verify the proper size compression connector for the conductor, by checking the color code and the printing on the compression connector.

DIE SELECTION

Match index number and color on die (see Figures 1 and 2 on Page 5 and Page 6) to index number and color band on compression connector.

NOTE: CONNECTIONS UTILIZING THIS TOOL ARE U.L. LISTED AND C.S.A. CERTIFIED ONLY WHEN PANDUIT COMPRESSION CONNECTORS ARE USED. USE OF ANY OTHER BRAND OF COMPRESSION CONNECTORS IS NOT RECOMMENDED.

Consult product packaging, Panduit catalog or website for information on recommended compression connectors.

DIE IDENTIFICATION FOR USE WITH MATCHED COMPRESSION CONNECTOR

1. Always verify correct die set by die part number.
2. Color coding dot for verification may be found near die crimp pocket.

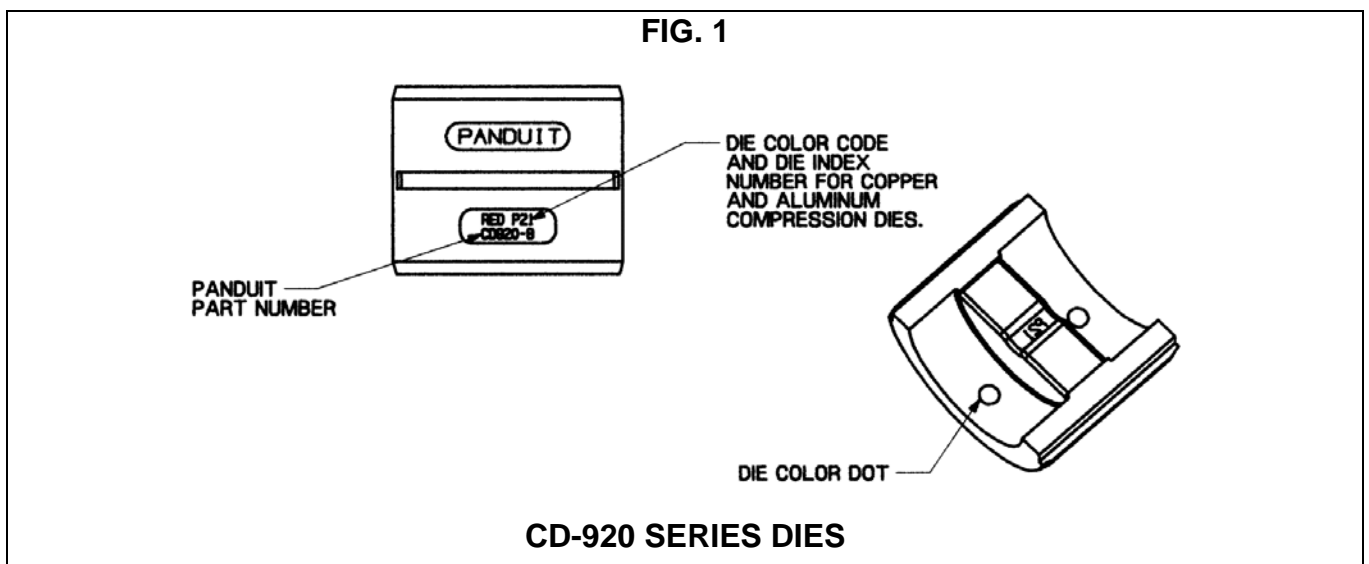

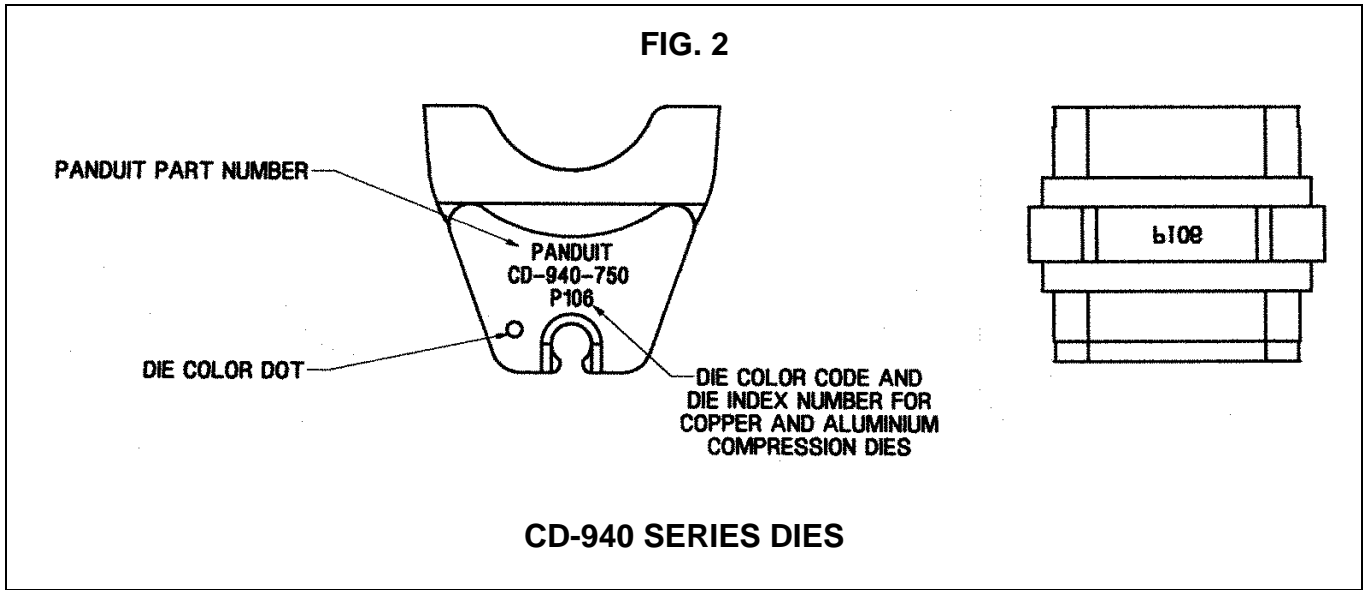

DIE INSTALLATION



CAUTION: DO NOT operate tool without dies installed.

1. Select the appropriate dies to match the compression connector to be crimped.
2. Align one of the die halves in the die cavity contour in the tool head or ram. While depressing the die release buttons, slide the die half so it is seated in the die cavity. Release the die release buttons and check to ensure the die is locked into place. Repeat procedure with second die half.

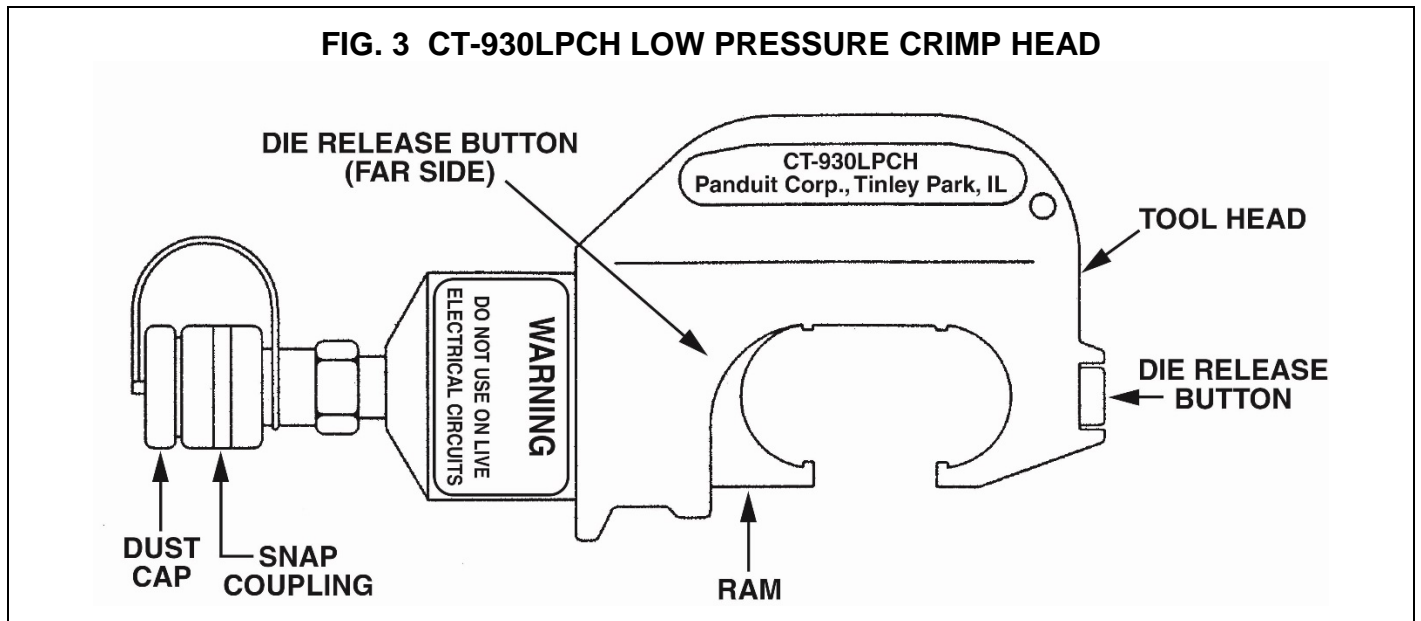

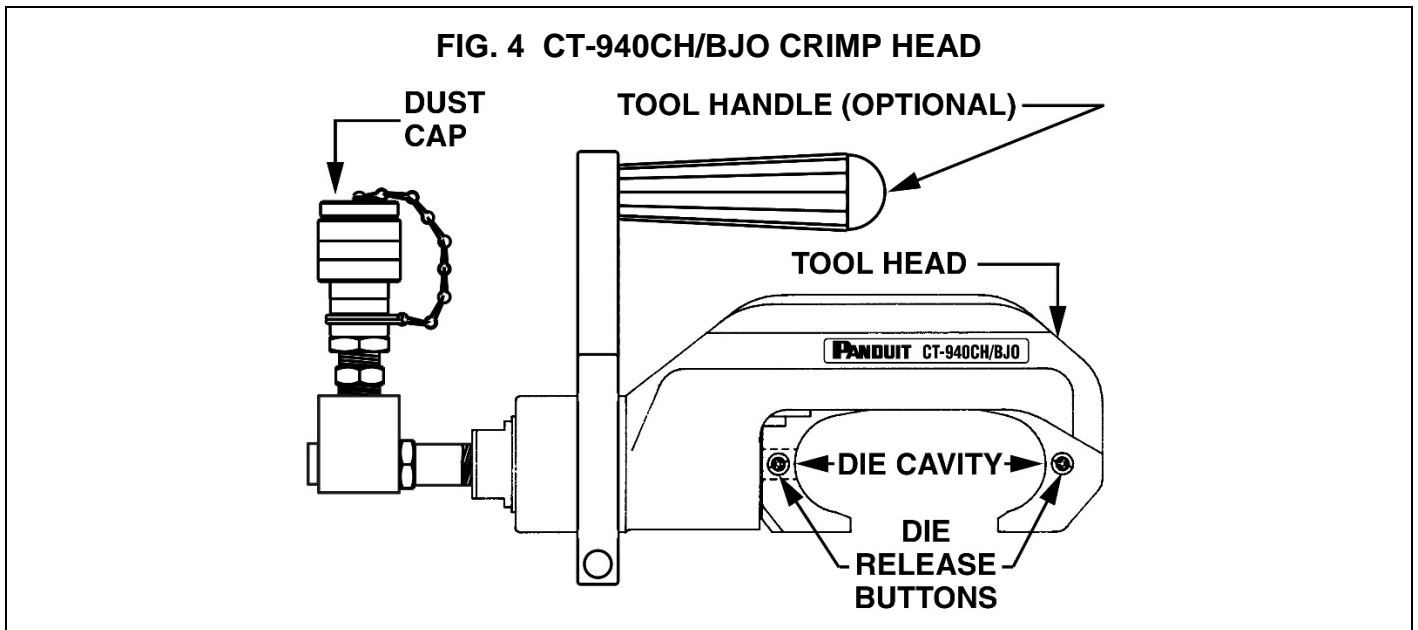

NOTE: The optional tool handle (CT-940CHHAN) is recommended for ease in carrying when the crimp head is being moved frequently.

TOOL OPERATION (see Figures 3 and 4 above)

1. The CT-940CH/BJO Tool Head must be operated with a compatible hydraulic pump system, capable of developing and sustaining 10,000 PSI. The Panduit CT-902HP Hydraulic Pump and CT-900HPH High Pressure Hose (electrically non-conductive; 10 foot long) are recommended. This system's fittings are matched to the tool head fittings

The CT-930LPCH Tool Head must be operated with a compatible hydraulic pump system, capable of developing and sustaining 5,000 PSI. The Panduit CT-902HP-5K Hydraulic Pump and CT-900LPHPH Low Pressure Hose (electrically non-conductive; 10 foot long) are recommended. This system's fittings are matched to the tool head fittings.

2. The CT-930LPCH and CT-940CH/BJO Tool Heads have been charged with hydraulic fluid at the factory. Remove the dust cap from the connector coupling on the tool.



CAUTION: Upon removing the dust cap, be sure to keep the hydraulic fittings on the tool head, hydraulic pump and hydraulic hose free from contaminants. Failure to do so may lead to malfunction of the tool head and/or hydraulic pump.

3. Connect the coupling of the tool head onto the coupling of the hydraulic hose.
4. Refer to the operation manual provided with your particular hydraulic pump system for the specific set-up operation, and maintenance of the hydraulic pump. Verify that the open areas between the ram and tool head are free of foreign matter and debris that could jam or damage the tool during operation. Cycle the tool head 2 or 3 times by activating the hydraulic pump. Be sure dies are in the tool head prior to cycling the tool. Check for leaks at all connections.
5. Carefully place the compression connector between the dies so that the dies will crimp between the color bands on the compression connector. Activate the pump to advance the ram until the compression connector is held by the dies.



CAUTION: DO NOT crimp the compression connector at this time.

6. Verify that the conductor size and dies properly match the compression connector size being used. Insert the conductor completely into the compression connector barrel.
7. Begin crimping by activating the hydraulic system. The Panduit CT-902HP and CT-902HP-5K Hydraulic Pumps incorporate a by-pass valve which, when activated, shuts off the pump when the crimp is completed.
8. Deactivate the hydraulic system to retract the ram for removal or repositioning of the compression connector/conductor assembly.

MAINTENANCE

PERIODIC MAINTENANCE

1. Daily maintenance is important to keep the tool in good working condition. Keep the head clean and free of debris. Excessive dirt and grit can contribute to the premature wear of the tool's mechanical parts. Always replace the dust cap on the connector fitting, and store the tool in its clean, dry carrying case when not in use.
2. Particular attention should be made in keeping the tool head openings free of foreign matter and debris. When using the tool regularly, check that no foreign matter or debris exists in the open areas between the ram and tool head. Thoroughly clean and lubricate the tool head. A tool that is dirty with excessive foreign matter may jam and become damaged during operation.
3. The hydraulic system has been calibrated and sealed at the factory. Contact Technical Support if hydraulic problems are experienced.
4. As long as the daily maintenance procedures are adequately carried out, the tool will provide quality service for years. However, if problems are experienced, please contact our Technical Support at 1-800-777-3300.

CLEANING AND LUBRICATION OF TOOL HEAD

Thorough cleaning and lubrication of the tool head is recommended annually, depending on usage. It is recommended that the CT-930LPCH or CT-940CH/BJO Tools be returned to Panduit Global Service Center for proper maintenance by our trained service staff.

VISUAL INSPECTION

1. Visually inspect tool for cracks or damage that may affect tool performance.
2. Visually inspect indenters for cracks, chips or damaged surfaces.
3. Visually inspect tool for loose or missing components and evidence of loss of hydraulic fluid.
4. If tool is damaged, or if parts are missing, contact Technical Support.

FORCE INSPECTION / CALIBRATION

Inspect the compression force of the crimp head monthly, whenever possible damage has occurred, or as often as operating conditions warrant.

The tool output force can be certified by using a Panduit Compression Gauge, CG-920 or CG-940 (purchased separately, see *Optional Accessories on Page 1*), or return tool to Panduit Global Service Center for maintenance and calibration.

CONTACT INFORMATION

Panduit Global Service Center (USA) 16530 W. 163 rd Street Lockport, IL 60441 Technical Support: 1-800-777-3300	Panduit EMEA Service Center (EUR) EMEA Tool Service Center Bedrijvenpark Twente 360 7602 KL Almelo tel + 31 546 580 451
--	---