

# APPROVAL SHEET

**WLFM160808\_P**

**WLFM201209\_P**

**WLFM201205\_P**

**WLFM201609\_P**

**Multi-Layer Power Inductor**



\*Contents in this sheet are subject to change without prior notice.

## Features

1. General purpose chip ferrite power inductor for high integration electronics device.
2. Ceramic structure provides high reliability · high productivity.
3. Low DC resistance with high current.
4. RoHS compliance.

## Applications

1. DC line filter, DC/DC inductor.
2. Suitable for DVD,DSC,PND,PC,NB,Power Line.

## Shape and Dimension

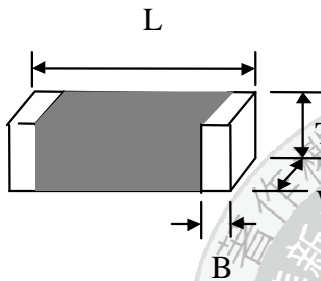

Unit: mm (inches)

WLFM Series	L	W	T	B (Min/Max)
WLFM160808*P	1.6±0.15	0.8±0.15	0.8±0.15	0.3±0.2
WLFM201209*P	2.0±0.15	1.25±0.15	0.9±0.1	0.5±0.2
WLFM201205*P	2.0±0.15	1.25±0.15	0.5±0.05	0.5±0.2
WLFM201609*P	2.0±0.15	1.60±0.15	0.9±0.1	0.5±0.2

## Ordering Information

WL	FM	1608	08	M	R47	P	P
Product Code	Series	Dimensions	Thickness	Tolerance	Value	Packing Code	P
WL: Inductor	Multilayer	1608:EIA 0603 2012:EIA 0805 2016:EIA 0806	05 = 0.5mm 08 = 0.8mm 09= 0.9mm	M: ± 20%	R47=0.47uH 2R2=2.2uH	P=7" Reeled (Embossed tape)	P=General

## Electrical Characteristics

### ● WLFM160808 series (EIA 0603)

Walsin Part Number	L(uH) Inductance	Tolerance	Measuring Frequency (MHz)	RDC DC Resistance (Ω) Max.	Rated Current (mA)	SRF (MHz)
WLFM160808MR24PP	0.24	M	1	0.1	1200	90
WLFM160808MR47PP	0.47	M	1	0.1	1200	70
WLFM160808M1R0PP	1.0	M	1	0.2	950	60
WLFM160808M2R2PP	2.2	M	1	0.3	750	50

### ● WLFM201209 series (EIA 0805)

Walsin Part Number	L(uH) Inductance	Tolerance	Measuring Frequency (MHz)	RDC DC Resistance (Ω) Max.	Rated Current (mA)	SRF (MHz)
WLFM201209MR47PP	0.47	M	1	0.08	1300	100
WLFM201209M1R0PP	1.0	M	1	0.1	900	50
WLFM201209M2R2PP	2.2	M	1	0.23	800	40
WLFM201209M4R7PP	4.7	M	1	0.23	800	40

### ● WLFM201205 series (EIA 0805)

Walsin Part Number	L(uH) Inductance	Tolerance	Measuring Frequency (MHz)	RDC DC Resistance (Ω) Max.	Rated Current (mA)	SRF (MHz)
WLFM201205MR47PP	0.47	M	1	0.12	1100	100
WLFM201205M1R0PP	1.0	M	1	0.19	800	90
WLFM201205M1R5PP	1.5	M	1	0.26	700	70
WLFM201205M2R2PP	2.2	M	1	0.33	600	40

### ● WLFM201609 series (EIA 0806)

Walsin Part Number	L(uH) Inductance	Tolerance	Measuring Frequency (MHz)	RDC (Ω) Max.	Rated Current (mA)	SRF (MHz)
WLFM201609MR47PP	0.47	M	1	0.06	1600	80
WLFM201609M1R0PP	1.0	M	1	0.09	1400	70
WLFM201609M1R5PP	1.5	M	1	0.11	1200	50
WLFM201609M2R2PP	2.2	M	1	0.11	1200	50
WLFM201609M4R7PP	4.7	M	1	0.14	1100	20

### TEST INSTRUMENT :

- HP4291B-RF Impedance / Material Analyzer
  - HP4338A/B Milliohm meter
- Test Frequency : 1MHz / OSC Level : 100mV

## Current Characteristic

### Inductance @ Frequency

**160808 Series**

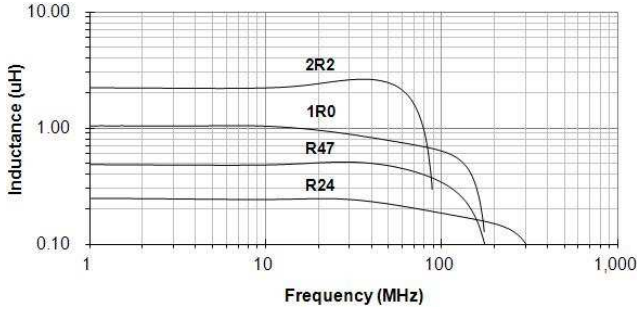

**201209 Series**

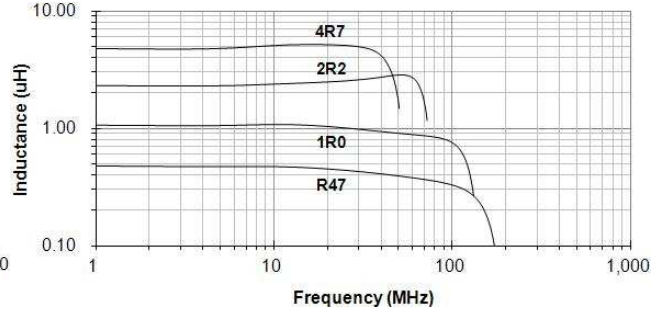

**201609 Series**

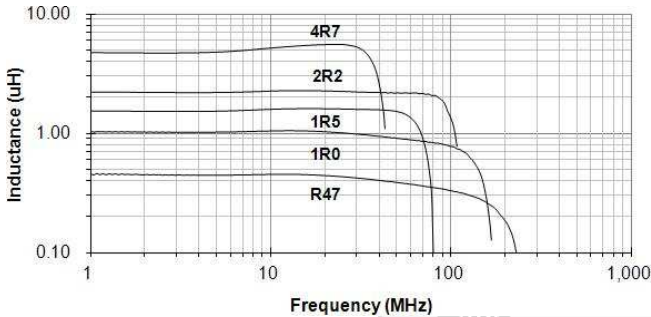

**201205 Series**

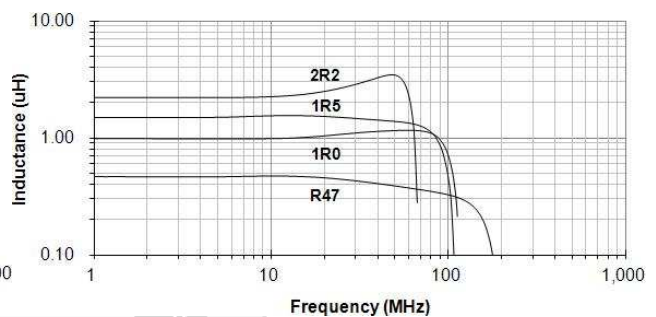

### Inductance vs DC-bias

**160808 Series**

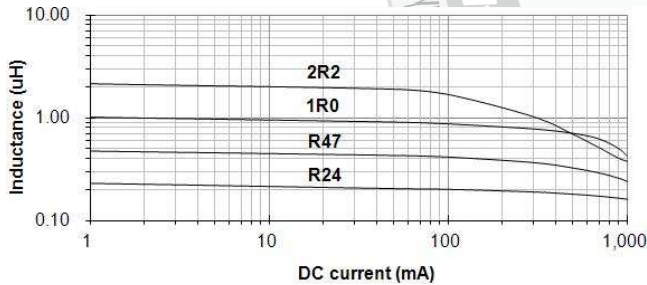

**201209 Series**

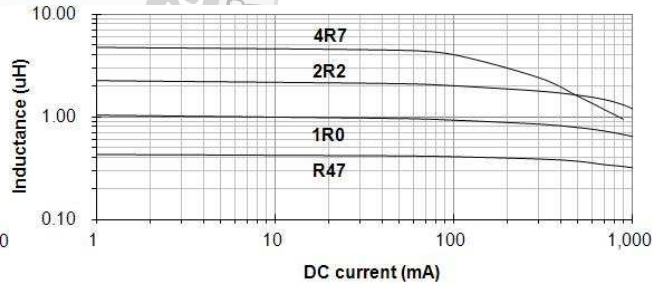

**201609 Series**

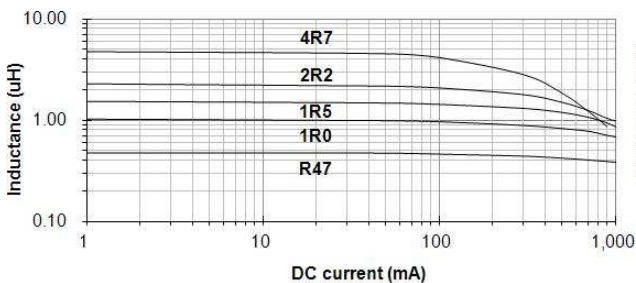

**201205 Series**

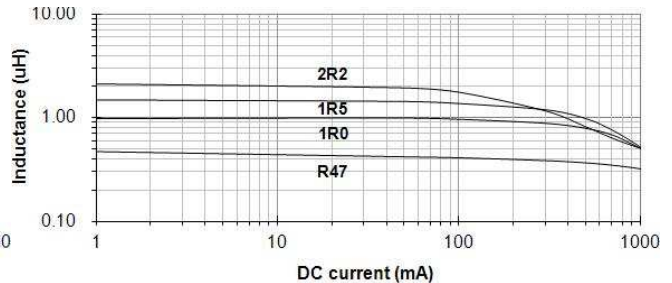

### Temperature vs DC-bias

#### 160808 Series

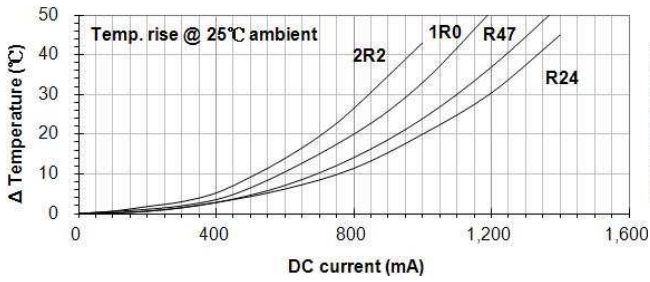

#### 201209 Series

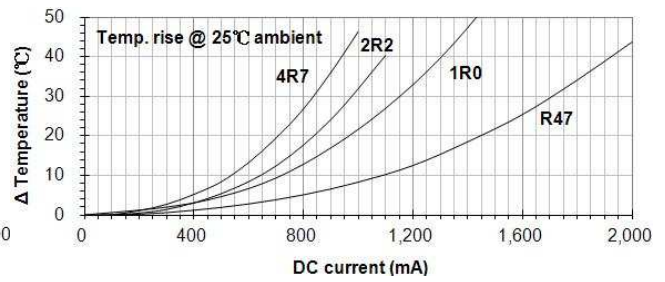

#### 201609 Series

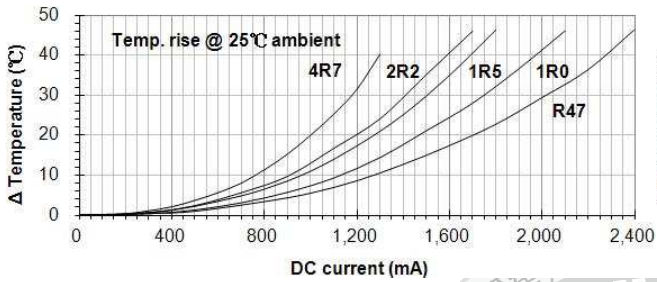

#### 201205 Series

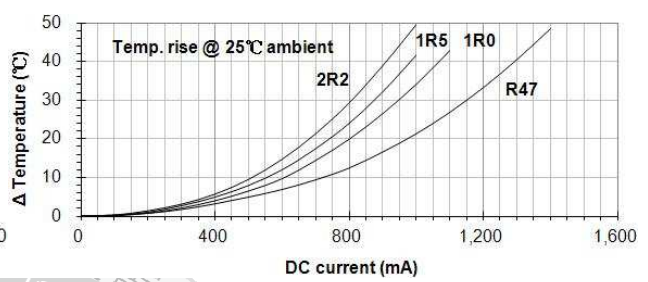

### Land Patterns for Reflow Soldering

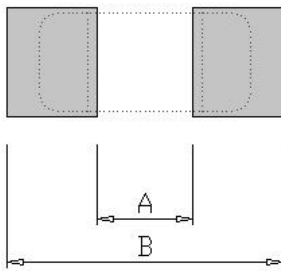

Size (mm)	A	B	C
1608	0.5 ~ 0.7	1.8 ~ 2.0	0.65 ~ 0.95
2012	1.0 ~ 1.2	3.0 ~ 4.0	1.0 ~ 1.4
2016	0.7 ~ 0.9	2.3 ~ 2.5	1.7 ~ 1.9

### Reliability and Test Conditions

Test item	Test condition	Criteria
<b>Resistance to Solder Heat</b>	1. Solder temperature : $260 \pm 5^{\circ}\text{C}$ 2. Flux : Rosin 3. DIP time : $10 \pm 1$ sec	1. More than 95 % of terminal electrode should be covered with new solder 2. No mechanical damage 3. Inductance value should be within $\pm 20$ % of the initial value
<b>Solderability</b>	1. Solder temperature : $235 \pm 5^{\circ}\text{C}$ 2. Flux : Rosin 3. DIP time : $5 \pm 1$ sec	1. More than 95 % of terminal electrode should be covered with new solder 2. No mechanical damage
<b>Adhesive Test</b>	1. Reflow temperature : $245^{\circ}\text{C}$ It shall be soldered on the substrate applying direction parallel to the substrate 2. Apply force(F) : 5 N 3. Test time : 10 sec	1. No mechanical damage 2. Soldering the products on PCB after the pulling test force $> 5$ N
<b>Temperature Cycle</b>	1. Temperature: $-40 \sim 125^{\circ}\text{C}$ for 30 minutes each 2. Cycle: 100 cycles 3. Measurement: at ambient temperature 24 hours after test completion	1. No mechanical damage 2. Inductance should be within $\pm 20\%$ of the initial value (Inductance: $\leq 0.47\mu\text{H}$ ) Inductance should be within $\pm 30\%$ of the initial value (Inductance: $> 0.47\mu\text{H}$ )
<b>High Temperature Resistance</b>	1. Temperature: $85 \pm 5^{\circ}\text{C}$ 2. Testing time: 1000 hours 3. Measurement: at ambient temperature 24 hours after test completion	1. No mechanical damage 2. Inductance should be within $\pm 20\%$ of the initial value (Inductance: $\leq 0.47\mu\text{H}$ ) Inductance should be within $\pm 30\%$ of the initial value (Inductance: $> 0.47\mu\text{H}$ )
<b>Humidity</b>	1. Temperature: $40^{\circ}\text{C} \pm 2^{\circ}\text{C}$ 2. Humidity: 90-95 % RH 3. Testing time: 1000 hours 4. Measurement: at ambient temperature 24 hours after test completion	1. No mechanical damage 2. Inductance should be within $\pm 20\%$ of the initial value
<b>Rated Current</b>	1. At ambient temperature & humidity Testing time: 5 minutes ( under full rated current )	1. Product surface Temp: below room temperature plus $40^{\circ}\text{C}$

### GENERAL TECHNICAL DATA

- Operating temperature range :  $- 40^{\circ}\text{C} \sim +125^{\circ}\text{C}$
- Storage Condition : Less than  $40^{\circ}\text{C}$  and 70% RH
- Storage time : 12 months Max.
- Soldering method : Reflow

**Tape and Reel Specifications**  
**Plastic Carries(E)**

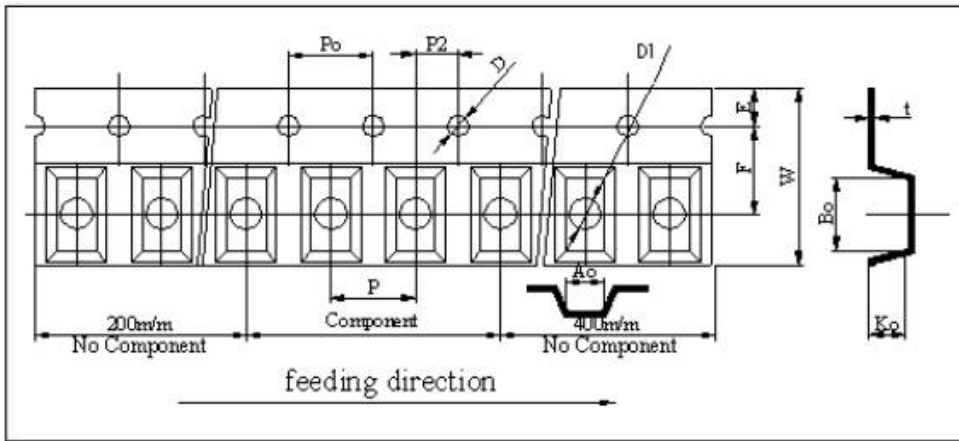

**Paper Carrier(P)**

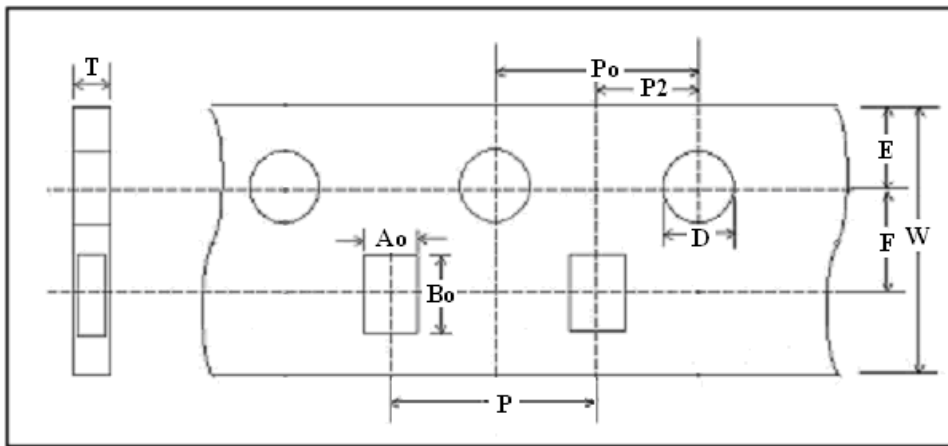

**Taping Dimensions**

(mm)	160808	201209	201205	201609
Symbol	P	E	P	E
W	8.00 ± 0.10	8.00 ± 0.10	8.00 ± 0.10	8.00 ± 0.10
P	4.00 ± 0.10	4.00 ± 0.10	4.00 ± 0.10	4.00 ± 0.10
E	1.75 ± 0.10	1.75 ± 0.10	1.75 ± 0.05	1.75 ± 0.10
F	3.50 ± 0.10	3.50 ± 0.10	3.50 ± 0.05	3.50 ± 0.10
D	1.56 ± 0.10	1.55 ± 0.05	1.55 ± 0.05	1.55 ± 0.05
D1	NA	1.00 ± 0.05	NA	1.00 ± 0.05
Po	4.00 ± 0.10	4.00 ± 0.10	4.00 ± 0.10	4.00 ± 0.10
10Po	40.0 ± 0.20	40.0 ± 0.20	40.0 ± 0.10	40.0 ± 0.20
P2	2.00 ± 0.10	2.00 ± 0.10	2.00 ± 0.05	2.00 ± 0.10
Ao	0.97 ± 0.05	1.40 ± 0.10	1.45 ± 0.05	1.90 ± 0.10
Bo	1.80 ± 0.05	2.30 ± 0.10	2.25 ± 0.05	2.30 ± 0.10
Ko(T)	0.75 ± 0.05	1.13 ± 0.10	0.60 ± 0.03	1.15 ± 0.10
t	NA	0.22 ± 0.05	NA	0.22 ± 0.05

### Reel Dimensions

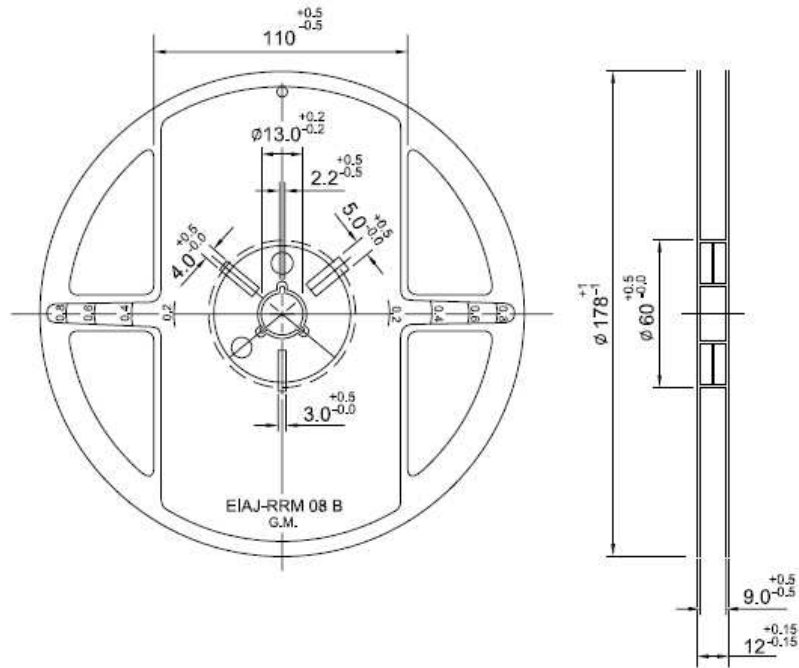

7" Reel Packaging Quantity				
PART SIZE	160808	201209	201205	201609
Qty.(pcs)	4,000	3,000	4,000	3,000
BOX	5 reels / inner box	5 reels / inner box	5 reels / inner box	5 reels / inner box

### Recommended Soldering Conditions

