

High Power LED S-Series

0.7W White

SPHWHTS2N100



Features

- Package : Lead frame package
- Dimension : 2.30 mm x 2.30 mm
- Chip Technology : Flip Chip
- ESD : 8 kV acc. to ANSI/ESDA/JEDEC JS-001 (HBM)
- Qualifications : AEC-Q102 Qualified with RV-level 1

Table of Contents

| | | | |
|-----|--------------------------------|-------|----|
| 1. | Characteristics | ----- | 3 |
| 2. | Product Code Information | ----- | 4 |
| 3. | Typical Characteristics Graphs | ----- | 7 |
| 4. | Soldering Temperature Location | ----- | 12 |
| 5. | Mechanical Dimension | ----- | 13 |
| 6. | Soldering Conditions | ----- | 14 |
| 7. | Tape & Reel | ----- | 15 |
| 8. | Label Structure | ----- | 16 |
| 9. | Packing Structure | ----- | 17 |
| 10. | Handling and Use Precautions | ----- | 18 |
| 11. | Company Information | ----- | 19 |

1. Characteristics

a) Typical Characteristics ($T_s = 25^\circ\text{C}$)^[1]

| Item | Symbol | Value | Unit. |
|---|-----------------------------|------------------------------------|-----------------|
| Chromaticity Coordinate | C _x | 0.32 | |
| | C _y | 0.33 | |
| Luminous Flux ($I_F = 200 \text{ mA}$) | Φ_V | Typ. 90 | lm |
| Forward Voltage ($I_F = 200 \text{ mA}$) | V _F | Typ. 2.9 | V |
| Viewing Angle | Φ | Typ. 120 | ° |
| Reverse Current | I _R | Not designed for reverse operation | |
| Real Thermal Resistance (Junction to Solder point) | R _{th_J-S (Real)} | Typ. 7.3 | K/W |
| | | Max. 10.9 | |
| Electrical Thermal Resistance (Junction to Solder point) | R _{th_J-S (Elec.)} | Typ. 4.2 | K/W |
| | | Max. 6.3 | |
| Radiant Surface | A | 0.81 | mm ² |

Note:

[1] The measurement condition means that temperature dependence is excluded by applying pulse current for typically 25 ms

b) Absolute Maximum Rating

| Item | Symbol | Rating | Unit |
|---|------------------|----------------------------------|------|
| Ambient / Operating Temperature | T _a | -40 ~ +125 | °C |
| Storage Temperature | T _{stg} | -40 ~ +125 | °C |
| LED Junction Temperature | T _j | 150 | °C |
| Maximum Forward current ^[2] (T _s :25°C) ^[3] | I _F | 300 | mA |
| Minimum Forward current ^[2] (T _s :25°C) ^[3] | I _F | 50 | mA |
| Maximum Reverse current | | Do not apply for reverse current | |
| ESD Sensitivity ^[4] | - | ±8 for HBM | kV |

Note:

[2] Driving the product at forward current (I_F) below Min. I_F or above Max. I_F may result in unpredictable behavior of the product.

[3] The measurement condition means that temperature dependence is excluded by applying pulse current for typically 25 ms

[4] It is included the device to protect the product from ESD.

2. Product Code Information

| | | | | | | | | | | | | | | | | | |
|---|---|---|---|---|---|---|---|---|----|----|----|----|----|----|----|----|----|
| 1 | 2 | 3 | 4 | 5 | 6 | 7 | 8 | 9 | 10 | 11 | 12 | 13 | 14 | 15 | 16 | 17 | 18 |
| S | P | H | W | H | T | S | 2 | N | 1 | 0 | 0 | A | B | C | D | E | F |

| Digit | PKG Information |
|-------|--|
| 1 2 | Company name and Samsung LED PKG (SP for Samsung PKG) |
| 3 | Power variant (H for automotive high power) |
| 4 5 | Color variant (WH for automotive white color) |
| 6 | LED PKG version (T for initial version) |
| 7 8 | Product configuration and type (S2 for automotive 2323 PKG type) |
| 9 | Lens configuration (N for no lens) |
| 10 | Max power (Internal Code) |
| 11,12 | Specific property (00 for default) |
| 13 14 | Forward voltage property |
| 15 16 | CIE coordination property |
| 17 18 | Luminous flux property |

a) Luminous Flux Bins ^[5] ($I_F = 200 \text{ mA}$, $T_S = 25^\circ\text{C}$)

| Symbol | Flux Bin Code | Flux Range (lm) | |
|----------|---------------|-----------------|-----|
| | | Min | Max |
| Φ_V | 8A | 80 | 88 |
| | 1B | 84 | 93 |
| | 2B | 88 | 97 |
| | 3B | 93 | 102 |
| | 4B | 97 | 107 |

b) Voltage Bins ($I_F = 200 \text{ mA}$, $T_S = 25^\circ\text{C}$)

| Symbol | Voltage Bin Code | Voltage Range (V) | |
|--------|------------------|-------------------|------|
| | | Min | Max |
| V_F | 1D | 2.75 | 3.00 |
| | 1E | 3.00 | 3.25 |
| | 1H | 3.25 | 3.40 |

Note:

[5] Luminous flux measuring equipment : CAS140CT

Φ_V and V_F tolerances are $\pm 7\%$ and $\pm 0.1 \text{ V}$ respectively.

c) Color Bin ^[6](I_F = 200 mA)

| Symbol | Color Bin Code | Cx | | | | Cy | | | |
|--------|----------------|--------|--------|--------|--------|--------|--------|--------|--------|
| Cx, Cy | R2 | 0.3241 | 0.3248 | 0.3350 | 0.3355 | 0.3534 | 0.3370 | 0.3460 | 0.3633 |
| | S2 | 0.3190 | 0.3203 | 0.3299 | 0.3298 | 0.3430 | 0.3274 | 0.3361 | 0.3526 |
| | T2 | 0.3163 | 0.3145 | 0.3246 | 0.3253 | 0.3181 | 0.3330 | 0.3424 | 0.3266 |
| | U2 | 0.3127 | 0.3104 | 0.3199 | 0.3212 | 0.3093 | 0.3234 | 0.3325 | 0.3175 |

Note

[6] Chromaticity coordinates : Cx, Cy according to CIE 1931. Cx and Cy tolerances are ±0.005, respectively.

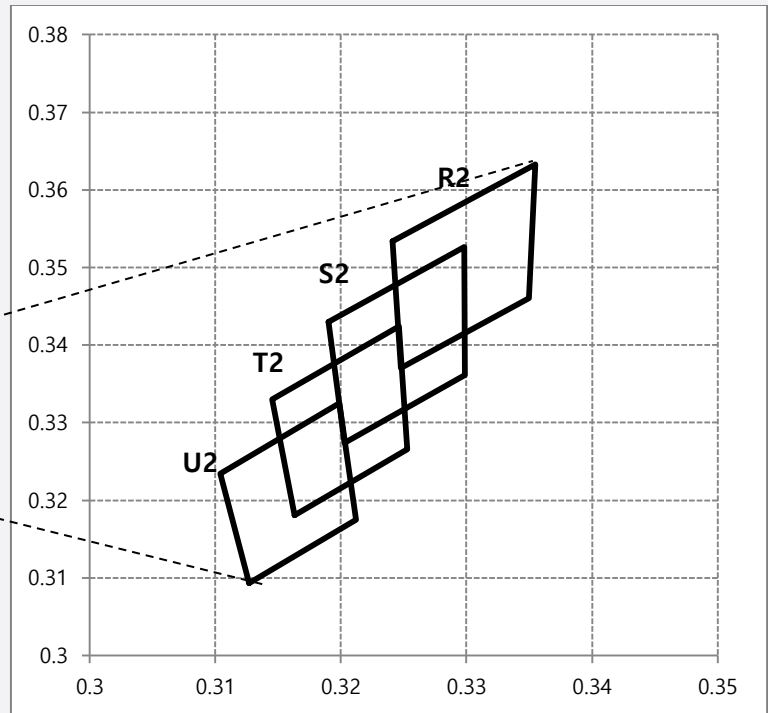
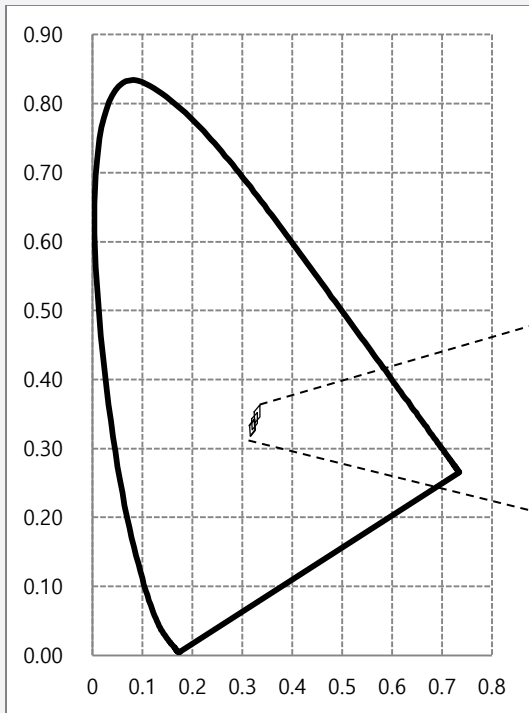

d) Luminous Flux Bins according to Color Bin (I_F = 200 mA, T_S = 25 °C)

| Symbol | Flux Bin Code | Flux Range (lm) | | | | | | | | | |
|----------------|---------------|-----------------|-----|-----|-----|-----|-----|-----|-----|-----|-----|
| | | 8A | | 1B | | 2B | | 3B | | 4B | |
| | | Min | Max | Min | Max | Min | Max | Min | Max | Min | Max |
| | | 80 | 88 | 84 | 93 | 88 | 97 | 93 | 102 | 97 | 107 |
| Φ _v | R2 | | | ○ | | ○ | | ○ | | ○ | |
| | S2 | | | ○ | | ○ | | ○ | | | |
| | T2 | | | ○ | | ○ | | ○ | | | |
| | U2 | ○ | | ○ | | ○ | | ○ | | | |

3. Typical Characteristics Graphs

a) Spectrum Distribution ($I_F = 200 \text{ mA}$, $T_S = 25 \text{ }^\circ\text{C}$)

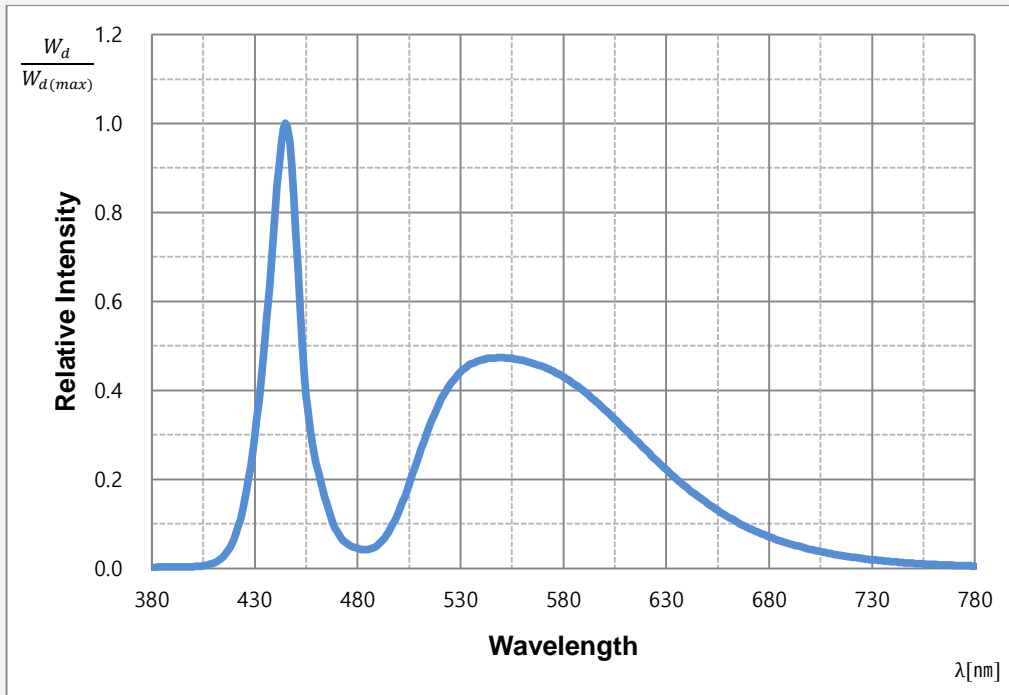

b) Typical Chromaticity Coordinate Shift vs Radiation Angle ($I_F = 200 \text{ mA}$, $T_S = 25 \text{ }^\circ\text{C}$) [7]

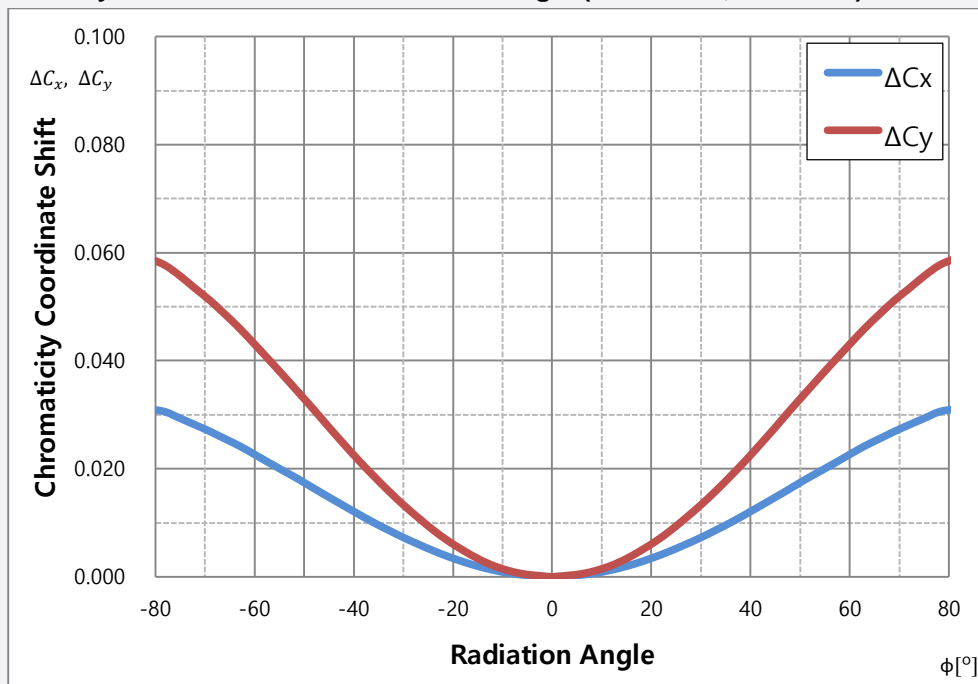

Note:

[7] The measurement condition means that temperature dependence is excluded by applying pulse current for typically 25 ms

c) Forward Current Characteristics ($T_s = 25\text{ }^\circ\text{C}$) [8]

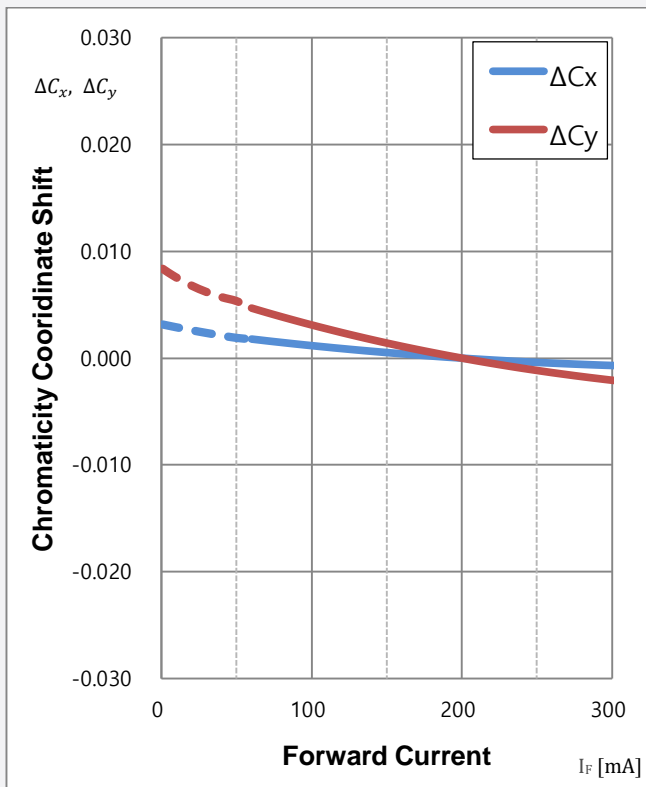
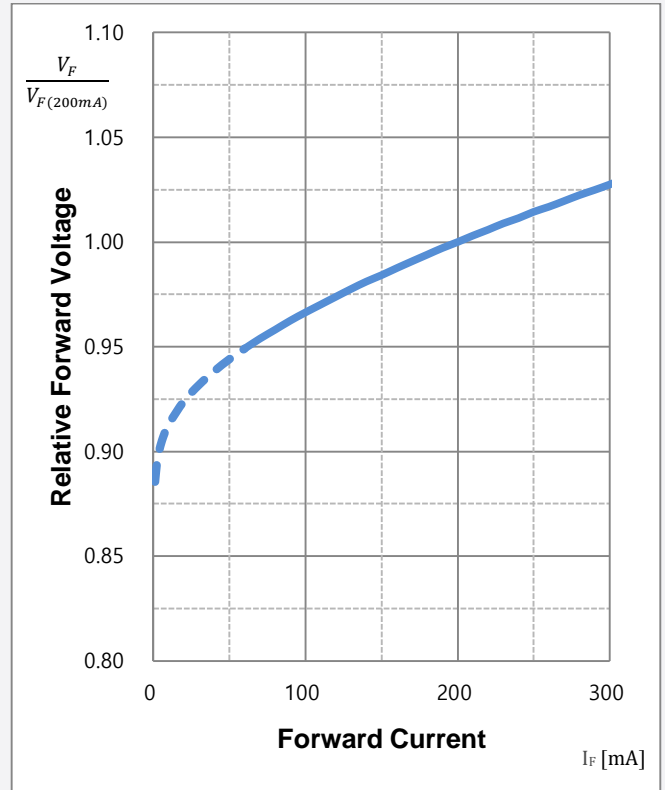
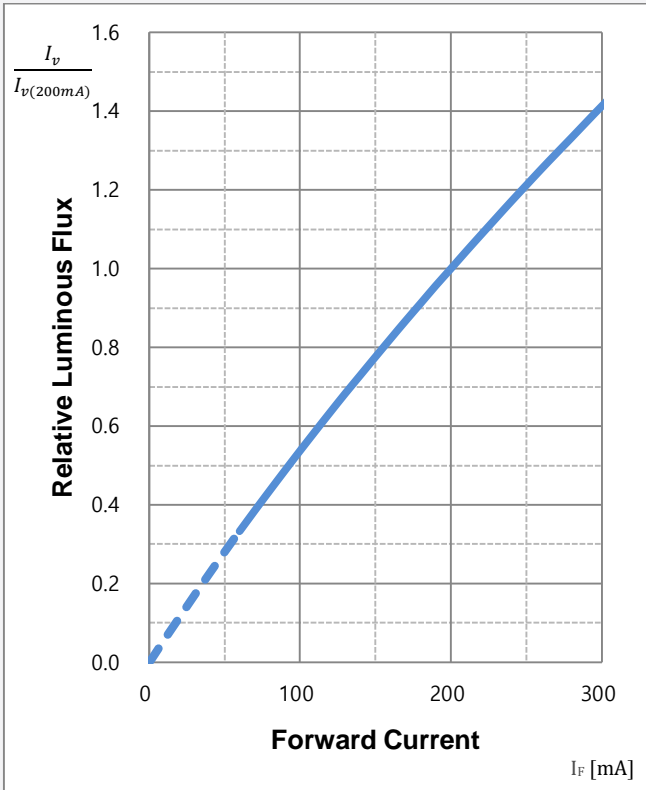

Note:

[8] The measurement condition means that temperature dependence is excluded by applying pulse current for typically 25 ms

d) Temperature Characteristics ($I_F = 200 \text{ mA}$)

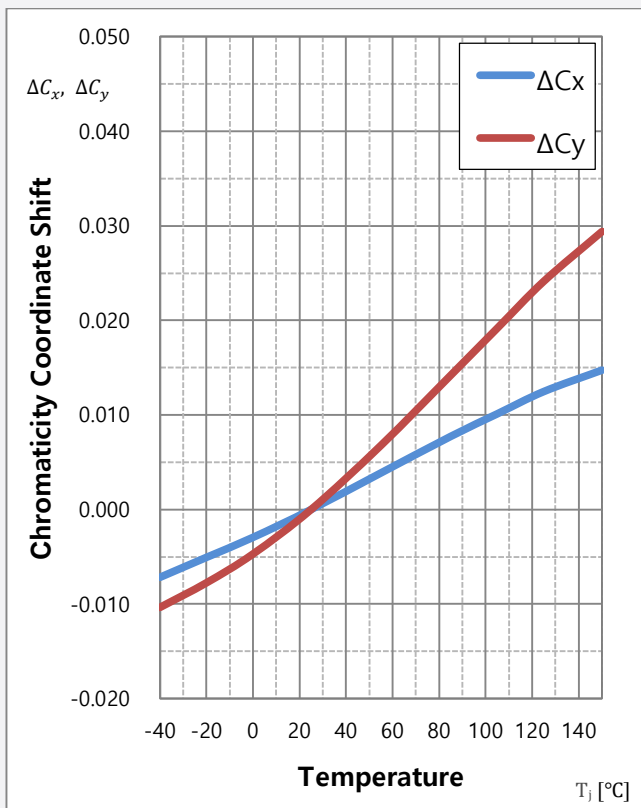
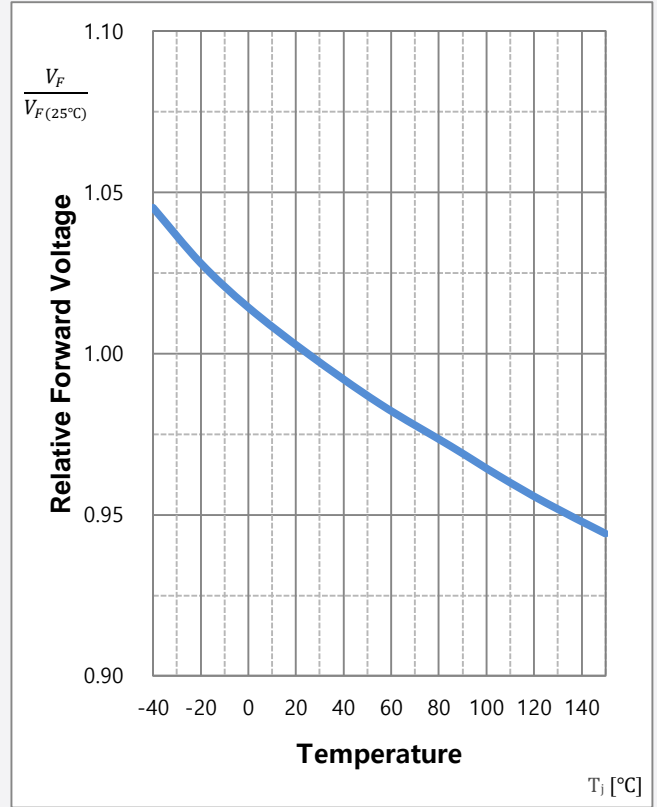
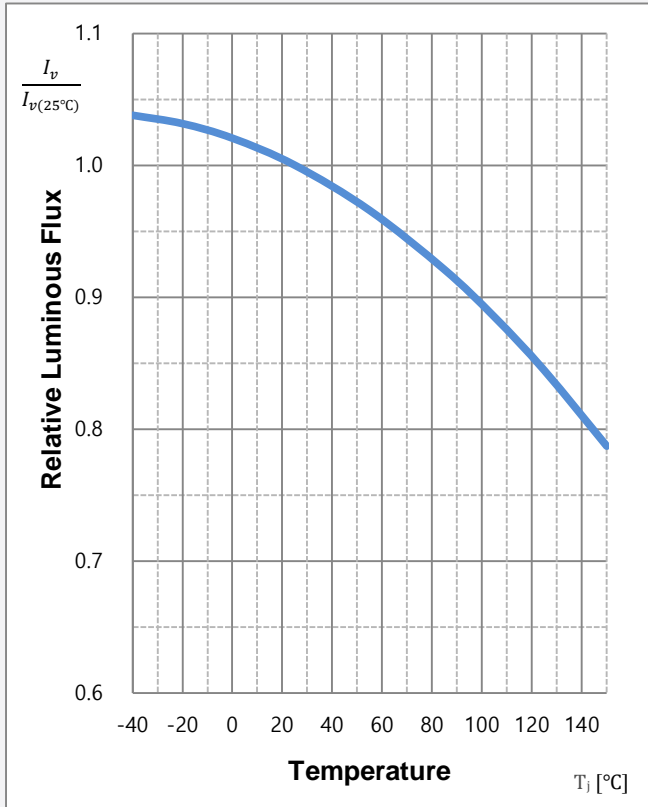

e) Derating Curve ^[9]

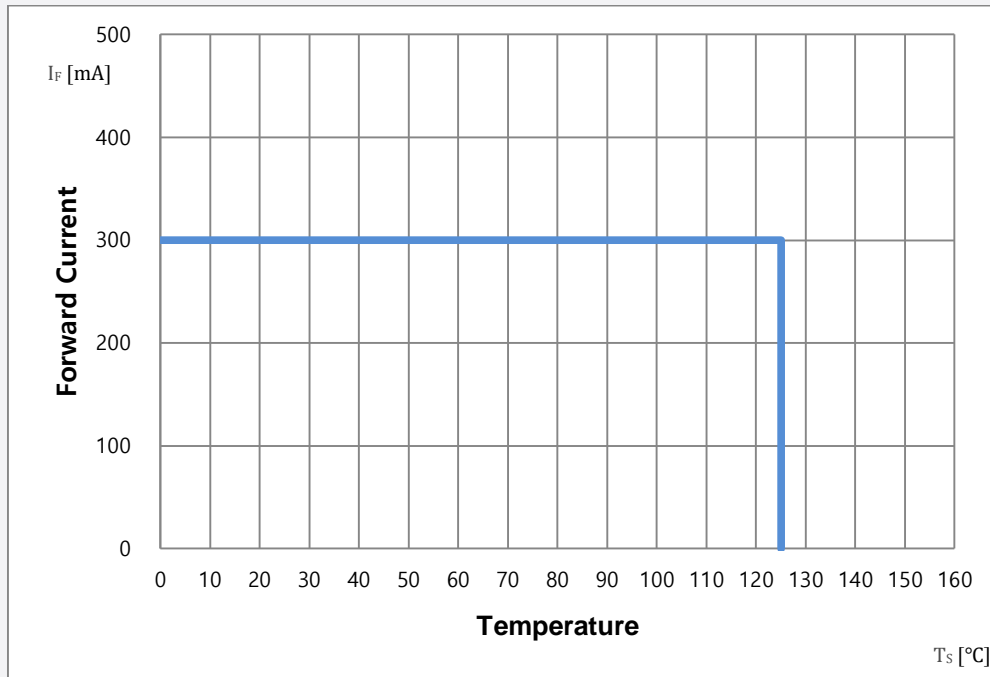

Note:

[9] The measurement condition means that temperature dependence is excluded by applying pulse current for typically 25 ms

f) Permissible Pulse Handling Capability ($I_F = f(t_p)$; D: Duty cycle, $T_s = 125$ °C)

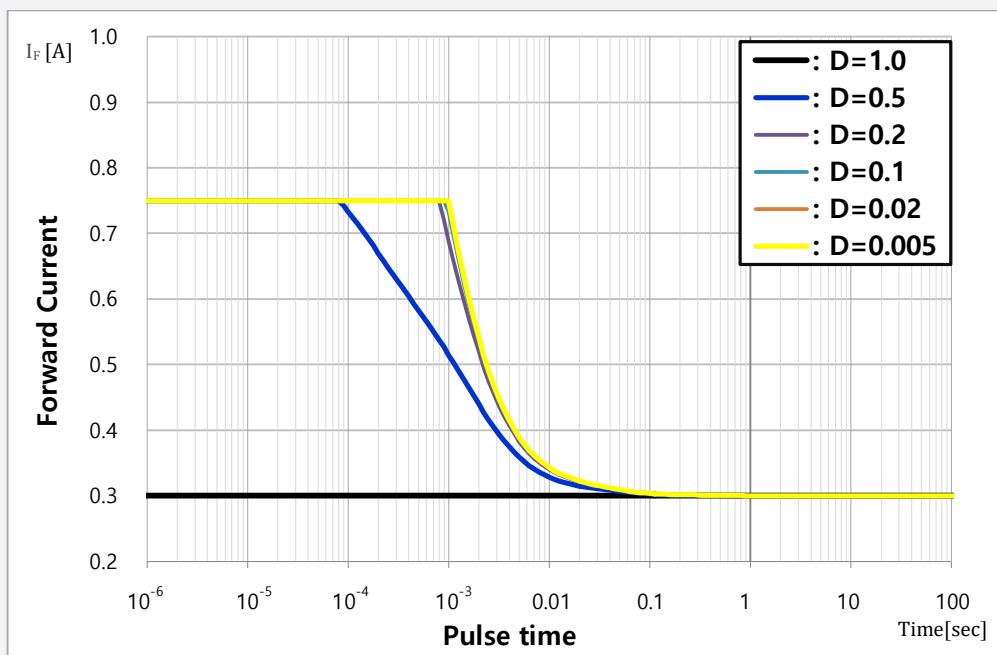

g) Beam Angle Characteristics ($I_F = 200 \text{ mA}$, $T_S = 25 \text{ }^\circ\text{C}$)

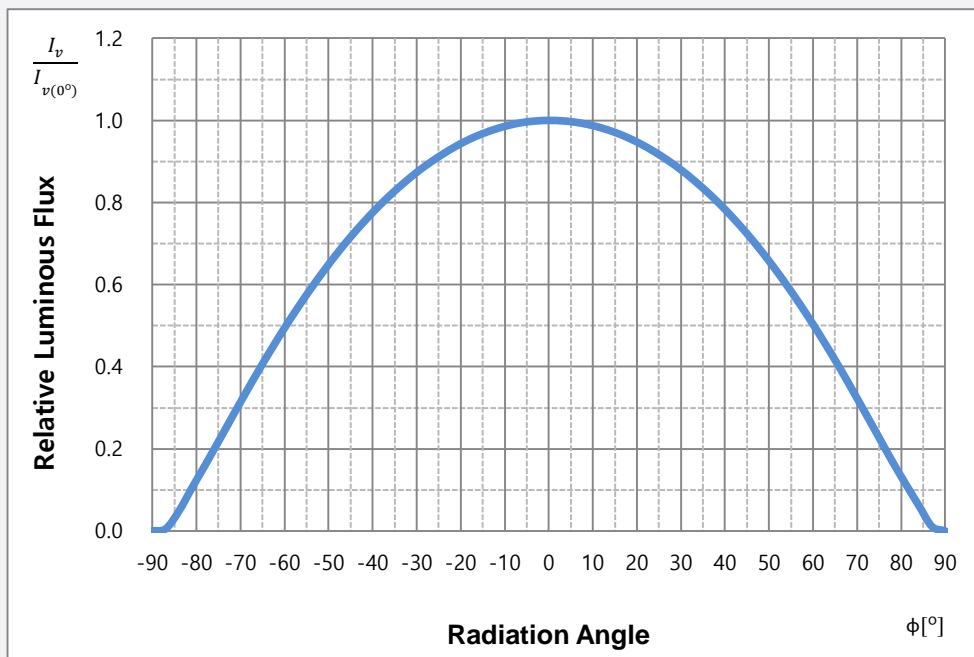

4. Soldering Temperature Location

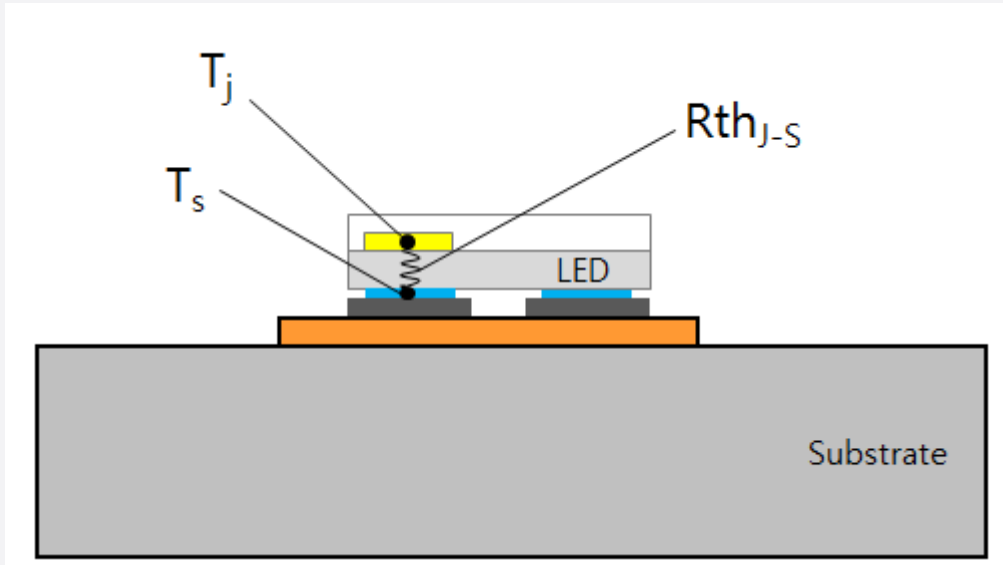

T_j : Temperature of Junction

T_s : Temperature of Solder Pad

$R_{th_{j-s}}$: Thermal Resistance from Junction to Solder Pad

5. Mechanical Dimension

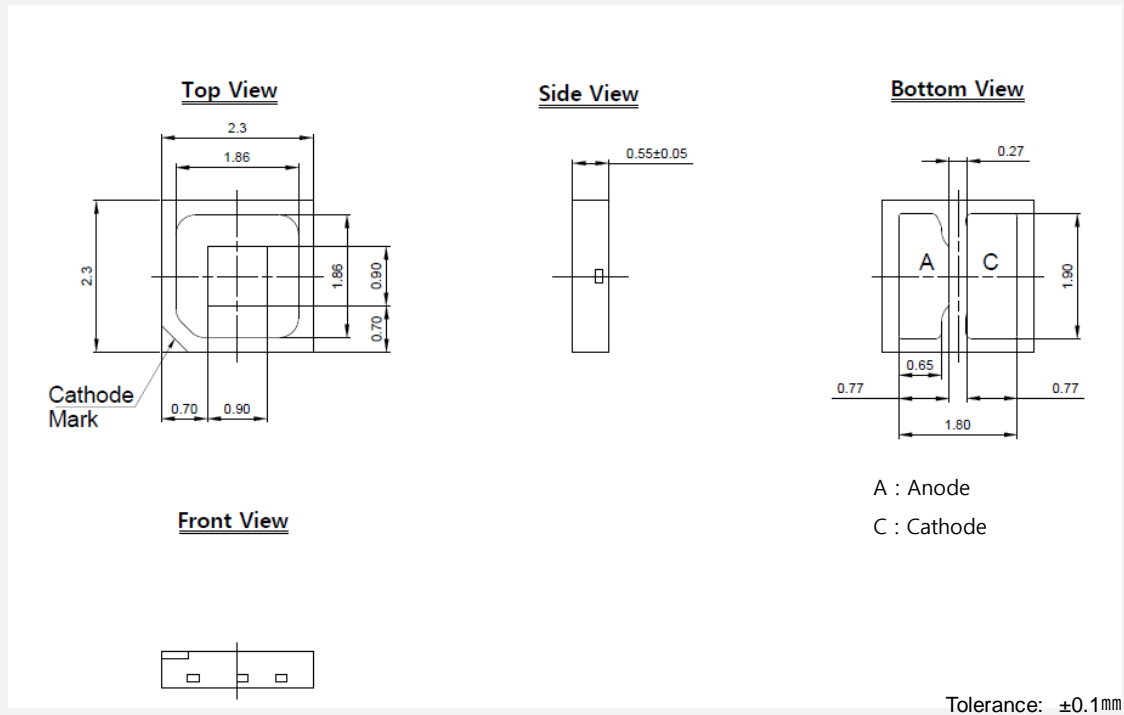

Note:

Approximate weight : 10.5mg.

Unit: mm

a) Pick and Place

Do not place pressure on the resin molded part

It is recommended to use a pick & place nozzle CNT 3X5, etc.

b) Electric Schematic Diagram

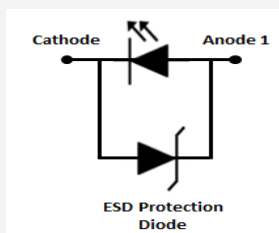

c) Material Information

| Description | Material |
|-------------|-------------------|
| Substrate | SMC Cu Lead Frame |
| LED Die | GaN |
| Phosphor | Silicone |
| Zener Diode | Silicon |
| Wire | Au |
| Resin Mold | Silicone |

6. Soldering Conditions

a) Pad Configuration & Sold Pad Layout

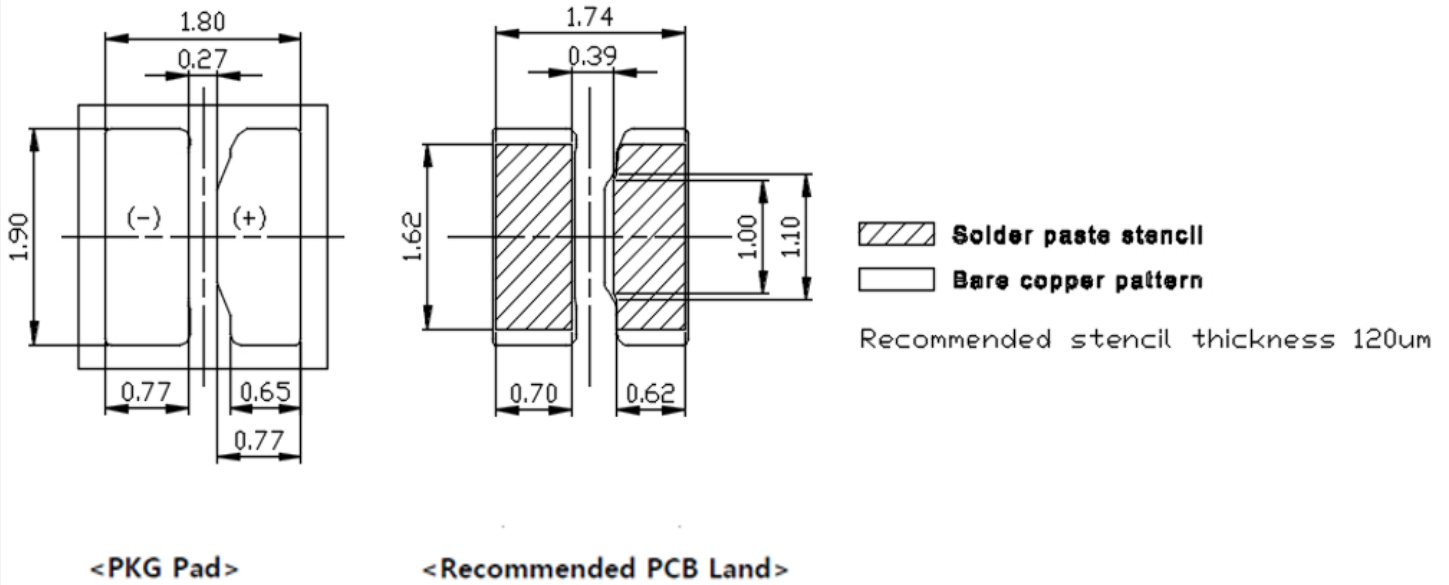

Notes:

Unit: mm, Tolerance: ± 0.10 mm, recommended stencil thickness 120 μ m

b) Reflow Conditions (Pb free)

Reflow frequency: 2 times max.

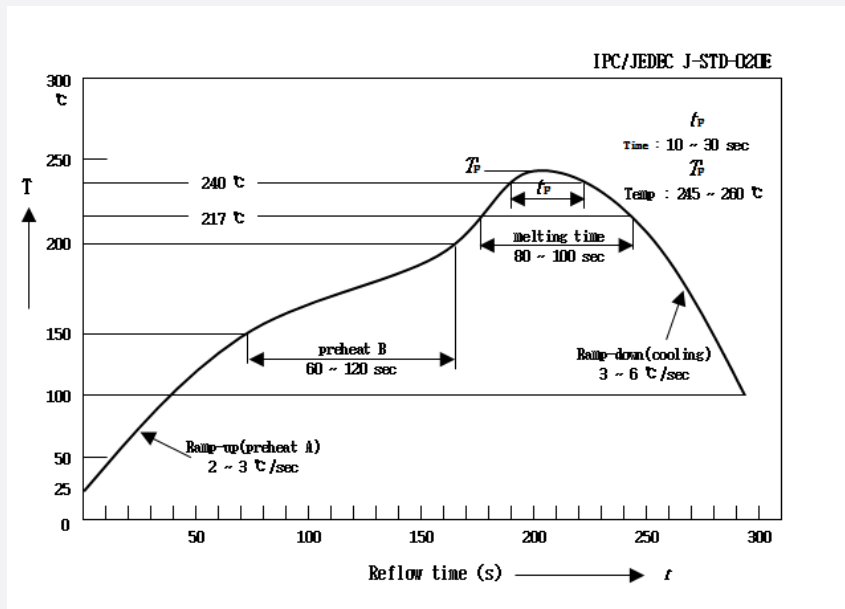

c) Manual Soldering Conditions

Not more than 5 seconds @ max. 300 °C, under soldering iron.(one time only)

7. Tape & Reel

a) Taping Dimension

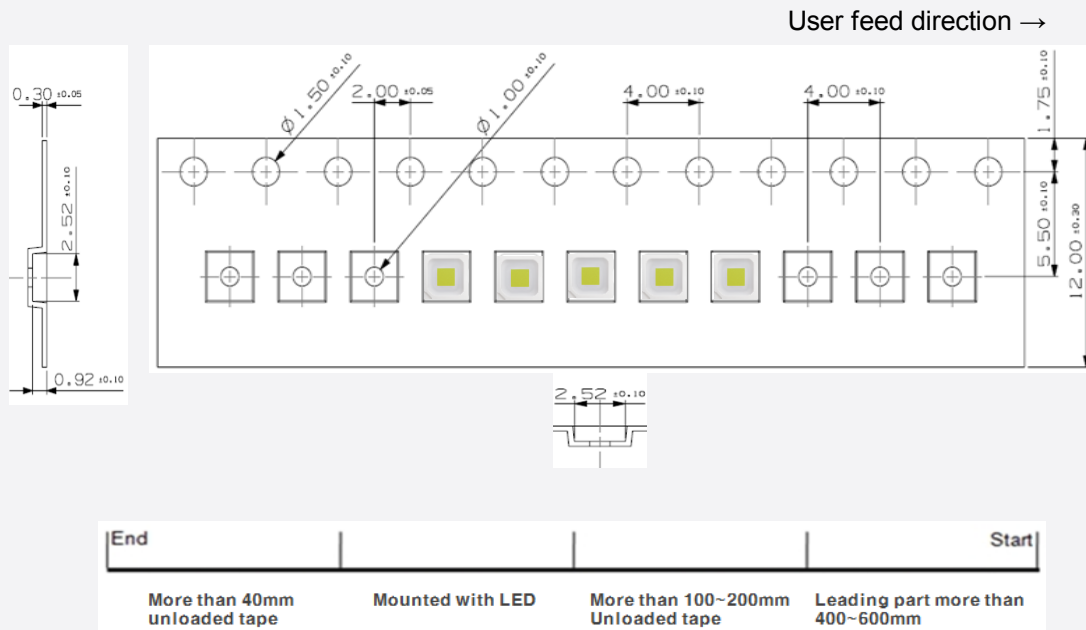

Notes:

Unit: mm, LED taping quantity: 3,000EA / Reel

b) Reel Dimension

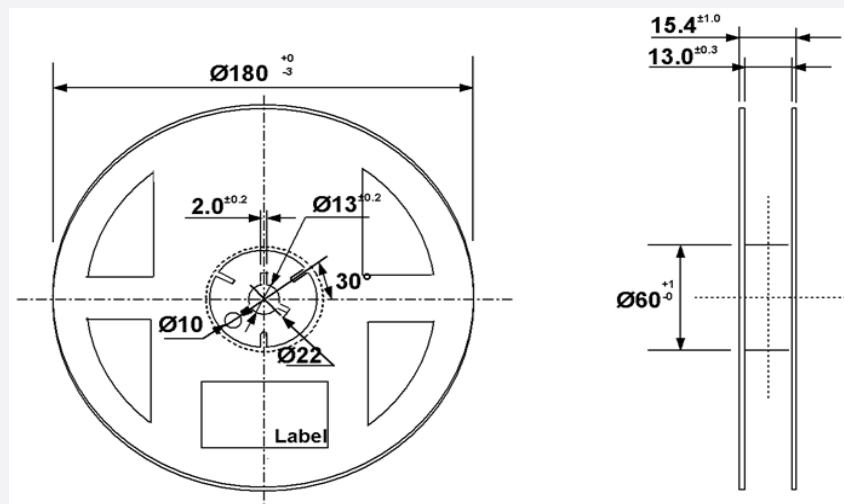

Notes:

Unit: mm, Tolerance: ± 0.20 mm

8. Label Structure

a) Label Structure

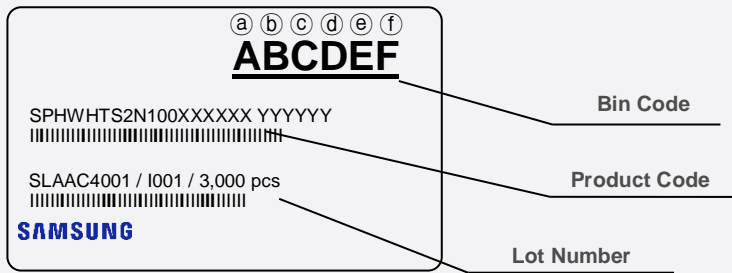

Note: Denoted bin code and product code above is only an example (see description on page 5,6)

Bin Code:

- ⒶⒷ: Forward Voltage bin (refer to page 5)
- ⒸⒹ: Chromaticity bin (refer to page 6)
- ⒺⒻ: Luminous Flux bin (refer to page 5)

b) Lot Number

The lot number is composed of the following characters:

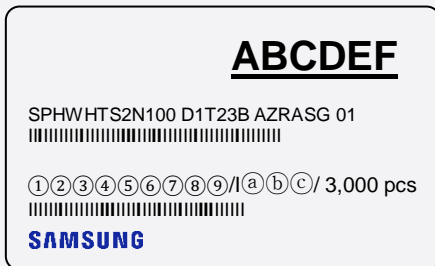

①②③③②③④⑤⑥⑦⑧⑨ / IⒶⒷⒸ / 3,000 pcs

- | | |
|-----|---|
| ①② | : Production site |
| ③ | : Product state (A: Normal, B: Bulk, C: First Production, R: Reproduction, S: Sample) |
| ④ | : Year (G: 2022, H: 2023, I: 2024...) |
| ⑤ | : Month (1~9, A, B, C) |
| ⑥ | : Day (1~9, A, B~V) |
| ⑦⑧⑨ | : Serial number (001 ~ 999) |
| ⒶⒷⒸ | : Product serial number (001 ~ 999) |

9. Packing Structure

a) Packing Process

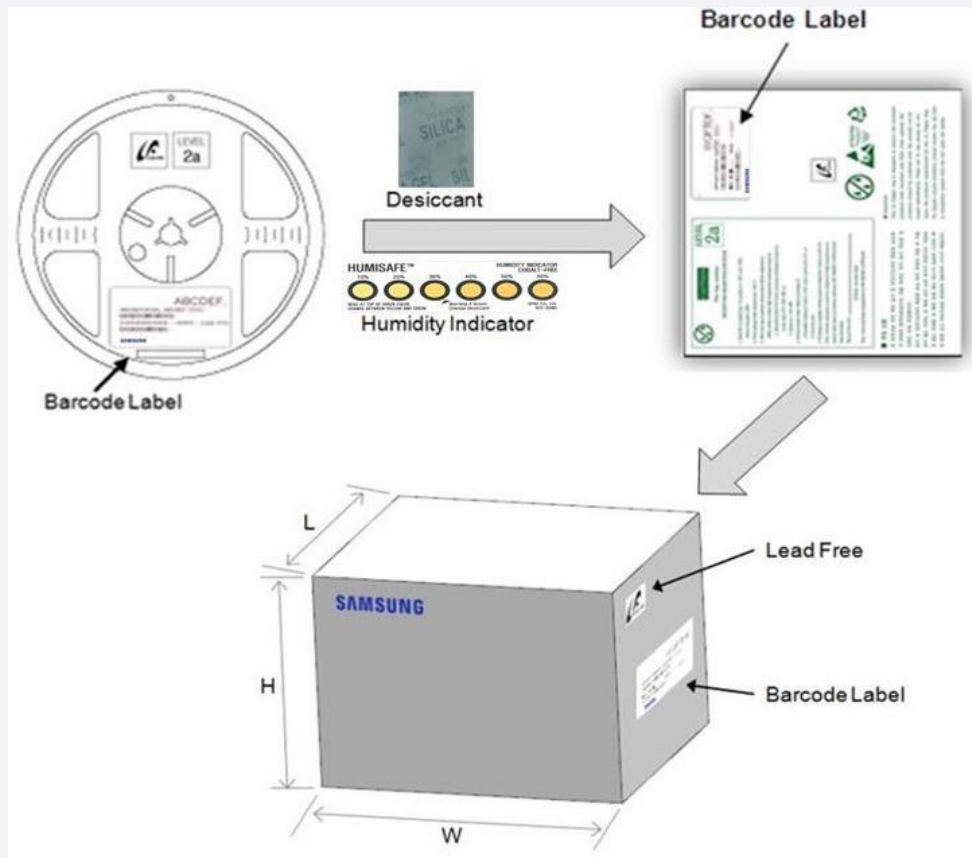

Dimension of Transportation Box in mm

| Width | Length | Height |
|-------|--------|--------|
| 220 | 245 | 182 |

10. Handling and Use Precautions

- 1) For over-current protection, we recommend the use of resistors to prevent sudden current surges caused by slight shifts in voltage.
- 2) LEDs should not be contacted to any type of fluid (i.e. water, oil, organic solvent, etc.). If cleaning is required, only use isopropyl alcohol.
- 3) The maximum ambient temperature must be considered in order for the maximum temperature ratings not to be exceeded.
- 4) LEDs must be stored in a clean environment. If the LEDs are to be stored for 3 months or more after being shipped from Samsung Electronics, they should be packed by a sealed container with nitrogen gas injected. (Shelf life of sealed bags: 12 months, temp. $\sim 40^{\circ}\text{C}$, $\sim 90\%$ RH)
- 5) After storage bag is open, LED subjected to soldering, solder reflow, or other high temperature processes must be:
 - a. Mounted within 672 hours (28 days) at an assembly line with a condition of no more than 30°C / 60% RH.
 - b. Stored at $<10\%$ RH.
- 6) Repack unused products using anti-moisture packing, fold to close any openings and store in a dry place with $<10\%$ RH
- 7) LEDs require baking before mounting, if humidity card reading is $>60\%$ at $23\pm 5^{\circ}\text{C}$.
- 8) If baking is required, LEDs must be baked for 1 day at $60\pm 5^{\circ}\text{C}$.
- 9) LEDs are sensitive to electrostatic discharge and surges. Applying any voltage exceeding the absolute maximum rating of the LED can cause permanent damage to the device. Damaged LEDs may have some unusual characteristics such as increased leakage current, lower turn-on voltage or may light abnormally at low current. When handling LEDs, using grounding wrist-bands or anti-static gloves is recommended.
- 10) VOCs (volatile organic compounds) present in adhesives, flux, hardeners or organic additives, etc. that are used in luminaires may lead to discoloration of the LED when exposed to heat or light. Note that VOCs can permeate silicone bags. This phenomenon can significantly affect light output from the luminaire. To avoid this issue, please carefully evaluate materials used in your process and/or luminaire to be free of VOCs.

11. Company Information

SAMSUNG

US

Samsung Semiconductor, Inc.
11800 Amber park Drive #225 Alpharetta, GA 30004 USA
Tel : +1 678 892 7385

Europe

Samsung Semiconductor Europe GmbH,
Einsteinstrasse 174, 81677 Munich, Germany
Tel : +49 6196 66 3902

Japan

Samsung Japan Corporation
10F, Shinagawa Grand Central Tower 2-16-4, Kounan, Minato-ku, Tokyo
108-8240, Japan
Tel : +81 3 6369 6267

China(Shenzhen)

Samsung Electronics Co., Ltd.
25F/26F, SCC building A, No.88, Haide Yi Road, Nanshan District,
518026, Shenzhen China
Tel : +86 21 2325 3551

China(Shanghai)

Samsung Electronics Co., Ltd.
Building B, No 1065 Zhongshan RD(W), Changning District, Shanghai,
China
Tel : +86 21 2325 3504

India

Samsung Electronics
Suite #006 Ground Floor, Copia Corporate Suites, Jasola, New Delhi
110025, India, Delhi, IND
Tel : +91 9600003320

Copyright @1995-2022 All rights reserved

Samsung Electronics LED BUSINESS

1, Samsung-ro Giheung-gu
Yongin-si, Gyeonggi-do 17113 Korea

<http://www.samsung.com/led>

Sales Contact

leedw007@samsung.com

jh0932.yang@samsung.com

SAMSUNG

Legal and additional information.

[About Samsung Electronics Co., Ltd.](#)

Samsung inspires the world and shapes the future with transformative ideas and technologies. The company is redefining the worlds of TVs, smartphones, wearable devices, tablets, digital appliances, network systems, and memory, system LSI, foundry and LED solutions. For the latest news, please visit the Samsung Newsroom at news.samsung.com.

Copyright © 2022 Samsung Electronics Co., Ltd. All rights reserved.
Samsung is a registered trademark of Samsung Electronics Co., Ltd.
Specifications and designs are subject to change without notice. Non-metric weights and measurements are approximate. All data were deemed correct at time of creation. Samsung is not liable for errors or omissions. All brand, product, service names and logos are trademarks and/or registered trademarks of their respective owners and are hereby recognized and acknowledged.

Samsung Electronics Co., Ltd.
1, Samsung-ro
Giheung-gu
Yongin-si, Gyeonggi-do, 17113
KOREA

www.samsung.com/led

SAMSUNG