

THIS DRAWING IS UNPUBLISHED. RELEASED FOR PUBLICATION 20  
 © COPYRIGHT 20 BY - ALL RIGHTS RESERVED.

| REVISIONS |     |               |           |       |
|-----------|-----|---------------|-----------|-------|
| P         | LTR | DESCRIPTION   | DATE      | APVD  |
| C         |     | ECR-21-119335 | 25JUN2022 | TL HL |
|           |     |               |           |       |
|           |     |               |           |       |

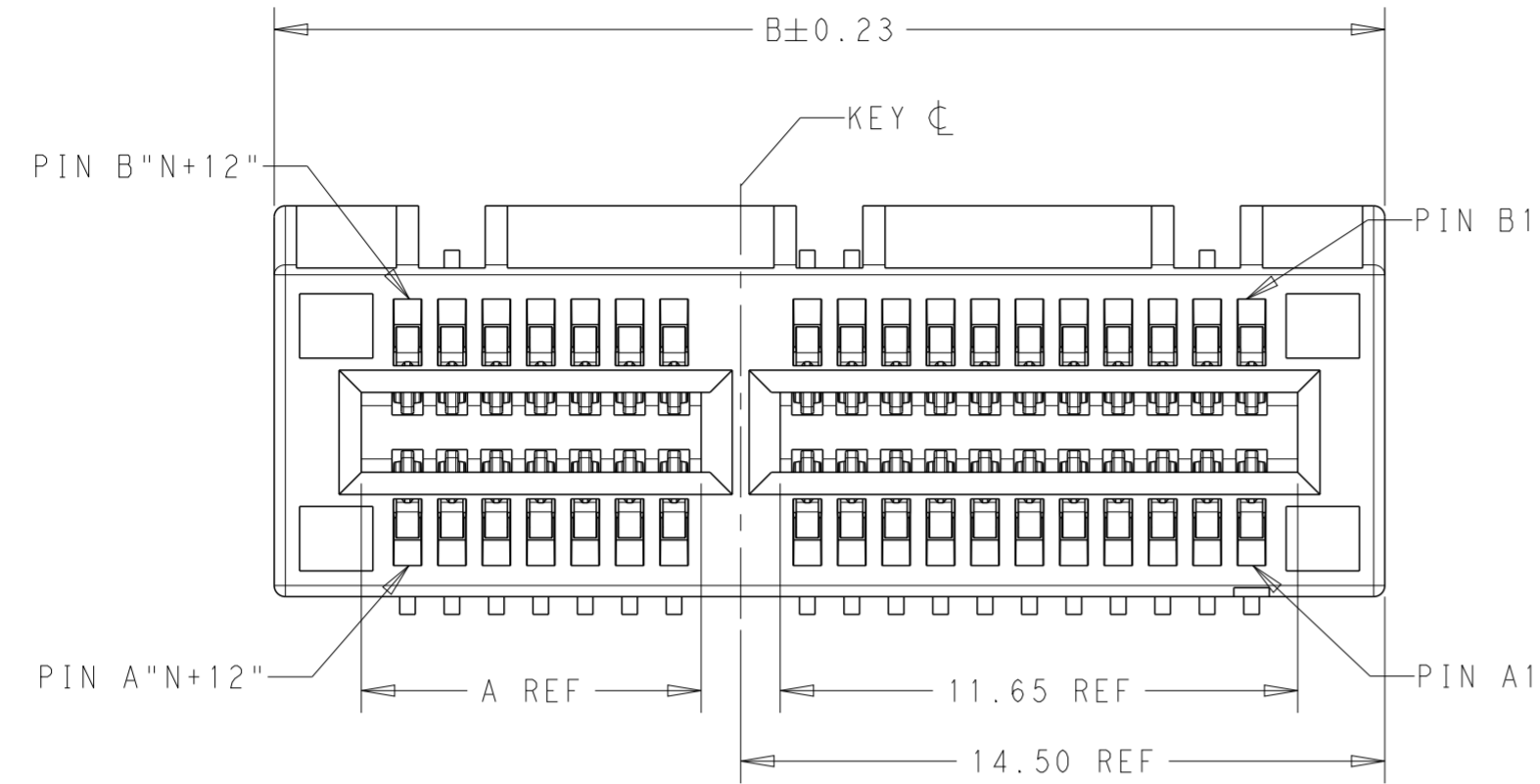

NOTES:

- 1 MATERIAL:  
HOUSING: LCP UL94V-0; BLACK  
CONTACT: COPPER ALLOY  
TAB: COPPER ALLOY OR STAINLESS STEEL
- 2 FINISH:  
(SEE TABLE)  $\mu\text{m}$  GOLD PLATING ON CONTACT AREA.  
2.54  $\mu\text{m}$  MATTE-TIN PLATING ON SOLDER TAIL AREA.  
1.27  $\mu\text{m}$  NICKEL UNDERPLATING OVERALL.
- 3 PART NUMBR AND DC PRINTED IN APROPRIATE AREA OR OPPOSITE

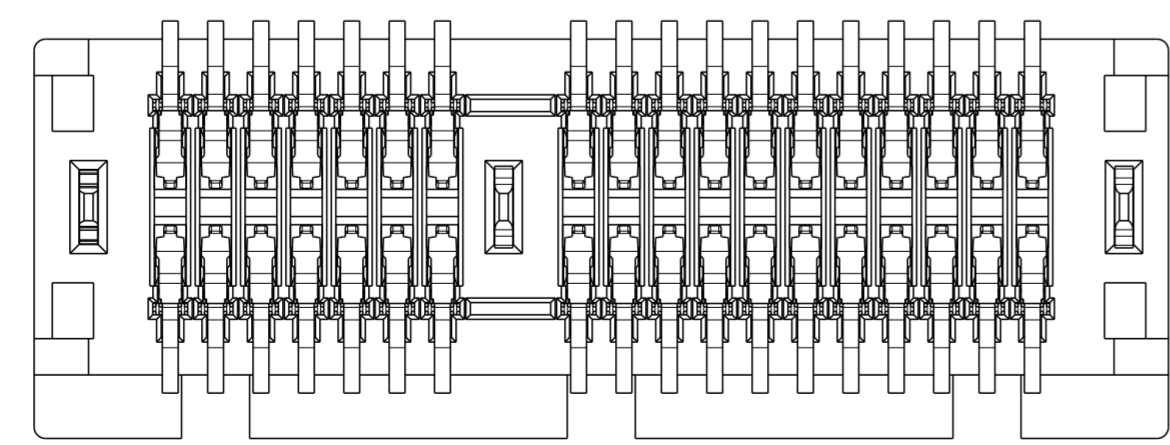
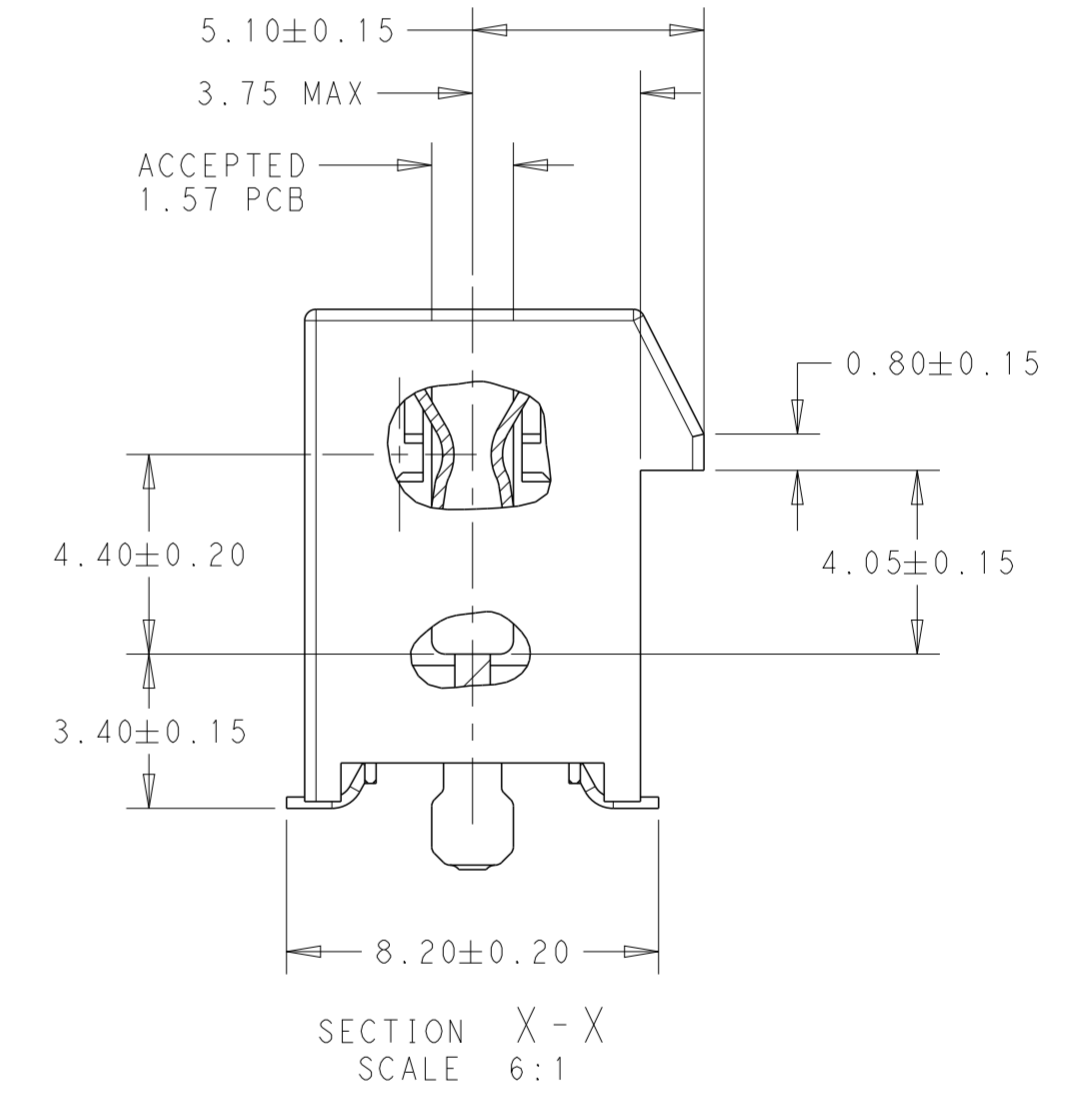
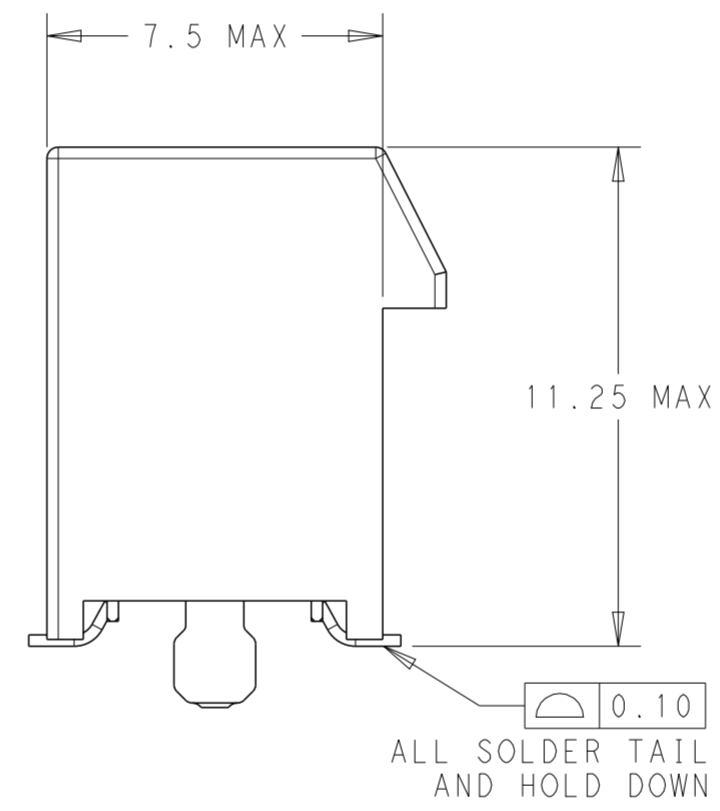
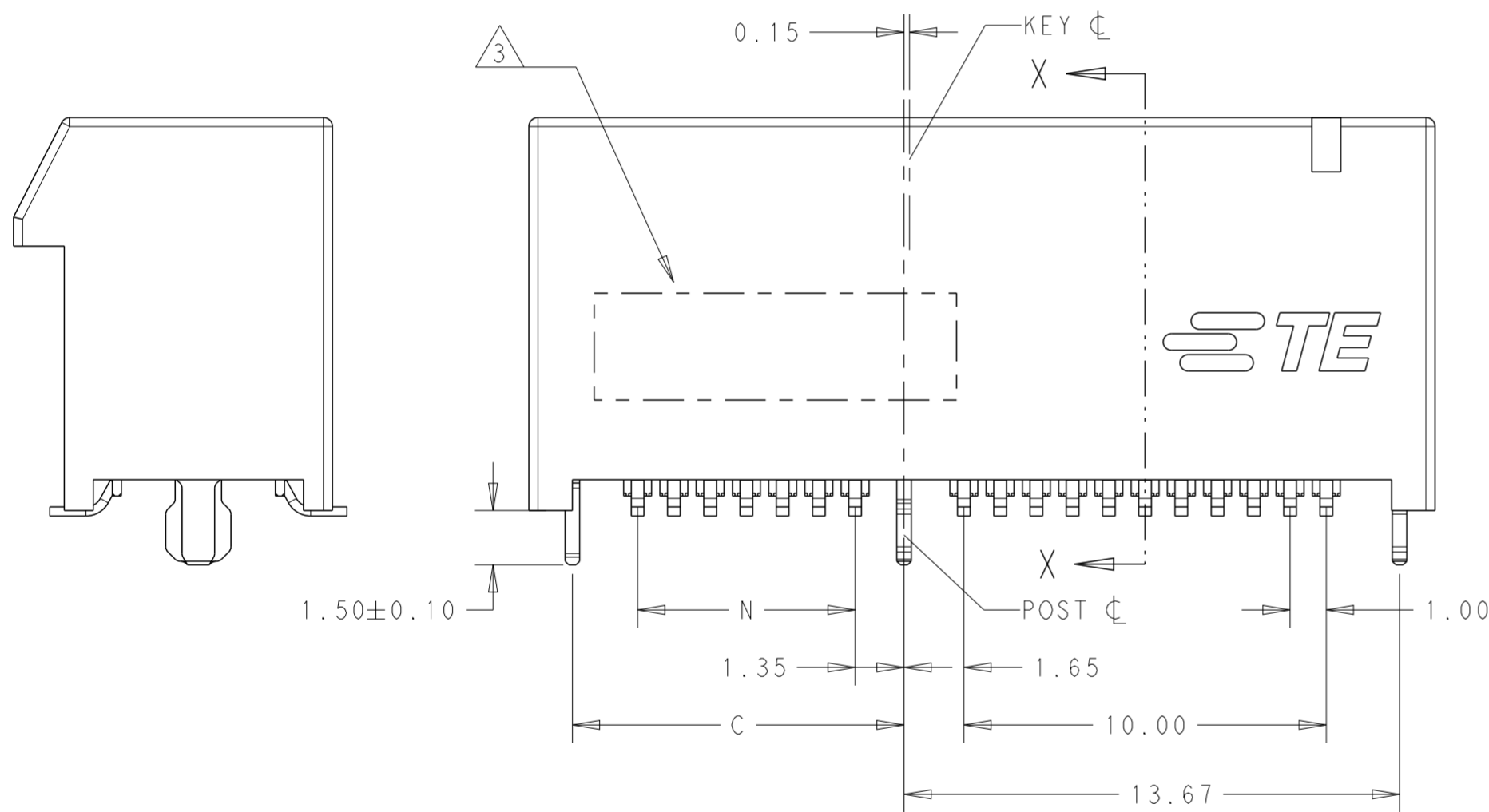

|  |  |                                |   |                        |
|--|--|--------------------------------|---|------------------------|
| THIS DRAWING IS A CONTROLLED DOCUMENT.   |  | DWN<br>TONY LI<br>05NOV2019    | TE Connectivity   |                        |
| DIMENSIONS:<br>mm  |  | CHK<br>ALEX SHOAL<br>05NOV2019 |   |                        |
| TOLERANCES UNLESS OTHERWISE SPECIFIED:   |  | APVD<br>HOPE LU<br>05NOV2019   | NAME<br>PCI EXPRESS GEN4 CARD EDGE CONNECTOR SOLDER TAB |                        |
| 0 PLC $\pm$<br>1 PLC $\pm 0.3$<br>2 PLC $\pm 0.20$<br>3 PLC $\pm 0.050$<br>4 PLC $\pm$<br>ANGLES $\pm$<br>FINISH $\pm$ |  | PRODUCT SPEC<br>-              | SIZE<br>A200779   | CAGE CODE<br>C-2354154 |
| MATERIAL<br>- 1  |  | APPLICATION SPEC<br>-          | DRAWING NO<br>-   | RESTRICTED TO<br>-     |
| -  |  | WEIGHT<br>-                    | SCALE<br>3:1  | SHEET<br>1 OF 5        |
| -  |  | CUSTOMER DRAWING               | REV<br>C  |                        |

THIS DRAWING IS UNPUBLISHED. RELEASED FOR PUBLICATION 20  
 © COPYRIGHT 20 BY - ALL RIGHTS RESERVED.

| REVISIONS |     |             |      |      |
|-----------|-----|-------------|------|------|
| P         | LTR | DESCRIPTION | DATE | APVD |
| -         |     | SEE SHEET 1 | -    | -    |
|           |     |             |      |      |
|           |     |             |      |      |

| PACKAGE        | DESCRIPTION  | W            | V                   | J    | N  | C     | B  | A     | POS. | PART NUMBER |
|----------------|--------------|--------------|---------------------|------|----|-------|----|-------|------|-------------|
| PACKAGE 1      | 108-60121    | 30u"         | 86.5                | 44.5 | 70 | 73.15 | 89 | 71.65 | 164  | 5-2354154-8 |
| PACKAGE 2      | 108-60121    | 30u"         | 53.5                | 28   | 37 | 40.15 | 56 | 38.65 | 98   | 5-2354154-7 |
| PACKAGE 3      | 108-60121    | 30u"         | 36.5                | 19.5 | 20 | 23.15 | 39 | 21.65 | 64   | 5-2354154-6 |
| TBD            | 108-60121    | 30u"         | 22.5                | 12.5 | 6  | 9.15  | 25 | 7.65  | 36   | 5-2354154-5 |
| PACKAGE 1      | 108-60121    | 30u"         | 10.0                | 44.5 | 70 | 73.15 | 89 | 71.65 | 164  | 5-2354154-4 |
| PACKAGE 2      | 108-60121    | 30u"         | 10.0                | 28   | 37 | 40.15 | 56 | 38.65 | 98   | 5-2354154-3 |
| PACKAGE 3      | 108-60121    | 30u"         | 10.0                | 19.5 | 20 | 23.15 | 39 | 21.65 | 64   | 5-2354154-2 |
| TBD            | 108-60121    | 30u"         | 10.0                | 12.5 | 6  | 9.15  | 25 | 7.65  | 36   | 5-2354154-1 |
| PACKAGE 1      | 108-60121-1  | 15u"         | 86.5                | 44.5 | 70 | 73.15 | 89 | 71.65 | 164  | 4-2354154-8 |
| PACKAGE 2      | 108-60121-1  | 15u"         | 53.5                | 28   | 37 | 40.15 | 56 | 38.65 | 98   | 4-2354154-7 |
| PACKAGE 3      | 108-60121-1  | 15u"         | 36.5                | 19.5 | 20 | 23.15 | 39 | 21.65 | 64   | 4-2354154-6 |
| TBD            | 108-60121-1  | 15u"         | 22.5                | 12.5 | 6  | 9.15  | 25 | 7.65  | 36   | 4-2354154-5 |
| PACKAGE 1      | 108-60121-1  | 15u"         | 10.0                | 44.5 | 70 | 73.15 | 89 | 71.65 | 164  | 4-2354154-4 |
| PACKAGE 2      | 108-60121-1  | 15u"         | 10.0                | 28   | 37 | 40.15 | 56 | 38.65 | 98   | 4-2354154-3 |
| PACKAGE 3      | 108-60121-1  | 15u"         | 10.0                | 19.5 | 20 | 23.15 | 39 | 21.65 | 64   | 4-2354154-2 |
| TBD            | 108-60121-1  | 15u"         | 10.0                | 12.5 | 6  | 9.15  | 25 | 7.65  | 36   | 4-2354154-1 |
| PACKAGE 1      | 108-60121-1  | G/F          | 86.5                | 44.5 | 70 | 73.15 | 89 | 71.65 | 164  | 3-2354154-8 |
| PACKAGE 2      | 108-60121-1  | G/F          | 53.5                | 28   | 37 | 40.15 | 56 | 38.65 | 98   | 3-2354154-7 |
| PACKAGE 3      | 108-60121-1  | G/F          | 36.5                | 19.5 | 20 | 23.15 | 39 | 21.65 | 64   | 3-2354154-6 |
| TBD            | 108-60121-1  | G/F          | 22.5                | 12.5 | 6  | 9.15  | 25 | 7.65  | 36   | 3-2354154-5 |
| PACKAGE 1      | 108-60121-1  | G/F          | 10.0                | 44.5 | 70 | 73.15 | 89 | 71.65 | 164  | 3-2354154-4 |
| PACKAGE 2      | 108-60121-1  | G/F          | 10.0                | 28   | 37 | 40.15 | 56 | 38.65 | 98   | 3-2354154-3 |
| PACKAGE 3      | 108-60121-1  | G/F          | 10.0                | 19.5 | 20 | 23.15 | 39 | 21.65 | 64   | 3-2354154-2 |
| TBD            | 108-60121-1  | G/F          | 10.0                | 12.5 | 6  | 9.15  | 25 | 7.65  | 36   | 3-2354154-1 |
| PACKAGE 1      | 108-60121    | 30u"         | NA                  | 44.5 | 70 | 73.15 | 89 | 71.65 | 164  | 2-2354154-4 |
| PACKAGE 2      | 108-60121    | 30u"         | NA                  | 28   | 37 | 40.15 | 56 | 38.65 | 98   | 2-2354154-3 |
| PACKAGE 3      | 108-60121    | 30u"         | NA                  | 19.5 | 20 | 23.15 | 39 | 21.65 | 64   | 2-2354154-2 |
| TBD            | 108-60121    | 30u"         | NA                  | 12.5 | 6  | 9.15  | 25 | 7.65  | 36   | 2-2354154-1 |
| PACKAGE 1      | 108-60121-1  | 15u"         | NA                  | 44.5 | 70 | 73.15 | 89 | 71.65 | 164  | 6-2354154-4 |
| PACKAGE 2      | 108-60121-1  | 15u"         | NA                  | 28   | 37 | 40.15 | 56 | 38.65 | 98   | 6-2354154-3 |
| PACKAGE 3      | 108-60121-1  | 15u"         | NA                  | 19.5 | 20 | 23.15 | 39 | 21.65 | 64   | 6-2354154-2 |
| TBD            | 108-60121-1  | 15u"         | NA                  | 12.5 | 6  | 9.15  | 25 | 7.65  | 36   | 6-2354154-1 |
| PACKAGE 1      | 108-60121-1  | G/F          | NA                  | 44.5 | 70 | 73.15 | 89 | 71.65 | 164  | 2354154-4   |
| PACKAGE 2      | 108-60121-1  | G/F          | NA                  | 28   | 37 | 40.15 | 56 | 38.65 | 98   | 2354154-3   |
| PACKAGE 3      | 108-60121-1  | G/F          | NA                  | 19.5 | 20 | 23.15 | 39 | 21.65 | 64   | 2354154-2   |
| TBD            | 108-60121-1  | G/F          | NA                  | 12.5 | 6  | 9.15  | 25 | 7.65  | 36   | 2354154-1   |
| PACKAGING SPEC | PRODUCT SPEC | GOLD PLATING | W                   | J    | N  | C     | B  | A     | POS. | PART NUMBER |
|                |              |              | MYLAR SIZE (PAGE 4) |      |    |       |    |       |      |             |

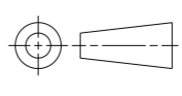
|   |  |                                |   |  |
|---|--|--------------------------------|---|--|
| THIS DRAWING IS A CONTROLLED DOCUMENT.  |  | DWN<br>TONY LI<br>05NOV2019    |  TE Connectivity |  |
| DIMENSIONS:<br>mm   |  | CHK<br>ALEX SHOAL<br>05NOV2019 |   |  |
| TOLERANCES UNLESS OTHERWISE SPECIFIED:  |  | APVD<br>HOPE LU<br>05NOV2019   | NAME<br>PCI EXPRESS GEN4 CARD EDGE CONNECTOR SOLDER TAB   |  |
|    |  | PRODUCT SPEC                   | SIZE  |  |
| 0 PLC ±<br>1 PLC ±0.3<br>2 PLC ±0.20<br>3 PLC ±0.050<br>4 PLC ±<br>ANGLES ±<br>FINISH ± |  | APPLICATION SPEC               | CAGE CODE   |  |
| MATERIAL  |  | WEIGHT                         | DRAWING NO  |  |
|   |  |                                | A200779   |  |
|   |  | CUSTOMER DRAWING               | SCALE 3:1   |  |
|   |  |                                | SHEET 2 OF 5  |  |
|   |  |                                | REV C   |  |

THIS DRAWING IS UNPUBLISHED. RELEASED FOR PUBLICATION 20  
 © COPYRIGHT 20 BY - ALL RIGHTS RESERVED.

| REVISIONS |     |             |      |     |      |
|-----------|-----|-------------|------|-----|------|
| P         | LTR | DESCRIPTION | DATE | DWN | APVD |
| -         | -   | SEE SHEET 1 | -    | -   | -    |
|           |     |             |      |     |      |
|           |     |             |      |     |      |

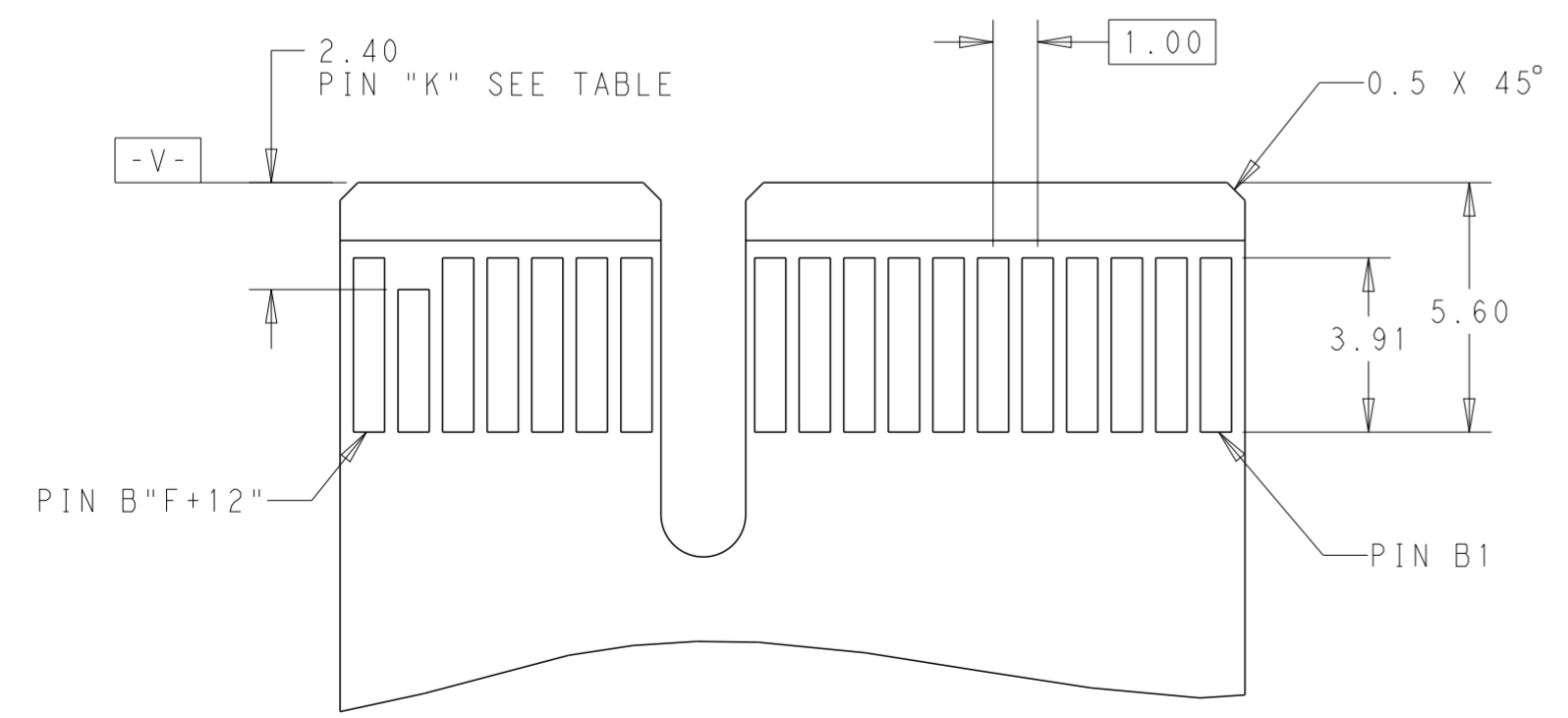
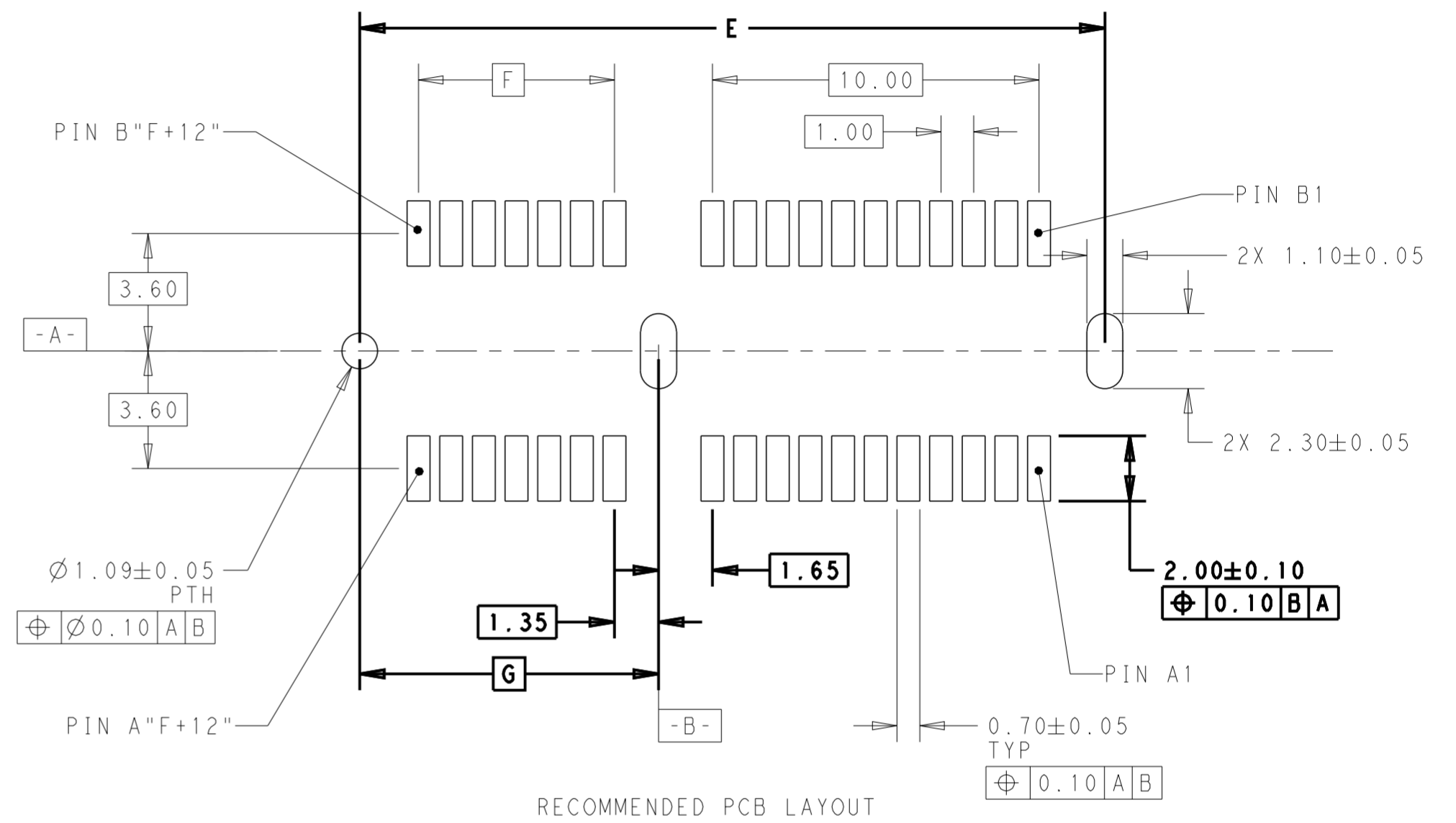
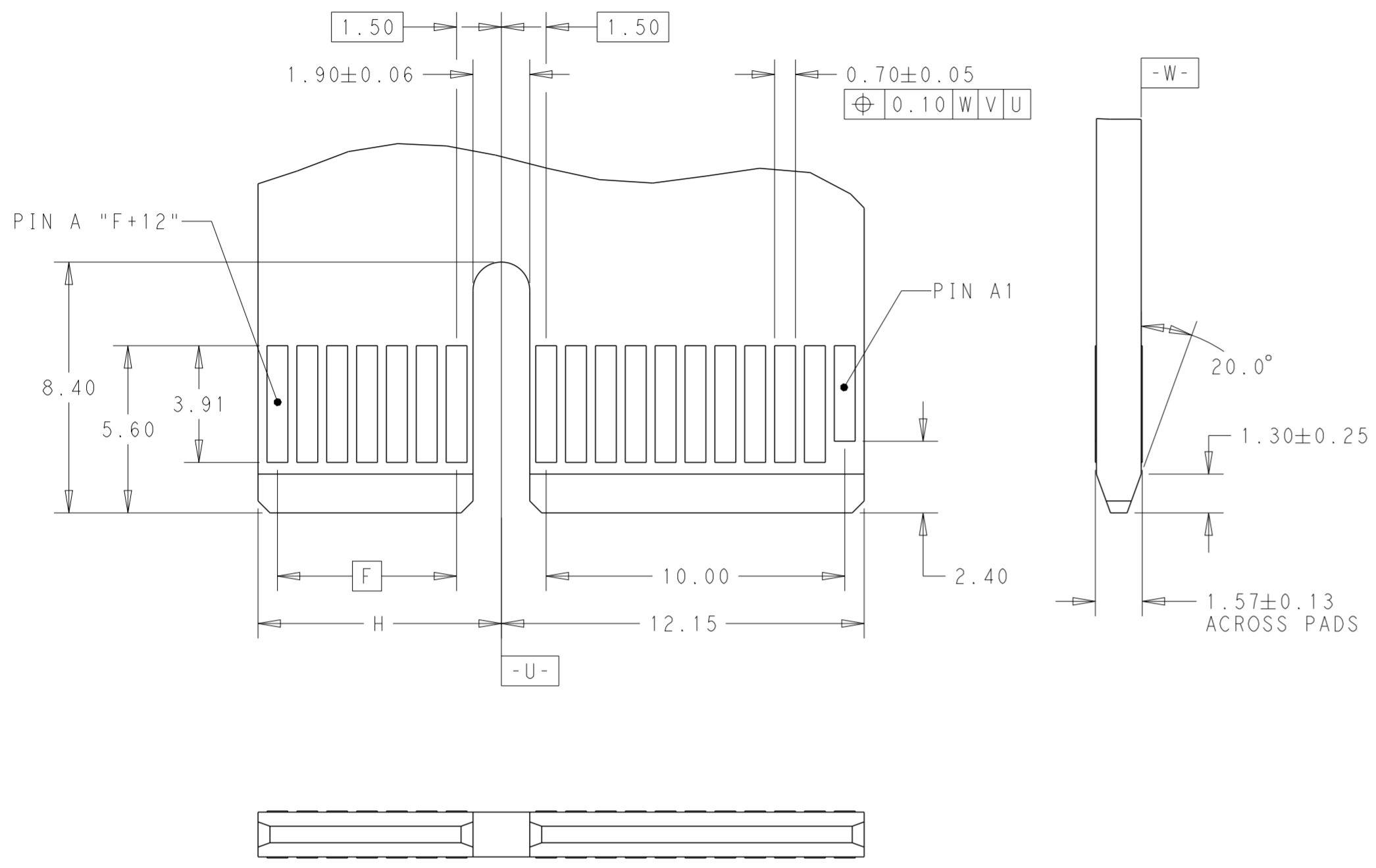

ADD-IN CARD EDGE-FINGER DIMENSION

| POS. | DIM. E | DIM. F | DIM. G | DIM. H | "K"                    |
|------|--------|--------|--------|--------|------------------------|
| 164  | 86.82  | 70     | 73.15  | 72.15  | A1, B17, B31, B48, B81 |
| 98   | 53.82  | 37     | 40.15  | 39.15  | A1, B17, B31, B48      |
| 64   | 36.82  | 20     | 23.15  | 22.15  | A1, B17, B31           |
| 36   | 22.82  | 6      | 9.15   | 8.15   | A1, B17                |

THIS DRAWING IS A CONTROLLED DOCUMENT.

|                |   |   |  |
|----------------|---|---|--|
| DIMENSIONS: mm | TOLERANCES UNLESS OTHERWISE SPECIFIED:<br>0 PLC ±<br>1 PLC ±0.3<br>2 PLC ±0.20<br>3 PLC ±0.050<br>4 PLC ±<br>ANGLES ±<br>FINISH ± | DWN TONY LI 05NOV2019<br>CHK ALEX SHOAL 05NOV2019<br>APVD HOPE LU 05NOV2019 | NAME PCI EXPRESS GEN4 CARD EDGE CONNECTOR SOLDER TAB |
| MATERIAL       |   | PRODUCT SPEC  | SIZE CAGE CODE DRAWING NO RESTRICTED TO              |
|                |   | APPLICATION SPEC  | A200779 C-2354154                                    |
|                |   | WEIGHT  | SCALE 3:1 SHEET 3 OF 5 REV C                         |
|                |   | CUSTOMER DRAWING  |  |

STE TE Connectivity

THIS DRAWING IS UNPUBLISHED. RELEASED FOR PUBLICATION 20  
 © COPYRIGHT 20 BY - ALL RIGHTS RESERVED.

| REVISIONS |     |             |      |      |
|-----------|-----|-------------|------|------|
| P         | LTR | DESCRIPTION | DATE | APVD |
| -         | -   | SEE SHEET 1 | -    | -    |
|           |     |             |      |      |
|           |     |             |      |      |

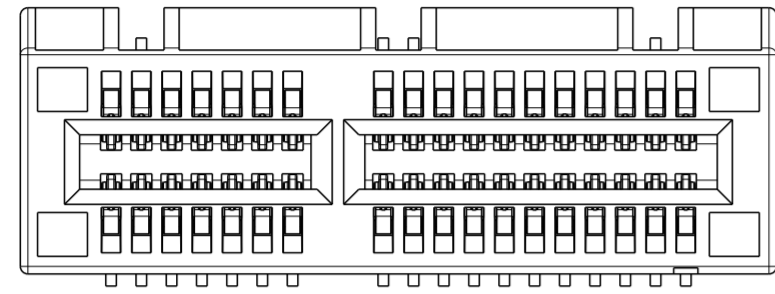

36POS AS SHOWN

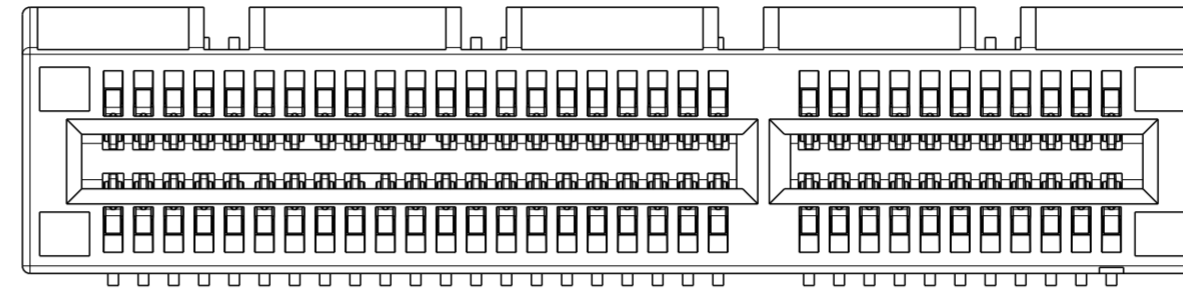

64POS AS SHOWN

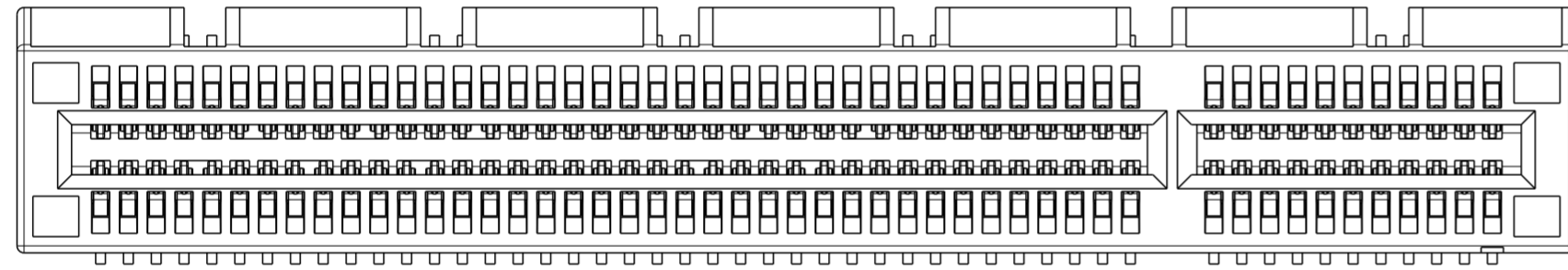

98POS AS SHOWN

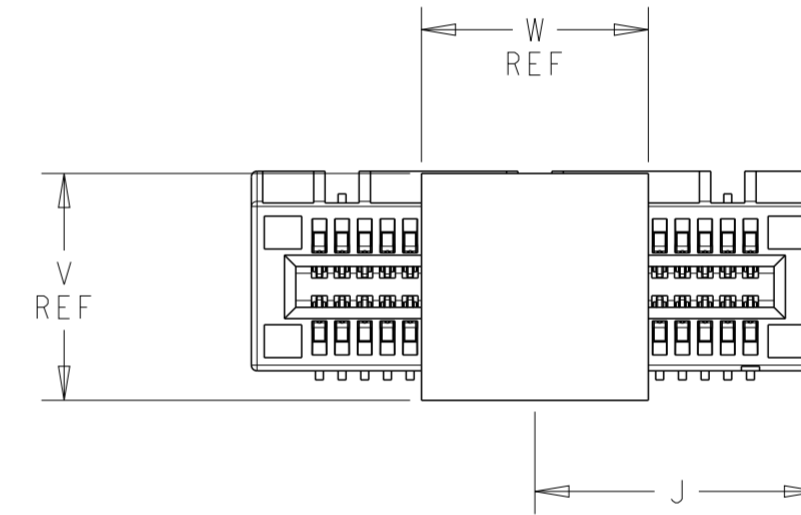

MYLAR SIZE

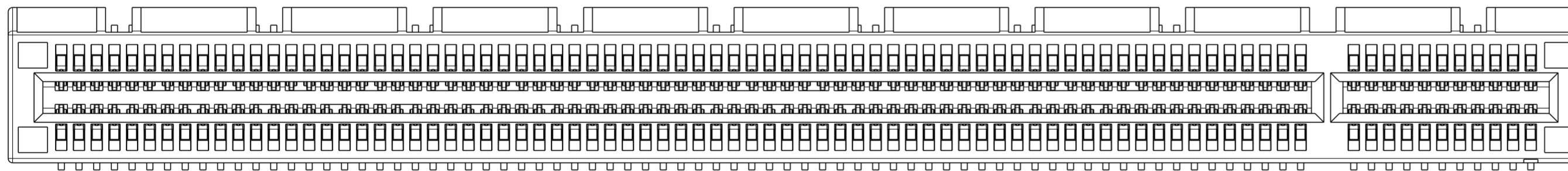

164POS AS SHOWN

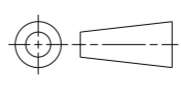
|   |  |                                |   |           |              |               |
|---|--|--------------------------------|---|-----------|--------------|---------------|
| THIS DRAWING IS A CONTROLLED DOCUMENT.  |  | DWN<br>TONY LI<br>05NOV2019    |  TE Connectivity |           |              |               |
| DIMENSIONS:<br>mm   |  | CHK<br>ALEX SHOAL<br>05NOV2019 |   |           |              |               |
|  |  | APVD<br>HOPE LU<br>05NOV2019   | NAME<br>PCI EXPRESS GEN4 CARD EDGE<br>CONNECTOR SOLDER TAB  |           |              |               |
| TOLERANCES UNLESS OTHERWISE SPECIFIED:  |  | PRODUCT SPEC                   | SIZE  | CAGE CODE | DRAWING NO   | RESTRICTED TO |
| 0 PLC ±   |  | APPLICATION SPEC               | A2  | 00779     | C-2354154    | -             |
| 1 PLC ±0.3  |  | WEIGHT                         | SCALE 3:1   |           | SHEET 4 OF 5 | REV C         |
| 2 PLC ±0.20   |  | CUSTOMER DRAWING               |   |           |              |               |
| 3 PLC ±0.050  |  |                                |   |           |              |               |
| 4 PLC ±   |  |                                |   |           |              |               |
| ANGLES ±  |  |                                |   |           |              |               |
| FINISH  |  |                                |   |           |              |               |

THIS DRAWING IS UNPUBLISHED. RELEASED FOR PUBLICATION 20  
 © COPYRIGHT 20 BY - ALL RIGHTS RESERVED.

| REVISIONS |     |             |      |      |
|-----------|-----|-------------|------|------|
| P         | LTR | DESCRIPTION | DATE | APVD |
| -         | -   | SEE SHEET 1 | -    | -    |
|           |     |             |      |      |
|           |     |             |      |      |

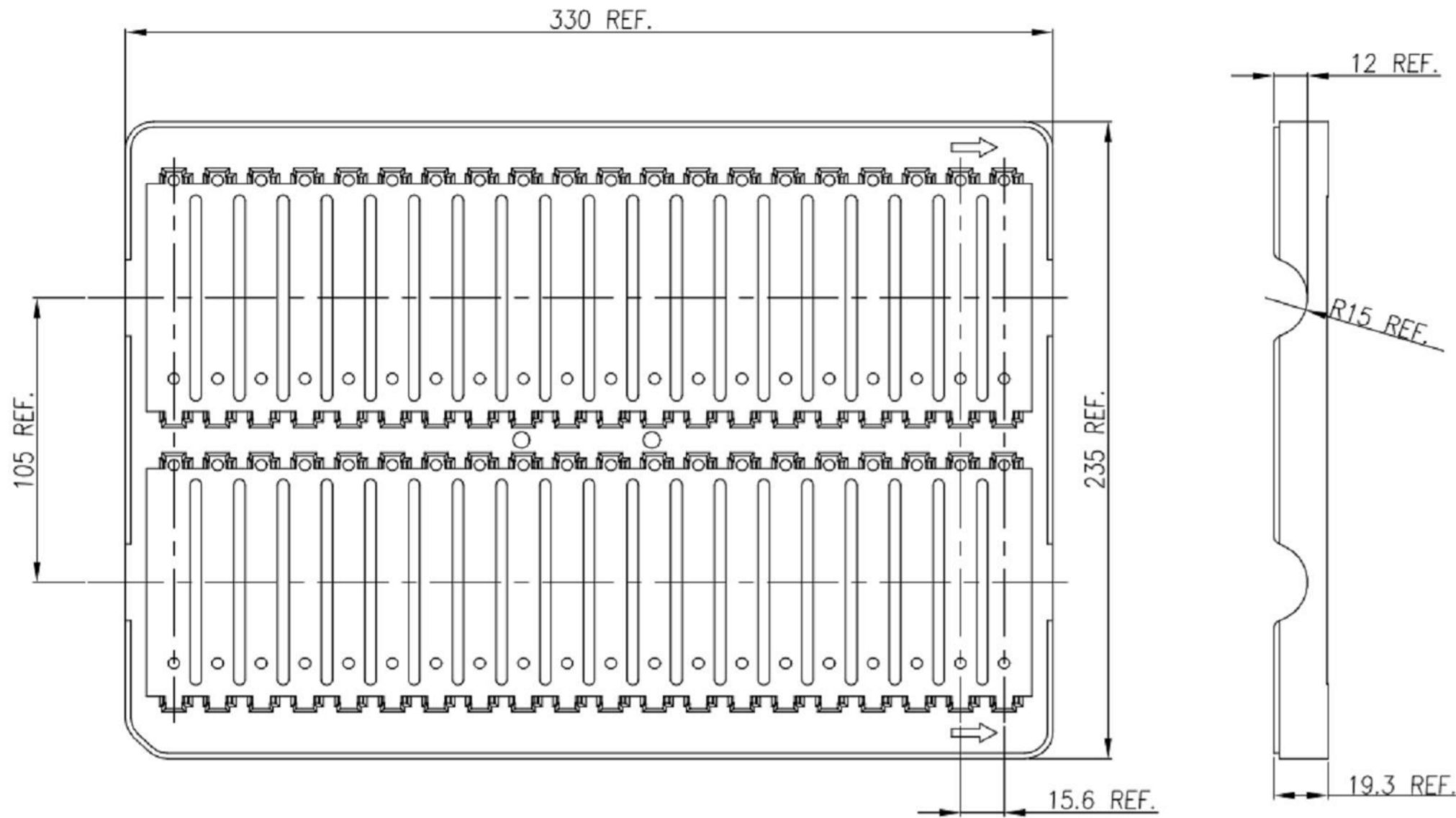

PACKAGE 1

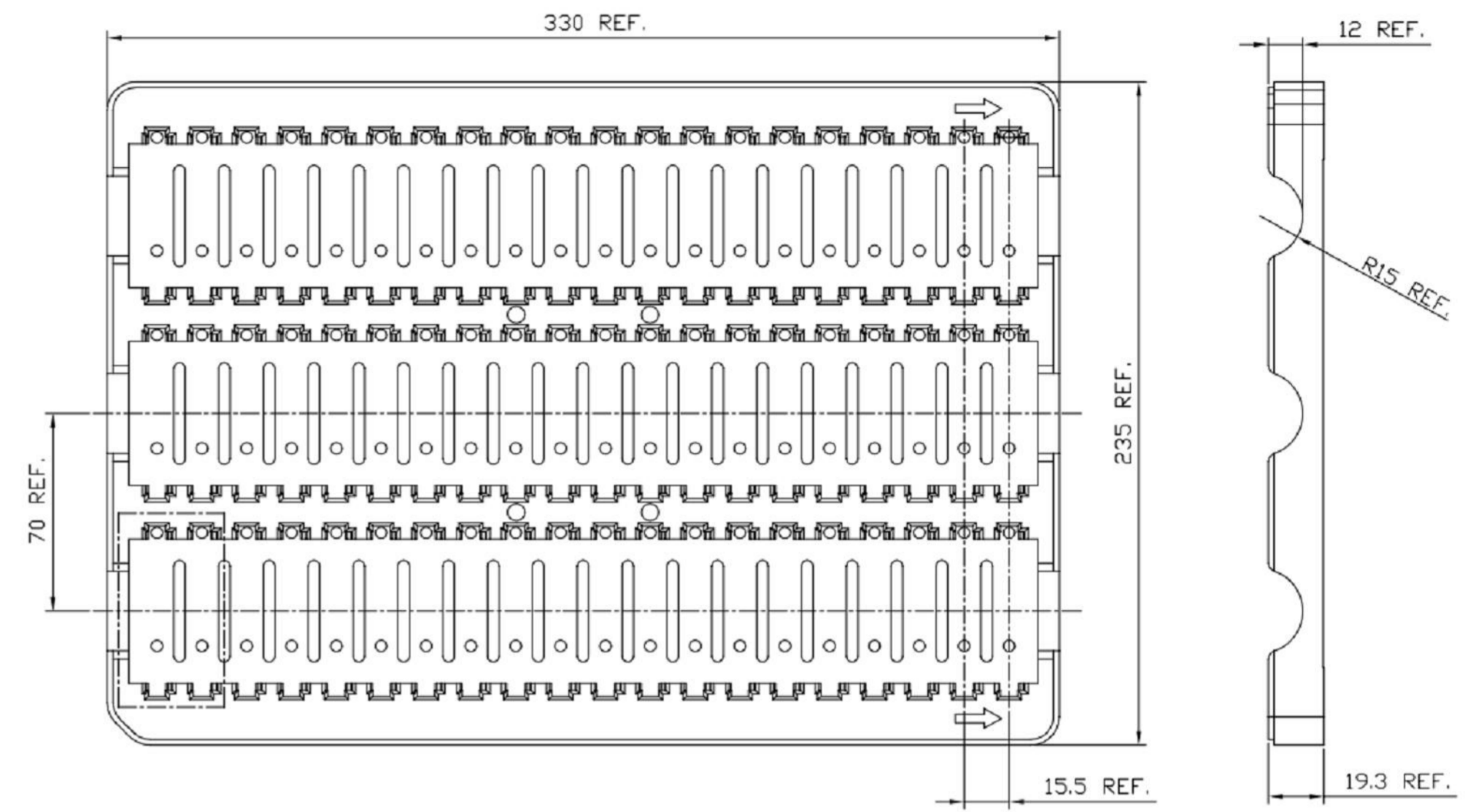

PACKAGE 2

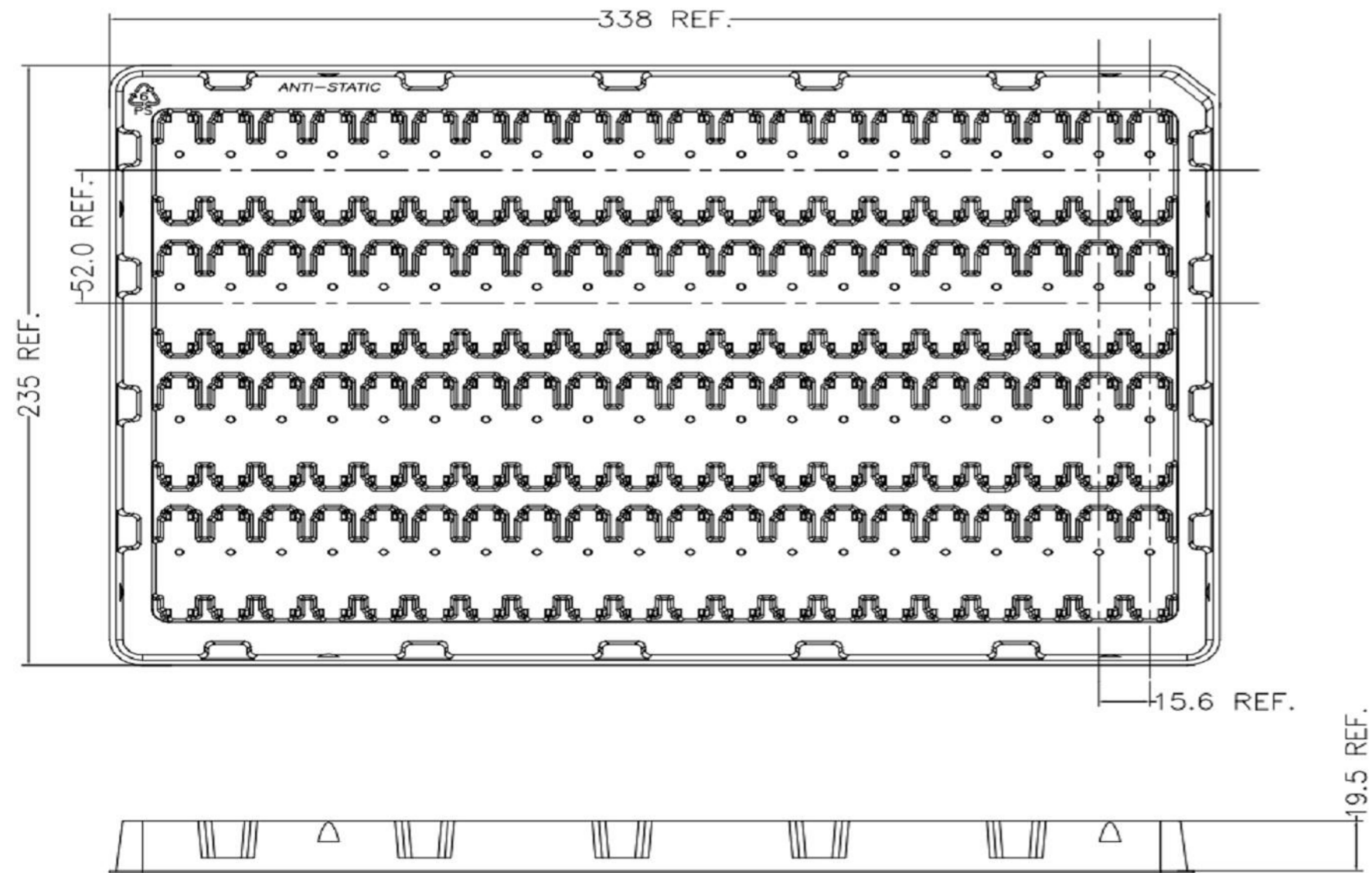

PACKAGE 3

|   |  |   |   |  |                 |               |
|---|--|---|---|--|-----------------|---------------|
| THIS DRAWING IS A CONTROLLED DOCUMENT.  |  | DWN<br>TONY LI<br>05NOV2019                               |  TE Connectivity | NAME<br>PCI EXPRESS GEN4 CARD EDGE<br>CONNECTOR SOLDER TAB |                 |               |
| DIMENSIONS:<br>mm   |  | CHK<br>ALEX SHOAL<br>05NOV2019                            |   | SIZE   | CAGE CODE       | DRAWING NO    |
| TOLERANCES UNLESS OTHERWISE SPECIFIED:  |  | APVD<br>HOPE LU<br>05NOV2019                              |   | A200779  | C-2354154       | RESTRICTED TO |
| 0 PLC ±<br>1 PLC ±0.3<br>2 PLC ±0.20<br>3 PLC ±0.050<br>4 PLC ±<br>ANGLES ±<br>FINISH ± |  | PRODUCT SPEC<br>-<br>APPLICATION SPEC<br>-<br>WEIGHT<br>- |   | SCALE<br>3:1   | SHEET<br>5 OF 5 | REV<br>C      |
| MATERIAL<br>-<br>-  |  | CUSTOMER DRAWING  |   |  |                 |               |